

# MCR08B, MCR08M

Preferred Device

## Sensitive Gate Silicon Controlled Rectifiers

### Reverse Blocking Thyristors

PNPN devices designed for line powered consumer applications such as relay and lamp drivers, small motor controls, gate drivers for larger thyristors, and sensing and detection circuits. Supplied in surface mount package for use in automated manufacturing.

#### Features

- Sensitive Gate Trigger Current
- Blocking Voltage to 600 V
- Glass Passivated Surface for Reliability and Uniformity
- Surface Mount Package
- Pb-Free Packages are Available

#### MAXIMUM RATINGS (T<sub>J</sub> = 25°C unless otherwise noted)

Rating	Symbol	Value	Unit
Peak Repetitive Off-State Voltage (Note 1) (Sine Wave, R <sub>GK</sub> = 1 kΩ T <sub>J</sub> = 25 to 110°C)	V <sub>DRM</sub> , V <sub>RRM</sub>	200 600	V
On-State Current RMS (All Conduction Angles; T <sub>C</sub> = 80°C)	I <sub>T(RMS)</sub>	0.8	A
Peak Non-repetitive Surge Current (1/2 Cycle Sine Wave, 60 Hz, T <sub>C</sub> = 25°C)	I <sub>TSM</sub>	8.0	A
Circuit Fusing Considerations (t = 8.3 ms)	I <sup>2</sup> t	0.4	A <sup>2</sup> s
Forward Peak Gate Power (T <sub>C</sub> = 80°C, t = 1.0 μs)	P <sub>GM</sub>	0.1	W
Average Gate Power (T <sub>C</sub> = 80°C, t = 8.3 ms)	P <sub>G(AV)</sub>	0.01	W
Operating Junction Temperature Range	T <sub>J</sub>	-40 to +110	°C
Storage Temperature Range	T <sub>stg</sub>	-40 to +150	°C

#### THERMAL CHARACTERISTICS

Rating	Symbol	Value	Unit
Thermal Resistance, Junction-to-Ambient PCB Mounted per Figure 1	R <sub>θJA</sub>	156	°C/W
Thermal Resistance, Junction-to-Tab Measured on Anode Tab Adjacent to Epoxy	R <sub>θJT</sub>	25	°C/W
Maximum Device Temperature for Soldering Purposes (for 10 Seconds Maximum)	T <sub>L</sub>	260	°C

Stresses exceeding Maximum Ratings may damage the device. Maximum Ratings are stress ratings only. Functional operation above the Recommended Operating Conditions is not implied. Extended exposure to stresses above the Recommended Operating Conditions may affect device reliability.

1. V<sub>DRM</sub> and V<sub>RRM</sub> for all types can be applied on a continuous basis. Ratings apply for zero or negative gate voltage; however, positive gate voltage shall not be applied concurrent with negative potential on the anode. Blocking voltages shall not be tested with a constant source such that the voltage ratings of the devices are exceeded.



ON Semiconductor®

<http://onsemi.com>

SCRs  
0.8 AMPERES RMS  
200 thru 600 VOLTS



#### MARKING DIAGRAM



SOT-223  
CASE 318E  
STYLE 10

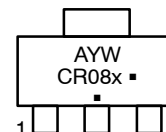

CR08x = Device Code  
x = B or M

A = Assembly Location

Y = Year

W = Work Week

▪ = Pb-Free Package

(Note: Microdot may be in either location)

#### PIN ASSIGNMENT

Pin	Assignment
1	Cathode
2	Anode
3	Gate
4	Anode

#### ORDERING INFORMATION

Device	Package	Shipping†
MCR08BT1	SOT-223	1000/Tape & Reel
MCR08BT1G	SOT-223 (Pb-Free)	1000/Tape & Reel
MCR08MT1	SOT-223	1000/Tape & Reel
MCR08MT1G	SOT-223 (Pb-Free)	1000/Tape & Reel

†For information on tape and reel specifications, including part orientation and tape sizes, please refer to our Tape and Reel Packaging Specifications Brochure, BRD8011/D.

Preferred devices are recommended choices for future use and best overall value.

# MCR08B, MCR08M

## ELECTRICAL CHARACTERISTICS (T<sub>C</sub> = 25°C unless otherwise noted)

Characteristic	Symbol	Min	Typ	Max	Unit
----------------	--------	-----	-----	-----	------

### OFF CHARACTERISTICS

Peak Repetitive Forward or Reverse Blocking Current (Note 3) (V <sub>AK</sub> = Rated V <sub>DRM</sub> or V <sub>RDM</sub> , R <sub>GK</sub> = 1 kΩ)	I <sub>DRM</sub> , I <sub>RDM</sub>	-	-	10	μA
		-	-	200	μA
	T <sub>J</sub> = 25°C				
	T <sub>J</sub> = 110°C				

### ON CHARACTERISTICS

Peak Forward On-State Voltage (Note 2) (I <sub>T</sub> = 1.0 A Peak)	V <sub>TM</sub>	-	-	1.7	V
Gate Trigger Current (Continuous dc) (Note 4) (V <sub>AK</sub> = 12 Vdc, R <sub>L</sub> = 100 Ω)	I <sub>GT</sub>	-	-	200	μA
Holding Current (Note 3) (V <sub>AK</sub> = 12 Vdc, Initiating Current = 20 mA)	I <sub>H</sub>	-	-	5.0	mA
Gate Trigger Voltage (Continuous dc) (Note 4) (V <sub>AK</sub> = 12 Vdc, R <sub>L</sub> = 100 Ω)	V <sub>GT</sub>	-	-	0.8	V

### DYNAMIC CHARACTERISTICS

Critical Rate-of-Rise of Off State Voltage (V <sub>pk</sub> = Rated V <sub>DRM</sub> , T <sub>C</sub> = 110°C, R <sub>GK</sub> = 1 kΩ, Exponential Method)	dv/dt	10	-	-	V/μs
---	-------	----	---	---	------

2. Pulse Test: Pulse Width ≤ 300 μs, Duty Cycle ≤ 2%.
3. R<sub>GK</sub> = 1000 Ω is included in measurement.
4. R<sub>GK</sub> is not included in measurement.

Symbol	Parameter
V <sub>DRM</sub>	Peak Repetitive Off State Forward Voltage
I <sub>DRM</sub>	Peak Forward Blocking Current
V <sub>RDM</sub>	Peak Repetitive Off State Reverse Voltage
I <sub>RDM</sub>	Peak Reverse Blocking Current
V <sub>TM</sub>	Peak On State Voltage
I <sub>H</sub>	Holding Current

### Voltage Current Characteristic of SCR

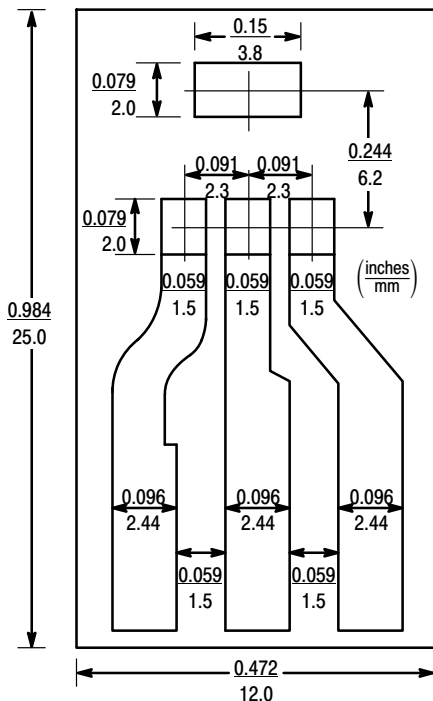
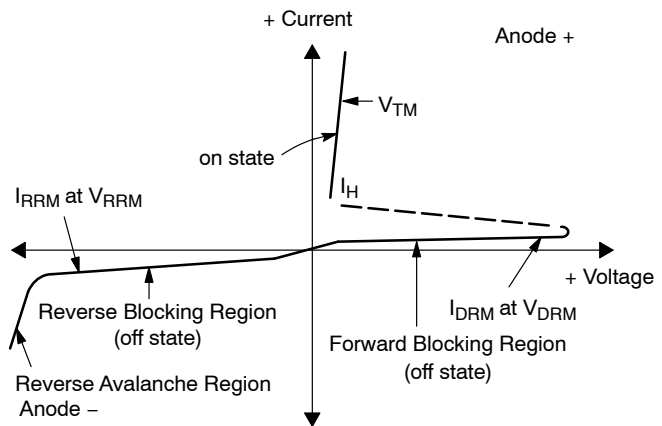

BOARD MOUNTED VERTICALLY IN CINCH 8840 EDGE CONNECTOR.  
 BOARD THICKNESS = 65 MIL., FOIL THICKNESS = 2.5 MIL.  
 MATERIAL: G10 FIBERGLASS BASE EPOXY

Figure 1. PCB for Thermal Impedance and Power Testing of SOT-223

# MCR08B, MCR08M

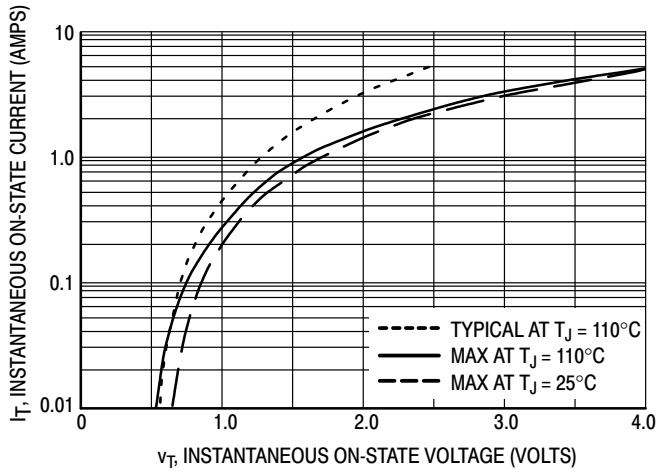

**Figure 2. On-State Characteristics**

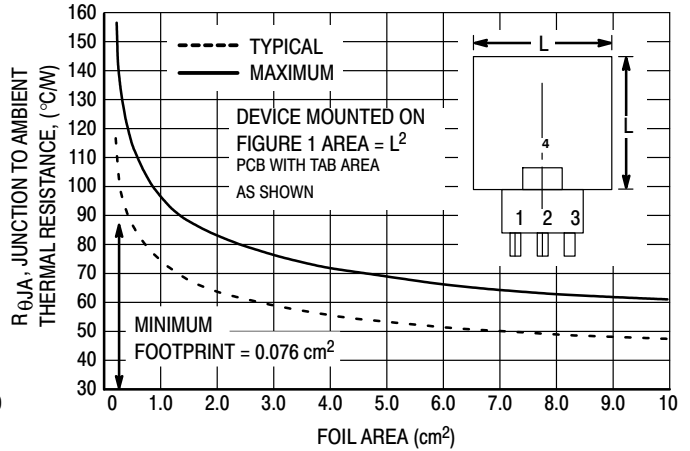

**Figure 3. Junction to Ambient Thermal Resistance versus Copper Tab Area**

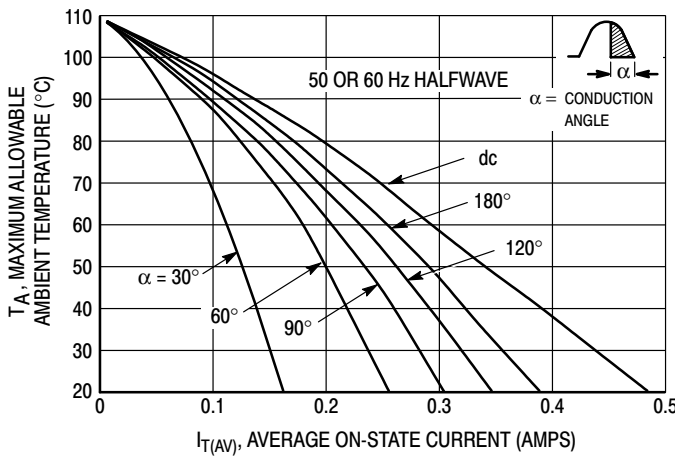

**Figure 4. Current Derating, Minimum Pad Size Reference: Ambient Temperature**

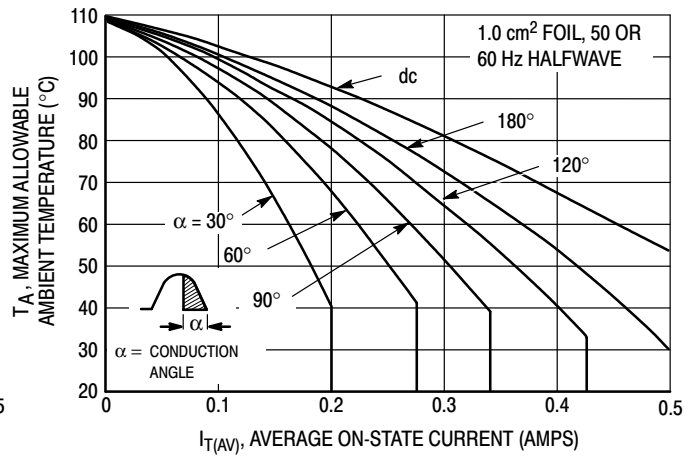

**Figure 5. Current Derating, 1.0 cm Square Pad Reference: Ambient Temperature**

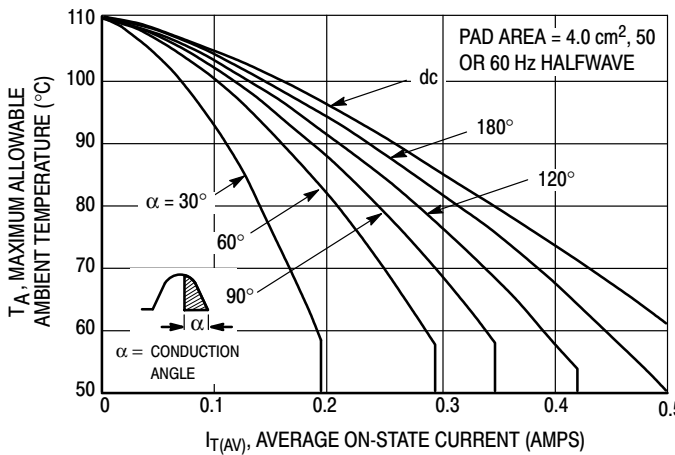

**Figure 6. Current Derating, 2.0 cm Square Pad Reference: Ambient Temperature**

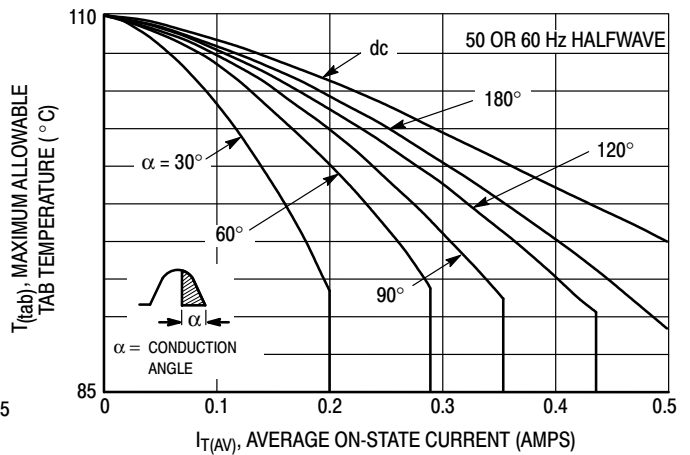

**Figure 7. Current Derating Reference: Anode Tab**

# MCR08B, MCR08M

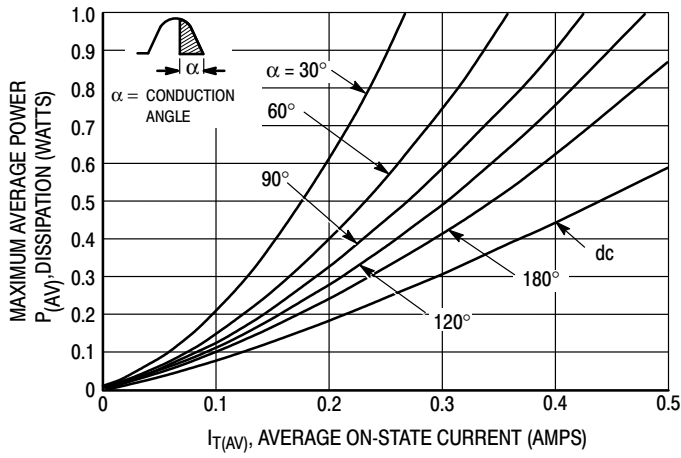

Figure 8. Power Dissipation

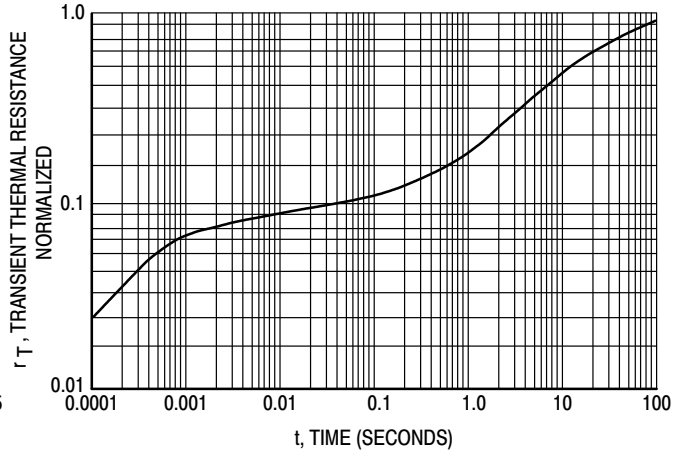

Figure 9. Thermal Response Device Mounted on Figure 1 Printed Circuit Board

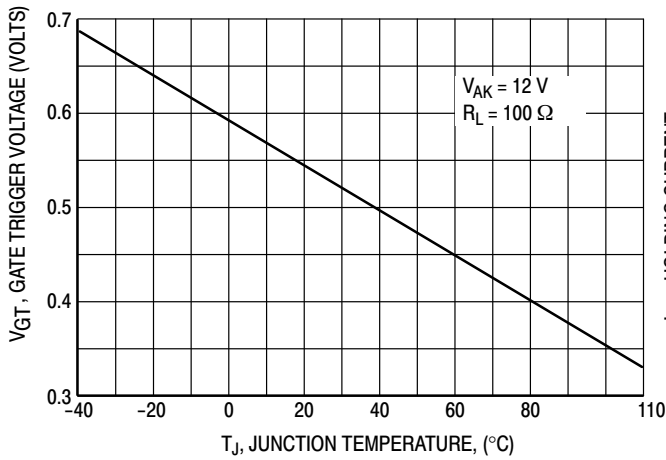

Figure 10. Typical Gate Trigger Voltage versus Junction Temperature

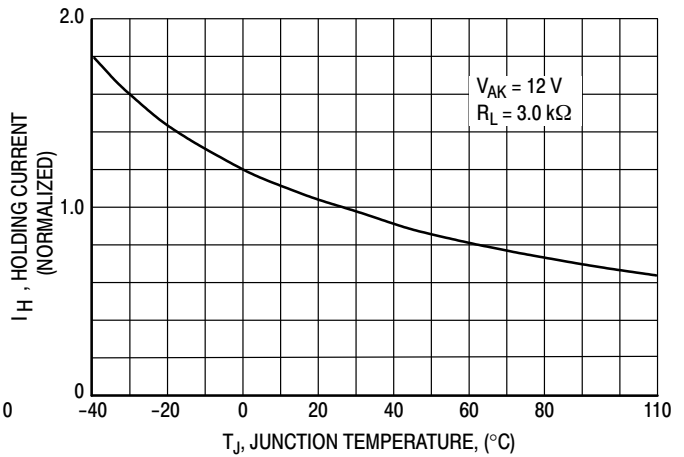

Figure 11. Typical Normalized Holding Current versus Junction Temperature

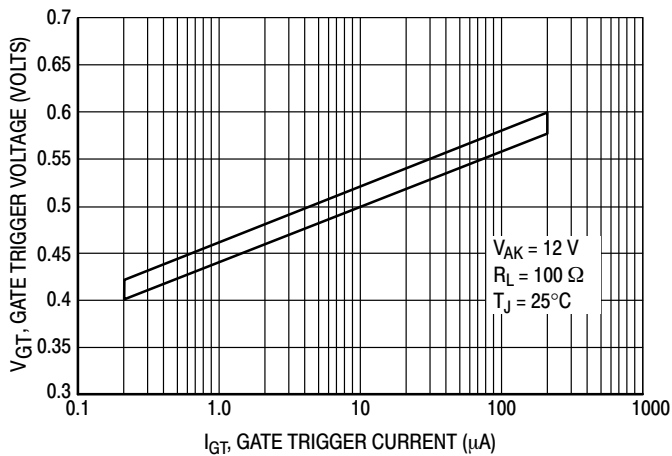

Figure 12. Typical Range of  $V_{GT}$  versus Measured  $I_{GT}$

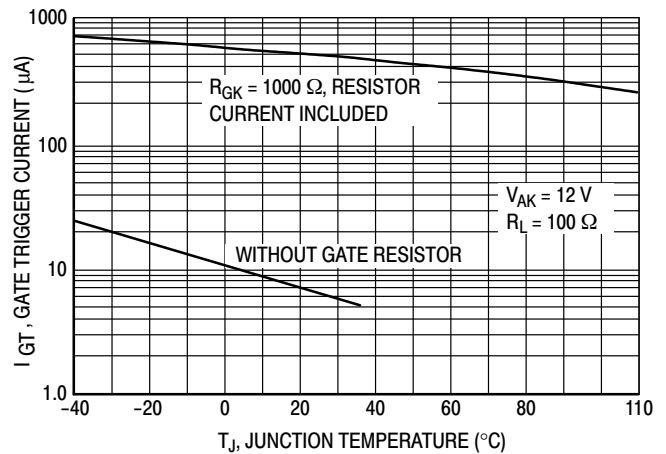
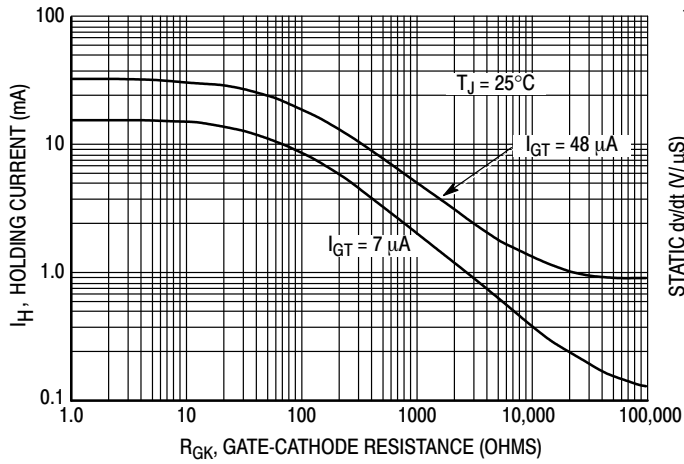
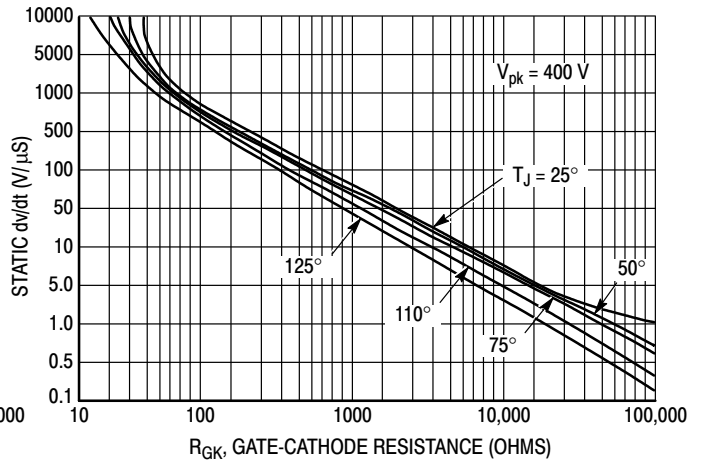

Figure 13. Typical Gate Trigger Current versus Junction Temperature

# MCR08B, MCR08M



**Figure 14. Holding Current Range versus Gate-Cathode Resistance**



**Figure 15. Exponential Static dv/dt versus Junction Temperature and Gate-Cathode Termination Resistance**

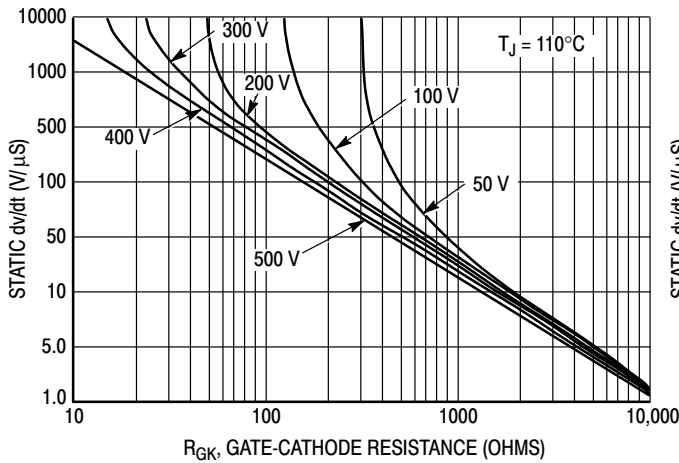

**Figure 16. Exponential Static dv/dt versus Peak Voltage and Gate-Cathode Termination Resistance**

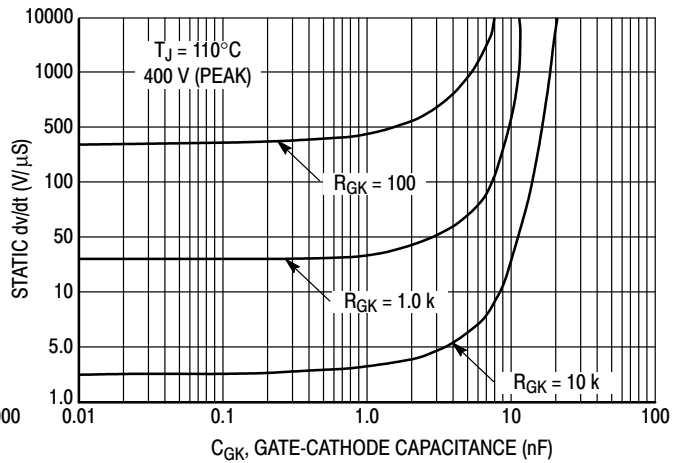

**Figure 17. Exponential Static dv/dt versus Gate-Cathode Capacitance and Resistance**

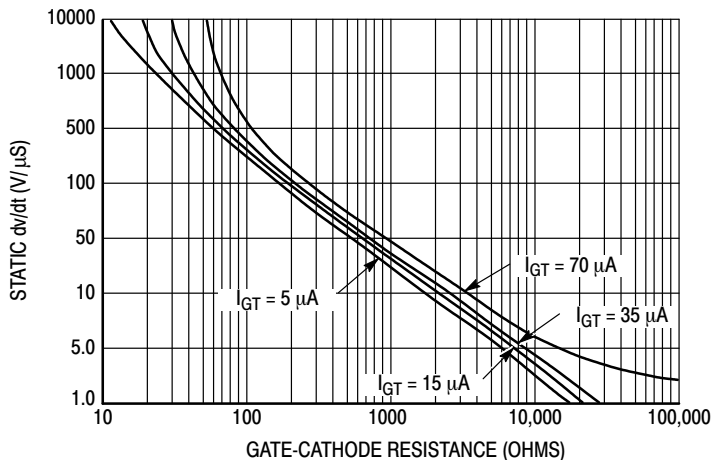

**Figure 18. Exponential Static dv/dt versus Gate-Cathode Termination Resistance and Product Trigger Current Sensitivity**

# MCR08B, MCR08M

## PACKAGE DIMENSIONS

SOT-223 (TO-261)

CASE 318E-04

ISSUE L

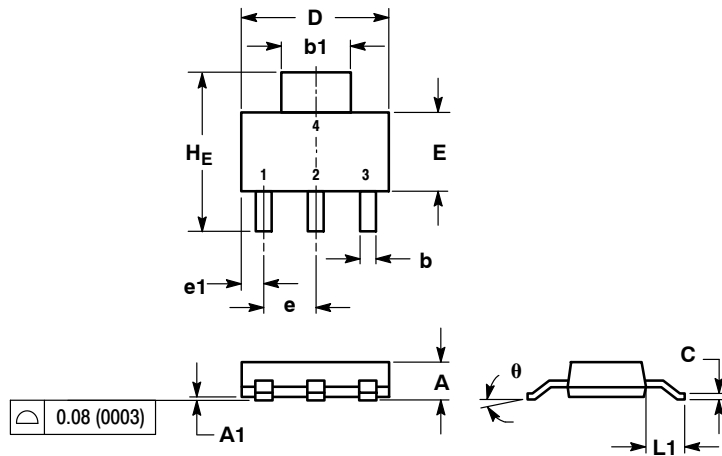

NOTES:

1. DIMENSIONING AND TOLERANCING PER ANSI Y14.5M, 1982.
2. CONTROLLING DIMENSION: INCH.

DIM	MILLIMETERS			INCHES		
	MIN	NOM	MAX	MIN	NOM	MAX
A	1.50	1.63	1.75	0.060	0.064	0.068
A1	0.02	0.06	0.10	0.001	0.002	0.004
b	0.60	0.75	0.89	0.024	0.030	0.035
b1	2.90	3.06	3.20	0.115	0.121	0.126
c	0.24	0.29	0.35	0.009	0.012	0.014
D	6.30	6.50	6.70	0.249	0.256	0.263
E	3.30	3.50	3.70	0.130	0.138	0.145
e	2.20	2.30	2.40	0.087	0.091	0.094
e1	0.85	0.94	1.05	0.033	0.037	0.041
L1	1.50	1.75	2.00	0.060	0.069	0.078
HE	6.70	7.00	7.30	0.264	0.276	0.287
θ	0°	-	10°	0°	-	10°

STYLE 10:

1. CATHODE
2. ANODE
3. GATE
4. ANODE

### SOLDERING FOOTPRINT\*

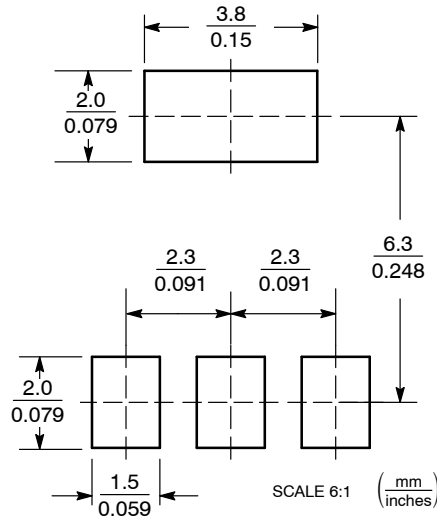

\*For additional information on our Pb-Free strategy and soldering details, please download the ON Semiconductor Soldering and Mounting Techniques Reference Manual, SOLDERRM/D.

ON Semiconductor and are registered trademarks of Semiconductor Components Industries, LLC (SCILLC). SCILLC reserves the right to make changes without further notice to any products herein. SCILLC makes no warranty, representation or guarantee regarding the suitability of its products for any particular purpose, nor does SCILLC assume any liability arising out of the application or use of any product or circuit, and specifically disclaims any and all liability, including without limitation special, consequential or incidental damages. "Typical" parameters which may be provided in SCILLC data sheets and/or specifications can and do vary in different applications and actual performance may vary over time. All operating parameters, including "Typicals" must be validated for each customer application by customer's technical experts. SCILLC does not convey any license under its patent rights nor the rights of others. SCILLC products are not designed, intended, or authorized for use as components in systems intended for surgical implant into the body, or other applications intended to support or sustain life, or for any other application in which the failure of the SCILLC product could create a situation where personal injury or death may occur. Should Buyer purchase or use SCILLC products for any such unintended or unauthorized application, Buyer shall indemnify and hold SCILLC and its officers, employees, subsidiaries, affiliates, and distributors harmless against all claims, costs, damages, and expenses, and reasonable attorney fees arising out of, directly or indirectly, any claim of personal injury or death associated with such unintended or unauthorized use, even if such claim alleges that SCILLC was negligent regarding the design or manufacture of the part. SCILLC is an Equal Opportunity/Affirmative Action Employer. This literature is subject to all applicable copyright laws and is not for resale in any manner.

### PUBLICATION ORDERING INFORMATION

**LITERATURE FULFILLMENT:**  
 Literature Distribution Center for ON Semiconductor  
 P.O. Box 61312, Phoenix, Arizona 85082-1312 USA  
**Phone:** 480-829-7710 or 800-344-3860 Toll Free USA/Canada  
**Fax:** 480-829-7709 or 800-344-3867 Toll Free USA/Canada  
**Email:** orderlit@onsemi.com

**N. American Technical Support:** 800-282-9855 Toll Free  
 USA/Canada

**Japan:** ON Semiconductor, Japan Customer Focus Center  
 2-9-1 Kamimeguro, Meguro-ku, Tokyo, Japan 153-0051  
**Phone:** 81-3-5773-3850

**ON Semiconductor Website:** <http://onsemi.com>

**Order Literature:** <http://www.onsemi.com/litorder>

For additional information, please contact your local Sales Representative.



## Стандарт Электрон Связь

Мы молодая и активно развивающаяся компания в области поставок электронных компонентов. Мы поставляем электронные компоненты отечественного и импортного производства напрямую от производителей и с крупнейших складов мира.

Благодаря сотрудничеству с мировыми поставщиками мы осуществляем комплексные и плановые поставки широчайшего спектра электронных компонентов.

Собственная эффективная логистика и склад в обеспечивает надежную поставку продукции в точно указанные сроки по всей России.

Мы осуществляем техническую поддержку нашим клиентам и предпродажную проверку качества продукции. На все поставляемые продукты мы предоставляем гарантию .

Осуществляем поставки продукции под контролем ВП МО РФ на предприятия военно-промышленного комплекса России , а также работаем в рамках 275 ФЗ с открытием отдельных счетов в уполномоченном банке. Система менеджмента качества компании соответствует требованиям ГОСТ ISO 9001.

Минимальные сроки поставки, гибкие цены, неограниченный ассортимент и индивидуальный подход к клиентам являются основой для выстраивания долгосрочного и эффективного сотрудничества с предприятиями радиоэлектронной промышленности, предприятиями ВПК и научно-исследовательскими институтами России.

С нами вы становитесь еще успешнее!

### Наши контакты:

**Телефон:** +7 812 627 14 35

**Электронная почта:** [sales@st-electron.ru](mailto:sales@st-electron.ru)

**Адрес:** 198099, Санкт-Петербург,  
Промышленная ул, дом № 19, литера Н,  
помещение 100-Н Офис 331