

**FEATURES**

- Standard Voltage:  $V_{DD}$  and  $V_{DDQ} = 1.5V \pm 0.075V$
- Low Voltage (L):  $V_{DD}$  and  $V_{DDQ} = 1.35V + 0.1V, -0.067V$   
- Backward compatible to 1.5V
- High speed data transfer rates with system frequency up to 933 MHz
- 8 internal banks for concurrent operation
- 8n-Bit pre-fetch architecture
- Programmable CAS Latency
- Programmable Additive Latency: 0, CL-1,CL-2
- Programmable CAS WRITE latency (CWL) based on tCK
- Programmable Burst Length: 4 and 8
- Programmable Burst Sequence: Sequential or Interleave
- BL switch on the fly
- Auto Self Refresh(ASR)
- Self Refresh Temperature(SRT)
- Refresh Interval:
  - 7.8 us (8192 cycles/64 ms)  $T_c = -40^{\circ}C$  to  $85^{\circ}C$
  - 3.9 us (8192 cycles/32 ms)  $T_c = 85^{\circ}C$  to  $105^{\circ}C$
- Partial Array Self Refresh
- Asynchronous RESET pin
- TDQS (Termination Data Strobe) supported (x8 only)
- OCD (Off-Chip Driver Impedance Adjustment)
- Dynamic ODT (On-Die Termination)
- Driver strength : RZQ/7, RZQ/6 (RZQ = 240  $\Omega$ )
- Write Leveling
- Up to 200 MHz in DLL off mode
- Operating temperature:
  - Commercial ( $T_c = 0^{\circ}C$  to  $+95^{\circ}C$ )
  - Industrial ( $T_c = -40^{\circ}C$  to  $+95^{\circ}C$ )
  - Automotive, A1 ( $T_c = -40^{\circ}C$  to  $+95^{\circ}C$ )
  - Automotive, A2 ( $T_c = -40^{\circ}C$  to  $+105^{\circ}C$ )

**OPTIONS**

- Configuration:
  - 256Mx8
  - 128Mx16
- Package:
  - 96-ball BGA (9mm x 13mm) for x16
  - 78-ball BGA (8mm x 10.5mm) for x8

**ADDRESS TABLE**

| Parameter                 | 256Mx8  | 128Mx16 |
|---------------------------|---------|---------|
| Row Addressing            | A0-A14  | A0-A13  |
| Column Addressing         | A0-A9   | A0-A9   |
| Bank Addressing           | BA0-2   | BA0-2   |
| Page size                 | 1KB     | 2KB     |
| Auto Precharge Addressing | A10/AP  | A10/AP  |
| BL switch on the fly      | A12/BC# | A12/BC# |

**SPEED BIN**

| Speed Option      | 15H        | 125K       | 107M       | Units |
|-------------------|------------|------------|------------|-------|
| JEDEC Speed Grade | DDR3-1333H | DDR3-1600K | DDR3-1866M |       |
| CL-nRCD-nRP       | 9-9-9      | 11-11-11   | 13-13-13   | tCK   |
| tRCD,tRP(min)     | 13.5       | 13.75      | 13.91      | ns    |

Note: Faster speed options are backward compatible to slower speed options.

Copyright © 2018 Integrated Silicon Solution, Inc. All rights reserved. ISSI reserves the right to make changes to this specification and its products at any time without notice. ISSI assumes no liability arising out of the application or use of any information, products or services described herein. Customers are advised to obtain the latest version of this device specification before relying on any published information and before placing orders for products.

Integrated Silicon Solution, Inc. does not recommend the use of any of its products in life support applications where the failure or malfunction of the product can reasonably be expected to cause failure of the life support system or to significantly affect its safety or effectiveness. Products are not authorized for use in such applications unless Integrated Silicon Solution, Inc. receives written assurance to its satisfaction, that:

- a.) the risk of injury or damage has been minimized;
- b.) the user assume all such risks; and
- c.) potential liability of Integrated Silicon Solution, Inc is adequately protected under the circumstances

1. DDR3 PACKAGE BALLOUT

1.1 DDR3 SDRAM package ballout 78-ball BGA – x8

|   | 1               | 2      | 3    | 4 | 5 | 6 | 7        | 8      | 9    |
|---|-----------------|--------|------|---|---|---|----------|--------|------|
| A | VSS             | VDD    | NC   |   |   |   | NU/TDQS# | VSS    | VDD  |
| B | VSS             | VSSQ   | DQ0  |   |   |   | DM/TDQS  | VSSQ   | VDDQ |
| C | VDDQ            | DQ2    | DQS  |   |   |   | DQ1      | DQ3    | VSSQ |
| D | VSSQ            | DQ6    | DQS# |   |   |   | VDD      | VSS    | VSSQ |
| E | VREFDQ          | VDDQ   | DQ4  |   |   |   | DQ7      | DQ5    | VDDQ |
| F | NC <sup>1</sup> | VSS    | RAS# |   |   |   | CK       | VSS    | NC   |
| G | ODT             | VDD    | CAS# |   |   |   | CK#      | VDD    | CKE  |
| H | NC              | CS#    | WE#  |   |   |   | A10/AP   | ZQ     | NC   |
| J | VSS             | BA0    | BA2  |   |   |   | NC(A15)  | VREFCA | VSS  |
| K | VDD             | A3     | A0   |   |   |   | A12/BC#  | BA1    | VDD  |
| L | VSS             | A5     | A2   |   |   |   | A1       | A4     | VSS  |
| M | VDD             | A7     | A9   |   |   |   | A11      | A6     | VDD  |
| N | VSS             | RESET# | A13  |   |   |   | A14      | A8     | VSS  |

Note:  
NC balls have no internal connection. NC(A15) is one of NC pins and reserved for higher densities.

**IS43/46TR16128C, IS43/46TR16128CL,  
IS43/46TR82560C, IS43/46TR82560CL**

**1.2 DDR3 SDRAM package ballout 96-ball BGA – x16**

|   | 1      | 2      | 3     | 4 | 5 | 6 | 7       | 8      | 9    |
|---|--------|--------|-------|---|---|---|---------|--------|------|
| A | VDDQ   | DQU5   | DQU7  |   |   |   | DQU4    | VDDQ   | VSS  |
| B | VSSQ   | VDD    | VSS   |   |   |   | DQSU#   | DQU6   | VSSQ |
| C | VDDQ   | DQU3   | DQU1  |   |   |   | DQSU    | DQU2   | VDDQ |
| D | VSSQ   | VDDQ   | DMU   |   |   |   | DQU0    | VSSQ   | VDD  |
| E | VSS    | VSSQ   | DQL0  |   |   |   | DML     | VSSQ   | VDDQ |
| F | VDDQ   | DQL2   | DQSL  |   |   |   | DQL1    | DQL3   | VSSQ |
| G | VSSQ   | DQL6   | DQSL# |   |   |   | VDD     | VSS    | VSSQ |
| H | VREFDQ | VDDQ   | DQL4  |   |   |   | DQL7    | DQL5   | VDDQ |
| J | NC     | VSS    | RAS#  |   |   |   | CK      | VSS    | NC   |
| K | ODT    | VDD    | CAS#  |   |   |   | CK#     | VDD    | CKE  |
| L | NC     | CS#    | WE#   |   |   |   | A10/AP  | ZQ     | NC   |
| M | VSS    | BA0    | BA2   |   |   |   | NC(A15) | VREFCA | VSS  |
| N | VDD    | A3     | A0    |   |   |   | A12/BC# | BA1    | VDD  |
| P | VSS    | A5     | A2    |   |   |   | A1      | A4     | VSS  |
| R | VDD    | A7     | A9    |   |   |   | A11     | A6     | VDD  |
| T | VSS    | RESET# | A13   |   |   |   | NC(A14) | A8     | VSS  |

Note:

NC balls have no internal connection. NC(A14) and NC(A15) are one of NC pins and reserved for higher densities.

### 1.3 Pinout Description - JEDEC Standard

| Symbol                              | Type           | Function  |
|-------------------------------------|----------------|---|
| CK, CK#                             | Input          | Clock: CK and CK# are differential clock inputs. All address and control input signals are sampled on the crossing of the positive edge of CK and negative edge of CK#.   |
| CKE                                 | Input          | Clock Enable: CKE HIGH activates, and CKE Low deactivates, internal clock signals and device input buffers and output drivers. Taking CKE Low provides Precharge Power-Down and Self-Refresh operation (all banks idle), or Active Power-Down (row Active in any bank). CKE is asynchronous for Self-Refresh exit. After VREFCA and VREFDQ have become stable during the power on and initialization sequence, they must be maintained during all operations (including Self-Refresh). CKE must be maintained high throughout read and write accesses. Input buffers, excluding CK, CK#, ODT and CKE, are disabled during power-down. Input buffers, excluding CKE, are disabled during Self-Refresh. |
| CS#                                 | Input          | Chip Select: All commands are masked when CS# is registered HIGH. CS# provides for external Rank selection on systems with multiple Ranks. CS# is considered part of the command code.  |
| ODT                                 | Input          | On Die Termination: ODT (registered HIGH) enables termination resistance internal to the DDR3 SDRAM. When enabled, ODT is only applied to each DQ, DQSU, DQSU#, DQSL, DQSL#, DMU, and DML signal. The ODT pin will be ignored if MR1 and MR2 are programmed to disable RTT.   |
| RAS#. CAS#. WE#                     | Input          | Command Inputs: RAS#, CAS# and WE# (along with CS#) define the command being entered.   |
| DM, (DMU), (DML)                    | Input          | Input Data Mask: DM is an input mask signal for write data. Input data is masked when DM is sampled HIGH coincident with that input data during a Write access. DM is sampled on both edges of DQS. For x8 device, the function of DM or TDQS/TDQS# is enabled by Mode Register A11 setting in MR1.   |
| BA0 - BA2                           | Input          | Bank Address Inputs: BA0 - BA2 define to which bank an Active, Read, Write, or Precharge command is being applied. Bank address also determines which mode register is to be accessed during a MRS cycle.   |
| A0 - A14                            | Input          | Address Inputs: Provide the row address for Active commands and the column address for Read/ Write commands to select one location out of the memory array in the respective bank. (A10/AP and A12/BC# have additional functions; see below). The address inputs also provide the op-code during Mode Register Set commands.  |
| A10 / AP                            | Input          | Auto-precharge: A10 is sampled during Read/Write commands to determine whether Autoprecharge should be performed to the accessed bank after the Read/Write operation. (HIGH: Autoprecharge; LOW: no Autoprecharge). A10 is sampled during a Precharge command to determine whether the Precharge applies to one bank (A10 LOW) or all banks (A10 HIGH). If only one bank is to be precharged, the bank is selected by bank addresses.   |
| A12 / BC#                           | Input          | Burst Chop: A12 / BC# is sampled during Read and Write commands to determine if burst chop (on-the-fly) will be performed. (HIGH, no burst chop; LOW: burst chopped). See command truth table for details.  |
| RESET#                              | Input          | Active Low Asynchronous Reset: Reset is active when RESET# is LOW, and inactive when RESET# is HIGH. RESET# must be HIGH during normal operation. RESET# is a CMOS rail-to-rail signal with DC high and low at 80% and 20% of VDD, i.e., 1.20V for DC high and 0.30V for DC low.  |
| DQ( DQL, DQU)                       | Input / Output | Data Input/ Output: Bi-directional data bus.  |
| DQS, DQS#, DQSU, DQSU#, DQSL, DQSL# | Input / Output | Data Strobe: output with read data, input with write data. Edge-aligned with read data, centered in write data. For the x16, DQSL corresponds to the data on DQL0-DQL7; DQSU corresponds to the data on DQU0-DQU7. The data strobes DQS, DQSL, and DQSU are paired with differential signals DQS#, DQSL#, and DQSU#, respectively, to provide differential pair signaling to the system during reads and writes. DDR3 SDRAM supports differential data strobe only and does not support single-ended.   |
| TDQS, TDQS#                         | Output         | Termination Data Strobe: TDQS/TDQS# is applicable for x8 DRAMs only. When enabled via Mode Register A11 = 1 in MR1, the DRAM will enable the same termination resistance function on TDQS/TDQS# that is applied to DQS/DQS#. When disabled via mode register A11 = 0 in MR1, DM/TDQS will provide the data mask function and TDQS# is not used. x16 DRAMs must disable the TDQS function via mode register A11 = 0 in MR1.  |

**IS43/46TR16128C, IS43/46TR16128CL,  
IS43/46TR82560C, IS43/46TR82560CL**



|        |        |   |
|--------|--------|---|
| NC     |        | No Connect: No internal electrical connection is present.                                       |
| VDDQ   | Supply | DQ Power Supply: 1.5 V +/- 0.075 V for standard voltage or 1.35V +0.1V, -0.067V for low voltage |
| VSSQ   | Supply | DQ Ground   |
| VDD    | Supply | Power Supply: 1.5 V +/- 0.075 V for standard voltage or 1.35V +0.1V, -0.067V for low voltage    |
| VSS    | Supply | Ground  |
| VREFDQ | Supply | Reference voltage for DQ  |
| VREFCA | Supply | Reference voltage for CA  |
| ZQ     | Supply | Reference Pin for ZQ calibration  |

Note: Input only pins (BA0-BA2, A0-A14, RAS#, CAS#, WE#, CS#, CKE, ODT, and RESET#) do not supply termination.

2. FUNCTION DESCRIPTION

2.1 Simplified State Diagram



| Abbreviation | Function            | Abbreviation | Function              | Abbreviation | Function               |
|--------------|---------------------|--------------|-----------------------|--------------|------------------------|
| ACT          | Active              | Read         | RD, RDS4, RDS8        | PDE          | Enter Power-down       |
| PRE          | Precharge           | Read A       | RDA, RDAS4, RDAS8     | PDX          | Exit Power-down        |
| PREA         | Precharge All       | Write        | WR, WRS4, WRS8        | SRE          | Self-Refresh entry     |
| MRS          | Mode Register Set   | Write A      | WRA, WRAS4, WRAS8     | SRX          | Self-Refresh exit      |
| REF          | Refresh             | RESET        | Start RESET Procedure | MPR          | Multi-Purpose Register |
| ZQCL         | ZQ Calibration Long | ZQCS         | ZQ Calibration Short  |              |                        |

---

## 2.2 RESET and Initialization Procedure

### 2.2.1 Power-up Initialization Sequence

The following sequence is required for POWER UP and Initialization.

1. Apply power (RESET# is recommended to be maintained below  $0.2 \times VDD$ ; all other inputs may be undefined). RESET# needs to be maintained for minimum 200 us with stable power. CKE is pulled "Low" anytime before RESET# being de-asserted (min. time 10 ns). The power voltage ramp time between 300mV to VDD(min) must be no greater than 200 ms; and during the ramp,  $VDD > VDDQ$  and  $(VDD - VDDQ) < 0.3$  volts.
  - VDD and VDDQ are driven from a single power converter output, AND
  - The voltage levels on all pins other than VDD, VDDQ, VSS, VSSQ must be less than or equal to VDDQ and VDD on one side and must be larger than or equal to VSSQ and VSS on the other side. In addition, VTT is limited to 0.95 V max once power ramp is finished, AND
  - Vref tracks  $VDDQ/2$ .

OR

- Apply VDD without any slope reversal before or at the same time as VDDQ.
  - Apply VDDQ without any slope reversal before or at the same time as VTT & Vref.
  - The voltage levels on all pins other than VDD, VDDQ, VSS, VSSQ must be less than or equal to VDDQ and VDD on one side and must be larger than or equal to VSSQ and VSS on the other side.
2. After RESET# is de-asserted, wait for another 500 us until CKE becomes active. During this time, the DRAM will start internal state initialization; this will be done independently of external clocks.
  3. Clocks (CK, CK#) need to be started and stabilized for at least 10 ns or 5 tCK (which is larger) before CKE goes active. Since CKE is a synchronous signal, the corresponding set up time to clock (tIS) must be met. Also, a NOP or Deselect command must be registered (with tIS set up time to clock) before CKE goes active. Once the CKE is registered "High" after Reset, CKE needs to be continuously registered "High" until the initialization sequence is finished, including expiration of tDLLK and tZQinit.
  4. The DDR3 SDRAM keeps its on-die termination in high-impedance state as long as RESET# is asserted. Further, the SDRAM keeps its on-die termination in high impedance state after RESET# deassertion until CKE is registered HIGH. The ODT input signal may be in undefined state until tIS before CKE is registered HIGH. When CKE is registered HIGH, the ODT input signal may be statically held at either LOW or HIGH. If RTT\_NOM is to be enabled in MR1, the ODT input signal must be statically held LOW. In all cases, the ODT input signal remains static until the power up initialization sequence is finished, including the expiration of tDLLK and tZQinit.
  5. After CKE is being registered high, wait minimum of Reset CKE Exit time, tXPR, before issuing the first MRS command to load mode register. ( $tXPR = \max(tXS ; 5 \times tCK)$ )
  6. Issue MRS Command to load MR2 with all application settings. (To issue MRS command for MR2, provide "Low" to BA0 and BA2, "High" to BA1.)
  7. Issue MRS Command to load MR3 with all application settings. (To issue MRS command for MR3, provide "Low" to BA2, "High" to BA0 and BA1.)
  8. Issue MRS Command to load MR1 with all application settings and DLL enabled. (To issue "DLL Enable" command, provide "Low" to A0, "High" to BA0 and "Low" to BA1 – BA2).
  9. Issue MRS Command to load MR0 with all application settings and "DLL reset". (To issue DLL reset command, provide "High" to A8 and "Low" to BA0-2).

10. Issue ZQCL command to starting ZQ calibration.
11. Wait for both tDLLK and tZQinit completed.
12. The DDR3 SDRAM is now ready for normal operation.



Note1. From time point “Td” until “Tk” NOP or DES commands must be applied between MRS and ZQCL commands.

(( ))' Time Break  
□ DON'T CARE

Figure2.1.1 Reset and Initialization Sequence at Power-on Ramping

### 2.2.2 Reset Initialization with Stable Power

The following sequence is required for RESET at no power interruption initialization.



- 1 Asserted RESET below  $0.2 * VDD$  anytime when reset is needed (all other inputs may be undefined). RESET needs to be maintained for minimum 100 ns. CKE is pulled "LOW" before RESET being de-asserted (min. time 10 ns).
- 2 Follow Power-up Initialization Sequence steps 2 to 11.
- 3 The Reset sequence is now completed; DDR3 SDRAM is ready for normal operation



Note1. From time point "Td" until "Tk" NOP or DES commands must be applied between MRS and ZQCL commands.

(( )) Time Break  
□ DON'T CARE

**Figure2.1.2 Reset Procedure at Power Stable Condition**

## 2.3 Register Definition

### 2.3.1 Programming the Mode Registers

For application flexibility, various functions, features, and modes are programmable in four Mode Registers, provided by the DDR3 SDRAM, as user defined variables and they must be programmed via a Mode Register Set (MRS) command. As the default values of the Mode Registers (MR#) are not defined, contents of Mode Registers must be fully initialized and/or re-initialized, i.e. written, after power up and/or reset for proper operation. Also the contents of the Mode Registers can be altered by re-executing the MRS command during normal operation. When programming the mode registers, even if the user chooses to modify only a sub-set of the MRS fields, all address fields within the accessed mode register must be redefined when the MRS command is issued. MRS command and DLL Reset do not affect array contents, which means these commands can be executed any time after power-up without affecting the array contents. The mode register set command cycle time, tMRD is required to complete the write operation to the mode register and is the minimum time required between two MRS commands shown as below.

CK#



Figure 2.3.1a tMRD Timing

The MRS command to Non-MRS command delay, tMOD, is required for the DRAM to update the features except DLL reset, and is the minimum time required from an MRS command to a non-MRS command excluding NOP and DES shown as the following figure.



Figure 2.3.1b tMOD Timing

The mode register contents can be changed using the same command and timing requirements during normal operation as long as the DRAM is in idle state, i.e., all banks are in the precharged state with tRP satisfied, all data bursts are completed and CKE is high prior to writing into the mode register. If the RTT\_NOM Feature is enabled in the Mode Register prior and/or after an MRS Command, the ODT Signal must continuously be registered LOW ensuring RTT is in an off State prior to the MRS command. The ODT Signal maybe registered high after tMOD has expired. If the RTT\_NOM Feature is disabled in the Mode Register prior and after an MRS command, the ODT Signal can be registered either LOW or HIGH before, during and after the MRS command. The mode registers are divided into various fields depending on the functionality and/or modes.

### 2.3.2 Mode Register MR0

The mode register MR0 stores the data for controlling various operating modes of DDR3 SDRAM. It controls burst length, read burst type, CAS latency, test mode, DLL reset, WR and DLL control for precharge Power-Down, which include vendor specific options to make DDR3 SDRAM useful for various applications. The mode register is written by asserting low on CS#, RAS#, CAS#, WE#, BA0, BA1, and BA2, while controlling the states of address pins according to the following figure.

|     |     |     |         |     |     |     |    |     |    |             |    |    |     |    |    |    |                 |
|-----|-----|-----|---------|-----|-----|-----|----|-----|----|-------------|----|----|-----|----|----|----|-----------------|
| BA2 | BA1 | BA0 | A14-A13 | A12 | A11 | A10 | A9 | A8  | A7 | A6          | A5 | A4 | A3  | A2 | A1 | A0 | Address Field   |
| 0   | 0   | 0   | 0*1     | PPD | WR  |     |    | DLL | TM | CAS Latency |    |    | RBT | CL | BL |    | Mode Register 0 |

|    |           |
|----|-----------|
| A8 | DLL Reset |
| 0  | No        |
| 1  | Yes       |

|    |        |
|----|--------|
| A7 | mode   |
| 0  | Normal |
| 1  | Test   |

|    |                   |
|----|-------------------|
| A3 | Read Burst Type   |
| 0  | Nibble Sequential |
| 1  | Interleave        |

|    |    |                       |
|----|----|-----------------------|
| A1 | A0 | BL                    |
| 0  | 0  | 8 (Fixed)             |
| 0  | 1  | BC4 or 8 (on the fly) |
| 1  | 0  | BC4 (Fixed)           |
| 1  | 1  | Reserved              |

|     |                              |
|-----|------------------------------|
| A12 | DLL Control for Precharge PD |
| 0   | Slow exit (DLL off)          |
| 1   | Fast exit (DLL on)           |

Write recovery for autoprecharge

|     |     |    |                  |
|-----|-----|----|------------------|
| A11 | A10 | A9 | WR(cycles)       |
| 0   | 0   | 0  | Reserved         |
| 0   | 0   | 1  | 5 <sup>*2</sup>  |
| 0   | 1   | 0  | 6 <sup>*2</sup>  |
| 0   | 1   | 1  | 7 <sup>*2</sup>  |
| 1   | 0   | 0  | 8 <sup>*2</sup>  |
| 1   | 0   | 1  | 10 <sup>*2</sup> |
| 1   | 1   | 0  | 12 <sup>*2</sup> |
| 1   | 1   | 1  | 14 <sup>*2</sup> |

|     |     |           |
|-----|-----|-----------|
| BA1 | BA0 | MR Select |
| 0   | 0   | MR0       |
| 0   | 1   | MR1       |
| 1   | 0   | MR2       |
| 1   | 1   | MR3       |

|    |    |    |    |             |
|----|----|----|----|-------------|
| A6 | A5 | A4 | A2 | CAS Latency |
| 0  | 0  | 0  | 0  | Reserved    |
| 0  | 0  | 1  | 0  | 5           |
| 0  | 1  | 0  | 0  | 6           |
| 0  | 1  | 1  | 0  | 7           |
| 1  | 0  | 0  | 0  | 8           |
| 1  | 0  | 1  | 0  | 9           |
| 1  | 1  | 0  | 0  | 10          |
| 1  | 1  | 1  | 0  | 11          |
| 0  | 0  | 0  | 1  | 12          |
| 0  | 0  | 1  | 1  | 13          |
| 0  | 1  | 0  | 1  | 14          |
| 0  | 1  | 1  | 1  | Reserved    |
| 1  | 0  | 0  | 1  | Reserved    |
| 1  | 0  | 1  | 1  | Reserved    |
| 1  | 1  | 0  | 1  | Reserved    |
| 1  | 1  | 1  | 1  | Reserved    |

- A14 and A13 must be programmed to 0 during MRS.
- WR (write recovery for autoprecharge)min in clock cycles is calculated by dividing tWR(in ns) by tCK(in ns) and rounding up to the next integer: WRmin[cycles] = Roundup(tWR[ns] / tCK[ns]). The WR value in the mode register must be programmed to be equal or larger than WRmin. The programmed WR value is used with tRP to determine tDAL.
- The table only shows the encodings for a given Cas Latency. For actual supported Cas Latency, please refer to speedbin tables for each frequency
- The table only shows the encodings for Write Recovery. For actual Write recovery timing, please refer to AC timing table.

Figure 2.3.2 — MR0 Definition

#### 2.3.2.1 Burst Length, Type and Order

Accesses within a given burst may be programmed to sequential or interleaved order. The burst type is selected via bit A3 as shown in Figure 2.3.2. The ordering of accesses within a burst is determined by the burst length, burst type, and the starting column address as shown in Table below. The burst length is defined by bits A0-A1. Burst length options include fixed BC4, fixed BL8, and 'on the fly' which allows BC4 or BL8 to be selected coincident with the registration of a Read or Write command via A12/BC#.

| Burst Length | READ/<br>WRITE | Starting Column ADDRESS (A2,A1,A0) | burst type = Sequential (decimal) A3 = 0 | burst type = Interleaved (decimal) A3 = 1 | Notes      |
|--------------|----------------|------------------------------------|--|---|------------|
| 4 Chop       | READ           | 0                                  | 0,1,2,3,T,T,T,T                          | 0,1,2,3,T,T,T,T                           | 1, 2, 3    |
|              |                | 1                                  | 1,2,3,0,T,T,T,T                          | 1,0,3,2,T,T,T,T                           | 1, 2, 3    |
|              |                | 10                                 | 2,3,0,1,T,T,T,T                          | 2,3,0,1,T,T,T,T                           | 1, 2, 3    |
|              |                | 11                                 | 3,0,1,2,T,T,T,T                          | 3,2,1,0,T,T,T,T                           | 1, 2, 3    |
|              |                | 100                                | 4,5,6,7,T,T,T,T                          | 4,5,6,7,T,T,T,T                           | 1, 2, 3    |
|              |                | 101                                | 5,6,7,4,T,T,T,T                          | 5,4,7,6,T,T,T,T                           | 1, 2, 3    |
|              |                | 110                                | 6,7,4,5,T,T,T,T                          | 6,7,4,5,T,T,T,T                           | 1, 2, 3    |
|              | 111            | 7,4,5,6,T,T,T,T                    | 7,6,5,4,T,T,T,T                          | 1, 2, 3                                   |            |
|              | WRITE          | 0,V,V                              | 0,1,2,3,X,X,X,X                          | 0,1,2,3,X,X,X,X                           | 1, 2, 4, 5 |
| 1,V,V        |                | 4,5,6,7,X,X,X,X                    | 4,5,6,7,X,X,X,X                          | 1, 2, 4, 5                                |            |
| 8            | READ           | 0                                  | 0,1,2,3,4,5,6,7                          | 0,1,2,3,4,5,6,7                           | 2          |
|              |                | 1                                  | 1,2,3,0,5,6,7,4                          | 1,0,3,2,5,4,7,6                           | 2          |
|              |                | 10                                 | 2,3,0,1,6,7,4,5                          | 2,3,0,1,6,7,4,5                           | 2          |
|              |                | 11                                 | 3,0,1,2,7,4,5,6                          | 3,2,1,0,7,6,5,4                           | 2          |
|              |                | 100                                | 4,5,6,7,0,1,2,3                          | 4,5,6,7,0,1,2,3                           | 2          |
|              |                | 101                                | 5,6,7,4,1,2,3,0                          | 5,4,7,6,1,0,3,2                           | 2          |
|              |                | 110                                | 6,7,4,5,2,3,0,1                          | 6,7,4,5,2,3,0,1                           | 2          |
|              | 111            | 7,4,5,6,3,0,1,2                    | 7,6,5,4,3,2,1,0                          | 2   |            |
|              | WRITE          | V,V,V                              | 0,1,2,3,4,5,6,7                          | 0,1,2,3,4,5,6,7                           | 2, 4       |

- Notes:
- In case of burst length being fixed to 4 by MR0 setting, the internal write operation starts two clock cycles earlier than for the BL8 mode. This means that the starting point for tWR and tWTR will be pulled in by two clocks. In case of burst length being selected on-the-fly via A12/BC#, the internal write operation starts at the same point in time like a burst of 8 write operation. This means that during on-the-fly control, the starting point for tWR and tWTR will not be pulled in by two clocks.
  - 0...7 bit number is value of CA[2:0] that causes this bit to be the first read during a burst.
  - T: Output driver for data and strobes are in high impedance.
  - V: a valid logic level (0 or 1), but respective buffer input ignores level on input pins.
  - X: Don't Care.

### 2.3.2.2 CAS Latency

The CAS Latency is defined by MR0 (bits A9-A11) as shown in Figure 2.3.2. CAS Latency is the delay, in clock cycles, between the internal Read command and the availability of the first bit of output data. DDR3 SDRAM does not support any half-clock latencies. The overall Read Latency (RL) is defined as Additive Latency (AL) + CAS Latency (CL);  $RL = AL + CL$ . For more information on the supported CL and AL settings based on the operating clock frequency, refer to "Standard Speed Bins".

### 2.3.2.3 Test Mode

The normal operating mode is selected by MR0 (bit A7 = 0) and all other bits set to the desired values shown in Figure 2.3.2. Programming bit A7 to a '1' places the DDR3 SDRAM into a test mode that is only used by the DRAM Manufacturer and should NOT be used. No operations or functionality is specified if A7 = 1.

### 2.3.2.4 DLL Reset

The DLL Reset bit is self-clearing, meaning that it returns back to the value of '0' after the DLL reset function has been issued. Once the DLL is enabled, a subsequent DLL Reset should be applied. Any time that the DLL reset function is used, tDLLK must be met before any functions that require the DLL can be used (i.e., Read commands or ODT synchronous operations).

### 2.3.2.5 Write Recovery

The programmed WR value MR0 (bits A9, A10, and A11) is used for the auto precharge feature along with tRP to determine tDAL. WR (write recovery for auto-precharge) min in clock cycles is calculated by dividing tWR (in ns) by tCK (in ns) and rounding up to the next integer:  $WR_{min}[cycles] = \text{Roundup}(tWR[ns]/tCK[ns])$ . The WR must be programmed to be equal to or larger than tWR(min).

### 2.3.2.6 Precharge PD DLL

MR0 (bit A12) is used to select the DLL usage during precharge power-down mode. When MR0 (A12 = 0), or 'slow-exit', the DLL is frozen after entering precharge power-down (for potential power savings) and upon exit requires tXPDLL to be met prior to the next valid command. When MR0 (A12 = 1), or 'fast-exit', the DLL is maintained after entering precharge power-down and upon exiting power-down requires tXP to be met prior to the next valid command.

### 2.3.3 Mode Register MR1

The Mode Register MR1 stores the data for enabling or disabling the DLL, output driver strength, Rtt\_Nom impedance, additive latency, Write leveling enable, TDQS enable and Qoff. The Mode Register 1 is written by asserting low on CS#, RAS#, CAS#, WE#, high on BA0 and low on BA1 and BA2, while controlling the states of address pins according to Figure 2.3.3.

|     |     |     |         |      |      |     |     |     |       |     |       |    |     |       |     |    |                 |
|-----|-----|-----|---------|------|------|-----|-----|-----|-------|-----|-------|----|-----|-------|-----|----|-----------------|
| BA2 | BA1 | BA0 | A14-A13 | A12  | A11  | A10 | A9  | A8  | A7    | A6  | A5    | A4 | A3  | A2    | A1  | A0 | Address Field   |
| 0   | 0   | 1   | 0*1     | Qoff | TDQS | 0*1 | Rtt | 0*1 | Level | Rtt | D.I.C | AL | Rtt | D.I.C | DLL |    | Mode Register 1 |

|     |             |
|-----|-------------|
| A11 | TDQS enable |
| 0   | Disabled    |
| 1   | Enabled     |

|    |                       |
|----|-----------------------|
| A7 | Write leveling enable |
| 0  | Disabled              |
| 1  | Enabled               |

|    |    |                  |
|----|----|------------------|
| A4 | A3 | Additive Latency |
| 0  | 0  | 0 (AL disabled)  |
| 0  | 1  | CL-1             |
| 1  | 0  | CL-2             |
| 1  | 1  | Reserved         |

|    |    |    |              |
|----|----|----|--------------|
| A9 | A6 | A2 | Rtt_Nom *3   |
| 0  | 0  | 0  | ODT disabled |
| 0  | 0  | 1  | RZQ/4        |
| 0  | 1  | 0  | RZQ/2        |
| 0  | 1  | 1  | RZQ/6        |
| 1  | 0  | 0  | RZQ/12*4     |
| 1  | 0  | 1  | RZQ/8*4      |
| 1  | 1  | 0  | Reserved     |
| 1  | 1  | 1  | Reserved     |

|    |            |
|----|------------|
| A0 | DLL Enable |
| 0  | Enable     |
| 1  | Disable    |

|     |                           |
|-----|---------------------------|
| A12 | Qoff *2                   |
| 0   | Output buffer enabled     |
| 1   | Output buffer disabled *2 |

\*2: Outputs disabled - DQs, DQSs, DQS#s.

|     |     |           |
|-----|-----|-----------|
| BA1 | BA0 | MR Select |
| 0   | 0   | MR0       |
| 0   | 1   | MR1       |
| 1   | 0   | MR2       |
| 1   | 1   | MR3       |

Note: RZQ = 240 Ω

\*3: In Write leveling Mode (MR1[bit7] = 1) with MR1[bit12]=1, all RTT\_Nom settings are allowed; in Write Leveling Mode (MR1[bit7] = 1) with MR1[bit12]=0, only RTT\_Nom settings of RZQ/2, RZQ/4 and RZQ/6 are allowed.

\*4: If RTT\_Nom is used during Writes, only the values RZQ/2, RZQ/4 and RZQ/6 are allowed.

|    |    |                                 |
|----|----|---------------------------------|
| A5 | A1 | Output Driver Impedance Control |
| 0  | 0  | RZQ/6                           |
| 0  | 1  | RZQ/7                           |
| 1  | 0  | Reserved                        |
| 1  | 1  | Reserved                        |

\* 1 : A8, A10, A13, and A14 must be programmed to 0 during MRS.

\* TDQS must be disabled for x16 option.

Figure 2.3.3 MR1 Definition

#### 2.3.3.1 DLL Enable/Disable

The DLL must be enabled for normal operation. DLL enable is required during power up initialization, and upon returning to normal operation after having the DLL disabled. During normal operation (DLL-on) with MR1 (A0 = 0), the DLL is automatically disabled when entering Self-Refresh operation and is automatically re-enabled upon exit of Self-Refresh operation. Any time the DLL is enabled and subsequently reset, tDLLK clock cycles must occur before a Read or synchronous ODT command can be issued to allow time for the internal clock to be synchronized with the external clock. Failing to wait for synchronization to occur may result in a violation of the tDQSCK, tAON or tAOF parameters. During tDLLK, CKE must continuously be registered high. DDR3 SDRAM does not require DLL for any Write operation, except

when RTT\_WR is enabled and the DLL is required for proper ODT operation. For more detailed information on DLL Disable operation refer to “DLL-off Mode”.

The direct ODT feature is not supported during DLL-off mode. The on-die termination resistors must be disabled by continuously registering the ODT pin low and/or by programming the RTT\_Nom bits MR1{A9,A6,A2} to {0,0,0} via a mode register set command during DLL-off mode.

The dynamic ODT feature is not supported at DLL-off mode. User must use MRS command to set Rtt\_WR, MR2 {A10, A9} = {0,0}, to disable Dynamic ODT externally.

### 2.3.3.2 Output Driver Impedance Control

The output driver impedance of the DDR3 SDRAM device is selected by MR1 (bits A1 and A5) as shown in Figure 2.3.3.

### 2.3.3.3 ODT Rtt Values

DDR3 SDRAM is capable of providing two different termination values (Rtt\_Nom and Rtt\_WR). The nominal termination value Rtt\_Nom is programmed in MR1. A separate value (Rtt\_WR) may be programmed in MR2 to enable a unique RTT value when ODT is enabled during writes. The Rtt\_WR value can be applied during writes even when Rtt\_Nom is disabled.

### 2.3.3.4 Additive Latency (AL)

Additive Latency (AL) operation is supported to make command and data bus efficient for sustainable bandwidths in DDR3 SDRAM. In this operation, the DDR3 SDRAM allows a read or write command (either with or without auto-precharge) to be issued immediately after the active command. The command is held for the time of the Additive Latency (AL) before it is issued inside the device. The Read Latency (RL) is controlled by the sum of the AL and CAS Latency (CL) register settings. Write Latency (WL) is controlled by the sum of the AL and CAS Write Latency (CWL) register settings. A summary of the AL register options are shown in Table below.

| A4 | A3 | Additive Latency (AL) Settings |
|----|----|--------------------------------|
| 0  | 0  | 0 (AL Disabled)                |
| 0  | 1  | CL - 1                         |
| 1  | 0  | CL - 2                         |
| 1  | 1  | Reserved                       |

NOTE: AL has a value of CL - 1 or CL - 2 as per the CL values programmed in the MR0 register.

### 2.3.3.5 Write leveling

For better signal integrity, DDR3 memory module adopted fly-by topology for the commands, addresses, control signals, and clocks. The fly-by topology has the benefit of reducing the number of stubs and their length, but it also causes flight time skew between clock and strobe at every DRAM on the DIMM. This makes it difficult for the Controller to maintain tDQSS, tDSS, and tDSH specification. Therefore, the DDR3 SDRAM supports a ‘write leveling’ feature to allow the controller to compensate for skew.

### 2.3.3.6 Output Disable

The DDR3 SDRAM outputs may be enabled/disabled by MR1 (bit A12) as shown in Figure 2.3.3. When this feature is enabled (A12 = 1), all output pins (DQs, DQS, DQS#, etc.) are disconnected from the device, thus removing any loading of the output drivers. This feature may be useful when measuring module power, for example. For normal operation, A12 should be set to ‘0’.

### 2.3.3.7 TDQS, TDQS#

TDQS (Termination Data Strobe) is a feature of X8 DDR3 SDRAM that provides additional termination resistance outputs that may be useful in some system configurations. The TDQS function is available in X8 DDR3 SDRAM only and must be disabled via the mode register A11=0 in MR1 for X16 configuration.

## 2.3.4 Mode Register MR2



The Mode Register MR2 stores the data for controlling refresh related features, Rtt\_WR impedance, and CAS write latency. The Mode Register 2 is written by asserting low on CS#, RAS#, CAS#, WE#, high on BA1 and low on BA0 and BA2, while controlling the states of address pins according to the below.

|     |     |     |         |     |     |        |    |     |     |     |     |    |    |      |    |    |                 |
|-----|-----|-----|---------|-----|-----|--------|----|-----|-----|-----|-----|----|----|------|----|----|-----------------|
| BA2 | BA1 | BA0 | A14-A13 | A12 | A11 | A10    | A9 | A8  | A7  | A6  | A5  | A4 | A3 | A2   | A1 | A0 | Address Field   |
| 0   | 1   | 0   | 0*1     |     |     | Rtt_WR |    | 0*1 | SRT | ASR | CWL |    |    | PASR |    |    | Mode Register 2 |

|    |                                      |
|----|--------------------------------------|
| A7 | Self-Refresh Temperature (SRT) Range |
| 0  | Normal operating temperature range   |
| 1  | Extended operating temperature range |

|    |    |    |  |
|----|----|----|--|
| A2 | A1 | A0 | Partial Array Self-Refresh (Optional)            |
| 0  | 0  | 0  | Full Array                                       |
| 0  | 0  | 1  | HalfArray (BA[2:0]=000,001,010, & 011)           |
| 0  | 1  | 0  | Quarter Array (BA[2:0]=000, & 001)               |
| 0  | 1  | 1  | 1/8th Array (BA[2:0] = 000)                      |
| 1  | 0  | 0  | 3/4 Array (BA[2:0] = 010,011,100,101,110, & 111) |
| 1  | 0  | 1  | HalfArray (BA[2:0] = 100, 101, 110, &111)        |
| 1  | 1  | 0  | Quarter Array (BA[2:0]=110, &111)                |
| 1  | 1  | 1  | 1/8th Array (BA[2:0]=111)                        |

|    |                           |
|----|---------------------------|
| A6 | Auto Self-Refresh (ASR)   |
| 0  | Manual SR Reference (SRT) |
| 1  | ASR enable                |

|     |    |   |
|-----|----|---|
| A10 | A9 | Rtt_WR *2   |
| 0   | 0  | Dynamic ODT off (Write does not affect Rtt value) |
| 0   | 1  | RZQ/4   |
| 1   | 0  | RZQ/2   |
| 1   | 1  | Reserved  |

|    |    |    |                                    |
|----|----|----|------------------------------------|
| A5 | A4 | A3 | CAS write Latency (CWL)            |
| 0  | 0  | 0  | 5 (tCK(avg) ≥ 2.5 ns)              |
| 0  | 0  | 1  | 6 (2.5 ns > tCK(avg) ≥ 1.875 ns)   |
| 0  | 1  | 0  | 7 (1.875 ns > tCK(avg) ≥ 1.5 ns)   |
| 0  | 1  | 1  | 8 (1.5 ns > tCK(avg) ≥ 1.25 ns)    |
| 1  | 0  | 0  | 9 (1.25 ns > tCK(avg) ≥ 1.07ns)    |
| 1  | 0  | 1  | 10 (1.07 ns > tCK(avg) ≥ 0.935 ns) |
| 1  | 1  | 0  | Reserved                           |
| 1  | 1  | 1  | Reserved                           |

|     |     |           |
|-----|-----|-----------|
| BA1 | BA0 | MR Select |
| 0   | 0   | MR0       |
| 0   | 1   | MR1       |
| 1   | 0   | MR2       |
| 1   | 1   | MR3       |

\* 1 : A5, A8, A11 ~ A14 must be programmed to 0 during MRS.

\* 2 : The Rtt\_WR value can be applied during writes even when Rtt\_Nom is disabled. During write leveling, Dynamic ODT is not available.

Figure 2.3.4 MR2 Definition

### 2.3.4.1 Partial Array Self-Refresh (PASR)

If PASR (Partial Array Self-Refresh) is enabled, data located in areas of the array beyond the specified address range shown in Figure 2.3.4 will be lost if Self-Refresh is entered. Data integrity will be maintained if tREFI conditions are met and no Self-Refresh command is issued.

### 2.3.4.2 CAS Write Latency (CWL)

The CAS Write Latency is defined by MR2 (bits A3-A5), as shown in Figure 2.3.4. CAS Write Latency is the delay, in clock cycles, between the internal Write command and the availability of the first bit of input data. DDR3 SDRAM does not support any half-clock latencies. The overall Write Latency (WL) is defined as Additive Latency (AL) + CAS Write Latency (CWL); WL = AL + CWL. For more information on the supported CWL and AL settings based on the operating clock frequency, refer to “Standard Speed Bins”.

### 2.3.4.3 Auto Self-Refresh (ASR) and Self-Refresh Temperature (SRT)

For more details refer to “Extended Temperature Usage”. DDR3 SDRAMs support Self-Refresh operation at all supported temperatures. Applications requiring Self-Refresh operation in the Extended Temperature Range must use the ASR function or program the SRT bit appropriately.

### 2.3.4.4 Dynamic ODT (Rtt\_WR)

DDR3 SDRAM introduces a new feature “Dynamic ODT”. In certain application cases and to further enhance signal integrity on the data bus, it is desirable that the termination strength of the DDR3 SDRAM can be changed without issuing an MRS command. MR2 Register locations A9 and A10 configure the Dynamic ODT settings. In Write leveling mode, only RTT\_Nom is available. For details on Dynamic ODT operation, refer to “Dynamic ODT”.

### 2.3.5 Mode Register MR3

The Mode Register MR3 controls Multi-purpose registers. The Mode Register 3 is written by asserting low on CS#, RAS#, CAS#, WE#, high on BA1 and BA0, and low on BA2 while controlling the states of address pins according to the below.

|     |     |     |         |     |     |     |    |    |    |    |    |    |    |     |         |                 |               |
|-----|-----|-----|---------|-----|-----|-----|----|----|----|----|----|----|----|-----|---------|-----------------|---------------|
| BA2 | BA1 | BA0 | A14-A13 | A12 | A11 | A10 | A9 | A8 | A7 | A6 | A5 | A4 | A3 | A2  | A1      | A0              | Address Field |
| 0   | 1   | 1   | 0*1     |     |     |     |    |    |    |    |    |    |    | MPR | MPR Loc | Mode Register 3 |               |

MRP Operation

| A2 | MPR                 |
|----|---------------------|
| 0  | Normal operation *3 |
| 1  | Dataflow from MPR   |

MPR Address

| A1 | A0 | MPR location          |
|----|----|-----------------------|
| 0  | 0  | Predefined pattern *2 |
| 0  | 1  | RFU                   |
| 1  | 0  | RFU                   |
| 1  | 1  | RFU                   |

| BA1 | BA0 | MR Select |
|-----|-----|-----------|
| 0   | 0   | MR0       |
| 0   | 1   | MR1       |
| 1   | 0   | MR2       |
| 1   | 1   | MR3       |

\* 1 : A3 - A14 must be programmed to 0 during MRS.

\* 2 : The predefined pattern will be used for read synchronization.

\* 3 : When MPR control is set for normal operation (MR3 A[2] = 0) then MR3 A[1:0] will be ignored.

Figure 2.3.5 MR3 Definition

#### 2.3.5.1 Multi-Purpose Register (MPR)

The Multi Purpose Register (MPR) function is used to Read out a predefined system timing calibration bit sequence. To enable the MPR, a Mode Register Set (MRS) command must be issued to MR3 register with bit A2=1. Prior to issuing the MRS command, all banks must be in the idle state (all banks precharged and tRP met). Once the MPR is enabled, any subsequent RD or RDA commands will be redirected to the Multi Purpose Register. When the MPR is enabled, only RD or RDA commands are allowed until a subsequent MRS command is issued with the MPR disabled (MR3 bit A2=0). Power down mode, Self-Refresh and any other non-RD/RDA command is not allowed during MPR enable mode. The RESET function is supported during MPR enable mode.

The Multi Purpose Register (MPR) function is used to Read out a predefined system timing calibration bit sequence. The basic concept of the MPR is shown in Figure 2.3.5.1.





Figure 2.3.5.1 MPR Block Diagram

To enable the MPR, a MODE Register Set (MRS) command must be issued to MR3 Register with bit A2 = 1. Prior to issuing the MRS command, all banks must be in the idle state (all banks precharged and tRP met). Once the MPR is enabled, any subsequent RD or RDA commands will be redirected to the Multi Purpose Register.

The resulting operation, when a RD or RDA command is issued, is defined by MR3 bits A[1:0] when the MPR is enabled. When the MPR is enabled, only RD or RDA commands are allowed until a subsequent MRS command is issued with the MPR disabled (MR3 bit A2 = 0).

Note that in MPR mode RDA has the same functionality as a READ command which means the auto precharge part of RDA is ignored. Power-Down mode, Self-Refresh and any other non-RD/RDA command is not allowed during MPR enable mode. The RESET function is supported during MPR enable mode.

#### MPR MR3 Register Definition

| MR3 A[2] | MR3 A[1:0]               | Function  |
|----------|--------------------------|---|
| MPR      | MPR-Loc                  |   |
| 0b       | don't care (0b or 1b)    | Normal operation, no MPR transaction. All subsequent Reads will come from DRAM array. All subsequent Write will go to DRAM array. |
| 1b       | See MPR Definition table | Enable MPR mode, subsequent RD/RDA commands defined by MR3 A[1:0].  |

**MPR Register Address Definition**

The following Table provides an overview of the available data locations, how they are addressed by MR3 A[1:0] during a MRS to MR3, and how their individual bits are mapped into the burst order bits during a Multi Purpose Register Read.

**MPR MR3 Register Definition**

| MR3 A[2] | MR3 A[1:0] | Function                                       | Burst Length | Read Address A[2:0] | Burst Order and Data Pattern  |
|----------|------------|--|--------------|---------------------|---|
| 1b       | 00b        | Read predefined pattern for system Calibration | BL8          | 000b                | Burst order 0,1,2,3,4,5,6,7<br>Pre-defined Data Pattern [0,1,0,1,0,1,0,1] |
|          |            |  | BC4          | 000b                | Burst order 0,1,2,3<br>Pre-defined Data Pattern [0,1,0,1]                 |
|          |            |  | BC4          | 100b                | Burst order 4,5,6,7<br>Pre-defined Data Pattern [0,1,0,1]                 |
| 1b       | 01b        | RFU  | BL8          | 000b                | Burst order 0,1,2,3,4,5,6,7   |
|          |            |  | BC4          | 000b                | Burst order 0,1,2,3   |
|          |            |  | BC4          | 100b                | Burst order 4,5,6,7   |
| 1b       | 10b        | RFU  | BL8          | 000b                | Burst order 0,1,2,3,4,5,6,7   |
|          |            |  | BC4          | 000b                | Burst order 0,1,2,3   |
|          |            |  | BC4          | 100b                | Burst order 4,5,6,7   |
| 1b       | 11b        | RFU  | BL8          | 000b                | Burst order 0,1,2,3,4,5,6,7   |
|          |            |  | BC4          | 000b                | Burst order 0,1,2,3   |
|          |            |  | BC4          | 100b                | Burst order 4,5,6,7   |

NOTE: Burst order bit 0 is assigned to LSB and the burst order bit 7 is assigned to MSB of the selected MPR agent

**MPR Functional Description**

- One bit wide logical interface via all DQ pins during READ operation.
- Register Read on x16:
  - DQL[0] and DQU[0] drive information from MPR.
  - DQL[7:1] and DQU[7:1] either drive the same information as DQL[0], or they drive 0b.
- Addressing during for Multi Purpose Register reads for all MPR agents:
  - BA[2:0]: don't care
  - A[1:0]: A[1:0] must be equal to '00'b. Data read burst order in nibble is fixed
  - A[2]: For BL=8, A[2] must be equal to 0b, burst order is fixed to [0,1,2,3,4,5,6,7], \*) For Burst Chop 4 cases, the burst order is switched on nibble base A[2]=0b, Burst order: 0,1,2,3 \*) A[2]=1b, Burst order: 4,5,6,7 \*)
  - A[9:3]: don't care
  - A10/AP: don't care
  - A12/BC: Selects burst chop mode on-the-fly, if enabled within MR0.
  - A11, A13, A14: don't care
- Regular interface functionality during register reads:
  - Support two Burst Ordering which are switched with A2 and A[1:0]=00b.
  - Support of read burst chop (MRS and on-the-fly via A12/BC)
  - All other address bits (remaining column address bits including A10, all bank address bits) will be ignored by the DDR3 SDRAM.
  - Regular read latencies and AC timings apply.
  - DLL must be locked prior to MPR Reads.

NOTE: \*) Burst order bit 0 is assigned to LSB and burst order bit 7 is assigned to MSB of the selected MPR agent.

NOTE: Good reference for the example of MPR feature is the JEDEC standard No.93-3D, 4.10.4 Protocol example.

**Relevant Timing Parameters**

AC timing parameters are important for operating the Multi Purpose Register: tRP, tMRD, tMOD, and tMPRR. For more details refer to "Electrical Characteristics & AC Timing"

## 2.4 DDR3 SDRAM Command Description and Operation

### 2.4.1 Command Truth Table

[BA=Bank Address, RA=Row Address, CA=Column Address, BC#=Burst Chop, X=Don't Care, V=Valid]

| Function                                     | Abbreviation | CKE            |               | CS# | RAS# | CAS# | WE# | BA0-BA2 | A11, A13, A14   | A12/BC# | A10/AP | A0-A9 | Notes    |
|--|--------------|----------------|---------------|-----|------|------|-----|---------|-----------------|---------|--------|-------|----------|
|  |              | Previous Cycle | Current Cycle |     |      |      |     |         |                 |         |        |       |          |
| Mode Register Set                            | MRS          | H              | H             | L   | L    | L    | L   | BA      | OP Code         |         |        |       |          |
| Refresh                                      | REF          | H              | H             | L   | L    | L    | H   | V       | V               | V       | V      | V     |          |
| Self Refresh Entry                           | SRE          | H              | L             | L   | L    | L    | H   | V       | V               | V       | V      | V     | 7,9,12   |
| Self Refresh Exit                            | SRX          | L              | H             | H   | X    | X    | X   | X       | X               | X       | X      | X     | 7,8,9,12 |
|  |              |                |               | L   | H    | H    | H   | V       | V               | V       | V      | V     |          |
| Single Bank Precharge                        | PRE          | H              | H             | L   | L    | H    | L   | BA      | V               | V       | L      | V     |          |
| Precharge all Banks                          | PREA         | H              | H             | L   | L    | H    | L   | V       | V               | V       | H      | V     |          |
| Bank Activate                                | ACT          | H              | H             | L   | L    | H    | H   | BA      | Row Address(RA) |         |        |       |          |
| Write (Fixed BL8 or BC4)                     | WR           | H              | H             | L   | H    | L    | L   | BA      | RFU             | V       | L      | CA    |          |
| Write (BC4, on the Fly)                      | WRS4         | H              | H             | L   | H    | L    | L   | BA      | RFU             | L       | L      | CA    |          |
| Write (BL8, on the Fly)                      | WRS8         | H              | H             | L   | H    | L    | L   | BA      | RFU             | H       | L      | CA    |          |
| Write with Auto Precharge (Fixed BL8 or BC4) | WRA          | H              | H             | L   | H    | L    | L   | BA      | RFU             | V       | H      | CA    |          |
| Write with Auto Precharge (BC4, on the Fly)  | WRAS4        | H              | H             | L   | H    | L    | L   | BA      | RFU             | L       | H      | CA    |          |
| Write with Auto Precharge (BL8, on the Fly)  | WRAS8        | H              | H             | L   | H    | L    | L   | BA      | RFU             | H       | H      | CA    |          |
| Read (Fixed BL8 or BC4)                      | RD           | H              | H             | L   | H    | L    | H   | BA      | RFU             | V       | L      | CA    |          |
| Read (BC4, on the Fly)                       | RDS4         | H              | H             | L   | H    | L    | H   | BA      | RFU             | L       | L      | CA    |          |
| Read (BL8, on the Fly)                       | RDS8         | H              | H             | L   | H    | L    | H   | BA      | RFU             | H       | L      | CA    |          |
| Read with Auto Precharge (Fixed BL8 or BC4)  | RDA          | H              | H             | L   | H    | L    | H   | BA      | RFU             | V       | H      | CA    |          |
| Read with Auto Precharge (BC4, on the Fly)   | RDAS4        | H              | H             | L   | H    | L    | H   | BA      | RFU             | L       | H      | CA    |          |
| Read with Auto Precharge (BL8, on the Fly)   | RDAS8        | H              | H             | L   | H    | L    | H   | BA      | RFU             | H       | H      | CA    |          |
| No Operation                                 | NOP          | H              | H             | L   | H    | H    | H   | V       | V               | V       | V      | V     | 10       |
| Device Deselected                            | DES          | H              | H             | H   | X    | X    | X   | X       | X               | X       | X      | X     | 11       |
| Power Down Entry                             | PDE          | H              | L             | L   | H    | H    | H   | V       | V               | V       | V      | V     | 6,12     |
|  |              |                |               | H   | X    | X    | X   | X       | X               | X       | X      | X     |          |
| Power Down Exit                              | PDX          | L              | H             | L   | H    | H    | H   | V       | V               | V       | V      | V     | 6,12     |
|  |              |                |               | H   | X    | X    | X   | X       | X               | X       | X      | X     |          |
| ZQ Calibration Long                          | ZQCL         | H              | H             | L   | H    | H    | L   | X       | X               | X       | H      | X     |          |
| ZQ Calibration Short                         | ZQCS         | H              | H             | L   | H    | H    | L   | X       | X               | X       | L      | X     |          |

Notes:

- All DDR3 SDRAM commands are defined by states of CS#, RAS#, CAS#, WE# and CKE at the rising edge of the clock. The MSB of BA, RA and CA are device density and configuration dependant.
- RESET# is Low enable command which will be used only for asynchronous reset so must be maintained HIGH during any function.
- Bank addresses (BA) determine which bank is to be operated upon. For (E)MRS BA selects an (Extended) Mode Register.
- "V" means "H or L (but a defined logic level)" and "X" means either "defined or undefined (like floating) logic level".
- Burst reads or writes cannot be terminated or interrupted and Fixed/on-the-Fly BL will be defined by MRS.
- The Power Down Mode does not perform any refresh operation.
- The state of ODT does not affect the states described in this table. The ODT function is not available during Self Refresh.
- Self Refresh Exit is asynchronous.
- VREF(Both VrefDQ and VrefCA) must be maintained during Self Refresh operation. VrefDQ supply may be turned OFF and VREFDQ may take any value between VSS and VDD during Self Refresh operation, provided that VrefDQ is valid and stable prior to CKE going back High and that first Write operation or first Write Leveling Activity may not occur earlier than 512 nCK after exit from Self Refresh.
- The No Operation command should be used in cases when the DDR3 SDRAM is in an idle or wait state. The purpose of the No Operation command (NOP) is to prevent the DDR3 SDRAM from registering any unwanted commands between operations. A No Operation command will not terminate a pervious operation that is still executing, such as a burst read or write cycle.
- The Deselect command performs the same function as No Operation command.
- Refer to the CKE Truth Table for more detail with CKE transition.

### 2.4.1. CKE Truth Table

| Current State <sup>2</sup> | CKE                               |                                | Command (N) <sup>3</sup><br>RAS#, CAS#,<br>WE#, CS# | Action (N) <sup>3</sup>    | Notes       |
|----------------------------|-----------------------------------|--------------------------------|---|----------------------------|-------------|
|                            | Previous Cycle <sup>1</sup> (N-1) | Current Cycle <sup>1</sup> (N) |   |                            |             |
| Power-Down                 | L                                 | L                              | X   | Maintain Power-Down        | 14,15       |
|                            | L                                 | H                              | DESELECT or NOP                                     | Power-Down Exit            | 11,14       |
| Self-Refresh               | L                                 | L                              | X   | Maintain Self-Refresh      | 15,16       |
|                            | L                                 | H                              | DESELECT or NOP                                     | Self-Refresh Exit          | 8,12,16     |
| Bank(s) Active             | H                                 | L                              | DESELECT or NOP                                     | Active Power-Down Entry    | 11,13,14    |
| Reading                    | H                                 | L                              | DESELECT or NOP                                     | Power-Down Entry           | 11,13,14,17 |
| Writing                    | H                                 | L                              | DESELECT or NOP                                     | Power-Down Entry           | 11,13,14,17 |
| Precharging                | H                                 | L                              | DESELECT or NOP                                     | Power-Down Entry           | 11,13,14,17 |
| Refreshing                 | H                                 | L                              | DESELECT or NOP                                     | Precharge Power-Down Entry | 11          |
| All Bank Idle              | H                                 | L                              | DESELECT or NOP                                     | Precharge Power-Down Entry | 11,13,14,18 |
|                            | H                                 | L                              | REFRESH   | Self-Refresh               | 9.13.18     |

- Notes:
1. CKE (N) is the logic state of CKE at clock edge N; CKE (N-1) was the state of CKE at the previous clock edge.
  2. Current state is defined as the state of the DDR3 SDRAM immediately prior to clock edge N.
  3. COMMAND (N) is the command registered at clock edge N, and ACTION (N) is a result of COMMAND (N), ODT is not included here.
  4. All states and sequences not shown are illegal or reserved unless explicitly described elsewhere in this document.
  5. The state of ODT does not affect the states described in this table. The ODT function is not available during Self-Refresh.
  6. CKE must be registered with the same value on tCKEmin consecutive positive clock edges. CKE must remain at the valid input level the entire time it takes to achieve the tCKEmin clocks of registration. Thus, after any CKE transition, CKE may not transition from its valid level during the time period of tIS + tCKEmin + tIH.
  7. DESELECT and NOP are defined in the Command Truth Table.
  8. On Self-Refresh Exit DESELECT or NOP commands must be issued on every clock edge occurring during the tXS period. Read or ODT commands may be issued only after tXSDLL is satisfied.
  9. Self-Refresh mode can only be entered from the All Banks Idle state.
  10. Must be a legal command as defined in the Command Truth Table.
  11. Valid commands for Power-Down Entry and Exit are NOP and DESELECT only.
  12. Valid commands for Self-Refresh Exit are NOP and DESELECT only.
  13. Self-Refresh cannot be entered during Read or Write operations.
  14. The Power-Down does not perform any refresh operations.
  15. "X" means "don't care" (including floating around VREF) in Self-Refresh and Power-Down. It also applies to Address pins.
  16. VREF (Both Vref\_DQ and Vref\_CA) must be maintained during Self-Refresh operation. VrefDQ supply may be turned OFF and VREFDQ may take any value between VSS and VDD during Self Refresh operation, provided that VrefDQ is valid and stable prior to CKE going back High and that first Write operation or first Write Leveling Activity may not occur earlier than 512 nCK after exit from Self Refresh.
  17. If all banks are closed at the conclusion of the read, write or precharge command, then Precharge Power-Down is entered, otherwise Active Power-Down is entered.
  18. 'Idle state' is defined as all banks are closed (tRP, tDAL, etc. satisfied), no data bursts are in progress, CKE is high, and all timings from previous operations are satisfied (tMRD, tMOD, tRFC, tZQinit, tZQoper, tZQCS, etc.) as well as all Self-Refresh exit and Power-Down Exit parameters are satisfied (tXS, tXP, tXPDLL, etc).

### 2.4.2 No Operation (NOP) Command

The No operation (NOP) command is used to instruct the selected DDR3 SDRAM to perform a NOP ( CS# low and RAS#,CAS#,WE# high). This prevents unwanted commands from being registered during idle or wait states. Operations already in progress are not affected.

### 2.4.3 Deselect(DES) Command

The Deselect function (CS# HIGH) prevents new commands from being executed by the DDR3 SDRAM. The DDR3 SDRAM is effectively deselected. Operations already in progress are not affected.

### 2.4.4 DLL-off Mode

DDR3 DLL-off mode is entered by setting MR1 bit A0 to “1”; this will disable the DLL for subsequent operations until A0 bit set back to “0”. The MR1 A0 bit for DLL control can be switched either during initialization or later. The DLL-off Mode operations listed below are an optional feature for DDR3. The maximum clock frequency for DLL-off Mode is specified by the parameter tCKDLL\_OFF. There is no minimum frequency limit besides the need to satisfy the refresh interval, tREFI. Due to latency counter and timing restrictions, only one value of CAS Latency (CL) in MR0 and CAS Write Latency (CWL) in MR2 are supported. The DLL-off mode is only required to support setting of both CL=6 and CWL=6. DLL-off mode will affect the Read data Clock to Data Strobe relationship (tDQSCK) but not the data Strobe to Data relationship (tDQSQ, tQH). Special attention is needed to line up Read data to controller time domain.

Comparing with DLL-on mode, where tDQSCK starts from the rising clock edge (AL+CL) cycles after the Read command, the DLL-off mode tDQSCK starts (AL+CL-1) cycles after the read command. Another difference is that tDQSCK may not be small compared to tCK (it might even be larger than tCK) and the difference between tDQSCKmin and tDQSCKmax is significantly larger than in DLL-on mode. The timing relations on DLL-off mode READ operation have shown at the following Timing Diagram (CL=6, BL=8)



Note: The tDQSCK is used here for DQS, DQS#, and DQ to have a simplified diagram; the DLL\_off shift will affect both timings in the same way and the skew between all DQ, DQS, and DQS# signals will still be tDQSQ.

Figure 2.4.4 DLL-off mode READ Timing Operation

#### **2.4.5 DLL on/off switching procedure**

DDR3 DLL-off mode is entered by setting MR1 bit A0 to “1”; this will disable the DLL for subsequent operation until A0 bit set back to “0”.

##### **2.4.5.1 DLL “on” to DLL “off” Procedure**

To switch from DLL “on” to DLL “off” requires the frequency to be changed during Self-Refresh outlined in the following procedure:

1. Starting from Idle state (all banks pre-charged, all timing fulfilled, and DRAMs On-die Termination resistors, RTT, must be in high impedance state before MRS to MR1 to disable the DLL).
2. Set MR1 Bit A0 to “1” to disable the DLL.
3. Wait tMOD.
4. Enter Self Refresh Mode; wait until (tCKSRE) satisfied.
5. Change frequency, in guidance with “Input Clock Frequency Change” section.
6. Wait until a stable clock is available for at least (tCKSRX) at DRAM inputs.
7. Starting with the Self Refresh Exit command, CKE must continuously be registered HIGH until all tMOD timings from any MRS command are satisfied. In addition, if any ODT features were enabled in the mode registers when Self Refresh mode was entered, the ODT signal must continuously be registered LOW until all tMOD timings from any MRS command are satisfied. If both ODT features were disabled in the mode registers when Self Refresh mode was entered, ODT signal can be registered LOW or HIGH.
8. Wait tXS, and then set Mode Registers with appropriate values (especially an update of CL, CWL, and WR may be necessary. A ZQCL command may also be issued after tXS).
9. Wait for tMOD, and then DRAM is ready for next command.

##### **2.4.5.2 DLL “off” to DLL “on” Procedure**

To switch from DLL “off” to DLL “on” (with required frequency change) during Self-Refresh:

1. Starting from Idle state (All banks pre-charged, all timings fulfilled and DRAMs On-die Termination resistors (RTT) must be in high impedance state before Self-Refresh mode is entered.)
2. Enter Self Refresh Mode, wait until tCKSRE satisfied.
3. Change frequency, in guidance with "Input clock frequency change".
4. Wait until a stable clock is available for at least (tCKSRX) at DRAM inputs.
5. Starting with the Self Refresh Exit command, CKE must continuously be registered HIGH until tDLLK timing from subsequent DLL Reset command is satisfied. In addition, if any ODT features were enabled in the mode registers when Self Refresh mode was entered, the ODT signal must continuously be registered LOW until tDLLK timings from subsequent DLL Reset command is satisfied. If both ODT features are disabled in the mode registers when Self Refresh mode was entered, ODT signal can be registered LOW or HIGH.
6. Wait tXS, then set MR1 bit A0 to “0” to enable the DLL.
7. Wait tMRD, then set MR0 bit A8 to “1” to start DLL Reset.
8. Wait tMRD, then set Mode Registers with appropriate values (especially an update of CL, CWL and WR may be necessary. After tMOD satisfied from any proceeding MRS command, a ZQCL command may also be issued during or after tDLLK.)
9. Wait for tMOD, then DRAM is ready for next command (Remember to wait tDLLK after DLL Reset before applying command requiring a locked DLL!). In addition, wait also for tZQoper in case a ZQCL command was issued.



#### **2.4.6. Input clock frequency change**

Once the DDR3 SDRAM is initialized, the DDR3 SDRAM requires the clock to be “stable” during almost all states of normal operation. This means that, once the clock frequency has been set and is to be in the “stable state”, the clock period is not allowed to deviate except for what is allowed for by the clock jitter and SSC (spread spectrum clocking) specifications.

The input clock frequency can be changed from one stable clock rate to another stable clock rate under two conditions: (1) Self-Refresh mode and (2) Precharge Power-down mode. Outside of these two modes, it is illegal to change the clock frequency.

For the first condition, once the DDR3 SDRAM has been successfully placed in to Self-Refresh mode and tCKSRE has been satisfied, the state of the clock becomes a don't care. Once a don't care, changing the clock frequency is permissible, provided the new clock frequency is stable prior to tCKSRX. When entering and exiting Self-Refresh mode for the sole purpose of changing the clock frequency, the Self-Refresh entry and exit specifications must still be met.

The DDR3 SDRAM input clock frequency is allowed to change only within the minimum and maximum operating frequency specified for the particular speed grade. Any frequency change below the minimum operating frequency would require the use of DLL\_on- mode -> DLL\_off -mode transition sequence, refer to “DLL on/off switching procedure”.

The second condition is when the DDR3 SDRAM is in Precharge Power-down mode (either fast exit mode or slow exit mode). If the RTT\_NOM feature was enabled in the mode register prior to entering Precharge power down mode, the ODT signal must continuously be registered LOW ensuring RTT is in an off state. If the RTT\_NOM feature was disabled in the mode register prior to entering Precharge power down mode, RTT will remain in the off state. The ODT signal can be registered either LOW or HIGH in this case. A minimum of tCKSRE must occur after CKE goes LOW before the clock frequency may change. The DDR3 SDRAM input clock frequency is allowed to change only within the minimum and maximum operating frequency specified for the particular speed grade. During the input clock frequency change, ODT and CKE must be held at stable LOW levels. Once the input clock frequency is changed, stable new clocks must be provided to the DRAM tCKSRX before Precharge Power-down may be exited; after Precharge Power-down is exited and tXP has expired, the DLL must be RESET via MRS. Depending on the new clock frequency, additional MRS commands may need to be issued to appropriately set the WR, CL, and CWL with CKE continuously registered high. During DLL re-lock period, ODT must remain LOW and CKE must remain HIGH. After the DLL lock time, the DRAM is ready to operate with new clock frequency.

#### **2.4.7 Write leveling**

For better signal integrity, the DDR3 memory module adopted fly-by topology for the commands, addresses, control signals, and clocks. The fly-by topology has benefits from reducing number of stubs and their length, but it also causes flight time skew between clock and strobe at every DRAM on the DIMM. This makes it difficult for the Controller to maintain tDQSS, tDSS, and tDSH specification. Therefore, the DDR3 SDRAM supports a ‘write leveling’ feature to allow the controller to compensate for skew.

The memory controller can use the ‘write leveling’ feature and feedback from the DDR3 SDRAM to adjust the DQS - DQS# to CK - CK# relationship. The memory controller involved in the leveling must have adjustable delay setting on DQS - DQS# to align the rising edge of DQS - DQS# with that of the clock at the DRAM pin. The DRAM asynchronously feeds back CK - CK#, sampled with the rising edge of DQS - DQS#, through the DQ bus. The controller repeatedly delays DQS - DQS# until a transition from 0 to 1 is detected. The DQS - DQS# delay established through this exercise would ensure tDQSS specification.

Besides tDQSS, tDSS and tDSH specification also needs to be fulfilled. One way to achieve this is to combine the actual tDQSS in the application with an appropriate duty cycle and jitter on the DQS - DQS# signals. Depending on the actual tDQSS in the application, the actual values for tDQSL and tDQSH may have to be better than the absolute limits provided in the chapter "AC Timing Parameters" in order to satisfy tDSS and tDSH specification. A conceptual timing of this scheme is shown in Figure 2.4.7.



Figure 2.4.7 Write Leveling Concept

DQS - DQS# driven by the controller during leveling mode must be terminated by the DRAM based on ranks populated. Similarly, the DQ bus driven by the DRAM must also be terminated at the controller.

One or more data bits carry the leveling feedback to the controller across the DRAM configurations X8 and X16. On a X16 device, both byte lanes should be leveled independently.

Therefore, a separate feedback mechanism should be available for each byte lane. The upper data bits should provide the feedback of the upper diff\_DQS(diff\_UDQS) to clock relationship whereas the lower data bits would indicate the lower diff\_DQS(diff\_LDQS) to clock relationship.

### 2.4.7.1 DRAM setting for write leveling & DRAM termination function in that mode

DRAM enters into Write leveling mode if A7 in MR1 set 'High' and after finishing leveling, DRAM exits from write leveling mode if A7 in MR1 set 'Low'. Note that in write leveling mode, only DQS/DQS# terminations are activated and deactivated via ODT pin, unlike normal operation.

#### MR setting involved in the leveling procedure

| Function                  | MR1 | Enable | Disable |
|---------------------------|-----|--------|---------|
| Write leveling enable     | A7  | 1      | 0       |
| Output buffer mode (Qoff) | A12 | 0      | 1       |

#### DRAM termination function in the leveling mode

| ODT pin @DRAM | DQS/DQS# termination | DQs termination |
|---------------|----------------------|-----------------|
| De-asserted   | Off                  | Off             |
| Asserted      | On                   | Off             |

NOTE: In Write Leveling Mode with its output buffer disabled (MR1[bit7] = 1 with MR1[bit12] = 1) all RTT\_Nom settings are allowed; in Write Leveling Mode with its output buffer enabled (MR1[bit7] = 1 with MR1[bit12] = 0) only RTT\_Nom settings of RZQ/2, RZQ/4 and RZQ/6 are allowed.



### 2.4.7.2 Procedure Description

The Memory controller initiates Leveling mode of all DRAMs by setting bit 7 of MR1 to 1. When entering write leveling mode, the DQ pins are in undefined driving mode. During write leveling mode, only NOP or DESELECT commands are allowed, as well as an MRS command to exit write leveling mode. Since the controller levels one rank at a time, the output of other ranks must be disabled by setting MR1 bit A12 to 1.

The Controller may assert ODT after tMOD, at which time the DRAM is ready to accept the ODT signal.

The Controller may drive DQS low and DQS# high after a delay of tWLDQSEN, at which time the DRAM has applied on-die termination on these signals. After tDQSL and tWLMRD, the controller provides a single DQS, DQS# edge which is used by the DRAM to sample CK - CK# driven from controller. tWLMRD(max) timing is controller dependent.

DRAM samples CK - CK# status with rising edge of DQS - DQS# and provides feedback on the DQ bus asynchronously after tWLO timing. In this product, the DQ0 for x8, or DQ0 and DQ8 for x16 ("prime DQ bit(s)") provide the leveling feedback. The DRAM's remaining DQ bits are driven Low statically after the first sampling procedure. There is a DQ output uncertainty of tWLOE defined to allow mismatch on DQ bits. The tWLOE period is defined from the transition of the earliest DQ bit to the corresponding transition of the latest DQ bit. There are no read strobes (DQS/DQS#) needed for these DQs. Controller samples incoming DQ and decides to increment or decrement DQS - DQS# delay setting and launches the next DQS/DQS# pulse after some time, which is controller dependent. Once a 0 to 1 transition is detected, the controller locks DQS - DQS# delay setting and write leveling is achieved for the device. Figure 2.4.7.2 describes the timing diagram and parameters for the overall Write Leveling procedure.



**Figure 2.4.7.2 Write leveling sequence [DQS - DQS# is capturing CK-CK# low at T1 and CK-CK# high at T2]**

- Notes:
1. The JEDEC specification for DDR3 DRAM has the option to drive leveling feedback on a single prime DQ or all DQs. For best compatibility with future DDR3 products, applications should use the lowest order DQ for each byte lane (DQ0 for x8, or DQ0 and DQ8 for x16).
  2. MRS: Load MR1 to enter write leveling mode.
  3. NOP: NOP or Deselect.
  4. diff\_DQS is the differential data strobe (DQS, DQS#). Timing reference points are the zero crossings. DQS is shown with solid line, DQS# is shown with dotted line.
  5. CK, CK# : CK is shown with solid dark line, where as CK# is drawn with dotted line.
  6. DQS, DQS# needs to fulfill minimum pulse width requirements tDQSH(min) and tDQSL(min) as defined for regular Writes; the max pulse width is system dependent.

### 2.4.7.3 Write Leveling Mode Exit

The following sequence describes how the Write Leveling Mode should be exited:

1. After the last rising strobe edge, stop driving the strobe signals. Note: From now on, DQ pins are in undefined driving mode, and will remain undefined, until tMOD after the respective MR command.
2. Drive ODT pin low (tIS must be satisfied) and continue registering low.
3. After the RTT is switched off, disable Write Level Mode via MRS command.
4. After tMOD is satisfied, any valid command may be registered. (MR commands may be issued after tMRD ).

### 2.4.8 Extended Temperature Usage

- a. Auto Self-refresh supported
- b. Extended Temperature Range supported
- c. Double refresh required for operation in the Extended Temperature Range (applies only for devices supporting the Extended Temperature Range)

#### Mode Register Description

| Field      | Bits     | Description  |
|------------|----------|--|
| <b>ASR</b> | MR2 (A6) | <b>Auto Self-Refresh (ASR)</b><br>when enabled, DDR3 SDRAM automatically provides Self-Refresh power management functions for all supported operating temperature values. If not enabled, the SRT bit must be programmed to indicate TOPER during subsequent Self-Refresh operation<br>0 = Manual SR Reference (SRT)<br>1 = ASR enable |
| <b>SRT</b> | MR2 (A7) | <b>Self-Refresh Temperature (SRT) Range</b><br>If ASR = 0, the SRT bit must be programmed to indicate TOPER during subsequent Self-Refresh operation<br>If ASR = 1, SRT bit must be set to 0b<br>0 = Normal operating temperature range<br>1 = Extended operating temperature range  |

#### 2.4.8.1 Auto Self-Refresh mode - ASR Mode

DDR3 SDRAM provides an Auto Self-Refresh mode (ASR) for application ease. ASR mode is enabled by setting MR2 bit A6 = 1b and MR2 bit A7 = 0b. The DRAM will manage Self-Refresh entry in either the Normal or Extended (optional) Temperature Ranges. In this mode, the DRAM will also manage Self-Refresh power consumption when the DRAM operating temperature changes, lower at low temperatures and higher at high temperatures.

If the ASR option is not supported by the DRAM, MR2 bit A6 must be set to 0b.

If the ASR mode is not enabled (MR2 bit.A6 = 0b), the SRT bit (MR2 A7) must be manually programmed with the operating temperature range required during Self-Refresh operation.

Support of the ASR option does not automatically imply support of the Extended Temperature Range. Refer to Operating Temperature Range for restrictions on operating conditions.

**2.4.8.2 Self-Refresh Temperature Range - SRT**

SRT applies to devices supporting Extended Temperature Range only. If ASR = 0b, the Self-Refresh Temperature (SRT) Range bit must be programmed to guarantee proper self-refresh operation. If SRT = 0b, then the DRAM will set an appropriate refresh rate for Self-Refresh operation in the Normal Temperature Range. If SRT = 1b then the DRAM will set an appropriate, potentially different, refresh rate to allow Self-Refresh operation in either the Normal or Extended Temperature Ranges. The value of the SRT bit can effect self-refresh power consumption, please refer to the IDD table for details.

For parts that do not support the Extended Temperature Range, MR2 bit A7 must be set to 0b and the DRAM should not be operated outside the Normal Temperature Range.

**Self-Refresh mode summary**

| <b>MR2 A[6]</b> | <b>MR2 A[7]</b> | <b>Self-Refresh operation</b>  | <b>Allowed Operating Temperature Range for Self-Refresh Mode</b> |
|-----------------|-----------------|--|--|
| 0               | 0               | Self-refresh rate appropriate for the Normal Temperature Range   | Normal (0 to 85 °C)  |
| 0               | 1               | Self-refresh rate appropriate for either the Normal or Extended Temperature Ranges. The DRAM must support Extended Temperature Range. The value of the SRT bit can affect self-refresh power consumption, please refer to the IDD table for details. | Normal (0 to 85 °C) and Extended (85 to 105 °C)                  |
| 1               | 0               | ASR enabled (for devices supporting ASR and Normal Temperature Range). Self-Refresh power consumption is temperature dependent   | Normal (0 to 85 °C)  |
| 1               | 0               | ASR enabled (for devices supporting ASR and Extended Temperature Range). Self-Refresh power consumption is temperature dependent   | Normal (0 to 85 °C) and Extended (85 to 105 °C)                  |
| 1               | 1               | Illegal  |  |

Note: Self-Refresh Mode operation above 95° C permitted only for Automotive grade (A2); refer to 3.2 Component Operating Temperature Range.

### 3. ABSOLUTE MAXIMUM RATINGS AND AC & DC OPERATING CONDITIONS

#### 3.1 Absolute Maximum DC Ratings.

| Symbol    | Parameter                           | Rating           | Units | Note |
|-----------|-------------------------------------|------------------|-------|------|
| VDD       | Voltage on VDD pin relative to Vss  | -0.4 V ~ 1.975 V | V     | 1,3  |
| VDDQ      | Voltage on VDDQ pin relative to Vss | -0.4 V ~ 1.975 V | V     | 1,3  |
| VIN, VOUT | Voltage on any pin relative to Vss  | -0.4 V ~ 1.975 V | V     | 1    |
| TSTG      | Storage Temperature                 | -55 to +150      | °C    | 1,2  |

Notes:

- Stresses greater than those listed under “Absolute Maximum Ratings” may cause permanent damage to the device. This is a stress rating only and functional operation of the device at these or any other conditions above those indicated in the operational sections of this specification is not implied. Exposure to absolute maximum rating conditions for extended periods may affect reliability.
- Storage Temperature is the case surface temperature on the center/top side of the DRAM.
- VDD and VDDQ must be within 300 mV of each other at all times; and VREF must be not greater than 0.6 x VDDQ, When VDD and VDDQ are less than 500 mV; VREF may be equal to or less than 300 mV

#### 3.2 Component Operating Temperature Range

| Symbol | Parameter       | Rating         | Units | Notes |
|--------|-----------------|----------------|-------|-------|
| TOPER  | Commercial      | Tc = 0 to 85   | °C    | 1,2   |
|        |                 | Tc = 85 to 95  | °C    | 1,3   |
|        | Industrial      | Tc = -40 to 85 | °C    | 1,2   |
|        |                 | Tc = 85 to 95  | °C    | 1,3   |
|        | Automotive (A1) | Tc = -40 to 85 | °C    | 1,2   |
|        |                 | Tc = 85 to 95  | °C    | 1,3   |
|        | Automotive (A2) | Tc = -40 to 85 | °C    | 1,2   |
|        |                 | Tc = 85 to 95  | °C    | 1,3   |
|        |                 | Tc = 95 to 105 | °C    | 1,3   |

Notes:

- Operating Temperature TOPER is the case surface temperature (Tc) on the center / top side of the DRAM.
- This temperature range specifies the temperatures where all DRAM specifications will be supported. During operation, the DRAM case temperature must be maintained in this range under all operating conditions.
- Some applications require operation of the DRAM in the Extended Temperature Range (85°C < Tc ≤ 105°C). For each permitted temperature range, full specifications are supported, but the following additional conditions apply:
  - Refresh commands must be doubled in frequency, therefore reducing the Refresh interval tREFI to 3.9 μs.
  - If Self-Refresh operation is required for this range, it is mandatory to use either the Manual Self-Refresh mode with Extended Temperature Range capability (MR2 A6 = 0b and MR2 A7 = 1b) or enable the Auto Self-Refresh mode (MR2 A6 = 1b and MR2 A7 = 0b).

#### 3.3 Recommended DC Operating Conditions

| Symbol | Parameter                 | Rating |       |      | Unit  | Notes |               |
|--------|---------------------------|--------|-------|------|-------|-------|---------------|
|        |                           | Min    | Typ   | Max  |       |       |               |
| VDD    | Supply Voltage            | DDR3   | 1.425 | 1.5  | 1.575 | V     | 1,2           |
|        |                           | DDR3L  | 1.283 | 1.35 | 1.45  | V     | 1,2,3,4,5,6,7 |
| VDDQ   | Supply Voltage for Output | DDR3   | 1.425 | 1.5  | 1.575 | V     | 1,2           |
|        |                           | DDR3L  | 1.283 | 1.35 | 1.45  | V     | 1,2,3,4,5,6,7 |

Notes:

- Under all conditions VDDQ must be less than or equal to VDD.
- VDDQ tracks with VDD. AC parameters are measured with VDD and VDDQ tied together.
- Maximum DC value may not be greater than 1.425V. The DC value is the linear average of VDD/VDD (t) over a long period of time.
- If the maximum limit is exceeded, the input levels are covered by the DDR3 specification.
- With these supply voltages, the device operates with DDR3L specifications.
- After initialized for DDR3 operation, the DDR3L may be used only upon reset.
- The DDR3L product supports 1.5V operation, and if initialized as such, retains the original speed timings defined for DDR3L speed.

### 3.4 Thermal Resistance

| Package | Substrate | Theta-ja<br>(Airflow = 0m/s) | Theta-ja<br>(Airflow = 1m/s) | Theta-ja<br>(Airflow = 2m/s) | Theta-jc | Units |
|---------|-----------|------------------------------|------------------------------|------------------------------|----------|-------|
| 78-ball | 4-layer   | 47.1                         | 27.1                         | 24.8                         | 4.3      | C/W   |
| 96-ball | 4-layer   | 45.6                         | 26.1                         | 23.8                         | 4.3      | C/W   |

## 4. AC & DC INPUT MEASUREMENT LEVELS

### 4.1. AC and DC Logic Input Levels for Single-Ended Signals

#### 4.1.1 AC and DC Input Levels for Single-Ended Command and Address Signals

| Symbol        | Parameter                                | DDR3-800/1066/1333/1600 |                        | DDR3-1866/2133         |                        | Units | Note    |
|---------------|--|-------------------------|------------------------|------------------------|------------------------|-------|---------|
|               |  | Min.                    | Max.                   | Min.                   | Max.                   |       |         |
| VIH.CA(DC100) | DC input logic high                      | Vref + 0.100            | V <sub>DD</sub>        | Vref + 0.100           | V <sub>DD</sub>        | V     | 1       |
| VIL.CA(DC100) | DC input logic low                       | V <sub>SS</sub>         | Vref - 0.100           | V <sub>SS</sub>        | Vref - 0.100           | V     | 1, 2, 5 |
| VIH.CA(AC175) | AC input logic high                      | Vref + 0.175            | Note2                  | --                     | --                     | V     | 1, 2, 5 |
| VIL.CA(AC175) | AC input logic low                       | Note2                   | Vref - 0.175           | --                     | --                     | V     | 1, 2, 5 |
| VIH.CA(AC150) | AC input logic high                      | Vref + 0.150            | Note2                  | --                     | --                     | V     | 1, 2, 5 |
| VIL.CA(AC150) | AC input logic low                       | Note2                   | Vref - 0.150           | --                     | --                     | V     | 1, 2, 5 |
| VIH.CA(AC135) | AC input logic high                      | --                      | --                     | Vref + 0.135           | Note2                  | V     | 1, 2, 5 |
| VIL.CA(AC135) | AC input logic low                       | --                      | --                     | Note2                  | Vref - 0.135           | V     | 1, 2, 5 |
| VIH.CA(AC125) | AC input logic high                      | --                      | --                     | Vref + 0.125           | Note2                  | V     | 1, 2, 5 |
| VIL.CA(AC125) | AC input logic low                       | --                      | --                     | Note2                  | Vref - 0.125           | V     | 1, 2, 5 |
| VREFCA(DC)    | Reference Voltage for<br>ADD, CMD inputs | 0.49 * V <sub>DD</sub>  | 0.51 * V <sub>DD</sub> | 0.49 * V <sub>DD</sub> | 0.51 * V <sub>DD</sub> | V     | 3, 4    |

| Symbol        | Parameter                                | DDR3L-800/1066/1333/1600 |                        | DDR3L-1866             |                        | Units | Note    |
|---------------|--|--------------------------|------------------------|------------------------|------------------------|-------|---------|
|               |  | Min.                     | Max.                   | Min.                   | Max.                   |       |         |
| VIH.CA(DC90)  | DC input logic high                      | Vref + 0.09              | V <sub>DD</sub>        | Vref + 0.09            | V <sub>DD</sub>        | V     | 1       |
| VIL.CA(DC90)  | DC input logic low                       | V <sub>SS</sub>          | Vref - 0.09            | V <sub>SS</sub>        | Vref - 0.09            | V     | 1, 2, 5 |
| VIH.CA(AC160) | AC input logic high                      | Vref + 0.16              | Note2                  | --                     | --                     | V     | 1, 2, 5 |
| VIL.CA(AC160) | AC input logic low                       | Note2                    | Vref - 0.160           | --                     | --                     | V     | 1, 2, 5 |
| VIH.CA(AC135) | AC input logic high                      | Vref + 0.135             | Note2                  | Vref + 0.135           | Note2                  | V     | 1, 2, 5 |
| VIL.CA(AC135) | AC input logic low                       | Note2                    | Vref - 0.135           | Note2                  | Vref - 0.135           | V     | 1, 2, 5 |
| VIH.CA(AC125) | AC input logic high                      | --                       | --                     | Vref + 0.125           | Note2                  | V     | 1, 2, 5 |
| VIL.CA(AC125) | AC input logic low                       | --                       | --                     | Note2                  | Vref - 0.125           | V     | 1, 2, 5 |
| VREFCA(DC)    | Reference Voltage for<br>ADD, CMD inputs | 0.49 * V <sub>DD</sub>   | 0.51 * V <sub>DD</sub> | 0.49 * V <sub>DD</sub> | 0.51 * V <sub>DD</sub> | V     | 3, 4    |

Notes:

1. For input only pins except RESET. Vref=VrefCA(DC)
2. See "Overshoot and Undershoot Specifications"
3. The ac peak noise on Vref may not allow Vref to deviate from Vref(DC) by more than +/- 1.0% VDD.
4. For reference: DDR3 has approx. V<sub>DD</sub>/2 +/- 15mV, DDR3L has approx V<sub>DD</sub>/2 +/- 13.5mV.
5. To allow VREFCA margining, all DRAM Command and Address Input Buffers MUST use external VREF (provided by system) as the input for their VREFCA pins. All VIH/L input level MUST be compared with the external VREF level at the 1st stage of the Command and Address input buffer

4.1.2 AC and DC Logic Input Levels for Single-Ended Signals & DQ and DM

| Symbol        | Parameter                           | DDR3-800/1066     |                   | DDR3-1333/1600    |                   | DDR3-1866/2133    |                   | Units | Note    |
|---------------|-------------------------------------|-------------------|-------------------|-------------------|-------------------|-------------------|-------------------|-------|---------|
|               |                                     | Min.              | Max.              | Min.              | Max.              | Min.              | Max.              |       |         |
| VIH.DQ(DC100) | DC input logic high                 | $V_{ref} + 0.100$ | $V_{DD}$          | $V_{ref} + 0.100$ | $V_{DD}$          | $V_{ref} + 0.100$ | $V_{DD}$          | V     | 1       |
| VIL.DQ(DC100) | DC input logic low                  | $V_{SS}$          | $V_{ref} - 0.100$ | $V_{SS}$          | $V_{ref} - 0.100$ | $V_{SS}$          | $V_{ref} - 0.100$ | V     | 1, 2, 5 |
| VIH.DQ(AC175) | AC input logic high                 | $V_{ref} + 0.175$ | Note2             | --                | --                | --                | --                | V     | 1, 2, 5 |
| VIL.DQ(AC175) | AC input logic low                  | Note2             | $V_{ref} - 0.175$ | --                | --                | --                | --                | V     | 1, 2, 5 |
| VIH.DQ(AC150) | AC input logic high                 | $V_{ref} + 0.150$ | Note2             | $V_{ref} + 0.150$ | Note2             | --                | --                | V     | 1, 2, 5 |
| VIL.DQ(AC150) | AC input logic low                  | Note2             | $V_{ref} - 0.150$ | Note2             | $V_{ref} - 0.150$ | --                | --                | V     | 1, 2, 5 |
| VIH.DQ(AC135) | AC input logic high                 | $V_{ref} + 0.135$ | Note2             | $V_{ref} + 0.135$ | Note2             | $V_{ref} + 0.135$ | Note2             | V     | 1, 2, 5 |
| VIL.DQ(AC135) | AC input logic low                  | Note2             | $V_{ref} - 0.135$ | Note2             | $V_{ref} - 0.135$ | Note2             | $V_{ref} - 0.135$ | V     | 1, 2, 5 |
| VREFDQ(DC)    | Reference Voltage for DQ, DM inputs | $0.49 * V_{DD}$   | $0.51 * V_{DD}$   | $0.49 * V_{DD}$   | $0.51 * V_{DD}$   | $0.49 * V_{DD}$   | $0.51 * V_{DD}$   | V     | 3, 4    |

| Symbol        | Parameter                           | DDR3L-800/1066         |                        | DDR3L-1333/1600        |                        | DDR3L-1866             |                        | Units | Note    |
|---------------|-------------------------------------|------------------------|------------------------|------------------------|------------------------|------------------------|------------------------|-------|---------|
|               |                                     | Min.                   | Max.                   | Min.                   | Max.                   | Min.                   | Max.                   |       |         |
| VIH.DQ(DC90)  | DC input logic high                 | Vref + 0.09            | V <sub>DD</sub>        | Vref + 0.09            | V <sub>DD</sub>        | Vref + 0.09            | V <sub>DD</sub>        | V     | 1       |
| VIL.DQ(DC90)  | DC input logic low                  | V <sub>SS</sub>        | Vref - 0.09            | V <sub>SS</sub>        | Vref - 0.09            | V <sub>SS</sub>        | Vref - 0.09            | V     | 1, 2, 5 |
| VIH.DQ(AC160) | AC input logic high                 | Vref + 0.16            | Note2                  | Vref + 0.16            | Note2                  | --                     | --                     | V     | 1, 2, 5 |
| VIL.DQ(AC160) | AC input logic low                  | Note2                  | Vref - 0.16            | Note2                  | Vref - 0.16            | --                     | --                     | V     | 1, 2, 5 |
| VIH.DQ(AC135) | AC input logic high                 | Vref + 0.135           | Note2                  | Vref + 0.135           | Note2                  | Vref + 0.135           | Note2                  | V     | 1, 2, 5 |
| VIL.DQ(AC135) | AC input logic low                  | Note2                  | Vref - 0.135           | Note2                  | Vref - 0.135           | Note2                  | Vref - 0.135           | V     | 1, 2, 5 |
| VIH.DQ(AC130) | AC input logic high                 | --                     | --                     | --                     | --                     | Vref + 0.13            | Note2                  | V     | 1, 2, 5 |
| VIL.DQ(AC130) | AC input logic low                  | --                     | --                     | --                     | --                     | Note2                  | Vref - 0.13            | V     | 1, 2, 5 |
| VREFDQ(DC)    | Reference Voltage for DQ, DM inputs | 0.49 * V <sub>DD</sub> | 0.51 * V <sub>DD</sub> | 0.49 * V <sub>DD</sub> | 0.51 * V <sub>DD</sub> | 0.49 * V <sub>DD</sub> | 0.51 * V <sub>DD</sub> | V     | 3, 4    |

Notes:

1. For input only pins except RESET#. Vref = VrefDQ(DC)
2. See "Overshoot and Undershoot Specifications"
3. The ac peak noise on Vref may not allow Vref to deviate from Vref(DC) by more than ± 1.0% VDD.
4. For reference: DDR3 has approx. VDD/2 ± 15mV, and DDR3L has approx. VDD/2 ± 13.5mV.
5. Single-ended swing requirement for DQS-DQS#, is 350mV (peak to peak). Differential swing requirement for DQS-DQS#, is 700mV (peak to peak)

#### 4.2 Vref Tolerances

The dc-tolerance limits and ac-noise limits for the reference voltages VrefCA and VrefDQ are illustrated in the following figure. It shows a valid reference voltage Vref(t) as a function of time. (Vref stands for VrefCA and VrefDQ likewise). Vref(DC) is the linear average of Vref(t) over a very long period of time (e.g., 1 sec). This average has to meet the min/max requirement in previous page. Furthermore Vref(t) may temporarily deviate from Vref(DC) by no more than  $\pm 1\%$  VDD. The voltage levels for setup and hold time measurements VIH(AC), VIH(DC), VIL(AC), and VIL(DC) are dependent on Vref. "Vref" shall be understood as Vref(DC). This clarifies that dc-variations of Vref affect the absolute voltage a signal has to reach to achieve a valid high or low level and therefore the time to which setup and hold is measured. System timing and voltage budgets need to account for Vref(DC) deviations from the optimum position within the data-eye of the input signals.

This also clarifies that the DRAM setup/hold specification and de-rating values need to include time and voltage associated with Vref ac-noise. Timing and voltage effects due to ac-noise on Vref up to the specified limit ( $\pm 1\%$  of VDD) are included in DRAM timing and their associated de-ratings.

Figure 4.2 Illustration of Vref(DC) tolerance and Vrefac-noise limits





4.3. AC and DC Logic Input Levels for Differential Signals

4.3.1 Differential signal definition

Figure 4.3.1 Definition of differential ac-swing and “time above ac-level”



4.3.2 Differential swing requirements for clock (CK - CK#) and strobe (DQS - DQS#)

4.3.2.1 Differential AC and DC Input Levels

| Symbol      | Parameter                     | DDR3-800, 1066, 1333, 1600, 1866, 2133 |                             | unit | Notes |
|-------------|-------------------------------|--|-----------------------------|------|-------|
|             |                               | Min                                    | Max                         |      |       |
| VIHdiff     | Differential input logic high | +0.200                                 | Note3                       | V    | 1     |
| VILdiff     | Differential input logic low  | Note3                                  | -0.200                      | V    | 1     |
| VIHdiff(ac) | Differential input high ac    | $2 \times (VIH(ac) - Vref)$            | Note3                       | V    | 2     |
| VILdiff(ac) | Differential input low ac     | Note3                                  | $2 \times (Vref - VIL(ac))$ | V    | 2     |

| Symbol      | Parameter                     | DDR3L-800, 1066, 1333, 1600, 1866 |                             | unit | Notes |
|-------------|-------------------------------|-----------------------------------|-----------------------------|------|-------|
|             |                               | Min                               | Max                         |      |       |
| VIHdiff     | Differential input logic high | +0.180                            | Note3                       | V    | 1     |
| VILdiff     | Differential input logic low  | Note3                             | -0.180                      | V    | 1     |
| VIHdiff(ac) | Differential input high ac    | $2 \times (VIH(ac) - Vref)$       | Note3                       | V    | 2     |
| VILdiff(ac) | Differential input low ac     | Note3                             | $2 \times (Vref - VIL(ac))$ | V    | 2     |

- Notes:
- Used to define a differential signal slew-rate.
  - For CK - CK# use VIH/VIL(ac) of ADD/CMD and VREFCA; for DQS - DQS#, DQSL, DQSL#, DQSU, DQSU# use VIH/VIL(ac) of DQs and VREFDQ; if a reduced ac-high or ac-low level is used for a signal group, then the reduced level applies also here.
  - These values are not defined; however, the single-ended signals CK, CK#, DQS, DQS#, DQSL, DQSL#, DQSU, DQSU# need to be within the respective limits (VIH(dc) max, VIL(dc)min) for single-ended signals as well as the limitations for overshoot and undershoot.

4.3.2.2 Minimum required time before ringback (tDVAC) for CK - CK# and DQS - DQS#

| Slew Rate [V/ns] | DDR3-800/1066/1333/1600              |                                      |  | DDR3-1866/2133                       |  |
|------------------|--------------------------------------|--------------------------------------|--|--------------------------------------|--|
|                  | tDVAC [ps] @  VIH/Ldiff(AC)  = 350mV | tDVAC [ps] @  VIH/Ldiff(AC)  = 300mV | tDVAC [ps] @  VIH/Ldiff(AC)  = (DQS - DQS#) only | tDVAC [ps] @  VIH/Ldiff(AC)  = 300mV | tDVAC [ps] @  VIH/Ldiff(AC)  = (CK - CK#) only |
| > 4.0            | 75                                   | 175                                  | 214  | 134                                  | 139  |
| 4                | 57                                   | 170                                  | 214  | 134                                  | 139  |
| 3                | 50                                   | 167                                  | 191  | 112                                  | 118  |
| 2                | 38                                   | 119                                  | 146  | 67                                   | 77   |
| 1.8              | 34                                   | 102                                  | 131  | 52                                   | 63   |
| 1.6              | 29                                   | 81                                   | 113  | 33                                   | 45   |
| 1.4              | 22                                   | 54                                   | 88   | 9                                    | 23   |
| 1.2              | Note                                 | 19                                   | 56   | Note                                 | Note   |
| 1                | Note                                 | Note                                 | 11   | Note                                 | Note   |
| < 1              | Note                                 | Note                                 | Note   | Note                                 | Note   |

| Slew Rate [V/ns] | DDR3L-800/1066/1333/1600             |                                      |                                      | DDR3L-1866                           |                                      |
|------------------|--------------------------------------|--------------------------------------|--------------------------------------|--------------------------------------|--------------------------------------|
|                  | tDVAC [ps] @  VIH/Ldiff(AC)  = 320mV | tDVAC [ps] @  VIH/Ldiff(AC)  = 270mV | tDVAC [ps] @  VIH/Ldiff(AC)  = 270mV | tDVAC [ps] @  VIH/Ldiff(AC)  = 250mV | tDVAC [ps] @  VIH/Ldiff(AC)  = 260mV |
| > 4.0            | 189                                  | 201                                  | 163                                  | 168                                  | 176                                  |
| 4                | 189                                  | 201                                  | 163                                  | 168                                  | 176                                  |
| 3                | 162                                  | 179                                  | 140                                  | 147                                  | 154                                  |
| 2                | 109                                  | 134                                  | 95                                   | 105                                  | 111                                  |
| 1.8              | 91                                   | 119                                  | 80                                   | 91                                   | 97                                   |
| 1.6              | 69                                   | 100                                  | 62                                   | 74                                   | 78                                   |
| 1.4              | 40                                   | 76                                   | 37                                   | 52                                   | 56                                   |
| 1.2              | Note                                 | 44                                   | 5                                    | 22                                   | 24                                   |
| 1                | Note                                 | Note                                 | Note                                 | Note                                 | Note                                 |
| < 1              | Note                                 | Note                                 | Note                                 | Note                                 | Note                                 |

Note: The rising input differential signal shall become equal to or greater than VIHdiff(ac) level; and the falling input differential signal shall become equal to or less than VILdiff(ac) level.

### 4.3.3. Single-ended requirements for differential signals

Each individual component of a differential signal (CK, DQS, DQSL, DQSU, CK#, DQS#, DQSL#, or DQSU#) has also to comply with certain requirements for single-ended signals.

CK and CK# have to approximately reach VSEHmin / VSELmax (approximately equal to the ac-levels (VIH(ac) / VIL(ac) ) for ADD/CMD signals) in every half-cycle. DQS, DQSL, DQSU, DQS#, DQSL# have to reach VSEHmin / VSELmax (approximately the ac-levels (VIH(ac) / VIL(ac) ) for DQ signals) in every half-cycle preceding and following a valid transition.

#### 4.3.3.1. Single-ended levels for CK, DQS, DQSL, DQSU, CK#, DQS#, DQSL# or DQSU#

| Symbol | Parameter                           | DDR3/DDR3L-800, 1066, 1333, & 1600 |                    | Unit | Notes |
|--------|-------------------------------------|------------------------------------|--------------------|------|-------|
|        |                                     | Min                                | Max                |      |       |
| VSEH   | Single-ended high-level for strobes | $(VDDQ/2) + 0.175$                 | note3              | V    | 1, 2  |
|        | Single-ended high-level for CK, CK  | $(VDDQ/2) + 0.175$                 | note3              | V    | 1, 2  |
| VSEL   | Single-ended low-level for strobes  | note3                              | $(VDDQ/2) - 0.175$ | V    | 1, 2  |
|        | Single-ended Low-level for CK, CK   | note3                              | $(VDDQ/2) - 0.175$ | V    | 1, 2  |

- Notes:
- For CK, CK# use VIH/VIL(ac) of ADD/CMD; for strobes (DQS, DQS#, DQSL, DQSL#, DQSU, DQSU#) use VIH/VIL(ac) of DQs.
  - VIH(ac)/VIL(ac) for DQs is based on VREFDQ; VIH(ac)/VIL(ac) for ADD/CMD is based on VREFCA; if a reduced ac-high or ac-low level is used for a signal group, then the reduced level applies also here
  - These values are not defined, however the single-ended signals CK, CK#, DQS, DQS#, DQSL, DQSL#, DQSU, DQSU# need to be within the respective limits (VIH(dc) max, VIL(dc)min) for single-ended signals as well as the limitations for overshoot and undershoot.

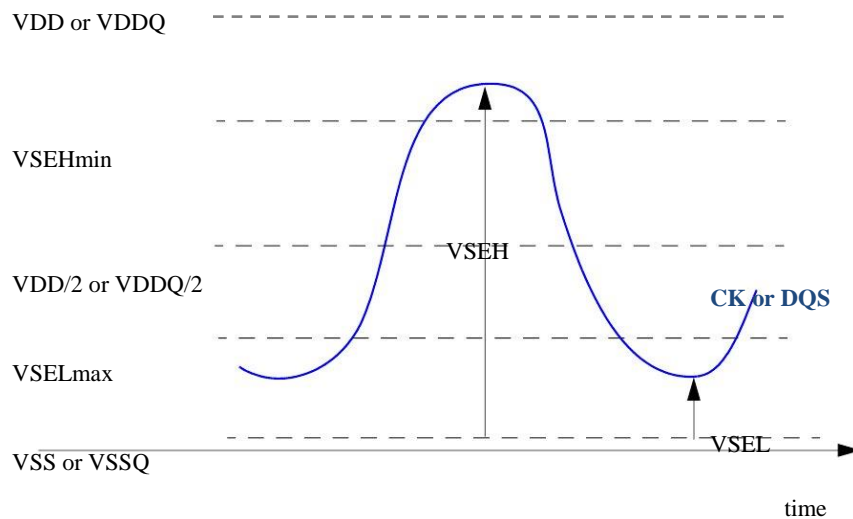

Figure 4.3.3 Single-ended requirement for differential signals.

#### 4.4 Differential Input Cross Point Voltage

To guarantee tight setup and hold times as well as output skew parameters with respect to clock and strobe, each cross point voltage of differential input signals (CK, CK and DQS, DQS) must meet the requirements in the following table. The differential input cross point voltage  $V_{ix}$  is measured from the actual cross point of true and complement signal to the midlevel between of VDD and VSS.



Figure 4.4.  $V_{ix}$  Definition

#### 4.4.1 Cross point voltage for differential input signals (CK, DQS)

| Symbol   | Parameter  |       | DDR3/DDR3L-800,<br>1066, 1333, 1600, 1866, 2133 |      | Unit | Note |
|----------|--|-------|---|------|------|------|
|          |  |       | Min.  | Max. |      |      |
| $V_{ix}$ | Differential Input Cross Point Voltage relative to $V_{DD}/2$ for CK, CK   | DDR3  | -150  | 150  | mV   | 2    |
|          |  | DDR3L | -175  | 175  | mV   | 1    |
|          | Differential Input Cross Point Voltage relative to $V_{DD}/2$ for DQS, DQS | DDR3  | -150  | 150  | mV   | 2    |
|          |  | DDR3L | -150  | 150  | mV   | 2    |

- Notes:
- Extended range for  $V_{ix}$  is only allowed for clock and if single-ended clock input signals CK and CK# are monotonic with a single-ended swing  $V_{SEL} / V_{SEH}$  of at least  $V_{DD}/2 \pm 250$  mV, and when the differential slew rate of CK - CK# is larger than 3 V/ns.
  - The following must be true:  $(V_{DD}/2) + V_{ix}(\min) - V_{SEL} \geq 25$  mV and  $V_{SEH} - ((V_{DD}/2) + V_{ix}(\max.)) \geq 25$  mV.

#### 4.5 Slew Rate Definitions for Single-Ended Input Signals

See "Address / Command Setup, Hold and Derating" for single-ended slew rate definitions for address and command signals.

See "Data Setup, Hold and Slew Rate Derating" for single-ended slew rate definitions for data signals.

4.6. Slew Rate Definition for Differential Input Signals

4.6.1 Differential Input Slew Rate Definition

| Description   | Measured   |            | Defined by                                  |
|---|------------|------------|---|
|   | From       | To         |   |
| Differential input slew rate for rising edge (CK-CK# & DQS-DQS#)  | VILdiffmax | VIHdiffmin | $[VIHdiffmin - VILdiffmax] / \Delta TRdiff$ |
| Differential input slew rate for falling edge (CK-CK# & DQS-DQS#) | VIHdiffmin | VILdiffmax | $[VIHdiffmin - VILdiffmax] / \Delta TFdiff$ |

Note : The differential signal (i.e., CK-CK# & DQS-DQS#) must be linear between these thresholds.



Figure 4.6.1 Input Nominal Slew Rate Definition for DQS, DQS# and CK, CK#

## 5. AC AND DC OUTPUT MEASUREMENT LEVELS

### 5.1 Single Ended AC and DC Output Levels

| Symbol  | Parameter   | Value        | Unit | Notes |
|---------|---|--------------|------|-------|
| VOH(DC) | DC output high measurement level (for IV curve linearity) | 0.8xVDDQ     | V    |       |
| VOM(DC) | DC output mid measurement level (for IV curve linearity)  | 0.5xVDDQ     | V    |       |
| VOL(DC) | DC output low measurement level (fro IV curve linearity)  | 0.2xVDDQ     | V    |       |
| VOH(AC) | AC output high measurement level (for output SR)          | VTT+0.1xVDDQ | V    | 1     |
| VOL(AC) | AC output low measurement level (for output SR)           | VTT-0.1xVDDQ | V    | 1     |

NOTE 1. The swing of  $\pm 0.1 \times VDDQ$  is based on approximately 50% of the static single-ended output high or low swing with a driver impedance of  $40\Omega$  and an effective test load of  $25\Omega$  to  $VTT = VDDQ/2$ .

### 5.2 Differential AC and DC Output Levels

| Symbol      | Parameter   | Value       | Unit | Notes |
|-------------|---|-------------|------|-------|
| VOHdiff(AC) | AC differential output high measurement level (for output SR) | +0.2 x VDDQ | V    | 1     |
| VOLdiff(AC) | AC differential output low measurement level (for output SR)  | -0.2 x VDDQ | V    | 1     |

NOTE 1. The swing of  $\pm 0.2 \times VDDQ$  is based on approximately 50% of the static single-ended output high or low swing with a driver impedance of  $40\Omega$  and an effective test load of  $25\Omega$  to  $VTT = VDDQ/2$  at each of the differential outputs.

### 5.3 Single Ended Output Slew Rate

#### 5.3.1 Single Ended Output Slew Rate Definition

| Description                                    | Measured |         | Defined by                        |
|--|----------|---------|-----------------------------------|
|  | From     | To      |                                   |
| Single ended output slew rate for rising edge  | VOL(AC)  | VOH(AC) | $[VOH(AC)-VOL(AC)] / \Delta TRse$ |
| Single ended output slew rate for falling edge | VOH(AC)  | VOL(AC) | $[VOH(AC)-VOL(AC)] / \Delta TFse$ |



Figure 5.3.1 Single Ended Output Slew Rate Definition

#### 5.3.2 Output Slew Rate (single-ended)

| Parameter                     |       | Symbol | DDR3-800 |      | DDR3-1066 |      | DDR3-1333 |      | DDR3-1600 |      | DDR3-1866 |      | DDR3-2133 |      | Unit |
|-------------------------------|-------|--------|----------|------|-----------|------|-----------|------|-----------|------|-----------|------|-----------|------|------|
|                               |       |        | Min.     | Max. | Min.      | Max. | Max.      | Max. | Max.      | Max. | Max.      | Max. | Max.      | Max. |      |
| Single-ended Output Slew Rate | DDR3  | SRQse  | 2.5      | 5    | 2.5       | 5    | 2.5       | 5    | 2.5       | 5    | 2.5       | 5    | 2.5       | 5    | V/ns |
|                               | DDR3L |        | 1.75     | 5    | 1.75      | 5    | 1.75      | 5    | 1.75      | 5    | 1.75      | 5    | 1.75      | 5    |      |

Note: SR: Slew Rate. Q: Query Output (like in DQ, which stands for Data-in, Query -Output). se: Single-ended signals. For Ron = RZQ/7 setting.

## 5.4 Differential Output Slew Rate

### 5.4.1 Differential Output Slew Rate Definition

| Description                               | Measured    |             | Defined by                                |
|---|-------------|-------------|---|
|   | From        | To          |   |
| Differential output slew rate for rising  | VOLdiff(AC) | VOHdiff(AC) | $[VOHdiff(AC)-VOLdiff(AC)]/\Delta TRdiff$ |
| Differential output slew rate for falling | VOHdiff(AC) | VOLdiff(AC) | $[VOHdiff(AC)-VOLdiff(AC)]/\Delta TFdiff$ |

Note: Output slew rate is verified by design and characterization, and not 100% tested in production.



Figure 5.4.1 Differential Output Slew Rate Definition

### 5.4.2 Differential Output Slew Rate

| Parameter                     |       | Symbol  | DDR3-800 |      | DDR3-1066 |      | DDR3-1333 |      | DDR3-1600 |      | DDR3-1866 |      | DDR3-2133 |      | Unit |
|-------------------------------|-------|---------|----------|------|-----------|------|-----------|------|-----------|------|-----------|------|-----------|------|------|
|                               |       |         | Min.     | Max. | Min.      | Max. | Max.      | Max. | Max.      | Max. | Max.      | Max. | Max.      | Max. |      |
| Differential Output Slew Rate | DDR3  | SRQdiff | 5        | 10   | 5         | 10   | 5         | 10   | 5         | 10   | 5         | 10   | 5         | 10   | V/ns |
|                               | DDR3L |         | 3.5      | 12   | 3.5       | 12   | 3.5       | 12   | 3.5       | 12   | 3.5       | 12   | 3.5       | 12   |      |

Description: SR: Slew Rate, Q: Query Output (like in DQ, which stands for Data-in, Query-Output), diff: Differential Signals, For Ron = RZQ/7 setting

## 5.5 Reference Load for AC Timing and Output Slew Rate

The following figure represents the effective reference load of 25 ohms used in defining the relevant AC timing parameters of the device as well as output slew rate measurements. It is not intended as a precise representation of any particular system environment or a depiction of the actual load presented by a production tester. System designers should use IBIS or other simulation tools to correlate the timing reference load to a system environment. Manufacturers correlate to their production test conditions, generally one or more coaxial transmission lines terminated at the tester electronics.

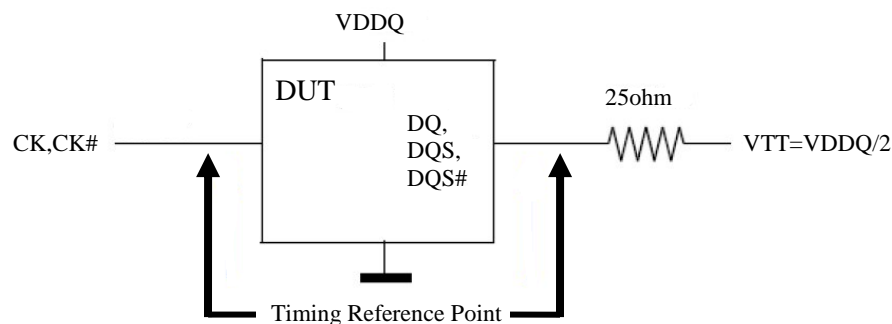

Figure 5.5 Reference Load for AC Timing and Output Slew Rate



## 5.6 Overshoot and Undershoot Specifications

### 5.6.1 AC Overshoot/Undershoot Specification for Address and Control Pins

| Item   | DDR3-800 | DDR3-1066 | DDR3-1333 | DDR3-1600 | DDR3-1866 | DDR3-2133 | Units |
|--|----------|-----------|-----------|-----------|-----------|-----------|-------|
| Maximum peak amplitude allowed for overshoot area  | 0.4      | 0.4       | 0.4       | 0.4       | 0.4       | 0.4       | V     |
| Maximum peak amplitude allowed for undershoot area | 0.4      | 0.4       | 0.4       | 0.4       | 0.4       | 0.4       | V     |
| Maximum overshoot area above VDD                   | 0.67     | 0.5       | 0.4       | 0.33      | 0.28      | 0.25      | V-ns  |
| undershoot area below VSS                          | 0.67     | 0.5       | 0.4       | 0.33      | 0.28      | 0.25      | V-ns  |

Note : A0-A13, BA0-BA2, CS#, RAS#, CAS#, WE#, CKE, ODT

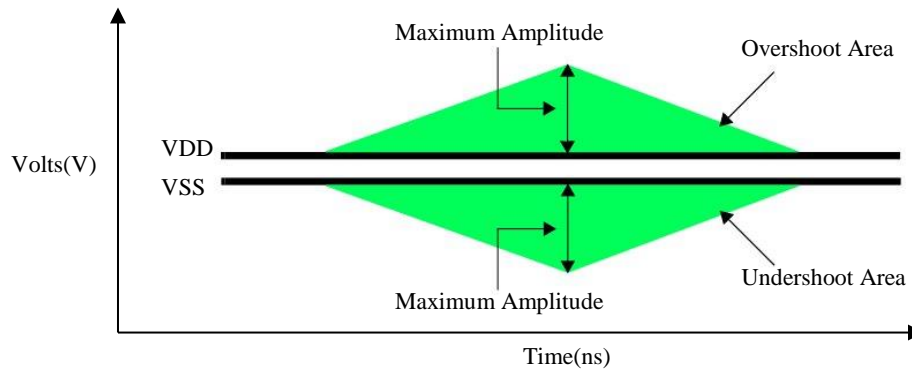

### 5.6.2 AC Overshoot/Undershoot Specification for Clock, Data, Strobe, and Mask

| Item   | DDR3-800 | DDR3-1066 | DDR3-1333 | DDR3-1600 | DDR3-1866 | DDR3-2133 | Units |
|--|----------|-----------|-----------|-----------|-----------|-----------|-------|
| Maximum peak amplitude allowed for overshoot area  | 0.4      | 0.4       | 0.4       | 0.4       | 0.4       | 0.4       | V     |
| Maximum peak amplitude allowed for undershoot area | 0.4      | 0.4       | 0.4       | 0.4       | 0.4       | 0.4       | V     |
| Maximum overshoot area above VDD                   | 0.25     | 0.19      | 0.15      | 0.13      | 0.11      | 0.10      | V-ns  |
| undershoot area below VSS                          | 0.25     | 0.19      | 0.15      | 0.13      | 0.11      | 0.10      | V-ns  |

Note : CK, CK#, DQ, DQS, DQS#, DM

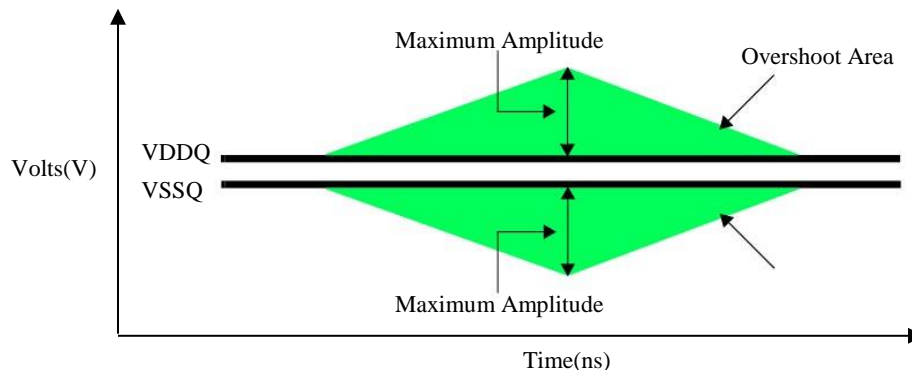

## 5.7 340hm Output Driver DC Electrical Characteristics

A Functional representation of the output driver is shown as below. Output driver impedance RON is defined by the value of the external reference resistor RZQ as follows:

$$RON34 = RZQ / 7 \text{ (nominal 34.4ohms +/-10% with nominal RZQ=240ohms)}$$

The individual pull-up and pull-down resistors (RONPu and RONPd) are defined as follows:

$$RONPu = [VDDQ - Vout] / |Iout| \text{ ----- under the condition that RONPd is turned off (1)}$$

$$RONPd = Vout / |Iout| \text{ ----- under the condition that RONPu is turned off (2)}$$

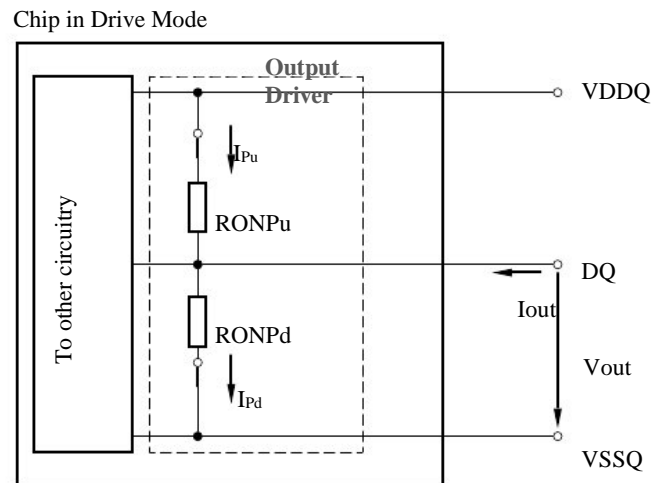

Figure 5.7 Output Driver : Definition of Voltages and Currents

### 5.7.1 Output Driver DC Electrical Characteristics

DDR3 (assuming 1.5V, RZQ = 240ohms; entire operating temperature range; after proper ZQ calibration)

| RONNom   | Resistor | Vout                       | Min | Nom | Max | Unit  | Notes |
|--|----------|----------------------------|-----|-----|-----|-------|-------|
| 34 ohms  | RON34Pd  | $VOL_{dc}=0.2 \times VDDQ$ | 0.6 | 1   | 1.1 | RZQ/7 | 1,2,3 |
|  |          | $VOM_{dc}=0.5 \times VDDQ$ | 0.9 | 1   | 1.1 | RZQ/7 | 1,2,3 |
|  |          | $VOH_{dc}=0.8 \times VDDQ$ | 0.9 | 1   | 1.4 | RZQ/7 | 1,2,3 |
|  | RON34Pu  | $VOL_{dc}=0.2 \times VDDQ$ | 0.9 | 1   | 1.4 | RZQ/7 | 1,2,3 |
|  |          | $VOM_{dc}=0.5 \times VDDQ$ | 0.9 | 1   | 1.1 | RZQ/7 | 1,2,3 |
|  |          | $VOH_{dc}=0.8 \times VDDQ$ | 0.6 | 1   | 1.1 | RZQ/7 | 1,2,3 |
| 40 ohms  | RON40Pd  | $VOL_{dc}=0.2 \times VDDQ$ | 0.6 | 1   | 1.1 | RZQ/6 | 1,2,3 |
|  |          | $VOM_{dc}=0.5 \times VDDQ$ | 0.9 | 1   | 1.1 | RZQ/6 | 1,2,3 |
|  |          | $VOH_{dc}=0.8 \times VDDQ$ | 0.9 | 1   | 1.4 | RZQ/6 | 1,2,3 |
|  | RON40Pu  | $VOL_{dc}=0.2 \times VDDQ$ | 0.9 | 1   | 1.4 | RZQ/6 | 1,2,3 |
|  |          | $VOM_{dc}=0.5 \times VDDQ$ | 0.9 | 1   | 1.1 | RZQ/6 | 1,2,3 |
|  |          | $VOH_{dc}=0.8 \times VDDQ$ | 0.6 | 1   | 1.1 | RZQ/6 | 1,2,3 |
| Mismatch between pull-up and pull-down, MMPuPd |          | $VOM_{dc}=0.5 \times VDDQ$ | -10 |     | +10 | %     | 1,2,4 |

DDR3L (assuming 1.35V, RZQ = 240ohms; entire operating temperature range; after proper ZQ calibration)

| RONNom   | Resistor | Vout            | Min | Nom | Max  | Unit  | Notes |
|--|----------|-----------------|-----|-----|------|-------|-------|
| 34 ohms  | RON34Pd  | VOLdc=0.2xVDDQ  | 0.6 | 1   | 1.15 | RZQ/7 | 1,2,3 |
|  |          | VOMdc=0.5xVDDQ  | 0.9 | 1   | 1.15 | RZQ/7 | 1,2,3 |
|  |          | VOHdc =0.8xVDDQ | 0.9 | 1   | 1.45 | RZQ/7 | 1,2,3 |
|  | RON34Pu  | VOLdc=0.2xVDDQ  | 0.9 | 1   | 1.45 | RZQ/7 | 1,2,3 |
|  |          | VOMdc=0.5xVDDQ  | 0.9 | 1   | 1.15 | RZQ/7 | 1,2,3 |
|  |          | VOHdc=0.8xVDDQ  | 0.6 | 1   | 1.15 | RZQ/7 | 1,2,3 |
| 40 ohms  | RON40Pd  | VOLdc=0.2xVDDQ  | 0.6 | 1   | 1.15 | RZQ/6 | 1,2,3 |
|  |          | VOMdc=0.5xVDDQ  | 0.9 | 1   | 1.15 | RZQ/6 | 1,2,3 |
|  |          | VOHdc =0.8xVDDQ | 0.9 | 1   | 1.45 | RZQ/6 | 1,2,3 |
|  | RON40Pu  | VOLdc=0.2xVDDQ  | 0.9 | 1   | 1.45 | RZQ/6 | 1,2,3 |
|  |          | VOMdc=0.5xVDDQ  | 0.9 | 1   | 1.15 | RZQ/6 | 1,2,3 |
|  |          | VOHdc=0.8xVDDQ  | 0.6 | 1   | 1.15 | RZQ/6 | 1,2,3 |
| Mismatch between pull-up and pull-down, MMPuPd |          | VOMdc= 0.5xVDDQ | -10 |     | +10  | %     | 1,2,4 |

Notes:

1. The tolerance limits are specified after calibration with stable voltage and temperature. For the behavior of the tolerance limits if temperature or voltage changes after calibration, see following section on voltage and temperature sensitivity.
2. The tolerance limits are specified under the condition that VDDQ=VDD and that VSSQ=VSS.
3. Pull-down and pull-up output driver impedances are recommended to be calibrated at 0.5xVDDQ. Other calibration schemes may be used to achieve the linearity spec shown above, e.g. calibration at 0.2 \* VDDQ and 0.8 x VDDQ.
4. Measurement definition for mismatch between pull-up and pull-down, MMPuPd:  
Measure RONPu and RONPd, both at 0.5 x VDDQ:  
MMPuPd = [RONPu - RONPd] / RONNom x 100

**5.7.2 Output Driver Temperature and Voltage sensitivity**

If temperature and/or voltage after calibration, the tolerance limits widen according to the following table below.

$\Delta T = T - T(@\text{calibration}); \Delta V = VDDQ - VDDQ(@\text{calibration}); VDD = VDDQ$

**5.7.2.1 Output Driver Sensitivity Definition**

| Items       | Min.  | Max.  | Unit  |
|-------------|---|---|-------|
| RONPU@VOHdc | 0.6 - dRONdTH*IDelta TI - dRONdVH*IDelta VI | 1.1 + dRONdTH*IDelta TI - dRONdVH*IDelta VI | RZQ/7 |
| RON@VOMdc   | 0.9 - dRONdTM*IDelta TI - dRONdVM*IDelta VI | 1.1 + dRONdTM*IDelta TI - dRONdVM*IDelta VI | RZQ/7 |
| RONPD@VOLdc | 0.6 - dRONdTL*IDelta TI - dRONdVL*IDelta VI | 1.1 + dRONdTL*IDelta TI - dRONdVL*IDelta VI | RZQ/7 |

Note: dRONdT and dRONdV are not subject to production test but are verified by design and characterization.

**5.7.2.2 Output Driver Voltage and Temperature Sensitivity**

| Speed Bin | DDR3-800/1066/1333 |      | DDR3-1600/1866/2133 |      | Unit |
|-----------|--------------------|------|---------------------|------|------|
|           | Min.               | Max  | Min.                | Max  |      |
| dRONdTM   | 0                  | 1.5  | 0                   | 1.5  | %/°C |
| dRONdVM   | 0                  | 0.15 | 0                   | 0.13 | %/mV |
| dRONdTL   | 0                  | 1.5  | 0                   | 1.5  | %/°C |
| dRONdVL   | 0                  | 0.15 | 0                   | 0.13 | %/mV |
| dRONdTH   | 0                  | 1.5  | 0                   | 1.5  | %/°C |
| dRONdVH   | 0                  | 0.15 | 0                   | 0.13 | %/mV |

Note: dRONdT and dRONdV are not subject to production test but are verified by design and characterization.

**5.8 On-Die Termination (ODT) Levels and I-V Characteristics**

**5.8.1 On-Die Termination (ODT) Levels and I-V Characteristics**

On-Die Termination effective resistance  $R_{TT}$  is defined by bits A9, A6, and A2 of the MR1 Register.

ODT is applied to the DQ, DM, DQS/DQS, and TDQS/TDQS (x8 devices only) pins.

A functional representation of the on-die termination is shown in the following figure. The individual pull-up and pull-down resistors ( $R_{TTPu}$  and  $R_{TTPd}$ ) are defined as follows:

$$R_{TTPu} = [VDDQ - V_{out}] / |I_{out}| \text{ ----- under the condition that } R_{TTPd} \text{ is turned off (3)}$$

$$R_{TTPd} = V_{out} / |I_{out}| \text{ ----- under the condition that } R_{TTPu} \text{ is turned off (4)}$$

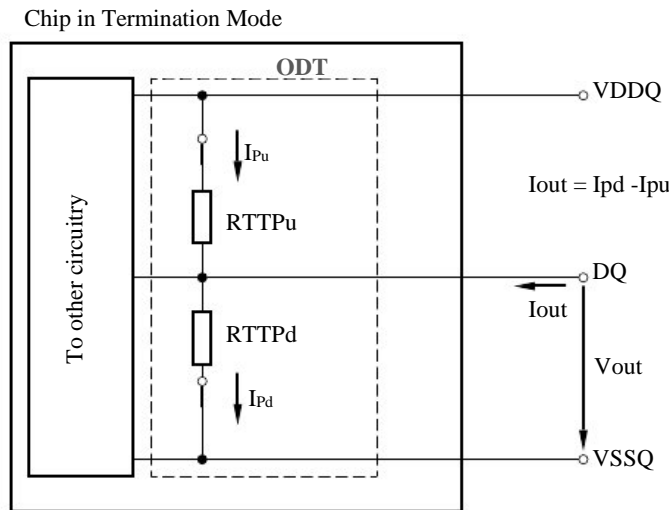

Figure 5.8.1 On-Die Termination : Definition of Voltages and Currents

**5.8.2 ODT DC Electrical Characteristics**

The following table provides an overview of the ODT DC electrical characteristics. The values for  $R_{TT60Pd120}$ ,  $R_{TT60Pu120}$ ,  $R_{TT120Pd240}$ ,  $R_{TT120Pu240}$ ,  $R_{TT40Pd80}$ ,  $R_{TT40Pu80}$ ,  $R_{TT30Pd60}$ ,  $R_{TT30Pu60}$ ,  $R_{TT20Pd40}$ ,  $R_{TT20Pu40}$  are not specification requirements, but can be used as design guide lines:

**ODT DC Electrical Characteristics**

(assuming RZQ = 240ohms +/- 1% entire operating temperature range; after proper ZQ calibration)

| MR1 A9, A6, A2                    | RTT                | Resistor    | Vout               | Min | Nom  | Max (DDR3) | Max (DDR3L) | Unit  | Notes   |
|-----------------------------------|--------------------|-------------|--------------------|-----|------|------------|-------------|-------|---------|
| 0,1,0                             | 120Ω               | RTT120Pd240 | VOLdc = 0.2 x VDDQ | 0.6 | 1    | 1.1        | 1.15        | RZQ   | 1,2,3,4 |
|                                   |                    |             | 0.5 x VDDQ         | 0.9 | 1    | 1.1        | 1.15        | RZQ   | 1,2,3,4 |
|                                   |                    |             | VOHdc = 0.8 x VDDQ | 0.9 | 1    | 1.4        | 1.45        | RZQ   | 1,2,3,4 |
|                                   |                    | RTT120Pu240 | VOLdc = 0.2 x VDDQ | 0.9 | 1    | 1.4        | 1.45        | RZQ   | 1,2,3,4 |
|                                   |                    |             | 0.5 x VDDQ         | 0.9 | 1    | 1.1        | 1.15        | RZQ   | 1,2,3,4 |
|                                   |                    |             | VOHdc = 0.8 x VDDQ | 0.6 | 1    | 1.1        | 1.15        | RZQ   | 1,2,3,4 |
| RTT120                            | VIL(ac) to VIH(ac) | 0.9         | 1                  | 1.6 | 1.65 | RZQ/2      | 1,2,5       |       |         |
| 0,0,1                             | 60Ω                | RTT60Pd120  | VOLdc = 0.2 x VDDQ | 0.6 | 1    | 1.1        | 1.15        | RZQ/2 | 1,2,3,4 |
|                                   |                    |             | 0.5 x VDDQ         | 0.9 | 1    | 1.1        | 1.15        | RZQ/2 | 1,2,3,4 |
|                                   |                    |             | VOHdc = 0.8 x VDDQ | 0.9 | 1    | 1.4        | 1.45        | RZQ/2 | 1,2,3,4 |
|                                   |                    | RTT60Pu120  | VOLdc = 0.2 x VDDQ | 0.9 | 1    | 1.4        | 1.45        | RZQ/2 | 1,2,3,4 |
|                                   |                    |             | 0.5 x VDDQ         | 0.9 | 1    | 1.1        | 1.15        | RZQ/2 | 1,2,3,4 |
|                                   |                    |             | VOHdc = 0.8 x VDDQ | 0.6 | 1    | 1.1        | 1.15        | RZQ/2 | 1,2,3,4 |
| RTT60                             | VIL(ac) to VIH(ac) | 0.9         | 1                  | 1.6 | 1.65 | RZQ/4      | 1,2,5       |       |         |
| 0,1,1                             | 40Ω                | RTT40Pd80   | VOLdc = 0.2 x VDDQ | 0.6 | 1    | 1.1        | 1.15        | RZQ/3 | 1,2,3,4 |
|                                   |                    |             | 0.5 x VDDQ         | 0.9 | 1    | 1.1        | 1.15        | RZQ/3 | 1,2,3,4 |
|                                   |                    |             | VOHdc = 0.8 x VDDQ | 0.9 | 1    | 1.4        | 1.45        | RZQ/3 | 1,2,3,4 |
|                                   |                    | RTT40Pu80   | VOLdc = 0.2 x VDDQ | 0.9 | 1    | 1.4        | 1.45        | RZQ/3 | 1,2,3,4 |
|                                   |                    |             | 0.5 x VDDQ         | 0.9 | 1    | 1.1        | 1.15        | RZQ/3 | 1,2,3,4 |
|                                   |                    |             | VOHdc = 0.8 x VDDQ | 0.6 | 1    | 1.1        | 1.15        | RZQ/3 | 1,2,3,4 |
| RTT40                             | VIL(ac) to VIH(ac) | 0.9         | 1                  | 1.6 | 1.65 | RZQ/6      | 1,2,5       |       |         |
| 1,0,1                             | 30Ω                | RTT30Pd60   | VOLdc = 0.2 x VDDQ | 0.6 | 1    | 1.1        | 1.15        | RZQ/4 | 1,2,3,4 |
|                                   |                    |             | 0.5 x VDDQ         | 0.9 | 1    | 1.1        | 1.15        | RZQ/4 | 1,2,3,4 |
|                                   |                    |             | VOHdc = 0.8 x VDDQ | 0.9 | 1    | 1.4        | 1.45        | RZQ/4 | 1,2,3,4 |
|                                   |                    | RTT30Pu60   | VOLdc = 0.2 x VDDQ | 0.9 | 1    | 1.4        | 1.45        | RZQ/4 | 1,2,3,4 |
|                                   |                    |             | 0.5 x VDDQ         | 0.9 | 1    | 1.1        | 1.15        | RZQ/4 | 1,2,3,4 |
|                                   |                    |             | VOHdc = 0.8 x VDDQ | 0.6 | 1    | 1.1        | 1.15        | RZQ/4 | 1,2,3,4 |
| RTT30                             | VIL(ac) to VIH(ac) | 0.9         | 1                  | 1.6 | 1.65 | RZQ/8      | 1,2,5       |       |         |
| 1,0,0                             | 20Ω                | RTT20Pd40   | VOLdc = 0.2 x VDDQ | 0.6 | 1    | 1.1        | 1.15        | RZQ/6 | 1,2,3,4 |
|                                   |                    |             | 0.5 x VDDQ         | 0.9 | 1    | 1.1        | 1.15        | RZQ/6 | 1,2,3,4 |
|                                   |                    |             | VOHdc = 0.8 x VDDQ | 0.9 | 1    | 1.4        | 1.45        | RZQ/6 | 1,2,3,4 |
|                                   |                    | RTT20Pu40   | VOLdc = 0.2 x VDDQ | 0.9 | 1    | 1.4        | 1.45        | RZQ/6 | 1,2,3,4 |
|                                   |                    |             | 0.5 x VDDQ         | 0.9 | 1    | 1.1        | 1.15        | RZQ/6 | 1,2,3,4 |
|                                   |                    |             | VOHdc = 0.8 x VDDQ | 0.6 | 1    | 1.1        | 1.15        | RZQ/6 | 1,2,3,4 |
| RTT20                             | VIL(ac) to VIH(ac) | 0.9         | 1                  | 1.6 | 1.65 | RZQ/12     | 1,2,5       |       |         |
| Deviation of VM w.r.t VDDQ/2, DVM |                    |             |                    | -5  | -    | +5         | +5          | %     | 1,2,5,6 |

- Notes:
- The tolerance limits are specified after calibration with stable voltage and temperature. For the behavior of the tolerance limits if temperature or voltage changes after calibration, see following section on voltage and temperature sensitivity.
  - The tolerance limits are specified under the condition that VDDQ = VDD and that VSSQ = VSS.
  - Pull-down and pull-up ODT resistors are recommended to be calibrated at 0.5 x VDDQ. Other calibration schemes may be used to achieve the linearity spec shown above.
  - Not a specification requirement, but a design guide line.
  - Measurement definition for RTT:  
Apply VIH(ac) to pin under test and measure current I(VIH(ac)), then apply VIL(ac) to pin under test and measure current I(VIL(ac)) respectively.  
RTT = [VIH(ac) - VIL(ac)] / [I(VIH(ac)) - I(VIL(ac))]
  - Measurement definition for VM and DVM:  
Measure voltage (VM) at test pin (midpoint) with no load: Delta VM = [2VM / VDDQ - 1] x 100

### 5.8.3 ODT Temperature and Voltage sensitivity

If temperature and/or voltage after calibration, the tolerance limits widen according to the following table.  
Delta T = T - T(@calibration); Delta V = VDDQ - VDDQ(@calibration); VDD = VDDQ

#### 5.8.3.1 ODT Sensitivity Definition

|     | min   | max   | Unit           |
|-----|---|---|----------------|
| RTT | $0.9 - dRTTdT * \Delta T - dRTTdV * \Delta V$ | $1.6 + dRTTdT * \Delta T + dRTTdV * \Delta V$ | RZQ/2,4,6,8,12 |

#### 5.8.3.2 ODT Voltage and Temperature Sensitivity

|        | Min | Max  | Unit |
|--------|-----|------|------|
| dRTTdT | 0   | 1.5  | %/°C |
| dRTTdV | 0   | 0.15 | %/mV |

Note: These parameters may not be subject to production test. They are verified by design and characterization

## 5.9 ODT Timing Definitions

### 5.9.1 Test Load for ODT Timings

Different than for timing measurements, the reference load for ODT timings is defined in the following figure.

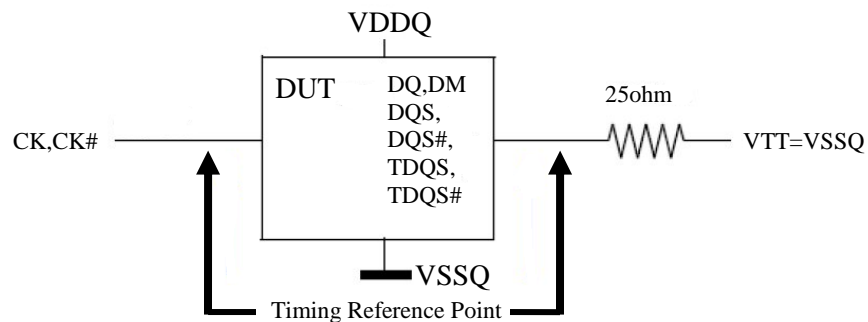

Figure 5.9.1 ODT Timing Reference Load

### 5.9.2 ODT Timing Definitions

Definitions for  $t_{AON}$ ,  $t_{AONPD}$ ,  $t_{AOF}$ ,  $t_{AOFPD}$ , and  $t_{ADC}$  are provided in the following table and subsequent figures.

| Symbol      | Begin Point Definition  | End Point Definition   |
|-------------|---|--|
| $t_{AON}$   | Rising edge of CK - CK defined by the end point of ODTLon                         | Extrapolated point at VSSQ   |
| $t_{AONPD}$ | Rising edge of CK - CK with ODT being first registered high                       | Extrapolated point at VSSQ   |
| $t_{AOF}$   | Rising edge of CK - CK defined by the end point of ODTLoff                        | End point: Extrapolated point at $V_{RTT\_Nom}$                                |
| $t_{AOFPD}$ | Rising edge of CK - CK with ODT being first registered low                        | End point: Extrapolated point at $V_{RTT\_Nom}$                                |
| $t_{ADC}$   | Rising edge of CK - CK defined by the end point of ODTLcwn, ODTLcwn4, or ODTLcwn8 | End point: Extrapolated point at $V_{RTT\_Wr}$ and $V_{RTT\_Nom}$ respectively |

### Reference Settings for ODT Timing Measurements

| Measured Parameter | RTT_Nom Setting | RTT_Wr Setting | VSW1[V] | VSW2[V] |      |
|--------------------|-----------------|----------------|---------|---------|------|
| $t_{AON}$          | RZQ/4           | NA             | 0.05    | 0.10    |      |
|                    | RZQ/12          | NA             | 0.10    | 0.20    |      |
| $t_{AONPD}$        | RZQ/4           | NA             | 0.05    | 0.10    |      |
|                    | RZQ/12          | NA             | 0.10    | 0.20    |      |
| $t_{AOFPD}$        | RZQ/4           | NA             | 0.05    | 0.10    |      |
|                    | RZQ/12          | NA             | 0.10    | 0.20    |      |
| $t_{ADC}$          | DDR3            | RZQ/12         | RZQ/2   | 0.20    | 0.30 |
|                    | DDR3L           | RZQ/12         | RZQ/2   | 0.20    | 0.25 |

Figure 5.9.2.1 Definition of  $t_{AON}$

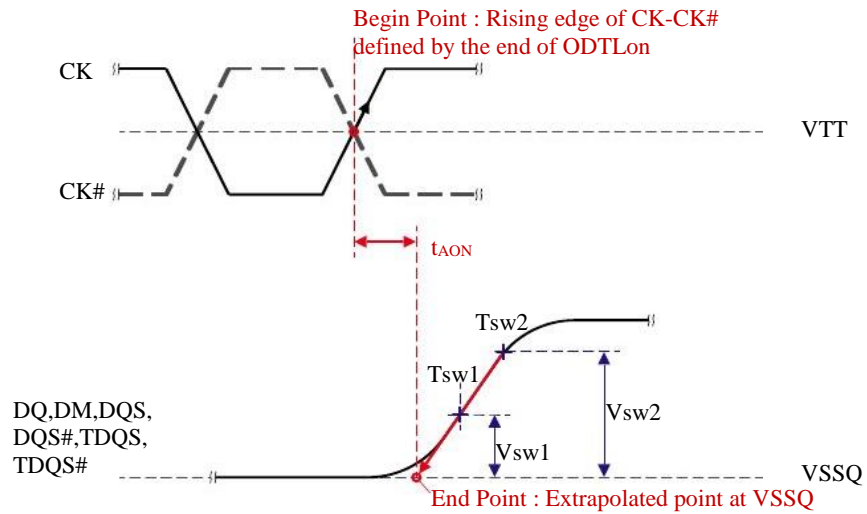

Figure 5.9.2.2 Definition of  $t_{AONPD}$

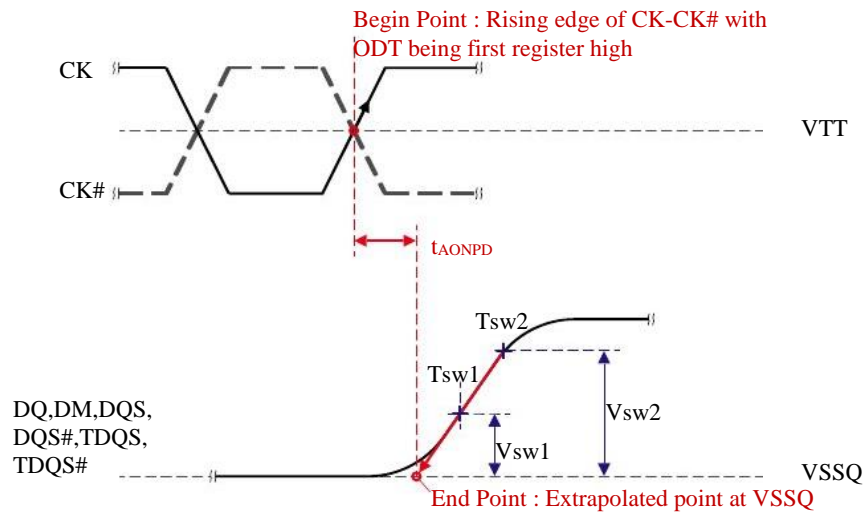



Figure 5.9.2.3 Definition of  $t_{AOF}$

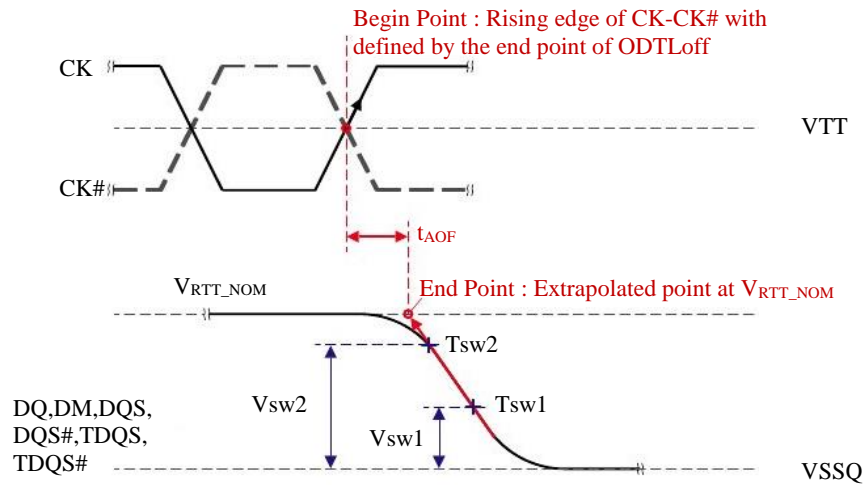

Figure 5.9.2.4 Definition of  $t_{AOFPD}$

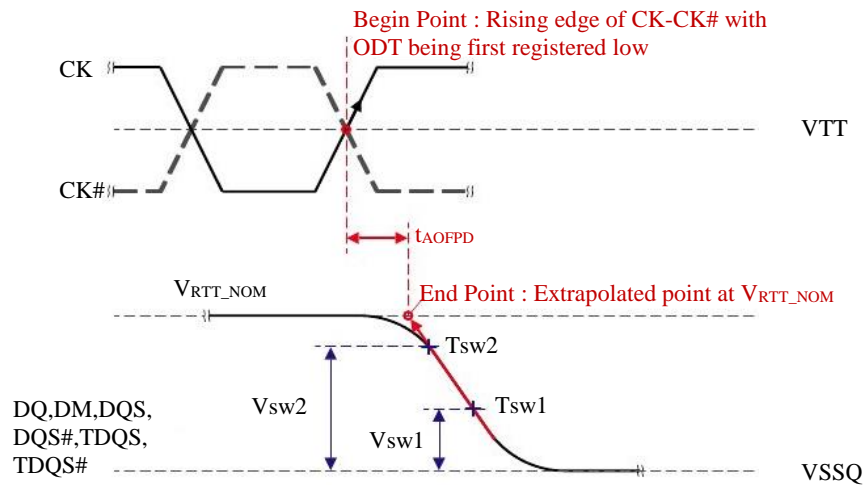
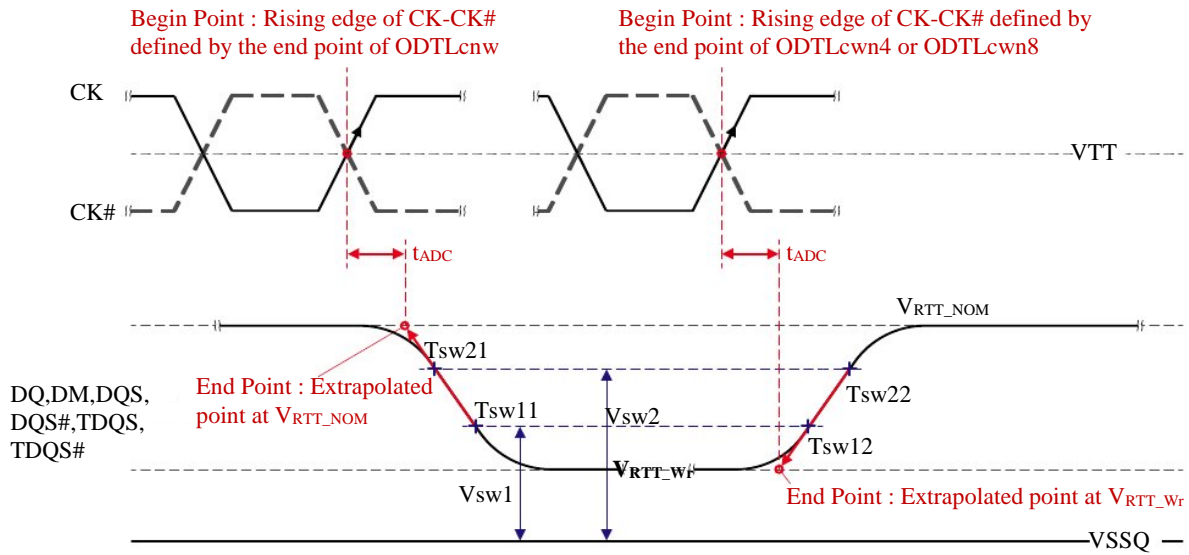

Figure 5.9.2.5 Definition of  $t_{ADC}$



**6. INPUT / OUTPUT CAPACITANCE**

| Symbol                  | Parameter   | DDR3/<br>DDR3L-800 |      | DDR3/<br>DDR3L-1066 |      | DDR3/<br>DDR3L-1333 |      | DDR3/<br>DDR3L-1600 |      | DDR3/<br>DDR3L-1866 |      | DDR3-2133 |      | Units | Notes    |         |
|-------------------------|---|--------------------|------|---------------------|------|---------------------|------|---------------------|------|---------------------|------|-----------|------|-------|----------|---------|
|                         |   | Min                | Max  | Min                 | Max  | Min                 | Max  | Min                 | Max  | Min                 | Max  | Min       | Max  |       |          |         |
| C <sub>IO</sub>         | Input/output capacitance (DQ, DM, DQS, DQS#, TDQS#)           | DDR3               | 1.4  | 3                   | 1.4  | 2.7                 | 1.4  | 2.5                 | 1.4  | 2.3                 | 1.4  | 2.2       | 1.4  | 2.1   | pF       | 1,2,3   |
|                         |   | DDR3L              | 1.4  | 2.5                 | 1.4  | 2.5                 | 1.4  | 2.3                 | 1.4  | 2.2                 | 1.4  | 2.1       | -    | -     |          |         |
| C <sub>CK</sub>         | Input capacitance, CK and CK#                                 | 0.8                | 1.6  | 0.8                 | 1.6  | 0.8                 | 1.4  | 0.8                 | 1.4  | 0.8                 | 1.3  | 0.8       | 1.3  | pF    | 2,3      |         |
| C <sub>DCK</sub>        | Input capacitance delta, CK and CK#                           | 0                  | 0.15 | 0                   | 0.15 | 0                   | 0.15 | 0                   | 0.15 | 0                   | 0.15 | 0         | 0.15 | pF    | 2,3,4    |         |
| C <sub>DDQS</sub>       | Input/output capacitance delta, DQS and DQS#                  | 0                  | 0.15 | 0                   | 0.15 | 0                   | 0.15 | 0                   | 0.15 | 0                   | 0.15 | 0         | 0.15 | pF    | 2,3,5    |         |
| C <sub>I</sub>          | Input capacitance, CTRL, ADD, command input-only pins         | DDR3               | 0.75 | 1.4                 | 0.75 | 1.35                | 0.75 | 1.3                 | 0.75 | 1.3                 | 0.75 | 1.2       | 0.75 | 1.2   | pF       | 2,3,7,8 |
|                         |   | DDR3L              | 0.75 | 1.3                 | 0.75 | 1.3                 | 0.75 | 1.3                 | 0.75 | 1.2                 | 0.75 | 1.2       | -    | -     |          |         |
| C <sub>DL_CTRL</sub>    | Input capacitance delta, all CTRL input-only pins             | -0.5               | 0.3  | -0.5                | 0.3  | -0.4                | 0.2  | -0.4                | 0.2  | -0.4                | 0.2  | -0.4      | 0.2  | pF    | 2,3,7,8  |         |
| C <sub>DL_ADD_CMD</sub> | Input capacitance delta, all ADD/CMD input-only pins          | -0.5               | 0.5  | -0.5                | 0.5  | -0.4                | 0.4  | -0.4                | 0.4  | -0.4                | 0.4  | -0.4      | 0.4  | pF    | 2,3,9,10 |         |
| C <sub>DIO</sub>        | Input/output capacitance delta, DQ, DM, DQS, DQS# TDQS, TDQS# | -0.5               | 0.3  | -0.5                | 0.3  | -0.5                | 0.3  | -0.5                | 0.3  | -0.5                | 0.3  | -0.5      | 0.3  | pF    | 2,3,11   |         |
| C <sub>ZQ</sub>         | Input/output capacitance of ZQ pin                            | -                  | 3    | -                   | 3    | -                   | 3    | -                   | 3    | -                   | 3    | -         | 3    | pF    | 2,3,12   |         |

Notes:

1. Although the DM, TDQS and TDQS# pins have different functions, the loading matches DQ and DQS
2. This parameter is not subject to production test. It is verified by design and characterization. VDD=VDDQ=1.5V, VBIAS=VDD/2 and on-die termination off.
3. This parameter applies to monolithic devices only; stacked/dual-die devices are not covered here
4. Absolute value of C<sub>CK</sub>-C<sub>CK#</sub>
5. Absolute value of C<sub>IO</sub>(DQS)-C<sub>IO</sub>(DQS#)
6. C<sub>I</sub> applies to ODT, CS#, CKE, A0-A14, BA0-BA2, RAS#, CAS#, WE#.
7. C<sub>DL\_CTRL</sub> applies to ODT, CS# and CKE
8. C<sub>DL\_CTRL</sub>=C<sub>I</sub>(CTRL)-0.5\*(C<sub>I</sub>(CK)+C<sub>I</sub>(CK#))
9. C<sub>DL\_ADD\_CMD</sub> applies to A0-A14, BA0-BA2, RAS#, CAS# and WE#
10. C<sub>DL\_ADD\_CMD</sub>=C<sub>I</sub>(ADD\_CMD) - 0.5\*(C<sub>I</sub>(CK)+C<sub>I</sub>(CK#))
11. C<sub>DIO</sub>=C<sub>IO</sub>(DQ,DM) - 0.5\*(C<sub>IO</sub>(DQS)+C<sub>IO</sub>(DQS#))
12. Maximum external load capacitance on ZQ pin: 5 pF.

7. IDD SPECIFICATIONS AND MEASUREMENT CONDITIONS

IDD Specifications (x8), 1.5 Operation Voltage

| Symbol | Parameter/Condition  | DDR3-1066 | DDR3-1333 | DDR3-1600 | DDR3-1866 | Unit |
|--------|--|-----------|-----------|-----------|-----------|------|
|        |  | Max.      | Max.      | Max.      | Max.      |      |
| IDD0   | Operating Current 0<br>-> One Bank Activate-><br>Precharge           | 77        | 80        | 84        | 100       | mA   |
| IDD1   | Operating Current 1<br>-> One Bank Activate-><br>Read-><br>Precharge | 99        | 102       | 107       | 135       | mA   |
| IDD2P0 | Precharge Power-Down<br>Current<br>Slow Exit - MR0 bit A12 = 0       | 20        | 20        | 21        | 21        | mA   |
| IDD2P1 | Precharge Power-Down<br>Current<br>Fast Exit - MR0 bit A12 = 1       | 20        | 20        | 21        | 21        | mA   |
| IDD2PQ | Precharge Quiet Standby<br>Current                                   | 51        | 56        | 60        | 70        | mA   |
| IDD2N  | Precharge Standby Current  | 53        | 57        | 60        | 65        | mA   |
| IDD3P  | Active Power-Down Current<br>Always Fast Exit                        | 32        | 32        | 32        | 40        | mA   |
| IDD3N  | Active Standby Current   | 71        | 75        | 80        | 85        | mA   |
| IDD4R  | Operating Current Burst Read   | 147       | 155       | 170       | 210       | mA   |
| IDD4W  | Operating Current Burst Write  | 147       | 162       | 185       | 230       | mA   |
| IDD5B  | Burst Refresh Current  | 216       | 274       | 329       | 384       | mA   |
| IDD6   | Self-Refresh Current Normal<br>Temperature Range (0-85°C)            | 18        | 18        | 18        | 18        | mA   |
| IDD6ET | Self-Refresh Current:<br>extended<br>temperature range               | 21        | 21        | 21        | 21        | mA   |
| IDD7   | All Bank Interleave Read<br>Current                                  | 222       | 245       | 275       | 310       | mA   |

Note:

1. 1066 is for reference only
2. Values applicable for all temperature grades; see Component Operating Temperature Range, section 3.2.

**IDD Specifications (x16), 1.5 Operation Voltage**

| Symbol | Parameter/Condition  | DDR3-1066 | DDR3-1333 | DDR3-1600 | DDR3-1866 | Unit |
|--------|--|-----------|-----------|-----------|-----------|------|
|        |  | Max.      | Max.      | Max.      | Max.      |      |
| IDD0   | Operating Current 0<br>-> One Bank Activate-><br>Precharge           | 101       | 105       | 108       | 123       | mA   |
| IDD1   | Operating Current 1<br>-> One Bank Activate-><br>Read-><br>Precharge | 131       | 134       | 138       | 155       | mA   |
| IDD2P0 | Precharge Power-Down<br>Current<br>Slow Exit - MR0 bit A12 = 0       | 20        | 20        | 21        | 21        | mA   |
| IDD2P1 | Precharge Power-Down<br>Current<br>Fast Exit - MR0 bit A12 = 1       | 20        | 20        | 21        | 21        | mA   |
| IDD2PQ | Precharge Quiet Standby<br>Current                                   | 51        | 56        | 60        | 70        | mA   |
| IDD2N  | Precharge Standby Current  | 66        | 71        | 75        | 80        | mA   |
| IDD3P  | Active Power-Down Current<br>Always Fast Exit                        | 45        | 45        | 47        | 58        | mA   |
| IDD3N  | Active Standby Current   | 98        | 101       | 105       | 110       | mA   |
| IDD4R  | Operating Current Burst Read   | 221       | 233       | 255       | 298       | mA   |
| IDD4W  | Operating Current Burst Write  | 221       | 240       | 270       | 319       | mA   |
| IDD5B  | Burst Refresh Current  | 218       | 274       | 329       | 384       | mA   |
| IDD6   | Self-Refresh Current Normal<br>Temperature Range (0-85°C)            | 18        | 18        | 18        | 18        | mA   |
| IDD6ET | Self-Refresh Current:<br>extended<br>temperature range               | 21        | 21        | 21        | 21        | mA   |
| IDD7   | All Bank Interleave Read<br>Current                                  | 308       | 330       | 362       | 430       | mA   |

Note:

1. 1066 is for reference only
2. Values applicable for all temperature grades; see Component Operating Temperature Range, section 3.2.

IDD Specifications (x8), 1.35 Operation Voltage

| Symbol | Parameter/Condition   | DDR3L-1066 | DDR3L-1333 | DDR3L-1600 | DDR3L-1866 | Unit |
|--------|---|------------|------------|------------|------------|------|
|        |   | Max.       | Max.       | Max.       | Max.       |      |
| IDD0   | Operating Current 0<br>-> One Bank Activate-> Precharge           | 77         | 80         | 84         | 100        | mA   |
| IDD1   | Operating Current 1<br>-> One Bank Activate-> Read-><br>Precharge | 99         | 102        | 107        | 135        | mA   |
| IDD2P0 | Precharge Power-Down Current<br>Slow Exit - MR0 bit A12 = 0       | 20         | 20         | 21         | 21         | mA   |
| IDD2P1 | Precharge Power-Down Current<br>Fast Exit - MR0 bit A12 = 1       | 20         | 20         | 21         | 21         | mA   |
| IDD2PQ | Precharge Quiet Standby Current                                   | 51         | 56         | 60         | 70         | mA   |
| IDD2N  | Precharge Standby Current   | 53         | 57         | 60         | 65         | mA   |
| IDD3P  | Active Power-Down Current<br>Always Fast Exit                     | 32         | 32         | 32         | 40         | mA   |
| IDD3N  | Active Standby Current  | 71         | 75         | 80         | 85         | mA   |
| IDD4R  | Operating Current Burst Read                                      | 147        | 155        | 170        | 210        | mA   |
| IDD4W  | Operating Current Burst Write                                     | 147        | 162        | 185        | 230        | mA   |
| IDD5B  | Burst Refresh Current   | 216        | 274        | 329        | 384        | mA   |
| IDD6   | Self-Refresh Current Normal<br>Temperature Range (0-85°C)         | 18         | 18         | 18         | 18         | mA   |
| IDD6ET | Self-Refresh Current: extended<br>temperature range               | 21         | 21         | 21         | 21         | mA   |
| IDD7   | All Bank Interleave Read Current                                  | 222        | 245        | 275        | 310        | mA   |

Note:

1. 1066 is for reference only
2. Values applicable for all temperature grades; see Component Operating Temperature Range, section 3.2.

**IDD Specifications (x16), 1.35 Operation Voltage**

| Symbol | Parameter/Condition   | DDR3L-1066 | DDR3L-1333 | DDR3L-1600 | DDR3L-1866 | Unit |
|--------|---|------------|------------|------------|------------|------|
|        |   | Max.       | Max.       | Max.       | Max.       |      |
| IDD0   | Operating Current 0<br>-> One Bank Activate-> Precharge           | 101        | 105        | 108        | 123        | mA   |
| IDD1   | Operating Current 1<br>-> One Bank Activate-> Read-><br>Precharge | 131        | 134        | 138        | 155        | mA   |
| IDD2P0 | Precharge Power-Down Current<br>Slow Exit - MR0 bit A12 = 0       | 20         | 20         | 21         | 21         | mA   |
| IDD2P1 | Precharge Power-Down Current<br>Fast Exit - MR0 bit A12 = 1       | 20         | 20         | 21         | 21         | mA   |
| IDD2PQ | Precharge Quiet Standby Current                                   | 51         | 56         | 60         | 70         | mA   |
| IDD2N  | Precharge Standby Current   | 66         | 71         | 75         | 80         | mA   |
| IDD3P  | Active Power-Down Current<br>Always Fast Exit                     | 45         | 45         | 47         | 58         | mA   |
| IDD3N  | Active Standby Current  | 98         | 101        | 105        | 110        | mA   |
| IDD4R  | Operating Current Burst Read                                      | 221        | 233        | 235        | 298        | 298  |
| IDD4W  | Operating Current Burst Write                                     | 221        | 240        | 270        | 319        | mA   |
| IDD5B  | Burst Refresh Current   | 218        | 274        | 329        | 384        | mA   |
| IDD6   | Self-Refresh Current Normal<br>Temperature Range (0-85°C)         | 18         | 18         | 18         | 18         | mA   |
| IDD6ET | Self-Refresh Current: extended<br>temperature range               | 21         | 21         | 21         | 21         | mA   |
| IDD7   | All Bank Interleave Read Current                                  | 308        | 330        | 362        | 430        | mA   |

Note:

1. 1066 is for reference only
2. Values applicable for all temperature grades; see Component Operating Temperature Range, section 3.2.



## 8. Electrical Characteristics and AC timing for DDR3-800 to DDR3-1600

### 8.1 Clock Specification

The jitter specified is a random jitter meeting a Gaussian distribution. Input clocks violating the min/max values may result in malfunction of the DDR3 SDRAM device.

#### 8.1.1 Definition for tCK(avg)

tCK(avg) is calculated as the average clock period across any consecutive 200 cycle window, where each clock period is calculated from rising edge to rising edge.

$$tCK(avg) = \left( \sum_{j=1}^N tCK_j \right) / N$$

Where N=200

#### 8.1.2 Definition for tCK(abs)

tCK(abs) is defined as the absolute clock period, as measured from one rising edge to the next consecutive rising edge. tCK(abs) is not subject to production test.

#### 8.1.3 Definition for tCH(avg) and tCL(avg)

tCH(avg) is defined as the average high pulse width, as calculated across any consecutive 200 high pulses:

$$tCH(avg) = \left( \sum_{j=1}^N tCH_j \right) / (N \times tCK(avg))$$

Where N=200

tCL(avg) is defined as the average low pulse width, as calculated across any consecutive 200 low pulses:

$$tCL(avg) = \left( \sum_{j=1}^N tCL_j \right) / (N \times tCK(avg))$$

Where N=200

#### 8.1.4 Definition for note for tJIT(per), tJIT(per, lck)

tJIT(per) is defined as the largest deviation of any single tCK from tCK(avg).

tJIT(per) = min/max of {tCK<sub>i</sub>-tCK(avg) where i=1 to 200}

tJIT(per) defines the single period jitter when the DLL is already locked.

tJIT(per,lck) uses the same definition for single period jitter, during the DLL locking period only.

tJIT(per) and tJIT(per,lck) are not subject to production test.

### 8.1.5 Definition for tJIT(cc), tJIT(cc, lck)

tJIT(cc) is defined as the absolute difference in clock period between two consecutive clock cycles:  $tJIT(cc) = \text{Max of } \{|tCK_{i+1} - tCK_i|\}$

tJIT(cc) defines the cycle to cycle jitter when the DLL is already locked.

tJIT(cc,lck) uses the same definition for cycle to cycle jitter, during the DLL locking period only.

tJIT(cc) and tJIT(cc,lck) are not subject to production test.

### 8.1.6 Definition for tERR(nper)

tERR is defined as the cumulative error across n multiple consecutive cycles from tCK(avg). tERR is not subject to production test.

## 8.2 Refresh Parameters

### Refresh parameters<sup>(1)</sup>

| Parameter                                   | Symbol |                      | Units  |
|---|--------|----------------------|--------|
| All Bank Refresh to active/refresh cmd time | tRFC   | 160                  | ns     |
| Average periodic refresh interval           | tREFI  | -40°C ≤ TCASE ≤ 85°C | 7.8 μs |
|   |        | 85°C < TCASE ≤ 105°C | 3.9 μs |

Notes:

- The permissible Tcase (Tc) operating temperature is specified by temperature grade. The maximum Tc is 95°C unless A2 grade, for which the maximum is 105°C. Refer to 3.2 Component Operating Temperature Range

## 8.3 Speed Bins and CL, tRCD, tRP, tRC and tRAS for corresponding Bin

DDR3-1066MT/s

| Speed Bin                                |        | DDR3/DDR3L-1066 |          | Unit  |    |
|--|--------|-----------------|----------|-------|----|
| CL-nRCD-nRP                              |        | 7-7-7 (-187F)   |          |       |    |
| Parameter                                | Symbol | Min             | Max      |       |    |
| Internal read command to first data      | tAA    | 13.125          | 20.000   | ns    |    |
| ACT to internal read or write delay time | tRCD   | 13.125          | -        | ns    |    |
| PRE command period                       | tRP    | 13.125          | -        | ns    |    |
| ACT to ACT or REF command period         | tRC    | 50.625          | -        | ns    |    |
| ACT to PRE command period                | tRAS   | 37.500          | 9*tREFI  | ns    |    |
| CL=5                                     | CWL=5  | tCK(AVG)        | 3.000    | 3.300 | ns |
|  | CWL=6  | tCK(AVG)        | Reserved |       | ns |
| CL=6                                     | CWL=5  | tCK(AVG)        | 2.500    | 3.300 | ns |
|  | CWL=6  | tCK(AVG)        | Reserved |       | ns |
| CL=7                                     | CWL=5  | tCK(AVG)        | Reserved |       | ns |
|  | CWL=6  | tCK(AVG)        | 1.875    | <2.5  | ns |
| CL=8                                     | CWL=5  | tCK(AVG)        | Reserved |       | ns |
|  | CWL=6  | tCK(AVG)        | 1.875    | <2.5  | ns |
| Supported CL Settings                    |        | 5,6,7,8         |          | nCK   |    |
| Supported CWL Settings                   |        | 5,6             |          | nCK   |    |

DDR3-1333MT/s

| Speed Bin                           |        | DDR3/DDR3L-1333 |          | Unit   |    |
|-------------------------------------|--------|-----------------|----------|--------|----|
| CL-nRCD-nRP                         |        | 9-9-9 (-15H)    |          |        |    |
| Parameter                           | Symbol | Min             | Max      |        |    |
| Internal read command to first data | tAA    | 13.5            | 20       | ns     |    |
| ACT to internal read or write delay | tRCD   | 13.5            | -        | ns     |    |
| PRE command period                  | tRP    | 13.5            | -        | ns     |    |
| ACT to ACT or REF period            | tRC    | 49.5            | -        | ns     |    |
| ACT to PRE command period           | tRAS   | 36.0            | 9*tREFI  | ns     |    |
| CL=5                                | CWL=5  | tCK(AVG)        | 3.0      | 3.3    | ns |
|                                     | CWL=6  | tCK(AVG)        | Reserved |        | ns |
|                                     | CWL=7  | tCK(AVG)        | Reserved |        | ns |
| CL=6                                | CWL=5  | tCK(AVG)        | 2.5      | 3.3    | ns |
|                                     | CWL=6  | tCK(AVG)        | Reserved |        | ns |
|                                     | CWL=7  | tCK(AVG)        | Reserved |        | ns |
| CL=7                                | CWL=5  | tCK(AVG)        | Reserved |        | ns |
|                                     | CWL=6  | tCK(AVG)        | 1.875    | <2.5   | ns |
|                                     | CWL=7  | tCK(AVG)        | Reserved |        | ns |
| CL=8                                | CWL=5  | tCK(AVG)        | Reserved |        | ns |
|                                     | CWL=6  | tCK(AVG)        | 1.875    | <2.5   | ns |
|                                     | CWL=7  | tCK(AVG)        | Reserved |        | ns |
| CL=9                                | CWL=5  | tCK(AVG)        | Reserved |        | ns |
|                                     | CWL=6  | tCK(AVG)        | Reserved |        | ns |
|                                     | CWL=7  | tCK(AVG)        | 1.5      | <1.875 | ns |
| CL=10                               | CWL=5  | tCK(AVG)        | Reserved |        | ns |
|                                     | CWL=6  | tCK(AVG)        | Reserved |        | ns |
|                                     | CWL=7  | tCK(AVG)        | 1.5      | <1.875 | ns |
| Supported CL Settings               |        | 5,6,7,8,9,10    |          | nCK    |    |
| Supported CWL Settings              |        | 5,6,7           |          | nCK    |    |

Note : \*: Optional

DDR3-1600MT/s

| Speed Bin                           |        | DDR3/DDR3L-1600  |          | Unit |    |
|-------------------------------------|--------|------------------|----------|------|----|
| CL-nRCD-nRP                         |        | 11-11-11 (-125K) |          |      |    |
| Parameter                           | Symbol | Min              | Max      |      |    |
| Internal read command to first data | tAA    | 13.75            | 20       | ns   |    |
| ACT to internal read or write delay | tRCD   | 13.75            | -        | ns   |    |
| PRE command period                  | tRP    | 13.75            | -        | ns   |    |
| ACT to ACT or REF period            | tRC    | 48.75            | -        | ns   |    |
| ACT to PRE command period           | tRAS   | 35               | 9*tREFI  | ns   |    |
| CL=5                                | CWL=5  | tCK(AVG)         | 3.0      | 3.3  | ns |
|                                     | CWL=6  | tCK(AVG)         | Reserved |      | ns |
|                                     | CWL=7  | tCK(AVG)         | Reserved |      | ns |
|                                     | CWL=8  | tCK(AVG)         | Reserved |      | ns |
| CL=6                                | CWL=5  | tCK(AVG)         | 2.5      | 3.3  | ns |
|                                     | CWL=6  | tCK(AVG)         | Reserved |      | ns |
|                                     | CWL=7  | tCK(AVG)         | Reserved |      | ns |
|                                     | CWL=8  | tCK(AVG)         | Reserved |      | ns |

|                        |        |          |                 |        |     |
|------------------------|--------|----------|-----------------|--------|-----|
| CL=7                   | CWL =5 | tCK(AVG) | Reserved        |        | ns  |
|                        | CWL=6  | tCK(AVG) | 1.875           | <2.5   | ns  |
|                        | CWL=7  | tCK(AVG) | Reserved        |        | ns  |
|                        | CWL=8  | tCK(AVG) | Reserved        |        | ns  |
| CL=8                   | CWL =5 | tCK(AVG) | Reserved        |        | ns  |
|                        | CWL=6  | tCK(AVG) | 1.875           | <2.5   | ns  |
|                        | CWL=7  | tCK(AVG) | Reserved        |        | ns  |
|                        | CWL=8  | tCK(AVG) | Reserved        |        | ns  |
| CL=9                   | CWL =5 | tCK(AVG) | Reserved        |        | ns  |
|                        | CWL=6  | tCK(AVG) | Reserved        |        | ns  |
|                        | CWL=7  | tCK(AVG) | 1.5             | <1.875 | ns  |
|                        | CWL=8  | tCK(AVG) | Reserved        |        | ns  |
| CL=10                  | CWL =5 | tCK(AVG) | Reserved        |        | ns  |
|                        | CWL=6  | tCK(AVG) | Reserved        |        | ns  |
|                        | CWL=7  | tCK(AVG) | 1.5             | <1.875 | ns  |
|                        | CWL =8 | tCK(AVG) | Reserved        |        | ns  |
| CL=11                  | CWL =5 | tCK(AVG) | Reserved        |        | ns  |
|                        | CWL= 6 | tCK(AVG) | Reserved        |        | ns  |
|                        | CWL= 7 | tCK(AVG) | Reserved        |        | ns  |
|                        | CWL =8 | tCK(AVG) | 1.250           | <1.5   | ns  |
| Supported CL Settings  |        |          | 5,6,7,8,9,10,11 |        | nCK |
| Supported CWL Settings |        |          | 5,6,7,8         |        | nCK |

Note : \*: Optional

DDR3-1866MT/s

| Speed Bin                           |         | DDR3/DDR3L-1866  |          | Unit |    |
|-------------------------------------|---------|------------------|----------|------|----|
| CL-nRCD-nRP                         |         | 13-13-13 (-107M) |          |      |    |
| Parameter                           | Symbol  | Min              | Max      |      |    |
| Internal read command to first data | tAA     | 13.91            | 20       | ns   |    |
| ACT to internal read or write delay | tRCD    | 13.91            | -        | ns   |    |
| PRE command period                  | tRP     | 13.91            | -        | ns   |    |
| ACT to ACT or REF period            | tRC     | 47.91            | -        | ns   |    |
| ACT to PRE command period           | tRAS    | 34               | 9*tREFI  | ns   |    |
| CL=5                                | CWL =5  | tCK(AVG)         | Reserved |      | ns |
|                                     | CWL=6   | tCK(AVG)         | Reserved |      | ns |
|                                     | CWL=7   | tCK(AVG)         | Reserved |      | ns |
|                                     | CWL=8,9 | tCK(AVG)         | Reserved |      | ns |
| CL=6                                | CWL =5  | tCK(AVG)         | 2.5      | 3.3  | ns |
|                                     | CWL=6   | tCK(AVG)         | Reserved |      | ns |
|                                     | CWL=7   | tCK(AVG)         | Reserved |      | ns |
|                                     | CWL=8,9 | tCK(AVG)         | Reserved |      | ns |
| CL=7                                | CWL =5  | tCK(AVG)         | Reserved |      | ns |
|                                     | CWL=6   | tCK(AVG)         | 1.875    | <2.5 | ns |
|                                     | CWL=7   | tCK(AVG)         | Reserved |      | ns |
|                                     | CWL=8,9 | tCK(AVG)         | Reserved |      | ns |
| CL=8                                | CWL =5  | tCK(AVG)         | Reserved |      | ns |
|                                     | CWL=6   | tCK(AVG)         | 1.875    | <2.5 | ns |
|                                     | CWL=7   | tCK(AVG)         | Reserved |      | ns |
|                                     | CWL=8,9 | tCK(AVG)         | Reserved |      | ns |

|                        |                   |          |                       |        |     |
|------------------------|-------------------|----------|-----------------------|--------|-----|
| CL=9                   | CWL =5            | tCK(AVG) | Reserved              |        | ns  |
|                        | CWL=6             | tCK(AVG) | Reserved              |        | ns  |
|                        | CWL=7             | tCK(AVG) | 1.5                   | <1.875 | ns  |
|                        | CWL=8,9           | tCK(AVG) | Reserved              |        | ns  |
| CL=10                  | CWL =5            | tCK(AVG) | Reserved              |        | ns  |
|                        | CWL=6             | tCK(AVG) | Reserved              |        | ns  |
|                        | CWL=7             | tCK(AVG) | 1.5                   | <1.875 | ns  |
|                        | CWL=8,9           | tCK(AVG) | Reserved              |        | ns  |
| CL=11                  | CWL =5            | tCK(AVG) | Reserved              |        | ns  |
|                        | CWL=6             | tCK(AVG) | Reserved              |        | ns  |
|                        | CWL=7             | tCK(AVG) | Reserved              |        | ns  |
|                        | CWL=8             | tCK(AVG) | 1.25                  | <1.5   | ns  |
|                        | CWL=9             | tCK(AVG) | Reserved              |        | ns  |
| CL=12                  | CWL=5,6,<br>7,8,9 | tCK(AVG) | Reserved              |        | ns  |
| CL=13                  | CWL=5,6,<br>7,8   | tCK(AVG) | Reserved              |        | ns  |
|                        | CWL =9            | tCK(AVG) | 1.07                  | <1.25  | ns  |
| Supported CL Settings  |                   |          | 5,6,7,8,9,10,11,12,13 |        | nCK |
| Supported CWL Settings |                   |          | 5,6,7,8,9             |        | nCK |

## 9. ELECTRICAL CHARACTERISTICS & AC TIMING

### 9.1 Timing Parameter by Speed Bin (DDR3-800, DDR3-1066)

| Parameter  | Symbol                      | DDR3/DDR3L-800   |         | DDR3/DDR3L-1066 |         | Units    | Notes   |
|--|-----------------------------|--|---------|-----------------|---------|----------|---------|
|  |                             | Min.   | Max.    | Min.            | Max.    |          |         |
| <b>Clock Timing</b>  |                             |  |         |                 |         |          |         |
| Minimum Clock Cycle Time (DLL off mode)                              | tCK(DLL_OFF)                | 5  | -       | 5               | -       | ns       | 6       |
| Average Clock Period   | tCK(avg)                    | Refer to Standard Speed Bins   |         |                 |         | ps       |         |
| Average high pulse width   | tCH(avg)                    | 0.47   | 0.53    | 0.47            | 0.53    | tCK(avg) |         |
| Average low pulse width  | tCL(avg)                    | 0.47   | 0.53    | 0.47            | 0.53    | tCK(avg) |         |
| Absolute Clock Period  | tCK(abs)                    | Min.: tCK(avg)min + tJIT(per)min<br>Max.: tCK(avg)max + tJIT(per)max                             |         |                 |         | ps       |         |
| Absolute clock HIGH pulse width                                      | tCH(abs)                    | 0.43   | -       | 0.43            | -       | tCK(avg) | 25      |
| Absolute clock LOW pulse width                                       | tCL(abs)                    | 0.43   | -       | 0.43            | -       | tCK(avg) | 26      |
| Clock Period Jitter  | tJIT(per)                   | -100   | 100     | -90             | 90      | ps       |         |
| Clock Period Jitter during DLL locking period                        | tJIT(per, lck)              | -90  | 90      | -80             | 80      | ps       |         |
| Cycle to Cycle Period Jitter   | tJIT(cc)                    | 200  |         | 180             |         | ps       |         |
| Cycle to Cycle Period Jitter during DLL locking period               | tJIT(cc, lck)               | 180  |         | 160             |         | ps       |         |
| Duty Cycle Jitter  | tJIT(duty)                  | -  | -       | -               | -       | ps       |         |
| Cumulative error across 2 cycles                                     | tERR(2per)                  | -147   | 147     | -132            | 132     | ps       |         |
| Cumulative error across 3 cycles                                     | tERR(3per)                  | -175   | 175     | -157            | 157     | ps       |         |
| Cumulative error across 4 cycles                                     | tERR(4per)                  | -194   | 194     | -175            | 175     | ps       |         |
| Cumulative error across 5 cycles                                     | tERR(5per)                  | -209   | 209     | -188            | 188     | ps       |         |
| Cumulative error across 6 cycles                                     | tERR(6per)                  | -222   | 222     | -200            | 200     | ps       |         |
| Cumulative error across 7 cycles                                     | tERR(7per)                  | -232   | 232     | -209            | 209     | ps       |         |
| Cumulative error across 8 cycles                                     | tERR(8per)                  | -241   | 241     | -217            | 217     | ps       |         |
| Cumulative error across 9 cycles                                     | tERR(9per)                  | -249   | 249     | -224            | 224     | ps       |         |
| Cumulative error across 10 cycles                                    | tERR(10per)                 | -257   | 257     | -231            | 231     | ps       |         |
| Cumulative error across 11 cycles                                    | tERR(11per)                 | -263   | 263     | -237            | 237     | ps       |         |
| Cumulative error across 12 cycles                                    | tERR(12per)                 | -269   | 269     | -242            | 242     | ps       |         |
| Cumulative error across n = 13, 14 . . . 49, 50 cycles               | tERR(nper)                  | tERR(nper)min = (1 + 0.68ln(n)) * tJIT(per)min<br>tERR(nper)max = (1 + 0.68ln(n)) * tJIT(per)max |         |                 |         | ps       | 24      |
| <b>Data Timing</b>   |                             |  |         |                 |         |          |         |
| DQS, DQS# to DQ skew, per group, per access                          | tDQSQ                       | -  | 200     | -               | 150     | ps       | 13      |
| DQ output hold time from DQS, DQS#                                   | tQH                         | 0.38   | -       | 0.38            | -       | tCK(avg) | 13,g    |
| DQ low-impedance time from CK, CK#                                   | tLZ(DQ)                     | -800   | 400     | -600            | 300     | ps       | 13,14,f |
| DQ high impedance time from CK, CK#                                  | tHZ(DQ)                     | -  | 400     | -               | 300     | ps       | 13,14,f |
| Data setup time to DQS, DQS# referenced to Vih(ac) / Vil(ac) levels  | tDS(base)<br>AC175 or AC160 | See table for Data Setup and Hold  |         |                 |         | ps       | d,17    |
| Data setup time to DQS, DQS# referenced to Vih(ac) / Vil(ac) levels  | tDS(base)<br>AC150 or AC135 |  |         |                 |         | ps       | d,17    |
| Data hold time from DQS, DQS# referenced to Vih(dc) / Vil(dc) levels | tDH(base)<br>DC100 or DC90  |  |         |                 |         | ps       | d,17    |
| DQ and DM Input pulse width for each input                           | tDIPW                       | 600  | -       | 490             | -       | ps       | 28      |
| <b>Data Strobe Timing</b>  |                             |  |         |                 |         |          |         |
| DQS,DQS# differential READ Preamble                                  | tRPRE                       | 0.9  | Note 19 | 0.9             | Note 19 | tCK(avg) | 13,19,g |
| DQS, DQS# differential READ Postamble                                | tRPST                       | 0.3  | Note 11 | 0.3             | Note 11 | tCK(avg) | 11,13,g |

| Parameter   | Symbol                      | DDR3/DDR3L-800                       |      | DDR3/DDR3L-1066      |      | Units    | Notes   |         |
|---|-----------------------------|--------------------------------------|------|----------------------|------|----------|---------|---------|
|   |                             | Min.                                 | Max. | Min.                 | Max. |          |         |         |
| DQS, DQS# differential output high time   | tQSH                        | 0.38                                 | -    | 0.38                 | -    | tCK(avg) | 13,g    |         |
| DQS, DQS# differential output low time  | tQSL                        | 0.38                                 | -    | 0.38                 | -    | tCK(avg) | 13,g    |         |
| DQS, DQS# differential WRITE Preamble   | tWPRE                       | 0.9                                  | -    | 0.9                  | -    | tCK(avg) |         |         |
| DQS, DQS# differential WRITE Postamble  | tWPST                       | 0.3                                  | -    | 0.3                  | -    | tCK(avg) |         |         |
| DQS, DQS# rising edge output access time from rising CK, CK#                      | tDQSCK                      | -400                                 | 400  | -300                 | 300  | ps       | 13,f    |         |
| DQS and DQS# low-impedance time (Referenced from RL - 1)                          | tLZ(DQS)                    | -800                                 | 400  | -600                 | 300  | ps       | 13,14,f |         |
| DQS and DQS# high-impedance time (Referenced from RL + BL/2)                      | tHZ(DQS)                    | -                                    | 400  | -                    | 300  | ps       | 13,14,f |         |
| DQS, DQS# differential input low pulse width                                      | tDQSL                       | 0.45                                 | 0.55 | 0.45                 | 0.55 | tCK(avg) | 29,31   |         |
| DQS, DQS# differential input high pulse width                                     | tDQSH                       | 0.45                                 | 0.55 | 0.45                 | 0.55 | tCK(avg) | 30,31   |         |
| DQS, DQS# rising edge to CK, CK# rising edge                                      | tDQSS                       | -0.25                                | 0.25 | -0.25                | 0.25 | tCK(avg) | c       |         |
| DQS, DQS# falling edge setup time to CK, CK# rising edge                          | tDSS                        | 0.2                                  | -    | 0.2                  | -    | tCK(avg) | c,32    |         |
| DQS, DQS# falling edge hold time from CK, CK# rising edge                         | tDSH                        | 0.2                                  | -    | 0.2                  | -    | tCK(avg) | c,32    |         |
| <b>Command and Address Timing</b>   |                             |                                      |      |                      |      |          |         |         |
| DLL locking time  | tDLLK                       | 512                                  | -    | 512                  | -    | nCK      |         |         |
| Internal READ Command to PRECHARGE Command delay                                  | tRTP                        | tRTPmin.: max(4nCK, 7.5ns)           |      |                      |      |          | e       |         |
|   |                             | tRTPmax.: -                          |      |                      |      |          |         |         |
| Delay from start of internal write transaction to internal read command           | tWTR                        | tWTRmin.: max(4nCK, 7.5ns)           |      |                      |      |          | e,18    |         |
|   |                             | tWTRmax.:                            |      |                      |      |          |         |         |
| WRITE recovery time   | tWR                         | 15                                   | -    | 15                   | -    | ns       | e,18    |         |
| Mode Register Set command cycle time  | tMRD                        | 4                                    | -    | 4                    | -    | nCK      |         |         |
| Mode Register Set command update delay  | tMOD                        | tMODmin.: max(12nCK, 15ns)           |      |                      |      |          |         |         |
|   |                             | tMODmax.:                            |      |                      |      |          |         |         |
| ACT to internal read or write delay time  | tRCD                        | Standard Speed Bins                  |      |                      |      |          | e       |         |
| PRE command period  | tRP                         | Standard Speed Bins                  |      |                      |      |          | e       |         |
| ACT to ACT or REF command period  | tRC                         | Standard Speed Bins                  |      |                      |      |          | e       |         |
| CAS# to CAS# command delay  | tCCD                        | 4                                    | -    | 4                    | -    | nCK      |         |         |
| Auto precharge write recovery + precharge time                                    | tDAL(min)                   | WR + roundup(tRP / tCK(avg))         |      |                      |      |          | nCK     |         |
| Multi-Purpose Register Recovery Time  | tMPRR                       | 1                                    | -    | 1                    | -    | nCK      | 22      |         |
| ACTIVE to PRECHARGE command period  | tRAS                        | Standard Speed Bins                  |      |                      |      |          | e       |         |
| ACTIVE to ACTIVE command period for 1KB page size                                 | tRRD                        | max(4nCK, 10ns)                      | -    | max(4nCK, 7.5ns)     | -    |          | e       |         |
| ACTIVE to ACTIVE command period for 2KB page size                                 | tRRD                        | tRRDmin.: max(4nCK, 10ns)            |      |                      |      |          | e       |         |
|   |                             | tRRDmax.:                            |      |                      |      |          |         |         |
| Four activate window for 1KB page size  | tFAW                        | 40                                   | -    | 37.5                 | -    | ns       | e       |         |
| Four activate window for 2KB page size  | tFAW                        | 50                                   | -    | 50                   | -    | ns       | e       |         |
| Command and Address setup time to CK, CK# referenced to Vih(ac) / Vil(ac) levels  | tIS(base)<br>AC175 or AC160 | See table for ADD/CMD setup and hold |      |                      |      |          | ps      | b,16    |
| Command and Address setup time to CK, CK# referenced to Vih(ac) / Vil(ac) levels  | tIS(base)<br>AC150 or AC135 |                                      |      |                      |      |          | ps      | b,16,27 |
| Command and Address hold time from CK, CK# referenced to Vih(dc) / Vil(dc) levels | tIH(base)<br>DC100 or DC90  |                                      |      |                      |      |          | ps      | b,16    |
| Control and Address Input pulse width for each input                              | tIPW                        | 900                                  | -    | 780                  | -    | ps       | 28      |         |
| <b>Calibration Timing</b>   |                             |                                      |      |                      |      |          |         |         |
| Power-up and RESET calibration time   | tZQinit                     | max (512 nCK, 640ns)                 | -    | max (512 nCK, 640ns) | -    |          |         |         |



| Parameter  | Symbol   | DDR3/DDR3L-800                         |      | DDR3/DDR3L-1066             |      | Units | Notes |
|--|----------|--|------|-----------------------------|------|-------|-------|
|  |          | Min.                                   | Max. | Min.                        | Max. |       |       |
| Normal operation Full calibration time   | tZQoper  | max (256 nCK, 320ns)                   | -    | max (256 nCK, 320ns)        | -    |       |       |
| Normal operation Short calibration time  | tZQCS    | max (64 nCK, 80ns)                     | -    | max (64 nCK, 80ns)          | -    |       | 23    |
| <b>Reset Timing</b>  |          |  |      |                             |      |       |       |
| Exit Reset from CKE HIGH to a valid command  | tXPR     | tXPRmin.: max(5nCK, tRFC(min) + 10ns)  |      |                             |      |       |       |
|  |          | tXPRmax.: -                            |      |                             |      |       |       |
| <b>Self Refresh Timings</b>  |          |  |      |                             |      |       |       |
| Exit Self Refresh to commands not requiring a locked DLL   | tXS      | tXSmin.: max(5nCK, tRFC(min) + 10ns)   |      |                             |      |       |       |
|  |          | tXSmax.: -                             |      |                             |      |       |       |
| Exit Self Refresh to commands requiring a locked DLL   | tXSDLL   | tXSDLLmin.: tDLLK(min)                 |      |                             |      | nCK   | 2     |
|  |          | tXSDLLmax.: -                          |      |                             |      |       |       |
| Minimum CKE low width for Self Refresh entry to exit timing  | tCKESR   | tCKESRmin.: tCKE(min) + 1 nCK          |      |                             |      |       |       |
|  |          | tCKESRmax.: -                          |      |                             |      |       |       |
| Valid Clock Requirement after Self Refresh Entry (SRE) or Power-Down Entry (PDE)   | tCKSRE   | tCKSREmin.: max(5 nCK, 10 ns)          |      |                             |      |       |       |
|  |          | tCKSREmax.: -                          |      |                             |      |       |       |
| Valid Clock Requirement before Self Refresh Exit (SRX) or Power-Down Exit (PDX) or Reset Exit                                      | tCKSRX   | tCKSRXmin.: max(5 nCK, 10 ns)          |      |                             |      |       |       |
|  |          | tCKSRXmax.: -                          |      |                             |      |       |       |
| <b>Power Down Timings</b>  |          |  |      |                             |      |       |       |
| Exit Power Down with DLL on to any valid command; Exit Precharge Power Down with DLL frozen to commands not requiring a locked DLL | tXP      | tXPmin.: max(3nCK, 7.5ns)              |      |                             |      |       |       |
|  |          | tXPmax.: -                             |      |                             |      |       |       |
| Exit Precharge Power Down with DLL frozen to commands requiring a locked DLL   | tXPDLL   | tXPDLLmin.: max(10nCK, 24ns)           |      |                             |      |       |       |
|  |          | tXPDLLmax.: -                          |      |                             |      |       |       |
| CKE minimum pulse width  | tCKE     | tCKEmin.: max(3nCK 7.5ns)              |      | tCKEmin.: max(3nCK 5.625ns) |      |       |       |
|  |          | tCKEmax.: -                            |      | tCKEmax.: -                 |      |       |       |
| Command pass disable delay   | tCPDED   | tCPDEDmin.: 1                          |      |                             |      | nCK   |       |
|  |          | tCPDEDmax.: -                          |      |                             |      |       |       |
| Power Down Entry to Exit Timing  | tPD      | tPDmin.: tCKE(min)                     |      |                             |      |       | 15    |
|  |          | tPDmax.: 9*tREFI                       |      |                             |      |       |       |
| Timing of ACT command to Power Down entry  | tACTPDEN | tACTPDENmin.: 1                        |      |                             |      | nCK   | 20    |
|  |          | tACTPDENmax.: -                        |      |                             |      |       |       |
| Timing of PRE or PREA command to Power Down entry  | tPRPDEN  | tPRPDENmin.: 1                         |      |                             |      | nCK   | 20    |
|  |          | tPRPDENmax.: -                         |      |                             |      |       |       |
| Parameter  | Symbol   | DDR3-800                               |      | DDR3-1066                   |      | Units | Notes |
|  |          | Min.                                   | Max. | Min.                        | Max. |       |       |
| Timing of RD/RDA command to Power Down entry   | tRDPDEN  | tRDPDENmin.: RL+4+1                    |      |                             |      | nCK   |       |
|  |          | tRDPDENmax.: -                         |      |                             |      |       |       |
| Timing of WR command to Power Down entry (BL8OTF, BL8MRS, BC4OTF)  | tWRPDEN  | tWRPDENmin.: WL + 4 + (tWR / tCK(avg)) |      |                             |      | nCK   | 9     |
|  |          | tWRPDENmax.: -                         |      |                             |      |       |       |
| Timing of WRA command to Power Down entry (BL8OTF, BL8MRS, BC4OTF)   | tWRAPDEN | tWRAPDENmin.: WL+4+WR+1                |      |                             |      | nCK   | 10    |
|  |          | tWRAPDENmax.: -                        |      |                             |      |       |       |
| Timing of WR command to Power Down entry (BC4MRS)  | tWRPDEN  | tWRPDENmin.: WL + 2 + (tWR / tCK(avg)) |      |                             |      | nCK   | 9     |
|  |          | tWRPDENmax.: -                         |      |                             |      |       |       |
| Timing of WRA command to Power Down entry (BC4MRS)   | tWRAPDEN | tWRAPDENmin.: WL + 2 +WR + 1           |      |                             |      | nCK   | 10    |
|  |          | tWRAPDENmax.: -                        |      |                             |      |       |       |
| Timing of REF command to Power Down entry  | tREFPDEN | tREFPDENmin.: 1                        |      |                             |      | nCK   | 20,21 |
|  |          | tREFPDENmax.: -                        |      |                             |      |       |       |

| Parameter   | Symbol   | DDR3/DDR3L-800          |      | DDR3/DDR3L-1066 |      | Units    | Notes |
|---|----------|-------------------------|------|-----------------|------|----------|-------|
|   |          | Min.                    | Max. | Min.            | Max. |          |       |
| Timing of MRS command to Power Down entry   | tMRSPDEN | tMRSPDENmin.: tMOD(min) |      |                 |      |          |       |
|   |          | tMRSPDENmax.: -         |      |                 |      |          |       |
| <b>ODT Timings</b>  |          |                         |      |                 |      |          |       |
| ODT high time without write command or with write command and BC4                   | ODTH4    | ODTH4min.: 4            |      |                 |      | nCK      |       |
|   |          | ODTH4max.: -            |      |                 |      |          |       |
| ODT high time with Write command and BL8  | ODTH8    | ODTH8min.: 6            |      |                 |      | nCK      |       |
|   |          | ODTH8max.: -            |      |                 |      |          |       |
| Asynchronous RTT turn-on delay (Power-Down with DLL frozen)                         | tAONPD   | 2                       | 8.5  | 2               | 8.5  | ns       |       |
| Asynchronous RTT turn-off delay (Power-Down with DLL frozen)                        | tAOFPD   | 2                       | 8.5  | 2               | 8.5  | ns       |       |
| RTT turn-on   | tAON     | -400                    | 400  | -300            | 300  | ps       | 7,f   |
| RTT_Nom and RTT_WR turn-off time from ODTLoff reference                             | tAOF     | 0.3                     | 0.7  | 0.3             | 0.7  | tCK(avg) | 8,f   |
| RTT dynamic change skew   | tADC     | 0.3                     | 0.7  | 0.3             | 0.7  | tCK(avg) | f     |
| <b>Write Leveling Timings</b>   |          |                         |      |                 |      |          |       |
| First DQS/DQS# rising edge after write leveling mode is programmed                  | tWLMRD   | 40                      | -    | 40              | -    | nCK      | 3     |
| DQS/DQS# delay after write leveling mode is programmed                              | tWLDQSEN | 25                      | -    | 25              | -    | nCK      | 3     |
| Write leveling setup time from rising CK, CK# crossing to rising DQS, DQS# crossing | tWLS     | 325                     | -    | 245             | -    | ps       |       |
| Write leveling hold time from rising DQS, DQS# crossing to rising CK, CK# crossing  | tWLH     | 325                     | -    | 245             | -    | ps       |       |
| Write leveling output delay   | tWLO     | 0                       | 9    | 0               | 9    | ns       |       |
| Write leveling output error   | tWLOE    | 0                       | 2    | 0               | 2    | ns       |       |

9.2 Timing Parameter by Speed Bin (DDR3-1333, DDR3-1600)

| Parameter  | Symbol                  | DDR3/DDR3L-1333  |         | DDR3/DDR3L-1600 |         | Units    | Notes   |
|--|-------------------------|--|---------|-----------------|---------|----------|---------|
|  |                         | Min.   | Max.    | Min.            | Max.    |          |         |
| <b>Clock Timing</b>  |                         |  |         |                 |         |          |         |
| Minimum Clock Cycle Time (DLL off mode)                              | tCK(DLL_OFF)            | 5  | -       | 5               | -       | ns       | 6       |
| Average Clock Period   | tCK(avg)                | Refer to Standard Speed Bins   |         |                 |         | ps       |         |
| Average high pulse width   | tCH(avg)                | 0.47   | 0.53    | 0.47            | 0.53    | tCK(avg) |         |
| Average low pulse width  | tCL(avg)                | 0.47   | 0.53    | 0.47            | 0.53    | tCK(avg) |         |
| Absolute Clock Period  | tCK(abs)                | Min.: tCK(avg)min + tJIT(per)min<br>Max.: tCK(avg)max + tJIT(per)max                             |         |                 |         | ps       |         |
| Absolute clock HIGH pulse width                                      | tCH(abs)                | 0.43   | -       | 0.43            | -       | tCK(avg) | 25      |
| Absolute clock LOW pulse width                                       | tCL(abs)                | 0.43   | -       | 0.43            | -       | tCK(avg) | 26      |
| Clock Period Jitter  | tJIT(per)               | -80  | 80      | -70             | 70      | ps       |         |
| Clock Period Jitter during DLL locking period                        | tJIT(per, lck)          | -70  | 70      | -60             | 60      | ps       |         |
| Cycle to Cycle Period Jitter   | tJIT(cc)                | 160  |         | 140             |         | ps       |         |
| Cycle to Cycle Period Jitter during DLL locking period               | tJIT(cc, lck)           | 140  |         | 120             |         | ps       |         |
| Duty Cycle Jitter  | tJIT(duty)              | -  | -       | -               | -       | ps       |         |
| Cumulative error across 2 cycles                                     | tERR(2per)              | -118   | 118     | -103            | 103     | ps       |         |
| Cumulative error across 3 cycles                                     | tERR(3per)              | -140   | 140     | -122            | 122     | ps       |         |
| Cumulative error across 4 cycles                                     | tERR(4per)              | -155   | 155     | -136            | 136     | ps       |         |
| Cumulative error across 5 cycles                                     | tERR(5per)              | -168   | 168     | -147            | 147     | ps       |         |
| Cumulative error across 6 cycles                                     | tERR(6per)              | -177   | 177     | -155            | 155     | ps       |         |
| Cumulative error across 7 cycles                                     | tERR(7per)              | -186   | 186     | -163            | 163     | ps       |         |
| Cumulative error across 8 cycles                                     | tERR(8per)              | -193   | 193     | -169            | 169     | ps       |         |
| Cumulative error across 9 cycles                                     | tERR(9per)              | -200   | 200     | -175            | 175     | ps       |         |
| Cumulative error across 10 cycles                                    | tERR(10per)             | -205   | 205     | -180            | 180     | ps       |         |
| Cumulative error across 11 cycles                                    | tERR(11per)             | -210   | 210     | -184            | 184     | ps       |         |
| Cumulative error across 12 cycles                                    | tERR(12per)             | -215   | 215     | -188            | 188     | ps       |         |
| Cumulative error across n = 13, 14 . . . 49, 50 cycles               | tERR(nper)              | tERR(nper)min = (1 + 0.68ln(n)) * tJIT(per)min<br>tERR(nper)max = (1 + 0.68ln(n)) * tJIT(per)max |         |                 |         | ps       | 24      |
| <b>Data Timing</b>   |                         |  |         |                 |         |          |         |
| DQS, DQS# to DQ skew, per group, per access                          | tDQSQ                   | -  | 125     | -               | 100     | ps       | 13      |
| DQ output hold time from DQS, DQS#                                   | tQH                     | 0.38   | -       | 0.38            | -       | tCK(avg) | 13,g    |
| DQ low-impedance time from CK, CK#                                   | tLZ(DQ)                 | -500   | 250     | -450            | 225     | ps       | 13,14,f |
| DQ high impedance time from CK, CK#                                  | tHZ(DQ)                 | -  | 250     | -               | 225     | ps       | 13,14,f |
| Data setup time to DQS, DQS# referenced to Vih(ac) / Vil(ac) levels  | tDS(base) AC150         | See table for Data Setup and Hold  |         |                 |         | ps       | d,17    |
| Data setup time to DQS, DQS# referenced to Vih(ac) / Vil(ac) levels  | tDS(base) AC135         |  |         |                 |         | ps       | d,17    |
| Data hold time from DQS, DQS# referenced to Vih(dc) / Vil(dc) levels | tDH(base) DC100 or DC90 |  |         |                 |         | ps       | d,17    |
| DQ and DM Input pulse width for each input                           | tDIPW                   | 400  | -       | 360             | -       | ps       | 28      |
| <b>Data Strobe Timing</b>  |                         |  |         |                 |         |          |         |
| DQS,DQS# differential READ Preamble                                  | tRPRE                   | 0.9  | Note 19 | 0.9             | Note 19 | tCK(avg) | 13,19,g |
| DQS, DQS# differential READ Postamble                                | tRPST                   | 0.3  | Note 11 | 0.3             | Note 11 | tCK(avg) | 11,13,g |
| DQS, DQS# differential output high time                              | tQSH                    | 0.4  | -       | 0.4             | -       | tCK(avg) | 13,g    |
| DQS, DQS# differential output low time                               | tQSL                    | 0.4  | -       | 0.4             | -       | tCK(avg) | 13,g    |
| DQS, DQS# differential WRITE Preamble                                | tWPRE                   | 0.9  | -       | 0.9             | -       | tCK(avg) |         |
| DQS, DQS# differential WRITE Postamble                               | tWPST                   | 0.3  | -       | 0.3             | -       | tCK(avg) |         |

| Parameter   | Symbol                      | DDR3/DDR3L-1333                       |      | DDR3/DDR3L-1600      |      | Units    | Notes   |
|---|-----------------------------|---------------------------------------|------|----------------------|------|----------|---------|
|   |                             | Min.                                  | Max. | Min.                 | Max. |          |         |
| DQS, DQS# rising edge output access time from rising CK, CK#                      | tDQCK                       | -255                                  | 255  | -225                 | 225  | ps       | 13,f    |
| DQS and DQS# low-impedance time (Referenced from RL - 1)                          | tLZ(DQS)                    | -500                                  | 250  | -450                 | 225  | ps       | 13,14,f |
| DQS and DQS# high-impedance time (Referenced from RL + BL/2)                      | tHZ(DQS)                    | -                                     | 250  | -                    | 225  | ps       | 13,14,f |
| DQS, DQS# differential input low pulse width                                      | tDQSL                       | 0.45                                  | 0.55 | 0.45                 | 0.55 | tCK(avg) | 29,31   |
| DQS, DQS# differential input high pulse width                                     | tDQSH                       | 0.45                                  | 0.55 | 0.45                 | 0.55 | tCK(avg) | 30,31   |
| DQS, DQS# rising edge to CK, CK# rising edge                                      | tDQSS                       | -0.25                                 | 0.25 | -0.27                | 0.27 | tCK(avg) | c       |
| DQS, DQS# falling edge setup time to CK, CK# rising edge                          | tDSS                        | 0.2                                   | -    | 0.18                 | -    | tCK(avg) | c,32    |
| DQS, DQS# falling edge hold time from CK, CK# rising edge                         | tDSH                        | 0.2                                   | -    | 0.18                 | -    | tCK(avg) | c,32    |
| <b>Command and Address Timing</b>   |                             |                                       |      |                      |      |          |         |
| DLL locking time  | tDLLK                       | 512                                   | -    | 512                  | -    | nCK      |         |
| Internal READ Command to PRECHARGE Command delay                                  | tRTP                        | tRTPmin.: max(4nCK, 7.5ns)            |      |                      |      |          |         |
|   |                             | tRTPmax.: -                           |      |                      |      |          |         |
| Delay from start of internal write transaction to internal read command           | tWTR                        | tWTRmin.: max(4nCK, 7.5ns)            |      |                      |      |          |         |
|   |                             | tWTRmax.: -                           |      |                      |      |          |         |
| WRITE recovery time   | tWR                         | 15                                    | -    | 15                   | -    | ns       | e,18    |
| Mode Register Set command cycle time  | tMRD                        | 4                                     | -    | 4                    | -    | nCK      |         |
| Mode Register Set command update delay  | tMOD                        | tMODmin.: max(12nCK, 15ns)            |      |                      |      |          |         |
|   |                             | tMODmax.: -                           |      |                      |      |          |         |
| ACT to internal read or write delay time  | tRCD                        | Standard Speed Bins                   |      |                      |      |          |         |
| PRE command period  | tRP                         | Standard Speed Bins                   |      |                      |      |          |         |
| ACT to ACT or REF command period  | tRC                         | Standard Speed Bins                   |      |                      |      |          |         |
| CAS# to CAS# command delay  | tCCD                        | 4                                     | -    | 4                    | -    | nCK      |         |
| Auto precharge write recovery + precharge time                                    | tDAL(min)                   | WR + roundup(tRP / tCK(avg))          |      |                      |      | nCK      |         |
| Multi-Purpose Register Recovery Time  | tMPRR                       | 1                                     | -    | 1                    | -    | nCK      | 22      |
| ACTIVE to PRECHARGE command period  | tRAS                        | Standard Speed Bins                   |      |                      |      |          |         |
| ACTIVE to ACTIVE command period for 1KB page size                                 | tRRD                        | max(4nCK, 6ns)                        | -    | max(4nCK, 6ns)       | -    |          | e       |
| ACTIVE to ACTIVE command period for 2KB page size                                 | tRRD                        | tRRDmin.: max(4nCK, 7.5ns)            |      |                      |      |          |         |
|   |                             | tRRDmax.: -                           |      |                      |      |          |         |
| Four activate window for 1KB page size  | tFAW                        | 30                                    | -    | 30                   | -    | ns       | e       |
| Four activate window for 2KB page size  | tFAW                        | 45                                    | -    | 40                   | -    | ns       | e       |
| Command and Address setup time to CK, CK# referenced to Vih(ac) / Vil(ac) levels  | tIS(base)<br>AC175 or AC160 | See table for ADD/CMD Setup and Hold  |      |                      |      | ps       | b,16    |
| Command and Address setup time to CK, CK# referenced to Vih(ac) / Vil(ac) levels  | tIS(base)<br>AC150 or AC135 |                                       |      |                      |      | ps       | b,16,27 |
| Command and Address hold time from CK, CK# referenced to Vih(dc) / Vil(dc) levels | tIH(base)<br>DC100 or DC90  |                                       |      |                      |      | ps       | b,16    |
| Control and Address Input pulse width for each input                              | tIPW                        | 620                                   | -    | 560                  | -    | ps       | 28      |
| <b>Calibration Timing</b>   |                             |                                       |      |                      |      |          |         |
| Power-up and RESET calibration time   | tZQinit                     | max (512 nCK, 640ns)                  | -    | max (512 nCK, 640ns) | -    |          |         |
| Normal operation Full calibration time  | tZQoper                     | max (256 nCK, 320ns)                  | -    | max (256 nCK, 320ns) | -    |          |         |
| Normal operation Short calibration time   | tZQCS                       | max (64 nCK, 80ns)                    | -    | max (64 nCK, 80ns)   | -    |          | 23      |
| <b>Reset Timing</b>   |                             |                                       |      |                      |      |          |         |
| Exit Reset from CKE HIGH to a valid command                                       | tXPR                        | tXPRmin.: max(5nCK, tRFC(min) + 10ns) |      |                      |      |          |         |
|   |                             | tXPRmax.: -                           |      |                      |      |          |         |

| Parameter  | Symbol   | DDR3/DDR3L-1333                        |      | DDR3/DDR3L-1600            |      | Units | Notes |
|--|----------|--|------|----------------------------|------|-------|-------|
|  |          | Min.                                   | Max. | Min.                       | Max. |       |       |
| <b>Self Refresh Timings</b>  |          |  |      |                            |      |       |       |
| Exit Self Refresh to commands not requiring a locked DLL   | tXS      | tXSmin.: max(5nCK, tRFC(min) + 10ns)   |      |                            |      |       |       |
|  |          | tXSmax.: -                             |      |                            |      |       |       |
| Exit Self Refresh to commands requiring a locked DLL   | tXSDLL   | tXSDLLmin.: tDLLK(min)                 |      |                            |      | nCK   | 2     |
|  |          | tXSDLLmax.: -                          |      |                            |      |       |       |
| Minimum CKE low width for Self Refresh entry to exit timing  | tCKESR   | tCKESRmin.: tCKE(min) + 1 nCK          |      |                            |      |       |       |
|  |          | tCKESRmax.: -                          |      |                            |      |       |       |
| Valid Clock Requirement after Self Refresh Entry (SRE) or Power-Down Entry (PDE)   | tCKSRE   | tCKSREmin.: max(5 nCK, 10 ns)          |      |                            |      |       |       |
|  |          | tCKSREmax.: -                          |      |                            |      |       |       |
| Valid Clock Requirement before Self Refresh Exit (SRX) or Power-Down Exit (PDX) or Reset Exit                                      | tCKSRX   | tCKSRXmin.: max(5 nCK, 10 ns)          |      |                            |      |       |       |
|  |          | tCKSRXmax.: -                          |      |                            |      |       |       |
| <b>Power Down Timings</b>  |          |  |      |                            |      |       |       |
| Exit Power Down with DLL on to any valid command; Exit Precharge Power Down with DLL frozen to commands not requiring a locked DLL | tXP      | tXPmin.: max(3nCK, 6ns)                |      |                            |      |       |       |
|  |          | tXPmax.: -                             |      |                            |      |       |       |
| Exit Precharge Power Down with DLL frozen to commands requiring a locked DLL   | tXPDLL   | tXPDLLmin.: max(10nCK, 24ns)           |      |                            |      |       |       |
|  |          | tXPDLLmax.: -                          |      |                            |      |       |       |
| CKE minimum pulse width  | tCKE     | tCKEmin.: max(3nCK<br>5.625ns)         |      | tCKEmin.: max(3nCK<br>5ns) |      |       |       |
|  |          | tCKEmin.: -                            |      | tCKEmin.: -                |      |       |       |
| Command pass disable delay   | tCPDED   | tCPDEDmin.: 1                          |      |                            |      | nCK   |       |
|  |          | tCPDEDmax.: -                          |      |                            |      |       |       |
| Power Down Entry to Exit Timing  | tPD      | tPDmin.: tCKE(min)                     |      |                            |      |       | 15    |
|  |          | tPDmax.: 9*tREFI                       |      |                            |      |       |       |
| Timing of ACT command to Power Down entry  | tACTPDEN | tACTPDENmin.: 1                        |      |                            |      | nCK   | 20    |
|  |          | tACTPDENmax.: -                        |      |                            |      |       |       |
| Timing of PRE or PREA command to Power Down entry  | tPRPDEN  | tPRPDENmin.: 1                         |      |                            |      | nCK   | 20    |
|  |          | tPRPDENmax.: -                         |      |                            |      |       |       |
| Timing of RD/RDA command to Power Down entry   | tRDPDEN  | tRDPDENmin.: RL+4+1                    |      |                            |      | nCK   |       |
|  |          | tRDPDENmax.: -                         |      |                            |      |       |       |
| Timing of WR command to Power Down entry (BL8OTF, BL8MRS, BC4OTF)  | tWRPDEN  | tWRPDENmin.: WL + 4 + (tWR / tCK(avg)) |      |                            |      | nCK   | 9     |
|  |          | tWRPDENmax.: -                         |      |                            |      |       |       |
| Timing of WRA command to Power Down entry (BL8OTF, BL8MRS, BC4OTF)   | tWRAPDEN | tWRAPDENmin.: WL+4+WR+1                |      |                            |      | nCK   | 10    |
|  |          | tWRAPDENmax.: -                        |      |                            |      |       |       |
| Timing of WR command to Power Down entry (BC4MRS)  | tWRPDEN  | tWRPDENmin.: WL + 2 + (tWR / tCK(avg)) |      |                            |      | nCK   | 9     |
|  |          | tWRPDENmax.: -                         |      |                            |      |       |       |
| Timing of WRA command to Power Down entry (BC4MRS)   | tWRAPDEN | tWRAPDENmin.: WL + 2 + WR + 1          |      |                            |      | nCK   | 10    |
|  |          | tWRAPDENmax.: -                        |      |                            |      |       |       |
| Timing of REF command to Power Down entry  | tREFPDEN | tREFPDENmin.: 1                        |      |                            |      | nCK   | 20,21 |
|  |          | tREFPDENmax.: -                        |      |                            |      |       |       |
| Timing of MRS command to Power Down entry  | tMRSPDEN | tMRSPDENmin.: tMOD(min)                |      |                            |      |       |       |
|  |          | tMRSPDENmax.: -                        |      |                            |      |       |       |
| <b>ODT Timings</b>   |          |  |      |                            |      |       |       |
| ODT high time without write command or with write command and BC4  | ODTH4    | ODTH4min.: 4                           |      |                            |      | nCK   |       |
|  |          | ODTH4max.: -                           |      |                            |      |       |       |
| ODT high time with Write command and BL8   | ODTH8    | ODTH8min.: 6                           |      |                            |      | nCK   |       |
|  |          | ODTH8max.: -                           |      |                            |      |       |       |
| Asynchronous RTT turn-on delay (Power-Down with DLL frozen)  | tAONPD   | 2                                      | 8.5  | 2                          | 8.5  | ns    |       |
| Asynchronous RTT turn-off delay (Power-Down with DLL frozen)   | tAOFPD   | 2                                      | 8.5  | 2                          | 8.5  | ns    |       |
| RTT turn-on  | tAON     | -250                                   | 250  | -225                       | 225  | ps    | 7,f   |

| Parameter   | Symbol   | DDR3/DDR3L-1333 |      | DDR3/DDR3L-1600 |      | Units    | Notes |
|---|----------|-----------------|------|-----------------|------|----------|-------|
|   |          | Min.            | Max. | Min.            | Max. |          |       |
| RTT_Nom and RTT_WR turn-off time from ODTLoff reference                             | tAOF     | 0.3             | 0.7  | 0.3             | 0.7  | tCK(avg) | 8,f   |
| RTT dynamic change skew   | tADC     | 0.3             | 0.7  | 0.3             | 0.7  | tCK(avg) | f     |
| <b>Write Leveling Timings</b>   |          |                 |      |                 |      |          |       |
| First DQS/DQS# rising edge after write leveling mode is programmed                  | tWLMRD   | 40              | -    | 40              | -    | nCK      | 3     |
| DQS/DQS# delay after write leveling mode is programmed                              | tWLDQSEN | 25              | -    | 25              | -    | nCK      | 3     |
| Write leveling setup time from rising CK, CK# crossing to rising DQS, DQS# crossing | tWLS     | 195             | -    | 165             | -    | ps       |       |
| Write leveling hold time from rising DQS, DQS# crossing to rising CK, CK# crossing  | tWLH     | 195             | -    | 165             | -    | ps       |       |
| Write leveling output delay   | tWLO     | 0               | 9    | 0               | 7.5  | ns       |       |
| Write leveling output error   | tWLOE    | 0               | 2    | 0               | 2    | ns       |       |

### 9.3 Timing Parameter by Speed Bin (DDR3-1866, DDR3-2133)

| Parameter  | Symbol         | DDR3/DDR3L-1866  |      | DDR3-2133 |      | Units    | Notes   |
|--|----------------|--|------|-----------|------|----------|---------|
|  |                | Min.   | Max. | Min.      | Max. |          |         |
| <b>Clock Timing</b>                                    |                |  |      |           |      |          |         |
| Minimum Clock Cycle Time (DLL off mode)                | tCK(DLL_OFF)   | 5  | -    | 5         | -    | ns       | 6       |
| Average Clock Period                                   | tCK(avg)       | Refer to Standard Speed Bins   |      |           |      | ps       |         |
| Average high pulse width                               | tCH(avg)       | 0.47   | 0.53 | 0.47      | 0.53 | tCK(avg) |         |
| Average low pulse width                                | tCL(avg)       | 0.47   | 0.53 | 0.47      | 0.53 | tCK(avg) |         |
| Absolute Clock Period                                  | tCK(abs)       | Min.: tCK(avg)min + tJIT(per)min<br>Max.: tCK(avg)max + tJIT(per)max                             |      |           |      | ps       |         |
| Absolute clock HIGH pulse width                        | tCH(abs)       | 0.43   | -    | 0.43      | -    | tCK(avg) | 25      |
| Absolute clock LOW pulse width                         | tCL(abs)       | 0.43   | -    | 0.43      | -    | tCK(avg) | 26      |
| Clock Period Jitter                                    | tJIT(per)      | -60  | 60   | -50       | 50   | ps       |         |
| Clock Period Jitter during DLL locking period          | tJIT(per, lck) | -50  | 50   | -40       | 40   | ps       |         |
| Cycle to Cycle Period Jitter                           | tJIT(cc)       | 120  |      | 100       |      | ps       |         |
| Cycle to Cycle Period Jitter during DLL locking period | tJIT(cc, lck)  | 100  |      | 80        |      | ps       |         |
| Duty Cycle Jitter                                      | tJIT(duty)     | -  | -    | -         | -    | ps       |         |
| Cumulative error across 2 cycles                       | tERR(2per)     | -88  | 88   | -74       | 74   | ps       |         |
| Cumulative error across 3 cycles                       | tERR(3per)     | -105   | 105  | -87       | 87   | ps       |         |
| Cumulative error across 4 cycles                       | tERR(4per)     | -117   | 117  | -97       | 97   | ps       |         |
| Cumulative error across 5 cycles                       | tERR(5per)     | -126   | 126  | -105      | 105  | ps       |         |
| Cumulative error across 6 cycles                       | tERR(6per)     | -133   | 133  | -111      | 111  | ps       |         |
| Cumulative error across 7 cycles                       | tERR(7per)     | -139   | 139  | -116      | 116  | ps       |         |
| Cumulative error across 8 cycles                       | tERR(8per)     | -145   | 145  | -121      | 121  | ps       |         |
| Cumulative error across 9 cycles                       | tERR(9per)     | -150   | 150  | -125      | 125  | ps       |         |
| Cumulative error across 10 cycles                      | tERR(10per)    | -154   | 154  | -128      | 128  | ps       |         |
| Cumulative error across 11 cycles                      | tERR(11per)    | -158   | 158  | -132      | 132  | ps       |         |
| Cumulative error across 12 cycles                      | tERR(12per)    | -161   | 161  | -134      | 134  | ps       |         |
| Cumulative error across n = 13, 14 . . . 49, 50 cycles | tERR(nper)     | tERR(nper)min = (1 + 0.68ln(n)) * tJIT(per)min<br>tERR(nper)max = (1 + 0.68ln(n)) * tJIT(per)max |      |           |      | ps       |         |
| <b>Data Timing</b>                                     |                |  |      |           |      |          |         |
| DQS, DQS# to DQ skew, per group, per access            | tDQSQ          | -  | 85   | -         | 75   | ps       | 13      |
| DQ output hold time from DQS, DQS#                     | tQH            | 0.38   | -    | 0.38      | -    | tCK(avg) | 13,g    |
| DQ low-impedance time from CK, CK#                     | tLZ(DQ)        | -390   | 195  | -360      | 180  | ps       | 13,14,f |
| DQ high impedance time from CK, CK#                    | tHZ(DQ)        | -  | 195  | -         | 180  | ps       | 13,14,f |



| Parameter  | Symbol                     | DDR3/DDR3L-1866                           |         | DDR3/DDR3L-2133 |         | Units    | Notes   |
|--|----------------------------|---|---------|-----------------|---------|----------|---------|
|  |                            | Min.                                      | Max.    | Min.            | Max.    |          |         |
| Data setup time to DQS, DQS# referenced to Vih(ac) / Vil(ac) levels              | tDS(base)<br>AC135         | See table for Data Setup and Hold         |         |                 |         | ps       | d,17    |
| Data setup time to DQS, DQS# referenced to Vih(ac) / Vil(ac) levels              | tDS(base)<br>AC130         | See table for Data Setup and Hold         |         |                 |         | ps       | d,17    |
| Data hold time from DQS, DQS# referenced to Vih(dc) / Vil(dc) levels             | tDH(base)<br>DC100 or DC90 | See table for Data Setup and Hold         |         |                 |         | ps       | d,17    |
| DQ and DM Input pulse width for each input                                       | tDIPW                      | 320                                       | -       | 280             | -       | ps       | 28      |
| <b>Data Strobe Timing</b>  |                            |   |         |                 |         |          |         |
| DQS, DQS# differential READ Preamble   | tRPRE                      | 0.9                                       | Note 19 | 0.9             | Note 19 | tCK(avg) | 13,19,g |
| DQS, DQS# differential READ Postamble  | tRPST                      | 0.3                                       | Note 11 | 0.3             | Note 11 | tCK(avg) | 11,13,g |
| DQS, DQS# differential output high time  | tQSH                       | 0.4                                       | -       | 0.4             | -       | tCK(avg) | 13,g    |
| DQS, DQS# differential output low time   | tQSL                       | 0.4                                       | -       | 0.4             | -       | tCK(avg) | 13,g    |
| DQS, DQS# differential WRITE Preamble  | tWPRE                      | 0.9                                       | -       | 0.9             | -       | tCK(avg) | 1       |
| DQS, DQS# differential WRITE Postamble   | tWPST                      | 0.3                                       | -       | 0.3             | -       | tCK(avg) | 1       |
| DQS, DQS# rising edge output access time from rising CK, CK#                     | tDQSCK                     | -195                                      | 195     | -180            | 180     | ps       | 13,f    |
| DQS and DQS# low-impedance time (Referenced from RL - 1)                         | tLZ(DQS)                   | -390                                      | 195     | -360            | 180     | ps       | 13,14,f |
| DQS and DQS# high-impedance time (Referenced from RL + BL/2)                     | tHZ(DQS)                   | -   | 195     | -               | 180     | ps       | 13,14,f |
| DQS, DQS# differential input low pulse width                                     | tDQSL                      | 0.45                                      | 0.55    | 0.45            | 0.55    | tCK(avg) | 29,31   |
| DQS, DQS# differential input high pulse width                                    | tDQSH                      | 0.45                                      | 0.55    | 0.45            | 0.55    | tCK(avg) | 30,31   |
| DQS, DQS# rising edge to CK, CK# rising edge                                     | tDQSS                      | -0.27                                     | 0.27    | -0.27           | 0.27    | tCK(avg) | c       |
| DQS, DQS# falling edge setup time to CK, CK# rising edge                         | tDSS                       | 0.18                                      | -       | 0.18            | -       | tCK(avg) | c,32    |
| DQS, DQS# falling edge hold time from CK, CK# rising edge                        | tDSH                       | 0.18                                      | -       | 0.18            | -       | tCK(avg) | c,32    |
| <b>Command and Address Timing</b>  |                            |   |         |                 |         |          |         |
| DLL locking time   | tDLLK                      | 512                                       | -       | 512             | -       | nCK      |         |
| Internal READ Command to PRECHARGE Command delay                                 | tRTP                       | tRTPmin.: max(4nCK, 7.5ns)<br>tRTPmax.: - |         |                 |         |          |         |
| Delay from start of internal write transaction to internal read command          | tWTR                       | tWTRmin.: max(4nCK, 7.5ns)<br>tWTRmax.: - |         |                 |         |          |         |
| WRITE recovery time  | tWR                        | 15  | -       | 15              | -       | ns       | e,18    |
| Mode Register Set command cycle time   | tMRD                       | 4   | -       | 4               | -       | nCK      |         |
| Mode Register Set command update delay   | tMOD                       | tMODmin.: max(12nCK, 15ns)<br>tMODmax.: - |         |                 |         |          |         |
| ACT to internal read or write delay time   | tRCD                       | Standard Speed Bins                       |         |                 |         |          |         |
| PRE command period   | tRP                        | Standard Speed Bins                       |         |                 |         |          |         |
| ACT to ACT or REF command period   | tRC                        | Standard Speed Bins                       |         |                 |         |          |         |
| CAS# to CAS# command delay   | tCCD                       | 4   | -       | 4               | -       | nCK      |         |
| Auto precharge write recovery + precharge time                                   | tDAL(min)                  | WR + roundup(tRP / tCK(avg))              |         |                 |         | nCK      |         |
| Multi-Purpose Register Recovery Time   | tMPRR                      | 1   | -       | 1               | -       | nCK      | 22      |
| ACTIVE to PRECHARGE command period   | tRAS                       | Standard Speed Bins                       |         |                 |         |          |         |
| ACTIVE to ACTIVE command period for 1KB page size                                | tRRD                       | max(4nCK, 5ns)                            | -       | max(4nCK, 5ns)  | -       |          | e       |
| ACTIVE to ACTIVE command period for 2KB page size                                | tRRD                       | max(4nCK, 6ns)                            | -       | max(4nCK, 6ns)  | -       |          |         |
| Four activate window for 1KB page size   | tFAW                       | 27  | -       | 25              | -       | ns       | e       |
| Four activate window for 2KB page size   | tFAW                       | 35  | -       | 35              | -       | ns       | e       |
| Command and Address setup time to CK, CK# referenced to Vih(ac) / Vil(ac) levels | tIS(base)<br>AC135         | See table for ADD/CMD setup and hold      |         |                 |         | ps       | b,16    |

| Parameter  | Symbol                     | DDR3/DDR3L-1866                        |      | DDR3/DDR3L-2133      |      | Units | Notes |
|--|----------------------------|--|------|----------------------|------|-------|-------|
|  |                            | Min.                                   | Max. | Min.                 | Max. |       |       |
| Command and Address setup time to CK, CK# referenced to Vih(ac) / Vil(ac) levels   | tIS(base)<br>AC125         |  |      |                      |      | ps    | b,16  |
| Command and Address hold time from CK, CK# referenced to Vih(dc) / Vil(dc) levels  | tIH(base)<br>DC100 or DC90 |  |      |                      |      | ps    | b,16  |
| Control and Address Input pulse width for each input   | tIPW                       | 535                                    | -    | 470                  | -    | ps    | 28    |
| <b>Calibration Timing</b>  |                            |  |      |                      |      |       |       |
| Power-up and RESET calibration time  | tZQinit                    | max (512 nCK, 640ns)                   | -    | max (512 nCK, 640ns) | -    |       |       |
| Normal operation Full calibration time   | tZQoper                    | max (256 nCK, 320ns)                   | -    | max (256 nCK, 320ns) | -    |       |       |
| Normal operation Short calibration time  | tZQCS                      | max (64 nCK, 80ns)                     | -    | max (64 nCK, 80ns)   | -    |       | 23    |
| <b>Reset Timing</b>  |                            |  |      |                      |      |       |       |
| Exit Reset from CKE HIGH to a valid command  | tXPR                       | tXPRmin.: max(5nCK, tRFC(min) + 10ns)  |      |                      |      |       |       |
|  |                            | tXPRmax.: -                            |      |                      |      |       |       |
| <b>Self Refresh Timings</b>  |                            |  |      |                      |      |       |       |
| Exit Self Refresh to commands not requiring a locked DLL   | tXS                        | tXSmin.: max(5nCK, tRFC(min) + 10ns)   |      |                      |      |       |       |
|  |                            | tXSmax.: -                             |      |                      |      |       |       |
| Exit Self Refresh to commands requiring a locked DLL   | tXSDLL                     | tXSDLLmin.: tDLLK(min)                 |      |                      |      | nCK   |       |
|  |                            | tXSDLLmax.: -                          |      |                      |      |       |       |
| Minimum CKE low width for Self Refresh entry to exit timing  | tCKESR                     | tCKESRmin.: tCKE(min) + 1 nCK          |      |                      |      |       |       |
|  |                            | tCKESRmax.: -                          |      |                      |      |       |       |
| Valid Clock Requirement after Self Refresh Entry (SRE) or Power-Down Entry (PDE)   | tCKSRE                     | tCKSREmin.: max(5 nCK, 10 ns)          |      |                      |      |       |       |
|  |                            | tCKSREmax.: -                          |      |                      |      |       |       |
| Valid Clock Requirement before Self Refresh Exit (SRX) or Power-Down Exit (PDX) or Reset Exit                                      | tCKSRX                     | tCKSRXmin.: max(5 nCK, 10 ns)          |      |                      |      |       |       |
|  |                            | tCKSRXmax.: -                          |      |                      |      |       |       |
| <b>Power Down Timings</b>  |                            |  |      |                      |      |       |       |
| Exit Power Down with DLL on to any valid command; Exit Precharge Power Down with DLL frozen to commands not requiring a locked DLL | tXP                        | tXPmin.: max(3nCK, 6ns)                |      |                      |      |       |       |
|  |                            | tXPmax.: -                             |      |                      |      |       |       |
| Exit Precharge Power Down with DLL frozen to commands requiring a locked DLL   | tXPDLL                     | tXPDLLmin.: max(10nCK, 24ns)           |      |                      |      |       | 2     |
|  |                            | tXPDLLmax.: -                          |      |                      |      |       |       |
| CKE minimum pulse width  | tCKE                       | tCKEmin.: max(3nCK 5 ns)               |      |                      |      |       |       |
|  |                            | tCKEmax.: -                            |      |                      |      |       |       |
| Command pass disable delay   | tCPDED                     | tCPDEDmin.: 1                          |      |                      |      | nCK   |       |
|  |                            | tCPDEDmax.: -                          |      |                      |      |       |       |
| Power Down Entry to Exit Timing  | tPD                        | tPDmin.: tCKE(min)                     |      |                      |      |       | 15    |
|  |                            | tPDmax.: 9*tREFI                       |      |                      |      |       |       |
| Timing of ACT command to Power Down entry  | tACTPDEN                   | 1                                      | -    | 2                    | -    | nCK   | 20    |
| Timing of PRE or PREA command to Power Down entry  | tPRPDEN                    | 1                                      | -    | 2                    | -    | nCK   | 20    |
| Timing of RD/RDA command to Power Down entry   | tRDPDEN                    | tRDPDENmin.: RL+4+1                    |      |                      |      | nCK   |       |
|  |                            | tRDPDENmax.: -                         |      |                      |      |       |       |
| Timing of WR command to Power Down entry (BL8OTF, BL8MRS, BC4OTF)  | tWRPDEN                    | tWRPDENmin.: WL + 4 + (tWR / tCK(avg)) |      |                      |      | nCK   | 9     |
|  |                            | tWRPDENmax.: -                         |      |                      |      |       |       |
| Timing of WRA command to Power Down entry (BL8OTF, BL8MRS, BC4OTF)   | tWRAPDEN                   | tWRAPDENmin.: WL+4+WR+1                |      |                      |      | nCK   | 10    |
|  |                            | tWRAPDENmax.: -                        |      |                      |      |       |       |
| Timing of WR command to Power Down entry (BC4MRS)  | tWRPDEN                    | tWRPDENmin.: WL + 2 + (tWR / tCK(avg)) |      |                      |      | nCK   | 9     |
|  |                            | tWRPDENmax.: -                         |      |                      |      |       |       |
| Timing of WRA command to Power Down entry (BC4MRS)   | tWRAPDEN                   | tWRAPDENmin.: WL + 2 +WR + 1           |      |                      |      | nCK   | 10    |
|  |                            | tWRAPDENmax.: -                        |      |                      |      |       |       |
| Timing of REF command to Power Down entry  | tREFPDEN                   | 1                                      | -    | 2                    | -    | nCK   | 20,21 |



| Parameter   | Symbol   | DDR3/DDR3L-1866         |      | DDR3/DDR3L-2133 |      | Units    | Notes |
|---|----------|-------------------------|------|-----------------|------|----------|-------|
|   |          | Min.                    | Max. | Min.            | Max. |          |       |
| Timing of MRS command to Power Down entry   | tMRSPDEN | tMRSPDENmin.: tMOD(min) |      |                 |      |          |       |
|   |          | tMRSPDENmax.: -         |      |                 |      |          |       |
| <b>ODT Timings</b>  |          |                         |      |                 |      |          |       |
| ODT high time without write command or with write command and BC4                   | ODTH4    | ODTH4min.: 4            |      |                 |      | nCK      |       |
|   |          | ODTH4max.: -            |      |                 |      |          |       |
| ODT high time with Write command and BL8  | ODTH8    | ODTH8min.: 6            |      |                 |      | nCK      |       |
|   |          | ODTH8max.: -            |      |                 |      |          |       |
| Asynchronous RTT turn-on delay (Power-Down with DLL frozen)                         | tAONPD   | 2                       | 8.5  | 2               | 8.5  | ns       |       |
| Asynchronous RTT turn-off delay (Power-Down with DLL frozen)                        | tAOFDP   | 2                       | 8.5  | 2               | 8.5  | ns       |       |
| RTT turn-on   | tAON     | -195                    | 195  | -180            | 180  | ps       | 7,f   |
| RTT_Nom and RTT_WR turn-off time from ODTLoff reference                             | tAOF     | 0.3                     | 0.7  | 0.3             | 0.7  | tCK(avg) | 8,f   |
| RTT dynamic change skew   | tADC     | 0.3                     | 0.7  | 0.3             | 0.7  | tCK(avg) | f     |
| <b>Write Leveling Timings</b>   |          |                         |      |                 |      |          |       |
| First DQS/DQS# rising edge after write leveling mode is programmed                  | tWLMRD   | 40                      | -    | 40              | -    | nCK      | 3     |
| DQS/DQS# delay after write leveling mode is programmed                              | tWLDQSEN | 25                      | -    | 25              | -    | nCK      | 3     |
| Write leveling setup time from rising CK, CK# crossing to rising DQS, DQS# crossing | tWLS     | 140                     | -    | 125             | -    | ps       |       |
| Write leveling hold time from rising DQS, DQS# crossing to rising CK, CK# crossing  | tWLH     | 140                     | -    | 125             | -    | ps       |       |
| Write leveling output delay   | tWLO     | 0                       | 7.5  | 0               | 7.5  | ns       |       |
| Write leveling output error   | tWLOE    | 0                       | 2    | 0               | 2    | ns       |       |

## 9.4 Timing Notes

### 9.4.1 Jitter

#### Specific Note a

Unit “tCK(avg)” represents the actual tCK(avg) of the input clock under operation. Unit “nCK” represents one clock cycle of the input clock, counting the actual clock edges. ex) tMRD=4 [nCK] means; if one Mode Register Set command is registered at Tm, another Mode Register Set command may be registered at Tm+4, even if (Tm+4-Tm) is 4 x tCK(avg) + tERR(4per), min.

#### Specific Note b

These parameters are measured from a command/address signal (CKE, CS, RAS, CAS, WE, ODT, BA0, A0, A1, etc) transition edge to its respective clock signal (CK/CK) crossing. The spec values are not affected by the amount of clock jitter applied (i.e. tJIT(per), tJIT(cc), etc.), as the setup and hold are relative to the clock signal crossing that latches the command/address. That is, these parameters should be met whether clock jitter is present or not.

#### Specific Note c

These parameters are measured from a data strobe signal (DQS(L/U), DQS(L/U)) crossing to its respective clock signal (CK, CK) crossing. The spec values are not affected by the amount of clock jitter applied (i.e. tJIT(per), tJIT(cc), etc), as these are relative to the clock signal crossing. That is, these parameters should be met whether clock jitter is present or not.

#### Specific Note d

These parameters are measured from a data signal (DM(L/U), DQ(L/U)0, DQ(L/U)1, etc.) transition edge to its respective data strobe signal (DQS(L/U), DQS(L/U)) crossing.

#### Specific Note e

For these parameters, the DDR3 SDRAM device supports  $t_{nPARAM}[nCK] = RU\{t_{PARAM}[ns] / t_{CK}(avg)[ns]\}$ , which is in clock cycles, assuming all input clock jitter specifications are satisfied. For example, the device will support  $t_{nRP} = RU\{t_{RP}/t_{CK}(avg)\}$ , which is in clock cycles, if all input clock jitter specifications are met. This means: For DDR3-800 6-6-6, of which  $t_{RP} = 15ns$ , the device will support  $t_{nRP} = RU\{t_{RP}/t_{CK}(avg)\} = 6$ , as long as the input clock jitter specifications are met, i.e. Precharge command at  $T_m$  and Active command at  $T_m+6$  is valid even if  $(T_m+6-T_m)$  is less than 15ns due to input clock jitter.

#### Specific Note f

When the device is operated with input clock jitter, this parameter needs to be derated by the actual  $t_{ERR}(mper)$ , act of the input clock, where  $2 \leq m \leq 12$ . (output derating are relative to the SDRAM input clock.)

For example, if the measured jitter into a DDR3-800 SDRAM has  $t_{ERR}(mper),act,min} = -172ps$  and  $t_{ERR}(mper),act,max} = 193ps$ , then  $t_{DQSCK},min(derated) = t_{DQSCK},min} - t_{ERR}(mper),act,max} = -400ps - 193ps = -593ps$  and  $t_{DQSCK},max(derated) = t_{DQSCK},max} - t_{ERR}(mper),act,min} = 400ps + 172ps = 572ps$ . Similarly,  $t_{LZ}(DQ)$  for DDR3-800 derates to  $t_{LZ}(DQ),min(derated) = -800ps - 193ps = -993ps$  and  $t_{LZ}(DQ),max(derated) = 400ps + 172ps = 572ps$ . (Caution on the min/max usage!)

Note that  $t_{ERR}(mper),act,min}$  is the minimum measured value of  $t_{ERR}(nper)$  where  $2 \leq n \leq 12$ , and  $t_{ERR}(mper),act,max}$  is the maximum measured value of  $t_{ERR}(nper)$  where  $2 \leq n \leq 12$ .

#### Specific Note g

When the device is operated with input clock jitter, this parameter needs to be derated by the actual  $t_{JIT}(per),act$  of the input clock. (output deratings are relative to the SDRAM input clock.) For example, if the measured jitter into a DDR3-800 SDRAM has  $t_{CK}(avg),act} = 2500ps$ ,  $t_{JIT}(per),act,min} = -72ps$  and  $t_{JIT}(per),act,max} = 93ps$ , then  $t_{RPRE},min(derated) = t_{RPRE},min} + t_{JIT}(per),act,min} = 0.9 \times t_{CK}(avg),act} + t_{JIT}(per),act,min} = 0.9 \times 2500ps - 72ps = 2178ps$ . Similarly,  $t_{QH},min(derated) = t_{QH},min} + t_{JIT}(per),act,min} = 0.38 \times t_{CK}(avg),act} + t_{JIT}(per),act,min} = 0.38 \times 2500ps - 72ps = 878ps$ . (Caution on the min/max usage!)

### 9.4.2 Timing Parameters

1. Actual value dependent upon measurement level definitions.
2. Commands requiring a locked DLL are: READ ( and RAP) are synchronous ODT commands.
3. The max values are system dependent.
4. WR as programmed in mode register.
5. Value must be rounded-up to next higher integer value.
6. There is no maximum cycle time limit besides the need to satisfy the refresh interval,  $t_{REFI}$ .
7. For definition of RTT-on time  $t_{AON}$  See "Timing Parameters".
8. For definition of RTT-off time  $t_{AOF}$  See "Timing Parameters".
9.  $t_{WR}$  is defined in ns, for calculation of  $t_{WRPDEN}$  it is necessary to round up  $t_{WR} / t_{CK}$  to the next integer.
10. WR in clock cycles are programmed in MR0.
11. The maximum read postamble is bonded by  $t_{DQSCK}(min)$  plus  $t_{QSH}(min)$  on the left side and  $t_{HZ}(DQS)max$  on the right side.
12. Output timing deratings are relative to the SDRAM input clock. When the device is operated with input clock jitter, this parameter needs to be derated by TBD.
13. Value is only valid for RON34.
14. Single ended signal parameter.
15.  $t_{REFI}$  depends on TOPER.
16.  $t_{IS}(base)$  and  $t_{IH}(base)$  values are for 1V/ns CMD/ADD single-ended slew rate and 2V/ns CK, CK differential slew rate. Note for DQ and DM signals,  $V_{REF}(DC) = V_{RefDQ}(DC)$ . For input only pins except RESET,  $V_{Ref}(DC) = V_{RefCA}(DC)$ .
17.  $t_{DS}(base)$  and  $t_{DH}(base)$  values are for 1V/ns DQ single-ended slew rate and 2V/ns DQS, DQS differential slew rate. Note for DQ and DM signals,  $V_{REF}(DC) = V_{RefDQ}(DC)$ . For input only pins except RESET,  $V_{Ref}(DC) = V_{RefCA}(DC)$ .

18. Start of internal write transaction is defined as follows:
  - a. For BL8 (fixed by MRS and on-the-fly): Rising clock edge 4 clock cycles after WL.
  - b. For BC4 (on-the-fly): Rising clock edge 4 clock cycles after WL.
  - c. For BC4 (fixed by MRS): Rising clock edge 2 clock cycles after WL.
19. The maximum preamble is bound by tLZ(DQS)max on the left side and tDQSCK(max) on the right side.
20. CKE is allowed to be registered low while operations such as row activation, precharge, autoprecharge or refresh are in progress, but power-down IDD spec will not be applied until finishing those operations.
21. Although CKE is allowed to be registered LOW after a REFRESH command once tREFPDEN(min) is satisfied, there are cases where additional time such as tXPDLL(min) is also required.
22. Defined between end of MPR read burst and MRS which reloads MPR or disables MPR function.
23. One ZQCS command can effectively correct a minimum of 0.5% (ZQCorrection) of RON and RTT impedance error within 64 nCK for all speed bins assuming the maximum sensitivities specified in the "Output Driver Voltage and Temperature Sensitivity" and "ODT Voltage and Temperature Sensitivity" tables. The appropriate interval between ZQCS commands can be determined from these tables and other application-specific parameters.
24. One method for calculating the interval between ZQCS commands, given the temperature (Tdriftrate) and voltage (Vdriftrate) drift rates that the SDRAM is subject to in the application, is illustrated. the interval could be defined by the following formula:

$$\text{ZQCorrection} / [(\text{TSens} \times \text{Tdriftrate}) + (\text{VSens} \times \text{Vdriftrate})]$$

, where TSens = max(dRTTdT, dRONdTM) and VSens = max(dRTTdV, dRONdVM) define the SDRAM temperature and voltage sensitivities.

For example, if TSens = 1.5%/C, VSens = 0.15%/mV, Tdriftrate = 1 C/sec and Vdriftrate = 15mV/sec, then the interval between ZQCS commands is calculated as

$$0.5 / [(1.5 \times 1) + (0.15 \times 15)] = 0.133 \approx 128\text{ms}$$

25. n = from 13 cycles to 50 cycles. This row defines 38 parameters.
26. tCH(abs) is the absolute instantaneous clock high pulse width, as measured from one rising edge to the following falling edge.
27. tCL(abs) is the absolute instantaneous clock low pulse width, as measured from one falling edge to the following rising edge.
28. The tIS(base) AC150 specifications are adjusted from the tIS(base) specification by adding an additional 100ps of derating to accommodate for the lower alternate threshold of 150mV and another 25ps to account for the earlier reference point  $[(175\text{mV} - 150\text{mV}) / 1\text{V/ns}]$ .
29. Pulse width of a input signal is defined as the width between the first crossing of Vref(dc) and the consecutive crossing of Vref(dc).
30. tDQSL describes the instantaneous differential input low pulse width on DQS - DQS#, as measured from one falling edge to the next consecutive rising edge.
31. tDQSH describes the instantaneous differential input high pulse width on DQS - DQS#, as measured from one rising edge to the next consecutive falling edge.
32. tDQSH,act + tDQSL,act = 1 tCK,act ; with tXYZ,act being the actual measured value of the respective timing parameter in the application.
33. tDSH,act + tDSS,act = 1 tCK,act ; with tXYZ,act being the actual measured value of the respective timing parameter in the application.

**9.5 Address / Command Setup, Hold and Derating**

For all input signals the total tIS (setup time) and tIH (hold time) required is calculated by adding the datasheet tIS(base) and tIH(base) value to the ΔtIS and ΔtIH derating value respectively. Example: tIS (total setup time) = tIS(base) + ΔtIS

Setup (tIS) nominal slew rate for a rising signal is defined as the slew rate between the last crossing of VREF(dc) and the first crossing of VIH(ac)min. Setup (tIS) nominal slew rate for a falling signal is defined as the slew rate between the last crossing of VREF(dc) and the first crossing of Vil(ac)max. If the actual signal is always earlier than the nominal slew rate line between shaded 'VREF(dc) to ac region', use nominal slew rate for derating value. If the actual signal is later than the nominal slew rate line anywhere between shaded 'VREF(dc) to ac region', the slew rate of a tangent line to the actual signal from the ac level to VREF (dc) level is used for derating value.

Hold (tIH) nominal slew rate for a rising signal is defined as the slew rate between the last crossing of Vil(dc)max and the first crossing of VREF(dc). Hold (tIH) nominal slew rate for a falling signal is defined as the slew rate between the last crossing of Vih(dc)min and the first crossing of VREF(dc). If the actual signal is always later than the nominal slew rate line between shaded 'dc to VREF(dc) region', use nominal slew rate for derating value. If the actual signal is earlier than the nominal slew rate line anywhere between shaded 'dc to VREF(dc) region', the slew rate of a tangent line to the actual signal from the dc level to VREF (dc) level is used for derating value.

For a valid transition the input signal has to remain above/below VIH/IL(ac) for some time tVAC. Although for slow slew rates the total setup time might be negative (i.e. a valid input signal will not have reached VIH/IL(ac) at the time of the rising clock transition, a valid input signal is still required to complete the transition and reach VIH/IL(ac). For slew rates in between the values listed in the tables, the derating values may be obtained by linear interpolation.

These values are typically not subject to production test. They are verified by design and characterization.

**9.5.1 ADD/CMD Setup and Hold Base-Values for 1V/ns**

| DDR3/<br>DDR3L | Symbol          | Reference | DDR3-<br>800 | DDR3-<br>1066 | DDR3-<br>1333 | DDR3-<br>1600 | DDR3-<br>1866 | DDR3-<br>2133 | Units |
|----------------|-----------------|-----------|--------------|---------------|---------------|---------------|---------------|---------------|-------|
| DDR3           | tIS(base) AC175 | VIH/L(ac) | 200          | 125           | 65            | 45            | -             | -             | ps    |
|                | tIS(base) AC150 | VIH/L(ac) | 350          | 275           | 190           | 170           | -             | -             | ps    |
|                | tIS(base) AC135 | VIH/L(ac) | -            | -             | -             | -             | 65            | 60            | ps    |
|                | tIS(base) AC125 | VIH/L(ac) | -            | -             | -             | -             | 150           | 135           | ps    |
|                | tIH(base) DC100 | VIH/L(dc) | 275          | 200           | 140           | 120           | 100           | 95            | ps    |
| DDR3L          | tIS(base) AC160 | VIH/L(ac) | 215          | 140           | 80            | 60            | -             | -             | ps    |
|                | tIS(base) AC135 | VIH/L(ac) | 365          | 290           | 205           | 185           | 65            | -             | ps    |
|                | tIS(base) AC125 | VIH/L(ac) | -            | -             | -             | -             | 150           | -             | ps    |
|                | tIH(base) DC90  | VIH/L(dc) | 285          | 210           | 150           | 130           | 110           | -             | ps    |

Note:  
(AC/DC referenced for 1V/ns Address/Command slew rate and 2 V/ns differential CK-CK# slew rate)

9.5.2 Derating values [ps] for DDR3L-800/1066/1333/1600 tIS/tIH - AC/DC based AC160 Threshold

| AC160 Threshold -> VIH(ac) = VREF(dc) + 160mV, VIL(ac) = VREF(dc) - 160mV |     |                                |                 |                 |                 |                 |                 |                 |                 |                 |                 |                 |                 |                 |                 |                 |                 |
|---|-----|--------------------------------|-----------------|-----------------|-----------------|-----------------|-----------------|-----------------|-----------------|-----------------|-----------------|-----------------|-----------------|-----------------|-----------------|-----------------|-----------------|
| DDR3L   |     | CK, CK# Differential Slew Rate |                 |                 |                 |                 |                 |                 |                 |                 |                 |                 |                 |                 |                 |                 |                 |
|   |     | 4.0V/ns                        |                 | 3.0V/ns         |                 | 2.0V/ns         |                 | 1.8V/ns         |                 | 1.6V/ns         |                 | 1.4V/ns         |                 | 1.2V/ns         |                 | 1.0V/ns         |                 |
|   |     | $\Delta t_{IS}$                | $\Delta t_{IH}$ | $\Delta t_{IS}$ | $\Delta t_{IH}$ | $\Delta t_{IS}$ | $\Delta t_{IH}$ | $\Delta t_{IS}$ | $\Delta t_{IH}$ | $\Delta t_{IS}$ | $\Delta t_{IH}$ | $\Delta t_{IS}$ | $\Delta t_{IH}$ | $\Delta t_{IS}$ | $\Delta t_{IH}$ | $\Delta t_{IS}$ | $\Delta t_{IH}$ |
| CMD/ADD<br>Slew Rate<br>V/ns  | 2   | 80                             | 45              | 80              | 45              | 80              | 45              | 88              | 53              | 96              | 61              | 104             | 69              | 112             | 79              | 120             | 95              |
|   | 1.5 | 53                             | 30              | 53              | 30              | 53              | 30              | 61              | 38              | 69              | 46              | 77              | 54              | 85              | 64              | 93              | 80              |
|   | 1   | 0                              | 0               | 0               | 0               | 0               | 0               | 8               | 8               | 16              | 16              | 24              | 24              | 32              | 34              | 40              | 50              |
|   | 0.9 | -1                             | -3              | -1              | -3              | -1              | -3              | 7               | 5               | 15              | 13              | 23              | 21              | 31              | 31              | 39              | 47              |
|   | 0.8 | -3                             | -8              | -3              | -8              | -3              | -8              | 5               | 1               | 13              | 9               | 21              | 17              | 29              | 27              | 37              | 43              |
|   | 0.7 | -5                             | -13             | -5              | -13             | -5              | -13             | 3               | -5              | 11              | 3               | 19              | 11              | 27              | 21              | 35              | 37              |
|   | 0.6 | -8                             | -20             | -8              | -20             | -8              | -20             | 0               | -12             | 8               | -4              | 16              | 4               | 24              | 14              | 32              | 30              |
|   | 0.5 | -20                            | -30             | -20             | -30             | -20             | -30             | -12             | -22             | -4              | -14             | 4               | -6              | 12              | 4               | 20              | 20              |
|   | 0.4 | -40                            | -45             | -40             | -45             | -40             | -45             | -32             | -37             | -24             | -29             | -16             | -21             | -8              | -11             | 0               | 5               |

9.5.3 Derating values [ps] for DDR3L-800/1066/1333/1600 tIS/tIH - AC/DC based AC135 Threshold

| AC135 Threshold -> VIH(ac) = VREF(dc) + 135mV, VIL(ac) = VREF(dc) - 135mV |     |                                |                 |                 |                 |                 |                 |                 |                 |                 |                 |                 |                 |                 |                 |                 |                 |
|---|-----|--------------------------------|-----------------|-----------------|-----------------|-----------------|-----------------|-----------------|-----------------|-----------------|-----------------|-----------------|-----------------|-----------------|-----------------|-----------------|-----------------|
| DDR3L   |     | CK, CK# Differential Slew Rate |                 |                 |                 |                 |                 |                 |                 |                 |                 |                 |                 |                 |                 |                 |                 |
|   |     | 4.0V/ns                        |                 | 3.0V/ns         |                 | 2.0V/ns         |                 | 1.8V/ns         |                 | 1.6V/ns         |                 | 1.4V/ns         |                 | 1.2V/ns         |                 | 1.0V/ns         |                 |
|   |     | $\Delta t_{IS}$                | $\Delta t_{IH}$ | $\Delta t_{IS}$ | $\Delta t_{IH}$ | $\Delta t_{IS}$ | $\Delta t_{IH}$ | $\Delta t_{IS}$ | $\Delta t_{IH}$ | $\Delta t_{IS}$ | $\Delta t_{IH}$ | $\Delta t_{IS}$ | $\Delta t_{IH}$ | $\Delta t_{IS}$ | $\Delta t_{IH}$ | $\Delta t_{IS}$ | $\Delta t_{IH}$ |
| CMD/ADD<br>Slew Rate<br>V/ns  | 2   | 68                             | 45              | 68              | 45              | 68              | 45              | 76              | 53              | 84              | 61              | 92              | 69              | 100             | 79              | 108             | 95              |
|   | 1.5 | 45                             | 30              | 45              | 30              | 45              | 30              | 53              | 38              | 61              | 46              | 69              | 54              | 77              | 64              | 85              | 80              |
|   | 1   | 0                              | 0               | 0               | 0               | 0               | 0               | 8               | 8               | 16              | 16              | 24              | 24              | 32              | 34              | 40              | 50              |
|   | 0.9 | 2                              | -3              | 2               | -3              | 2               | -3              | 10              | 5               | 18              | 13              | 26              | 21              | 34              | 31              | 42              | 47              |
|   | 0.8 | 3                              | -8              | 3               | -8              | 3               | -8              | 11              | 1               | 19              | 9               | 27              | 17              | 35              | 27              | 43              | 43              |
|   | 0.7 | 6                              | -13             | 6               | -13             | 6               | -13             | 14              | -5              | 22              | 3               | 30              | 11              | 38              | 21              | 46              | 37              |
|   | 0.6 | 9                              | -20             | 9               | -20             | 9               | -20             | 17              | -12             | 25              | -4              | 33              | 4               | 41              | 14              | 49              | 30              |
|   | 0.5 | 5                              | -30             | 5               | -30             | 5               | -30             | 13              | -22             | 21              | -14             | 29              | -6              | 37              | 4               | 45              | 20              |
|   | 0.4 | -3                             | -45             | -3              | -45             | -3              | -45             | 6               | -37             | 14              | -29             | 22              | -21             | 30              | -11             | 38              | 5               |

9.5.4 Derating values [ps] for DDR3L-1866 tIS/tIH - AC/DC based AC125 Threshold

| AC125 Threshold -> VIH(ac) = VREF(dc) + 125mV, VIL(ac) = VREF(dc) - 125mV |     |                                |                 |                 |                 |                 |                 |                 |                 |                 |                 |                 |                 |                 |                 |                 |                 |
|---|-----|--------------------------------|-----------------|-----------------|-----------------|-----------------|-----------------|-----------------|-----------------|-----------------|-----------------|-----------------|-----------------|-----------------|-----------------|-----------------|-----------------|
| DDR3L   |     | CK, CK# Differential Slew Rate |                 |                 |                 |                 |                 |                 |                 |                 |                 |                 |                 |                 |                 |                 |                 |
|   |     | 4.0V/ns                        |                 | 3.0V/ns         |                 | 2.0V/ns         |                 | 1.8V/ns         |                 | 1.6V/ns         |                 | 1.4V/ns         |                 | 1.2V/ns         |                 | 1.0V/ns         |                 |
|   |     | $\Delta t_{IS}$                | $\Delta t_{IH}$ | $\Delta t_{IS}$ | $\Delta t_{IH}$ | $\Delta t_{IS}$ | $\Delta t_{IH}$ | $\Delta t_{IS}$ | $\Delta t_{IH}$ | $\Delta t_{IS}$ | $\Delta t_{IH}$ | $\Delta t_{IS}$ | $\Delta t_{IH}$ | $\Delta t_{IS}$ | $\Delta t_{IH}$ | $\Delta t_{IS}$ | $\Delta t_{IH}$ |
| CMD/ADD<br>Slew Rate<br>V/ns  | 2   | 63                             | 45              | 63              | 45              | 63              | 45              | 71              | 53              | 79              | 61              | 87              | 69              | 95              | 79              | 103             | 95              |
|   | 1.5 | 42                             | 30              | 42              | 30              | 42              | 30              | 50              | 38              | 58              | 46              | 66              | 54              | 74              | 64              | 82              | 80              |
|   | 1   | 0                              | 0               | 0               | 0               | 0               | 0               | 8               | 8               | 16              | 16              | 24              | 24              | 32              | 34              | 40              | 50              |
|   | 0.9 | 3                              | -3              | 3               | -3              | 3               | -3              | 11              | 5               | 19              | 13              | 27              | 21              | 35              | 31              | 43              | 47              |
|   | 0.8 | 6                              | -8              | 6               | -8              | 6               | -8              | 14              | 1               | 22              | 9               | 30              | 17              | 38              | 27              | 46              | 43              |
|   | 0.7 | 10                             | -13             | 10              | -13             | 10              | -13             | 18              | -5              | 26              | 3               | 34              | 11              | 42              | 21              | 50              | 37              |
|   | 0.6 | 16                             | -20             | 16              | -20             | 16              | -20             | 24              | -12             | 32              | -4              | 40              | 4               | 48              | 14              | 56              | 30              |
|   | 0.5 | 15                             | -30             | 15              | -30             | 15              | -30             | 23              | -22             | 31              | -14             | 39              | -6              | 47              | 4               | 55              | 20              |
|   | 0.4 | 13                             | -45             | 13              | -45             | 13              | -45             | 21              | -37             | 29              | -29             | 37              | -21             | 45              | -11             | 53              | 5               |

9.5.5 Derating values [ps] for DDR3-800/1066/1333/1600 tIS/tIH - AC/DC based AC175 Threshold

| DDR3                         |     | AC175 Threshold -> VIH(ac) = VREF(dc) + 175mV, VIL(ac) = VREF(dc) - 175mV |                 |                 |                 |                 |                 |                 |                 |                 |                 |                 |                 |                 |                 |                 |                 |
|------------------------------|-----|---|-----------------|-----------------|-----------------|-----------------|-----------------|-----------------|-----------------|-----------------|-----------------|-----------------|-----------------|-----------------|-----------------|-----------------|-----------------|
|                              |     | CK, CK# Differential Slew Rate  |                 |                 |                 |                 |                 |                 |                 |                 |                 |                 |                 |                 |                 |                 |                 |
|                              |     | 4.0V/ns   |                 | 3.0V/ns         |                 | 2.0V/ns         |                 | 1.8V/ns         |                 | 1.6V/ns         |                 | 1.4V/ns         |                 | 1.2V/ns         |                 | 1.0V/ns         |                 |
|                              |     | $\Delta t_{IS}$   | $\Delta t_{IH}$ | $\Delta t_{IS}$ | $\Delta t_{IH}$ | $\Delta t_{IS}$ | $\Delta t_{IH}$ | $\Delta t_{IS}$ | $\Delta t_{IH}$ | $\Delta t_{IS}$ | $\Delta t_{IH}$ | $\Delta t_{IS}$ | $\Delta t_{IH}$ | $\Delta t_{IS}$ | $\Delta t_{IH}$ | $\Delta t_{IS}$ | $\Delta t_{IH}$ |
| CMD/ADD<br>Slew Rate<br>V/ns | 2   | 88  | 50              | 88              | 50              | 88              | 50              | 96              | 58              | 104             | 66              | 112             | 74              | 120             | 84              | 128             | 100             |
|                              | 1.5 | 59  | 34              | 59              | 34              | 59              | 34              | 67              | 42              | 75              | 50              | 83              | 58              | 91              | 68              | 99              | 84              |
|                              | 1   | 0   | 0               | 0               | 0               | 0               | 0               | 8               | 8               | 16              | 16              | 24              | 24              | 32              | 34              | 40              | 50              |
|                              | 0.9 | -2  | -4              | -2              | -4              | -2              | -4              | 6               | 4               | 14              | 12              | 22              | 20              | 30              | 30              | 38              | 46              |
|                              | 0.8 | -6  | -10             | -6              | -10             | -6              | -10             | 2               | -2              | 10              | 6               | 18              | 14              | 26              | 24              | 34              | 40              |
|                              | 0.7 | -11   | -16             | -11             | -16             | -11             | -16             | -3              | -8              | 5               | 0               | 13              | 8               | 21              | 18              | 29              | 34              |
|                              | 0.6 | -17   | -26             | -17             | -26             | -17             | -26             | -9              | -18             | -1              | -10             | 7               | -2              | 15              | 8               | 23              | 24              |
|                              | 0.5 | -35   | -40             | -35             | -40             | -35             | -40             | -27             | -32             | -19             | -24             | -11             | -16             | -2              | -6              | 5               | 10              |
|                              | 0.4 | -62   | -60             | -62             | -60             | -62             | -60             | -54             | -52             | -46             | -44             | -38             | -36             | -30             | -26             | -22             | -10             |

9.5.6 Derating values [ps] for DDR3-800/1066/1333/1600 tIS/tIH - AC/DC based AC150 Threshold

| DDR3                         |     | AC150 Threshold -> VIH(ac) = VREF(dc) + 150mV, VIL(ac) = VREF(dc) - 150mV |                 |                 |                 |                 |                 |                 |                 |                 |                 |                 |                 |                 |                 |                 |                 |
|------------------------------|-----|---|-----------------|-----------------|-----------------|-----------------|-----------------|-----------------|-----------------|-----------------|-----------------|-----------------|-----------------|-----------------|-----------------|-----------------|-----------------|
|                              |     | CK, CK# Differential Slew Rate  |                 |                 |                 |                 |                 |                 |                 |                 |                 |                 |                 |                 |                 |                 |                 |
|                              |     | 4.0V/ns   |                 | 3.0V/ns         |                 | 2.0V/ns         |                 | 1.8V/ns         |                 | 1.6V/ns         |                 | 1.4V/ns         |                 | 1.2V/ns         |                 | 1.0V/ns         |                 |
|                              |     | $\Delta t_{IS}$   | $\Delta t_{IH}$ | $\Delta t_{IS}$ | $\Delta t_{IH}$ | $\Delta t_{IS}$ | $\Delta t_{IH}$ | $\Delta t_{IS}$ | $\Delta t_{IH}$ | $\Delta t_{IS}$ | $\Delta t_{IH}$ | $\Delta t_{IS}$ | $\Delta t_{IH}$ | $\Delta t_{IS}$ | $\Delta t_{IH}$ | $\Delta t_{IS}$ | $\Delta t_{IH}$ |
| CMD/ADD<br>Slew Rate<br>V/ns | 2   | 75  | 50              | 75              | 50              | 75              | 50              | 83              | 58              | 91              | 66              | 99              | 74              | 107             | 84              | 115             | 100             |
|                              | 1.5 | 50  | 34              | 50              | 34              | 50              | 34              | 58              | 42              | 66              | 50              | 74              | 58              | 82              | 68              | 90              | 84              |
|                              | 1   | 0   | 0               | 0               | 0               | 0               | 0               | 8               | 8               | 16              | 16              | 24              | 24              | 32              | 34              | 40              | 50              |
|                              | 0.9 | 0   | -4              | 0               | -4              | 0               | -4              | 8               | 4               | 16              | 12              | 24              | 20              | 32              | 30              | 40              | 46              |
|                              | 0.8 | 0   | -10             | 0               | -10             | 0               | -10             | 8               | -2              | 16              | 6               | 24              | 14              | 32              | 24              | 40              | 40              |
|                              | 0.7 | 0   | -16             | 0               | -16             | 0               | -16             | 8               | -8              | 16              | 0               | 24              | 8               | 32              | 18              | 40              | 34              |
|                              | 0.6 | -1  | -26             | -1              | -26             | -1              | -26             | 7               | -18             | 15              | -10             | 23              | -2              | 31              | 8               | 39              | 24              |
|                              | 0.5 | -10   | -40             | -10             | -40             | -10             | -40             | -2              | -32             | 6               | -24             | 14              | -16             | 22              | -6              | 30              | 10              |
|                              | 0.4 | -25   | -60             | -25             | -60             | -25             | -60             | -17             | -52             | -9              | -44             | -1              | -36             | 7               | -26             | 15              | -10             |

9.5.7 Derating values [ps] for DDR3-1866/2133 tIS/tIH - AC/DC based AC135 Threshold

| DDR3                         |     | AC135 Threshold -> VIH(ac) = VREF(dc) + 135mV, VIL(ac) = VREF(dc) - 135mV |                 |                 |                 |                 |                 |                 |                 |                 |                 |                 |                 |                 |                 |                 |                 |
|------------------------------|-----|---|-----------------|-----------------|-----------------|-----------------|-----------------|-----------------|-----------------|-----------------|-----------------|-----------------|-----------------|-----------------|-----------------|-----------------|-----------------|
|                              |     | CK, CK# Differential Slew Rate  |                 |                 |                 |                 |                 |                 |                 |                 |                 |                 |                 |                 |                 |                 |                 |
|                              |     | 4.0V/ns   |                 | 3.0V/ns         |                 | 2.0V/ns         |                 | 1.8V/ns         |                 | 1.6V/ns         |                 | 1.4V/ns         |                 | 1.2V/ns         |                 | 1.0V/ns         |                 |
|                              |     | $\Delta t_{IS}$   | $\Delta t_{IH}$ | $\Delta t_{IS}$ | $\Delta t_{IH}$ | $\Delta t_{IS}$ | $\Delta t_{IH}$ | $\Delta t_{IS}$ | $\Delta t_{IH}$ | $\Delta t_{IS}$ | $\Delta t_{IH}$ | $\Delta t_{IS}$ | $\Delta t_{IH}$ | $\Delta t_{IS}$ | $\Delta t_{IH}$ | $\Delta t_{IS}$ | $\Delta t_{IH}$ |
| CMD/ADD<br>Slew Rate<br>V/ns | 2   | 68  | 50              | 68              | 50              | 68              | 50              | 76              | 58              | 84              | 66              | 92              | 74              | 100             | 84              | 108             | 100             |
|                              | 1.5 | 45  | 34              | 45              | 34              | 45              | 34              | 53              | 42              | 61              | 50              | 69              | 58              | 77              | 68              | 85              | 84              |
|                              | 1   | 0   | 0               | 0               | 0               | 0               | 0               | 8               | 8               | 16              | 16              | 24              | 24              | 32              | 34              | 40              | 50              |
|                              | 0.9 | 2   | -4              | 2               | -4              | 2               | -4              | 10              | 4               | 18              | 12              | 26              | 20              | 34              | 30              | 42              | 46              |
|                              | 0.8 | 3   | -10             | 3               | -10             | 3               | -10             | 11              | -2              | 19              | 6               | 27              | 14              | 35              | 24              | 43              | 40              |
|                              | 0.7 | 6   | -16             | 6               | -16             | 6               | -16             | 14              | -8              | 22              | 0               | 30              | 8               | 38              | 18              | 46              | 34              |
|                              | 0.6 | 9   | -26             | 9               | -26             | 9               | -26             | 17              | -18             | 25              | -10             | 33              | -2              | 41              | 8               | 49              | 24              |
|                              | 0.5 | 5   | -40             | 5               | -40             | 5               | -40             | 13              | -32             | 21              | -24             | 29              | -16             | 37              | -6              | 45              | 10              |
|                              | 0.4 | -3  | -60             | -3              | -60             | -3              | -60             | 6               | -52             | 14              | -44             | 22              | -36             | 30              | -26             | 38              | -10             |

9.5.8 Derating values [ps] for DDR3-1866/2133 tIS/tIH - AC/DC based AC125 Threshold

| AC125 Threshold -> VIH(ac) = VREF(dc) + 125mV, VIL(ac) = VREF(dc) - 125mV |     |                                |                 |                 |                 |                 |                 |                 |                 |                 |                 |                 |                 |                 |                 |                 |                 |
|---|-----|--------------------------------|-----------------|-----------------|-----------------|-----------------|-----------------|-----------------|-----------------|-----------------|-----------------|-----------------|-----------------|-----------------|-----------------|-----------------|-----------------|
| DDR3  |     | CK, CK# Differential Slew Rate |                 |                 |                 |                 |                 |                 |                 |                 |                 |                 |                 |                 |                 |                 |                 |
|   |     | 4.0V/ns                        |                 | 3.0V/ns         |                 | 2.0V/ns         |                 | 1.8V/ns         |                 | 1.6V/ns         |                 | 1.4V/ns         |                 | 1.2V/ns         |                 | 1.0V/ns         |                 |
|   |     | $\Delta t_{IS}$                | $\Delta t_{IH}$ | $\Delta t_{IS}$ | $\Delta t_{IH}$ | $\Delta t_{IS}$ | $\Delta t_{IH}$ | $\Delta t_{IS}$ | $\Delta t_{IH}$ | $\Delta t_{IS}$ | $\Delta t_{IH}$ | $\Delta t_{IS}$ | $\Delta t_{IH}$ | $\Delta t_{IS}$ | $\Delta t_{IH}$ | $\Delta t_{IS}$ | $\Delta t_{IH}$ |
| CMD/ADD<br>Slew Rate<br>V/ns  | 2   | 63                             | 50              | 63              | 50              | 63              | 50              | 71              | 58              | 79              | 66              | 87              | 74              | 95              | 84              | 103             | 100             |
|   | 1.5 | 42                             | 34              | 42              | 34              | 42              | 34              | 50              | 42              | 58              | 50              | 66              | 58              | 74              | 68              | 82              | 84              |
|   | 1   | 0                              | 0               | 0               | 0               | 0               | 0               | 8               | 8               | 16              | 16              | 24              | 24              | 32              | 34              | 40              | 50              |
|   | 0.9 | 4                              | -4              | 4               | -4              | 4               | -4              | 12              | 4               | 20              | 12              | 28              | 20              | 36              | 30              | 44              | 46              |
|   | 0.8 | 6                              | -10             | 6               | -10             | 6               | -10             | 14              | -2              | 22              | 6               | 30              | 14              | 38              | 24              | 46              | 40              |
|   | 0.7 | 11                             | -16             | 11              | -16             | 11              | -16             | 19              | -8              | 27              | 0               | 35              | 8               | 43              | 18              | 51              | 34              |
|   | 0.6 | 16                             | -26             | 16              | -26             | 16              | -26             | 24              | -18             | 32              | -10             | 40              | -2              | 48              | 8               | 56              | 24              |
|   | 0.5 | 15                             | -40             | 15              | -40             | 15              | -40             | 23              | -32             | 31              | -24             | 39              | -16             | 47              | -6              | 55              | 10              |
|   | 0.4 | 13                             | -60             | 13              | -60             | 13              | -60             | 21              | -52             | 29              | -44             | 37              | -36             | 45              | -26             | 53              | -10             |

9.5.9 Required minimum time tVAC above VIH(ac) {below VIL(ac)} for valid ADD/CMD transition

| Slew Rate<br>[V/ns] | DDR3               |               |               |               | DDR3L              |               |               |               |
|---------------------|--------------------|---------------|---------------|---------------|--------------------|---------------|---------------|---------------|
|                     | 800/1066/1333/1600 |               | 1866/2133     |               | 800/1066/1333/1600 |               | 1866          |               |
|                     | 175mV<br>[ps]      | 150mV<br>[ps] | 135mV<br>[ps] | 125mV<br>[ps] | 160mV<br>[ps]      | 135mV<br>[ps] | 135mV<br>[ps] | 125mV<br>[ps] |
| > 2.0               | 75                 | 175           | 168           | 173           | 200                | 213           | 200           | 205           |
| 2                   | 57                 | 170           | 168           | 173           | 200                | 213           | 200           | 205           |
| 1.5                 | 50                 | 167           | 145           | 152           | 173                | 190           | 178           | 184           |
| 1                   | 38                 | 130           | 100           | 110           | 120                | 145           | 133           | 143           |
| 0.9                 | 34                 | 113           | 85            | 96            | 102                | 130           | 118           | 129           |
| 0.8                 | 29                 | 93            | 66            | 79            | 80                 | 111           | 99            | 111           |
| 0.7                 | 22                 | 66            | 42            | 56            | 51                 | 87            | 75            | 89            |
| 0.6                 | Note               | 30            | 10            | 27            | 13                 | 55            | 43            | 59            |
| 0.5                 | Note               | Note          | Note          | Note          | Note               | 10            | Note          | 18            |
| < 0.5               | Note               | Note          | Note          | Note          | Note               | 10            | Note          | 18            |

Note:  
The rising input signal shall become equal to or greater than VIH(ac) level; and the falling input signal shall become equal to or less than VIL(ac) level



9.5.10 Address / Command Setup, Hold and Derating

9.5.10.1 Nominal slew rate and tVAC for setup time tIS(left) and hold time tIH(right) – ADD/CMD with respect to clock



9.5.10.2 Tangent line for setup time tIS(left) and hold time tIH(right) - ADD/CMD with respect to clock





**9.6 Data Setup, Hold and Slew Rate Derating**

For all input signals the total tDS (setup time) and tDH (hold time) required is calculated by adding the data sheet tDS(base) and tDH(base) value (see corresponding tables) to the ΔtDS and ΔtDH (see corresponding tables) derating value respectively. Example: tDS (total setup time) = tDS(base) + ΔtDS.

Setup (tDS) nominal slew rate for a rising signal is defined as the slew rate between the last crossing of VREF(dc) and the first crossing of VIH(ac) min. Setup (tDS) nominal slew rate for a falling signal is defined as the slew rate between the last crossing of VREF(dc) and the first crossing of VIL(ac) max. If the actual signal is always earlier than the nominal slew rate line between shaded 'VREF(dc) to ac region', use nominal slew rate for derating value. If the actual signal is later than the nominal slew rate line anywhere between shaded 'VREF(dc) to ac region', the slew rate of a tangent line to the actual signal from the ac level to VREF(dc) level is used for derating value.

Hold (tDH) nominal slew rate for a rising signal is defined as the slew rate between the last crossing of VIL(dc) max and the first crossing of VREF(dc) . Hold (tDH) nominal slew rate for a falling signal is defined as the slew rate between the last crossing of VIH(dc) min and the first crossing of VREF(dc). If the actual signal is always later than the nominal slew rate line between shaded 'dc level to VREF(dc) region', use nominal slew rate for derating value. If the actual signal is earlier than the nominal slew rate line anywhere between shaded 'dc to VREF(dc) region', the slew rate of a tangent line to the actual signal from the dc level to VREF(dc) level is used for derating value.

For a valid transition the input signal has to remain above/below VIH/IL(ac) for some time tVAC.

Although for slow slew rates the total setup time might be negative (i.e. a valid input signal will not have reached VIH/IL(ac) at the time of the rising clock transition) a valid input signal is still required to complete the transition and reach VIH/IL(ac) .

For slew rates in between the values listed in the tables, the derating values may obtained by linear interpolation.

These values are typically not subject to production test. They are verified by design and characterization.

**9.6.1 Data Setup and Hold Base-Values**

|       | Symbol          | Reference               | DDR3-800 | DDR3-1066 | DDR3-1333 | DDR3-1600 | DDR3-1866 | DDR3-2133 | Units |
|-------|-----------------|-------------------------|----------|-----------|-----------|-----------|-----------|-----------|-------|
| DDR3  | tDS(base) AC175 | VIH/L(ac),<br>SR= 1V/ns | 75       | 25        | -         | -         | -         | -         | ps    |
|       | tDS(base) AC150 | VIH/L(ac),<br>SR= 1V/ns | 125      | 75        | 30        | 10        | -         | -         | ps    |
|       | tDS(base) AC135 | VIH/L(ac),<br>SR= 1V/ns | 165      | 115       | 60        | 40        | -         | -         | ps    |
|       | tDS(base) AC135 | VIH/L(ac),<br>SR= 2V/ns | -        | -         | -         | -         | 68        | 53        | ps    |
|       | tDH(base) DC100 | VIH/L(dc),<br>SR= 1V/ns | 150      | 100       | 65        | 45        | -         | -         | ps    |
|       | tDH(base) DC100 | VIH/L(dc),<br>SR= 2V/ns | -        | -         | -         | -         | 70        | 55        | ps    |
| DDR3L | tDS(base) AC160 | VIH/L(ac),<br>SR= 1V/ns | 90       | 40        | -         | -         | -         | -         | ps    |
|       | tDS(base) AC135 | VIH/L(ac),<br>SR= 1V/ns | 140      | 90        | 45        | 25        | -         | -         | ps    |
|       | tDS(base) AC130 | VIH/L(ac),<br>SR= 2V/ns | -        | -         | -         | -         | 70        | -         | ps    |
|       | tDH(base) DC90  | VIH/L(dc),<br>SR= 1V/ns | 160      | 110       | 75        | 55        | -         | -         | ps    |
|       | tDH(base) DC90  | VIH/L(dc),<br>SR= 2V/ns | -        | -         | -         | -         | 75        | -         | ps    |

NOTE: (Note: AC/DC referenced for 2V/ns DQ-slew rate and 4V/ns DQS slew rate, or 1V/ns DQ-slew rate and 2V/ns DQS slew rate, as shown.)

9.6.2 Derating values [ps] for DDR3L-800/1066 tDS/tDH - AC/DC based AC160

| AC160 Threshold -> VIH(ac) = VREF(dc) + 160mV, VIL(ac) = VREF(dc) - 160mV |     |                                  |      |         |      |         |      |         |      |         |      |         |      |         |      |         |      |
|---|-----|----------------------------------|------|---------|------|---------|------|---------|------|---------|------|---------|------|---------|------|---------|------|
| DDR3L   |     | DQS, DQS# Differential Slew Rate |      |         |      |         |      |         |      |         |      |         |      |         |      |         |      |
|   |     | 4.0V/ns                          |      | 3.0V/ns |      | 2.0V/ns |      | 1.8V/ns |      | 1.6V/ns |      | 1.4V/ns |      | 1.2V/ns |      | 1.0V/ns |      |
|   |     | ΔtDS                             | ΔtDH | ΔtDS    | ΔtDH | ΔtDS    | ΔtDH | ΔtDS    | ΔtDH | ΔtDS    | ΔtDH | ΔtDS    | ΔtDH | ΔtDS    | ΔtDH | ΔtDS    | ΔtDH |
| DQ Slew Rate V/ns   | 2   | 80                               | 45   | 80      | 45   | 80      | 45   | -       | -    | -       | -    | -       | -    | -       | -    | -       | -    |
|   | 1.5 | 53                               | 30   | 53      | 30   | 53      | 30   | 61      | 38   | -       | -    | -       | -    | -       | -    | -       | -    |
|   | 1   | 0                                | 0    | 0       | 0    | 0       | 0    | 8       | 8    | 16      | 16   | -       | -    | -       | -    | -       | -    |
|   | 0.9 | -                                | -    | -1      | -3   | -1      | -3   | 7       | 5    | 15      | 13   | 23      | 21   | -       | -    | -       | -    |
|   | 0.8 | -                                | -    | -       | -    | -3      | -8   | 5       | 1    | 13      | 9    | 21      | 17   | 29      | 27   | -       | -    |
|   | 0.7 | -                                | -    | -       | -    | -       | -    | 3       | -5   | 11      | 3    | 19      | 11   | 27      | 21   | 35      | 37   |
|   | 0.6 | -                                | -    | -       | -    | -       | -    | -       | -    | 8       | -4   | 16      | 4    | 24      | 14   | 32      | 30   |
|   | 0.5 | -                                | -    | -       | -    | -       | -    | -       | -    | -       | -    | 4       | -6   | 12      | 4    | 20      | 20   |
|   | 0.4 | -                                | -    | -       | -    | -       | -    | -       | -    | -       | -    | -       | -    | -8      | -11  | 0       | 5    |

9.6.3 Derating values [ps] for DDR3L-800/1066/1333/1600 tDS/tDH - AC/DC based AC135 Threshold

| AC135 Threshold -> VIH(ac) = VREF(dc) + 135mV, VIL(ac) = VREF(dc) - 135mV |     |                                  |      |         |      |         |      |         |      |         |      |         |      |         |      |         |      |
|---|-----|----------------------------------|------|---------|------|---------|------|---------|------|---------|------|---------|------|---------|------|---------|------|
| DDR3L   |     | DQS, DQS# Differential Slew Rate |      |         |      |         |      |         |      |         |      |         |      |         |      |         |      |
|   |     | 4.0V/ns                          |      | 3.0V/ns |      | 2.0V/ns |      | 1.8V/ns |      | 1.6V/ns |      | 1.4V/ns |      | 1.2V/ns |      | 1.0V/ns |      |
|   |     | ΔtDS                             | ΔtDH | ΔtDS    | ΔtDH | ΔtDS    | ΔtDH | ΔtDS    | ΔtDH | ΔtDS    | ΔtDH | ΔtDS    | ΔtDH | ΔtDS    | ΔtDH | ΔtDS    | ΔtDH |
| DQ Slew Rate V/ns   | 2   | 68                               | 45   | 68      | 45   | 68      | 45   | -       | -    | -       | -    | -       | -    | -       | -    | -       | -    |
|   | 1.5 | 45                               | 30   | 45      | 30   | 45      | 30   | 53      | 38   | -       | -    | -       | -    | -       | -    | -       | -    |
|   | 1   | 0                                | 0    | 0       | 0    | 0       | 0    | 8       | 8    | 16      | 16   | -       | -    | -       | -    | -       | -    |
|   | 0.9 | -                                | -    | 2       | -3   | 2       | -3   | 10      | 5    | 18      | 13   | 26      | 21   | -       | -    | -       | -    |
|   | 0.8 | -                                | -    | -       | -    | 3       | -8   | 11      | 1    | 19      | 9    | 27      | 17   | 35      | 27   | -       | -    |
|   | 0.7 | -                                | -    | -       | -    | -       | -    | 14      | -5   | 22      | 3    | 30      | 11   | 38      | 21   | 46      | 37   |
|   | 0.6 | -                                | -    | -       | -    | -       | -    | -       | -    | 25      | -4   | 33      | 4    | 41      | 14   | 49      | 30   |
|   | 0.5 | -                                | -    | -       | -    | -       | -    | -       | -    | -       | -    | 29      | -6   | 37      | 4    | 45      | 20   |
|   | 0.4 | -                                | -    | -       | -    | -       | -    | -       | -    | -       | -    | -       | -    | 30      | -11  | 38      | 5    |

9.6.4 Derating values [ps] for DDR3L-1866 tDS/tDH - AC/DC based AC130 Threshold

| AC130 Threshold -> VIH(ac) = VREF(dc) + 130mV, VIL(ac) = VREF(dc) - 130mV |     |                                  |      |         |      |         |      |         |      |         |      |         |      |         |      |         |      |         |      |         |      |         |      |         |      |
|---|-----|----------------------------------|------|---------|------|---------|------|---------|------|---------|------|---------|------|---------|------|---------|------|---------|------|---------|------|---------|------|---------|------|
| DDR3L   |     | DQS, DQS# Differential Slew Rate |      |         |      |         |      |         |      |         |      |         |      |         |      |         |      |         |      |         |      |         |      |         |      |
|   |     | 8.0V/ns                          |      | 7.0V/ns |      | 6.0V/ns |      | 5.0V/ns |      | 4.0V/ns |      | 3.0V/ns |      | 2.0V/ns |      | 1.8V/ns |      | 1.6V/ns |      | 1.4V/ns |      | 1.2V/ns |      | 1.0V/ns |      |
|   |     | ΔtDS                             | ΔtDH | ΔtDS    | ΔtDH | ΔtDS    | ΔtDH | ΔtDS    | ΔtDH | ΔtDS    | ΔtDH | ΔtDS    | ΔtDH | ΔtDS    | ΔtDH | ΔtDS    | ΔtDH | ΔtDS    | ΔtDH | ΔtDS    | ΔtDH | ΔtDS    | ΔtDH | ΔtDS    | ΔtDH |
| DQ Slew Rate V/ns   | 4   | 33                               | 23   | 33      | 23   | 33      | 23   | -       | -    | -       | -    | -       | -    | -       | -    | -       | -    | -       | -    | -       | -    | -       | -    | -       |      |
|   | 3.5 | 28                               | 19   | 28      | 19   | 28      | 19   | -       | -    | -       | -    | -       | -    | -       | -    | -       | -    | -       | -    | -       | -    | -       | -    | -       |      |
|   | 3   | 22                               | 15   | 22      | 15   | 22      | 15   | 22      | 15   | 22      | 15   | -       | -    | -       | -    | -       | -    | -       | -    | -       | -    | -       | -    | -       |      |
|   | 2.5 | -                                | -    | 13      | 9    | 13      | 9    | 13      | 9    | 13      | 9    | 13      | 9    | -       | -    | -       | -    | -       | -    | -       | -    | -       | -    | -       |      |
|   | 2   | -                                | -    | -       | 0    | 0       | 0    | 0       | 0    | 0       | 0    | 0       | 0    | -       | -    | -       | -    | -       | -    | -       | -    | -       | -    | -       |      |
|   | 1.5 | -                                | -    | -       | -    | -       | -    | -22     | -15  | -22     | -15  | -22     | -15  | -22     | -15  | -14     | -7   | -       | -    | -       | -    | -       | -    | -       |      |
|   | 1   | -                                | -    | -       | -    | -       | -    | -       | -    | -65     | -45  | -65     | -45  | -65     | -45  | -57     | -37  | -49     | -29  | -       | -    | -       | -    | -       |      |
|   | 0.9 | -                                | -    | -       | -    | -       | -    | -       | -    | -       | -    | -62     | -48  | -62     | -48  | -54     | -40  | -46     | -32  | -38     | -24  | -       | -    | -       |      |
|   | 0.8 | -                                | -    | -       | -    | -       | -    | -       | -    | -       | -    | -       | -    | -61     | -53  | -53     | -45  | -45     | -37  | -37     | -29  | -29     | -19  | -       |      |
|   | 0.7 | -                                | -    | -       | -    | -       | -    | -       | -    | -       | -    | -       | -    | -       | -    | -49     | -50  | -41     | -42  | -33     | -34  | -25     | -24  | -17     |      |
|   | 0.6 | -                                | -    | -       | -    | -       | -    | -       | -    | -       | -    | -       | -    | -       | -    | -       | -37  | -49     | -29  | -41     | -21  | -31     | -13  | -15     |      |
| 0.5   | -   | -                                | -    | -       | -    | -       | -    | -       | -    | -       | -    | -       | -    | -       | -    | -       | -    | -       | -31  | -51     | -23  | -41     | -15  |         |      |
| 0.4   | -   | -                                | -    | -       | -    | -       | -    | -       | -    | -       | -    | -       | -    | -       | -    | -       | -    | -       | -    | -       | -28  | -56     | -20  |         |      |

9.6.5 Derating values [ps] for DDR3-800/1066 tDS/tDH - AC/DC based AC175 Threshold

| AC175 Threshold -> VIH(ac) = VREF(dc) + 175mV, VIL(ac) = VREF(dc) - 175mV |     |                                  |                 |                 |                 |                 |                 |                 |                 |                 |                 |                 |                 |                 |                 |                 |                 |
|---|-----|----------------------------------|-----------------|-----------------|-----------------|-----------------|-----------------|-----------------|-----------------|-----------------|-----------------|-----------------|-----------------|-----------------|-----------------|-----------------|-----------------|
| DDR3  |     | DQS, DQS# Differential Slew Rate |                 |                 |                 |                 |                 |                 |                 |                 |                 |                 |                 |                 |                 |                 |                 |
|   |     | 4.0V/ns                          |                 | 3.0V/ns         |                 | 2.0V/ns         |                 | 1.8V/ns         |                 | 1.6V/ns         |                 | 1.4V/ns         |                 | 1.2V/ns         |                 | 1.0V/ns         |                 |
|   |     | $\Delta t_{DS}$                  | $\Delta t_{DH}$ | $\Delta t_{DS}$ | $\Delta t_{DH}$ | $\Delta t_{DS}$ | $\Delta t_{DH}$ | $\Delta t_{DS}$ | $\Delta t_{DH}$ | $\Delta t_{DS}$ | $\Delta t_{DH}$ | $\Delta t_{DS}$ | $\Delta t_{DH}$ | $\Delta t_{DS}$ | $\Delta t_{DH}$ | $\Delta t_{DS}$ | $\Delta t_{DH}$ |
| DQ Slew Rate V/ns   | 2   | 88                               | 50              | 88              | 50              | 88              | 50              | -               | -               | -               | -               | -               | -               | -               | -               | -               | -               |
|   | 1.5 | 59                               | 34              | 59              | 34              | 59              | 34              | 67              | 42              | -               | -               | -               | -               | -               | -               | -               | -               |
|   | 1   | 0                                | 0               | 0               | 0               | 0               | 0               | 8               | 8               | 16              | 16              | -               | -               | -               | -               | -               | -               |
|   | 0.9 | -                                | -               | -2              | -4              | -2              | -4              | 6               | 4               | 14              | 12              | 22              | 20              | -               | -               | -               | -               |
|   | 0.8 | -                                | -               | -               | -               | -6              | -10             | 2               | -2              | 10              | 6               | 18              | 14              | 26              | 24              | -               | -               |
|   | 0.7 | -                                | -               | -               | -               | -               | -               | -3              | -8              | 5               | 0               | 13              | 8               | 21              | 18              | 29              | 34              |
|   | 0.6 | -                                | -               | -               | -               | -               | -               | -               | -               | -1              | -10             | 7               | -2              | 15              | 8               | 23              | 24              |
|   | 0.5 | -                                | -               | -               | -               | -               | -               | -               | -               | -               | -               | -11             | -16             | -2              | -6              | 5               | 10              |
|   | 0.4 | -                                | -               | -               | -               | -               | -               | -               | -               | -               | -               | -               | -               | -30             | -26             | -22             | -10             |

9.6.6 Derating values [ps] for DDR3-800/1066/1333/1600 tDS/tDH - AC/DC based AC150 Threshold

| AC150 Threshold -> VIH(ac) = VREF(dc) + 150mV, VIL(ac) = VREF(dc) - 150mV |     |                                  |                 |                 |                 |                 |                 |                 |                 |                 |                 |                 |                 |                 |                 |                 |                 |
|---|-----|----------------------------------|-----------------|-----------------|-----------------|-----------------|-----------------|-----------------|-----------------|-----------------|-----------------|-----------------|-----------------|-----------------|-----------------|-----------------|-----------------|
| DDR3  |     | DQS, DQS# Differential Slew Rate |                 |                 |                 |                 |                 |                 |                 |                 |                 |                 |                 |                 |                 |                 |                 |
|   |     | 4.0V/ns                          |                 | 3.0V/ns         |                 | 2.0V/ns         |                 | 1.8V/ns         |                 | 1.6V/ns         |                 | 1.4V/ns         |                 | 1.2V/ns         |                 | 1.0V/ns         |                 |
|   |     | $\Delta t_{DS}$                  | $\Delta t_{DH}$ | $\Delta t_{DS}$ | $\Delta t_{DH}$ | $\Delta t_{DS}$ | $\Delta t_{DH}$ | $\Delta t_{DS}$ | $\Delta t_{DH}$ | $\Delta t_{DS}$ | $\Delta t_{DH}$ | $\Delta t_{DS}$ | $\Delta t_{DH}$ | $\Delta t_{DS}$ | $\Delta t_{DH}$ | $\Delta t_{DS}$ | $\Delta t_{DH}$ |
| DQ Slew Rate V/ns   | 2   | 75                               | 50              | 75              | 50              | 75              | 50              | -               | -               | -               | -               | -               | -               | -               | -               | -               | -               |
|   | 1.5 | 50                               | 34              | 50              | 34              | 50              | 34              | 58              | 42              | -               | -               | -               | -               | -               | -               | -               | -               |
|   | 1   | 0                                | 0               | 0               | 0               | 0               | 0               | 8               | 8               | 16              | 16              | -               | -               | -               | -               | -               | -               |
|   | 0.9 | -                                | -               | 0               | -4              | 0               | -4              | 8               | 4               | 16              | 12              | 24              | 20              | -               | -               | -               | -               |
|   | 0.8 | -                                | -               | -               | -               | 0               | -10             | 8               | -2              | 16              | 6               | 24              | 14              | 32              | 24              | -               | -               |
|   | 0.7 | -                                | -               | -               | -               | -               | -               | 8               | -8              | 16              | 0               | 24              | 8               | 32              | 18              | 40              | 34              |
|   | 0.6 | -                                | -               | -               | -               | -               | -               | -               | -               | 15              | -10             | 23              | -2              | 31              | 8               | 39              | 24              |
|   | 0.5 | -                                | -               | -               | -               | -               | -               | -               | -               | -               | -               | 14              | -16             | 22              | -6              | 30              | 10              |
|   | 0.4 | -                                | -               | -               | -               | -               | -               | -               | -               | -               | -               | -               | -               | 7               | -26             | 15              | -10             |

9.6.7 Derating values [ps] for DDR3-1866/2133 tDS/tDH - AC/DC based AC135 Threshold

| AC135 Threshold -> VIH(ac) = VREF(dc) + 135mV, VIL(ac) = VREF(dc) - 135mV<br>DC100 Threshold -> VIH(dc) = VREF(dc) + 100mV, VIL(dc) = VREF(dc) - 100mV |     |                                  |                 |                 |                 |                 |                 |                 |                 |                 |                 |                 |                 |                 |                 |                 |                 |                 |                 |                 |                 |                 |                 |                 |                 |
|--|-----|----------------------------------|-----------------|-----------------|-----------------|-----------------|-----------------|-----------------|-----------------|-----------------|-----------------|-----------------|-----------------|-----------------|-----------------|-----------------|-----------------|-----------------|-----------------|-----------------|-----------------|-----------------|-----------------|-----------------|-----------------|
| DDR3   |     | DQS, DQS# Differential Slew Rate |                 |                 |                 |                 |                 |                 |                 |                 |                 |                 |                 |                 |                 |                 |                 |                 |                 |                 |                 |                 |                 |                 |                 |
|  |     | 8.0V/ns                          |                 | 7.0V/ns         |                 | 6.0V/ns         |                 | 5.0V/ns         |                 | 4.0V/ns         |                 | 3.0V/ns         |                 | 2.0V/ns         |                 | 1.8V/ns         |                 | 1.6V/ns         |                 | 1.4V/ns         |                 | 1.2V/ns         |                 | 1.0V/ns         |                 |
|  |     | $\Delta t_{DS}$                  | $\Delta t_{DH}$ | $\Delta t_{DS}$ | $\Delta t_{DH}$ | $\Delta t_{DS}$ | $\Delta t_{DH}$ | $\Delta t_{DS}$ | $\Delta t_{DH}$ | $\Delta t_{DS}$ | $\Delta t_{DH}$ | $\Delta t_{DS}$ | $\Delta t_{DH}$ | $\Delta t_{DS}$ | $\Delta t_{DH}$ | $\Delta t_{DS}$ | $\Delta t_{DH}$ | $\Delta t_{DS}$ | $\Delta t_{DH}$ | $\Delta t_{DS}$ | $\Delta t_{DH}$ | $\Delta t_{DS}$ | $\Delta t_{DH}$ | $\Delta t_{DS}$ | $\Delta t_{DH}$ |
| DQ Slew Rate V/ns  | 4   | 34                               | 25              | 34              | 25              | 34              | 25              | -               | -               | -               | -               | -               | -               | -               | -               | -               | -               | -               | -               | -               | -               | -               | -               | -               |                 |
|  | 3.5 | 29                               | 21              | 29              | 21              | 29              | 21              | -               | -               | -               | -               | -               | -               | -               | -               | -               | -               | -               | -               | -               | -               | -               | -               | -               |                 |
|  | 3   | 23                               | 17              | 23              | 17              | 23              | 17              | 23              | 17              | 23              | 17              | -               | -               | -               | -               | -               | -               | -               | -               | -               | -               | -               | -               | -               |                 |
|  | 2.5 | -                                | -               | 14              | 10              | 14              | 10              | 14              | 10              | 14              | 10              | 14              | 10              | -               | -               | -               | -               | -               | -               | -               | -               | -               | -               | -               |                 |
|  | 2   | -                                | -               | -               | -               | 0               | 0               | 0               | 0               | 0               | 0               | 0               | 0               | 0               | 0               | 0               | -               | -               | -               | -               | -               | -               | -               | -               | -               |
|  | 1.5 | -                                | -               | -               | -               | -               | -               | -23             | -17             | -23             | -17             | -23             | -17             | -23             | -17             | -15             | -9              | -               | -               | -               | -               | -               | -               | -               | -               |
|  | 1   | -                                | -               | -               | -               | -               | -               | -               | -               | -68             | -50             | -68             | -50             | -68             | -50             | -60             | -42             | -52             | -34             | -               | -               | -               | -               | -               | -               |
|  | 0.9 | -                                | -               | -               | -               | -               | -               | -               | -               | -               | -66             | -54             | -66             | -54             | -58             | -46             | -50             | -38             | -42             | -30             | -               | -               | -               | -               | -               |
|  | 0.8 | -                                | -               | -               | -               | -               | -               | -               | -               | -               | -               | -               | -64             | -60             | -56             | -52             | -48             | -44             | -40             | -36             | -32             | -26             | -               | -               | -               |
|  | 0.7 | -                                | -               | -               | -               | -               | -               | -               | -               | -               | -               | -               | -               | -               | -53             | -59             | -45             | -51             | -37             | -43             | -29             | -33             | -21             | -17             | -               |
|  | 0.6 | -                                | -               | -               | -               | -               | -               | -               | -               | -               | -               | -               | -               | -               | -               | -               | -43             | -61             | -35             | -53             | -27             | -43             | -19             | -27             | -               |
|  | 0.5 | -                                | -               | -               | -               | -               | -               | -               | -               | -               | -               | -               | -               | -               | -               | -               | -               | -               | -39             | -66             | -31             | -56             | -23             | -40             | -               |
| 0.4  | -   | -                                | -               | -               | -               | -               | -               | -               | -               | -               | -               | -               | -               | -               | -               | -               | -               | -               | -               | -36             | -76             | -30             | -60             | -               |                 |

9.6.8 Derating values [ps] for DDR3-800/1066/1333/1600 tDS/tDH - AC/DC based AC135 Threshold

| AC135 Threshold -> VIH(ac) = VREF(dc) + 135mV, VIL(ac) = VREF(dc) - 135mV<br>DC100 Threshold -> VIH(dc) = VREF(dc) + 100mV, VIL(dc) = VREF(dc) - 100mV |     |                                  |                 |                 |                 |                 |                 |                 |                 |                 |                 |                 |                 |                 |                 |                 |                 |
|--|-----|----------------------------------|-----------------|-----------------|-----------------|-----------------|-----------------|-----------------|-----------------|-----------------|-----------------|-----------------|-----------------|-----------------|-----------------|-----------------|-----------------|
| DDR3   |     | DQS, DQS# Differential Slew Rate |                 |                 |                 |                 |                 |                 |                 |                 |                 |                 |                 |                 |                 |                 |                 |
|  |     | 4.0V/ns                          |                 | 3.0V/ns         |                 | 2.0V/ns         |                 | 1.8V/ns         |                 | 1.6V/ns         |                 | 1.4V/ns         |                 | 1.2V/ns         |                 | 1.0V/ns         |                 |
|  |     | $\Delta t_{DS}$                  | $\Delta t_{DH}$ | $\Delta t_{DS}$ | $\Delta t_{DH}$ | $\Delta t_{DS}$ | $\Delta t_{DH}$ | $\Delta t_{DS}$ | $\Delta t_{DH}$ | $\Delta t_{DS}$ | $\Delta t_{DH}$ | $\Delta t_{DS}$ | $\Delta t_{DH}$ | $\Delta t_{DS}$ | $\Delta t_{DH}$ | $\Delta t_{DS}$ | $\Delta t_{DH}$ |
| DQ Slew Rate V/ns  | 2   | 68                               | 50              | 68              | 50              | 68              | 50              | -               | -               | -               | -               | -               | -               | -               | -               | -               | -               |
|  | 1.5 | 45                               | 34              | 45              | 34              | 45              | 34              | 53              | 42              | -               | -               | -               | -               | -               | -               | -               | -               |
|  | 1   | 0                                | 0               | 0               | 0               | 0               | 0               | 8               | 8               | 16              | 16              | -               | -               | -               | -               | -               | -               |
|  | 0.9 | -                                | -               | 2               | -4              | 2               | -4              | 10              | 4               | 18              | 12              | 26              | 20              | -               | -               | -               | -               |
|  | 0.8 | -                                | -               | -               | -               | 3               | -10             | 11              | -2              | 19              | 6               | 27              | 14              | 35              | 24              | -               | -               |
|  | 0.7 | -                                | -               | -               | -               | -               | -               | 14              | -8              | 22              | 0               | 30              | 8               | 38              | 18              | 46              | 34              |
|  | 0.6 | -                                | -               | -               | -               | -               | -               | -               | -               | 25              | -10             | 33              | -2              | 41              | 8               | 49              | 24              |
|  | 0.5 | -                                | -               | -               | -               | -               | -               | -               | -               | -               | -               | 29              | -16             | 37              | -6              | 45              | 10              |
| 0.4  | -   | -                                | -               | -               | -               | -               | -               | -               | -               | -               | -               | -               | 30              | -26             | 38              | -10             |                 |

9.6.9 Required minimum time tVAC [ps] above VIH(ac) {below VIL(ac)} for valid DQ transition

| Slew Rate [V/ns] | DDR3     |                    |  |                    |  |      | DDR3L |          |                    |  |       |
|------------------|----------|--------------------|--|--------------------|--|------|-------|----------|--------------------|--|-------|
|                  | 800/1066 | 800/1066/1333/1600 |  | 800/1066/1333/1600 |  | 1866 | 2133  | 800/1066 | 800/1066/1333/1600 |  | 1866  |
|                  | AC175    | AC150              |  | AC135              |  |      |       | AC160    | AC135              |  | AC130 |
| > 2.0            | 75       | 105                |  | 113                |  | 93   | 73    | 165      | 113                |  | 95    |
| 2                | 57       | 105                |  | 113                |  | 93   | 73    | 165      | 113                |  | 95    |
| 1.5              | 50       | 80                 |  | 90                 |  | 70   | 50    | 138      | 90                 |  | 73    |
| 1                | 38       | 30                 |  | 45                 |  | 25   | 5     | 85       | 45                 |  | 30    |
| 0.9              | 34       | 13                 |  | 30                 |  | Note | Note  | 67       | 30                 |  | 16    |
| 0.8              | 29       | Note               |  | 11                 |  | Note | Note  | 45       | 11                 |  | Note  |
| 0.7              | Note     | Note               |  | Note               |  | -    | -     | 16       | Note               |  | -     |
| 0.6              | Note     | Note               |  | Note               |  | -    | -     | Note     | Note               |  | -     |
| 0.5              | Note     | Note               |  | Note               |  | -    | 2     | Note     | Note               |  | -     |
| < 0.5            | Note     | Note               |  | Note               |  | -    | -     | Note     | Note               |  | -     |

Note:  
The rising input signal shall become equal to or greater than VIH(ac) level; and the falling input signal shall become equal to or less than VIL(ac) level.

9.6.10 Data Setup, Hold and Slew Rate Derating

9.6.10.1 Nominal slew rate and tVAC for setup time tDS(left) and hold time tDH(right) - DQ with respect to strobe



9.6.10.2 Tangent line for setup time tDS(left) and hold time tDH(right) - DQ with respect to strobe

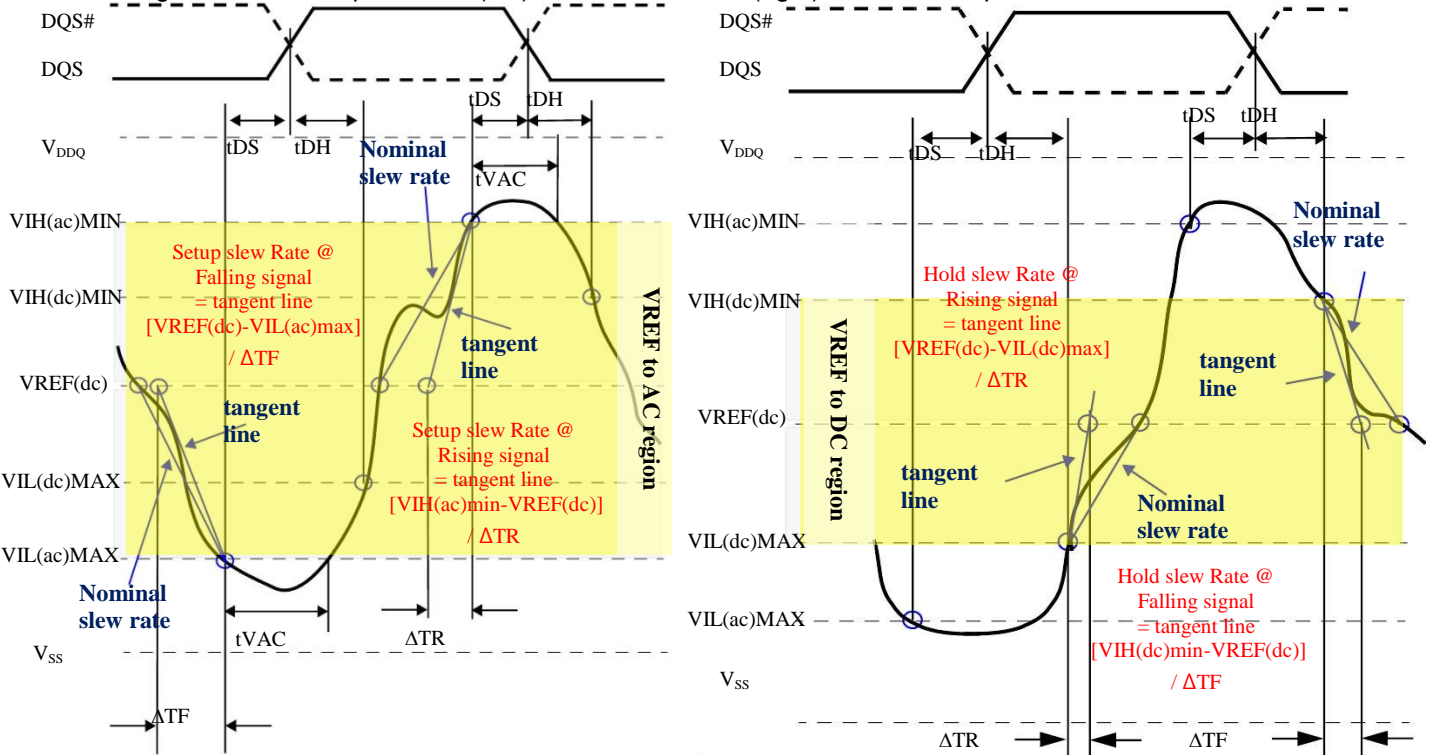

**IS43/46TR16128C, IS43/46TR16128CL,  
IS43/46TR82560C, IS43/46TR82560CL**

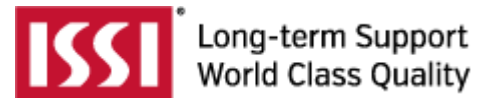

**ORDERING INFORMATION, 128Mx16, 1.5V (DDR3)**

**128Mx16 - Commercial Range: (0°C ≤ T<sub>c</sub> ≤ 95°C)**

| Data Rate | CL-tRCD-tRP | Order Part No.      | Package                |
|-----------|-------------|---------------------|------------------------|
| 1333MT/s  | 9-9-9       | IS43TR16128C-15HBL  | 96-ball BGA, Lead-free |
| 1600MT/s  | 11-11-11    | IS43TR16128C-125KBL | 96-ball BGA, Lead-free |
| 1866MT/s  | 13-13-13    | IS43TR16128C-107MBL | 96-ball BGA, Lead-free |

**128Mx16 - Industrial Range: (-40°C ≤ T<sub>c</sub> ≤ 95°C)**

| Data Rate | CL-tRCD-tRP | Order Part No.       | Package                |
|-----------|-------------|----------------------|------------------------|
| 1333MT/s  | 9-9-9       | IS43TR16128C-15HBLI  | 96-ball BGA, Lead-free |
| 1600MT/s  | 11-11-11    | IS43TR16128C-125KBLI | 96-ball BGA, Lead-free |
| 1866MT/s  | 13-13-13    | IS43TR16128C-107MBLI | 96-ball BGA, Lead-free |

**128Mx16 – Automotive, A1 Range: (-40°C ≤ T<sub>c</sub> ≤ 95°C)**

| Data Rate | CL-tRCD-tRP | Order Part No.        | Package                |
|-----------|-------------|-----------------------|------------------------|
| 1333MT/s  | 9-9-9       | IS46TR16128C-15HBLA1  | 96-ball BGA, Lead-free |
| 1600MT/s  | 11-11-11    | IS46TR16128C-125KBLA1 | 96-ball BGA, Lead-free |
| 1866MT/s  | 13-13-13    | IS46TR16128C-107MBLA1 | 96-ball BGA, Lead-free |

**128Mx16 – Automotive, A2 Range: (-40°C ≤ T<sub>c</sub> ≤ 105°C)**

| Data Rate | CL-tRCD-tRP | Order Part No.        | Package                |
|-----------|-------------|-----------------------|------------------------|
| 1333MT/s  | 9-9-9       | IS46TR16128C-15HBLA2  | 96-ball BGA, Lead-free |
| 1600MT/s  | 11-11-11    | IS46TR16128C-125KBLA2 | 96-ball BGA, Lead-free |

Note: Contact ISSI for availability of options.

**IS43/46TR16128C, IS43/46TR16128CL,  
IS43/46TR82560C, IS43/46TR82560CL**

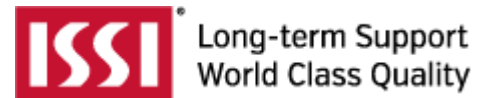

**ORDERING INFORMATION, 128Mx16, 1.35V (DDR3L)**

**128Mx16 - Commercial Range: (0°C ≤ T<sub>C</sub> ≤ 95°C)**

| Data Rate | CL-tRCD-tRP | Order Part No.       | Package                |
|-----------|-------------|----------------------|------------------------|
| 1333MT/s  | 9-9-9       | IS43TR16128CL-15HBL  | 96-ball BGA, Lead-free |
| 1600MT/s  | 11-11-11    | IS43TR16128CL-125KBL | 96-ball BGA, Lead-free |

**128Mx16 - Industrial Range: (-40°C ≤ T<sub>C</sub> ≤ 95°C)**

| Data Rate | CL-tRCD-tRP | Order Part No.        | Package                |
|-----------|-------------|-----------------------|------------------------|
| 1333MT/s  | 9-9-9       | IS43TR16128CL-15HBLI  | 96-ball BGA, Lead-free |
| 1600MT/s  | 11-11-11    | IS43TR16128CL-125KBLI | 96-ball BGA, Lead-free |

**128Mx16 – Automotive, A1 Range: (-40°C ≤ T<sub>C</sub> ≤ 95°C)**

| Data Rate | CL-tRCD-tRP | Order Part No.         | Package                |
|-----------|-------------|------------------------|------------------------|
| 1333MT/s  | 9-9-9       | IS46TR16128CL-15HBLA1  | 96-ball BGA, Lead-free |
| 1600MT/s  | 11-11-11    | IS46TR16128CL-125KBLA1 | 96-ball BGA, Lead-free |

**128Mx16 – Automotive, A2 Range: (-40°C ≤ T<sub>C</sub> ≤ 105°C)**

| Data Rate | CL-tRCD-tRP | Order Part No.         | Package                |
|-----------|-------------|------------------------|------------------------|
| 1333MT/s  | 9-9-9       | IS46TR16128CL-15HBLA2  | 96-ball BGA, Lead-free |
| 1600MT/s  | 11-11-11    | IS46TR16128CL-125KBLA2 | 96-ball BGA, Lead-free |

Note: Contact ISSI for availability of options.

**IS43/46TR16128C, IS43/46TR16128CL,  
IS43/46TR82560C, IS43/46TR82560CL**

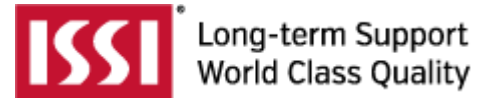

**ORDERING INFORMATION, 256Mx8, 1.5V (DDR3)**

**256Mx8 - Commercial Range: (0°C ≤ T<sub>C</sub> ≤ 95°C)**

| Data Rate | CL-tRCD-tRP | Order Part No.      | Package               |
|-----------|-------------|---------------------|-----------------------|
| 1333MT/s  | 9-9-9       | IS43TR82560C-15HBL  | 78-ball BGA,Lead-free |
| 1600MT/s  | 11-11-11    | IS43TR82560C-125KBL | 78-ball BGA,Lead-free |
| 1866MT/s  | 13-13-13    | IS43TR82560C-107MBL | 78-ball BGA,Lead-free |

**256Mx8 - Industrial Range: (-40°C ≤ T<sub>C</sub> ≤ 95°C)**

| Data Rate | CL-tRCD-tRP | Order Part No.       | Package               |
|-----------|-------------|----------------------|-----------------------|
| 1333MT/s  | 9-9-9       | IS43TR82560C-15HBLI  | 78-ball BGA,Lead-free |
| 1600MT/s  | 11-11-11    | IS43TR82560C-125KBLI | 78-ball BGA,Lead-free |
| 1866MT/s  | 13-13-13    | IS43TR82560C-107MBLI | 78-ball BGA,Lead-free |

**256Mx8 – Automotive, A1 Range: (-40°C ≤ T<sub>C</sub> ≤ 95°C)**

| Data Rate | CL-tRCD-tRP | Order Part No.        | Package               |
|-----------|-------------|-----------------------|-----------------------|
| 1333MT/s  | 9-9-9       | IS46TR82560C-15HBLA1  | 78-ball BGA,Lead-free |
| 1600MT/s  | 11-11-11    | IS46TR82560C-125KBLA1 | 78-ball BGA,Lead-free |
| 1866MT/s  | 13-13-13    | IS46TR82560C-107MBLA1 | 78-ball BGA,Lead-free |

**256Mx8 – Automotive, A2 Range: (-40°C ≤ T<sub>C</sub> ≤ 105°C)**

| Data Rate | CL-tRCD-tRP | Order Part No.        | Package               |
|-----------|-------------|-----------------------|-----------------------|
| 1333MT/s  | 9-9-9       | IS46TR82560C-15HBLA2  | 78-ball BGA,Lead-free |
| 1600MT/s  | 11-11-11    | IS46TR82560C-125KBLA2 | 78-ball BGA,Lead-free |

Note: Contact ISSI for availability of options.



**IS43/46TR16128C, IS43/46TR16128CL,  
IS43/46TR82560C, IS43/46TR82560CL**

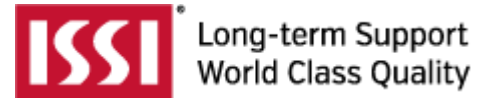

**ORDERING INFORMATION, 256Mx8, 1.35V (DDR3L)**

**256Mx8 - Commercial Range: (0°C ≤ T<sub>C</sub> ≤ 95°C)**

| Data Rate | CL-tRCD-tRP | Order Part No.       | Package               |
|-----------|-------------|----------------------|-----------------------|
| 1333MT/s  | 9-9-9       | IS43TR82560CL-15HBL  | 78-ball BGA,Lead-free |
| 1600MT/s  | 11-11-11    | IS43TR82560CL-125KBL | 78-ball BGA,Lead-free |

**256Mx8 - Industrial Range: (-40°C ≤ T<sub>C</sub> ≤ 95°C)**

| Data Rate | CL-tRCD-tRP | Order Part No.        | Package               |
|-----------|-------------|-----------------------|-----------------------|
| 1333MT/s  | 9-9-9       | IS43TR82560CL-15HBLI  | 78-ball BGA,Lead-free |
| 1600MT/s  | 11-11-11    | IS43TR82560CL-125KBLI | 78-ball BGA,Lead-free |

**256Mx8 – Automotive, A1 Range: (-40°C ≤ T<sub>C</sub> ≤ 95°C)**

| Data Rate | CL-tRCD-tRP | Order Part No.         | Package               |
|-----------|-------------|------------------------|-----------------------|
| 1333MT/s  | 9-9-9       | IS46TR82560CL-15HBLA1  | 78-ball BGA,Lead-free |
| 1600MT/s  | 11-11-11    | IS46TR82560CL-125KBLA1 | 78-ball BGA,Lead-free |

**256Mx8 – Automotive, A2 Range: (-40°C ≤ T<sub>C</sub> ≤ 105°C)**

| Data Rate | CL-tRCD-tRP | Order Part No.         | Package               |
|-----------|-------------|------------------------|-----------------------|
| 1333MT/s  | 9-9-9       | IS46TR82560CL-15HBLA2  | 78-ball BGA,Lead-free |
| 1600MT/s  | 11-11-11    | IS46TR82560CL-125KBLA2 | 78-ball BGA,Lead-free |

Note: Contact ISSI for availability of options.

IS43/46TR16128C, IS43/46TR16128CL,  
IS43/46TR82560C, IS43/46TR82560CL

**PACKAGE OUTLINE DRAWING**

96-ball BGA (9mm x 13mm)



|             |       |  |        |                 |
|-------------|-------|--|--------|-----------------|
| <b>ISSI</b> | TITLE | 96L 9x13x1.2mm TW-BGA<br>Package Outline | REV. C | DATE 09/14/2016 |
|-------------|-------|--|--------|-----------------|

IS43/46TR16128C, IS43/46TR16128CL,  
IS43/46TR82560C, IS43/46TR82560CL

**PACKAGE OUTLINE DRAWING**

78-ball BGA (8mm x 10.5mm)

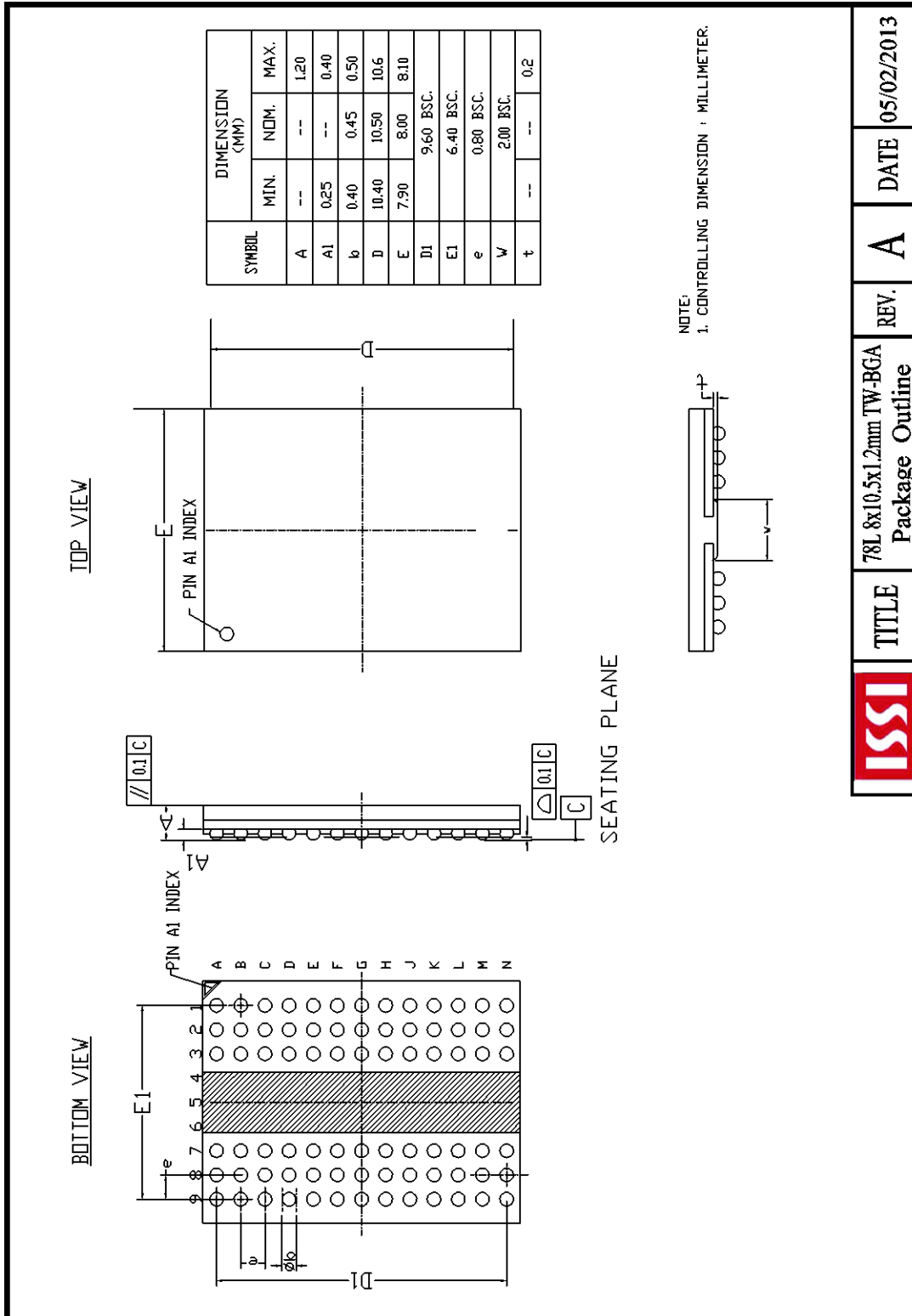

|             |  |      |            |
|-------------|--|------|------------|
| <b>ISSI</b> | TITLE                                      | REV. | DATE       |
|             | 78L 8x10.5x1.2mm TW-BGA<br>Package Outline | A    | 05/02/2013 |



## Стандарт Электрон Связь

Мы молодая и активно развивающаяся компания в области поставок электронных компонентов. Мы поставляем электронные компоненты отечественного и импортного производства напрямую от производителей и с крупнейших складов мира.

Благодаря сотрудничеству с мировыми поставщиками мы осуществляем комплексные и плановые поставки широчайшего спектра электронных компонентов.

Собственная эффективная логистика и склад в обеспечивает надежную поставку продукции в точно указанные сроки по всей России.

Мы осуществляем техническую поддержку нашим клиентам и предпродажную проверку качества продукции. На все поставляемые продукты мы предоставляем гарантию .

Осуществляем поставки продукции под контролем ВП МО РФ на предприятия военно-промышленного комплекса России , а также работаем в рамках 275 ФЗ с открытием отдельных счетов в уполномоченном банке. Система менеджмента качества компании соответствует требованиям ГОСТ ISO 9001.

Минимальные сроки поставки, гибкие цены, неограниченный ассортимент и индивидуальный подход к клиентам являются основой для выстраивания долгосрочного и эффективного сотрудничества с предприятиями радиоэлектронной промышленности, предприятиями ВПК и научно-исследовательскими институтами России.

С нами вы становитесь еще успешнее!

### Наши контакты:

**Телефон:** +7 812 627 14 35

**Электронная почта:** [sales@st-electron.ru](mailto:sales@st-electron.ru)

**Адрес:** 198099, Санкт-Петербург,  
Промышленная ул, дом № 19, литера Н,  
помещение 100-Н Офис 331