



NOTE

All numerical values are in metric units [with U.S. customary units in brackets]. Dimensions are in millimeters [and inches]. Unless otherwise specified, dimensions have a tolerance of ± 0.13 [± 0.005] and angles have a tolerance of $\pm 2^\circ$. Figures and illustrations are for identification only and are not drawn to scale.

1. INTRODUCTION

This specification covers the requirements for application of 3.9-mm pitch 85-ohm and 100-ohm CP and DPO STRADA Whisper connector system. This connector system uses a modular concept and interconnects two printed circuit (pc) boards. The connectors are available in CP and DPO header assemblies. Each header assembly consists of a vertical plug and a right-angle receptacle that connect to the pc board via eye-of-needle (EON) compliant pin press-fit contacts. The differential pair contacts are arranged pair in-row (PiR) or pair in-column (PiC). These header assemblies mate to standard receptacles having the same contact arrangement.

When corresponding with personnel, use the terminology provided in this specification to facilitate inquiries for information. Basic terms and features of this product are provided in Figure 1.

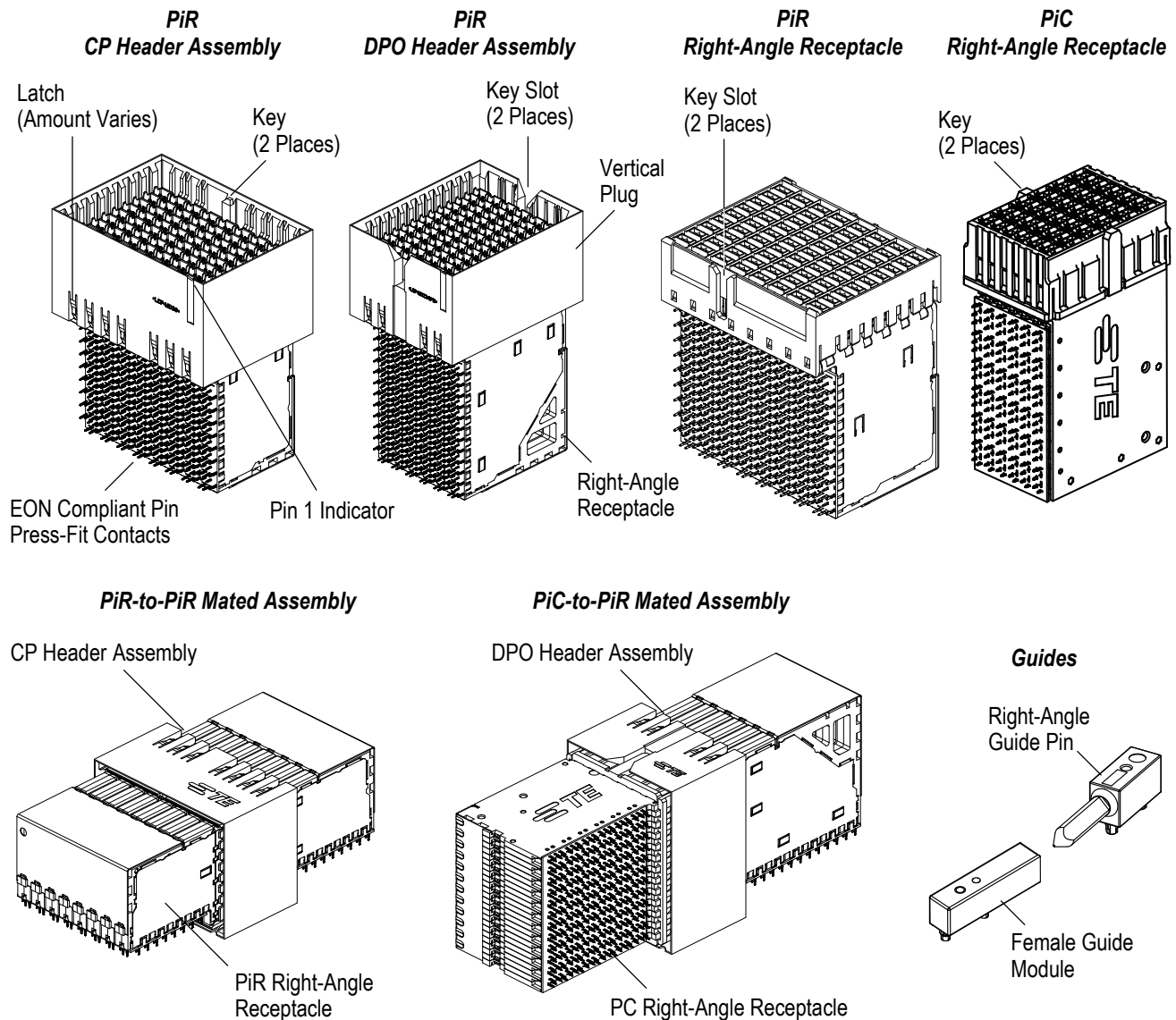

Figure 1

When mating, alignment features help align contacts prior to engagement of the connectors. Mating connector keys fit into the mating connector key slots, which have a guide feature. In addition, guides are available and should be used with the connectors to provide error-free mating and prevent damage to the connector housings and contacts.

The guide pin and female guide module are designed to be installed onto the pc board. Guides are also recommended for multi-connector, large and heavy daughtercard applications, and conditions where the misalignment tolerances cannot be met. The guide pin is available with internal or external threading.

2. REFERENCE MATERIAL

2.1. Revision Summary

Initial release of application specification

2.2. Customer Assistance

Reference Product Base Part Numbers 2187353 (PiR CP receptacle), 2274765 (PiR CP header assembly), 2198174 (PiC DPO receptacle), and 2274518 (PiR DPO header assembly) and Product Code M284 are representative of 3.9-mm pitch 85-ohm and 100-ohm CP and DPO STRADA Whisper connector system. Use of these numbers will identify the product line and help you to obtain product and tooling information. Such information can be obtained through a local Representative, by visiting our website at www.te.com, or by calling PRODUCT INFORMATION or the TOOLING ASSISTANCE CENTER at the numbers at the bottom of page 1.

2.3. Drawings

Customer Drawings for product part numbers are available from the service network. If there is a conflict between the information contained in the Customer Drawings and this specification or with any other technical documentation supplied, the information contained in the Customer Drawings takes priority.

2.4. Specifications

Product Specification [108-32075](#) provides expected product performance and test results.

3. REQUIREMENTS

3.1. Storage

A. Shelf Life

The product should remain in the shipping containers until ready for use to prevent deformation to components. The product should be used on a first in, first out basis to avoid storage contamination that could adversely affect performance.

B. Chemical Exposure

Do not store product near any chemical listed below as they may cause stress corrosion cracking in the material.

Alkalies	Ammonia	Citrates	Phosphates	Citrates	Sulfur Compounds
Amines	Carbonates	Nitrites	Sulfur	Nitrites	Tartrates

3.2. Material

The housings and chicklets are molded of high-temperature rated (UL 94V-0) thermoplastic. The contacts are made of copper alloy and plated at the contact interface with precious metal. All contacts have a nickel underplate and tin or tin lead plated press-fit leads. Refer to the specific connector customer drawing for details.

3.3. Pin Lengths

The pin length of the ground and signal contacts is given in Figure 2.

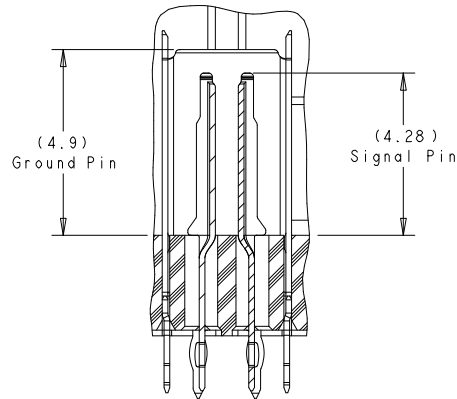

Note: Contact TE for other pin lengths

Figure 2

3.4. PC Board

A. Material and Thickness

The pc board material shall be glass epoxy (for example, FR-4).

For connector compliant pins, the daughtercard and backplane must have a minimum thickness of 1.25. For pc boards with a thickness less than 2, a pc board support must be positioned directly under the pc board.

To accommodate an internally-threaded guide pin, the pc board must have a thickness equal to or greater than the thread length of the guide pin. To accommodate an externally-threaded guide pin, the pc board must have a thickness less than the thread length of the guide pin. A pc board support must be positioned directly under the pc board.

When using guide modules on a pc board with a thickness less than 4.5, a pc board support must be positioned directly under the pc board.



NOTE

All pc board supports must meet the requirements described in Section 5.

3.5. Layout

The pc board layouts are provided on the specific connector customer drawing.

A. Hole Configuration

The holes in the pc board for all contacts must be drilled and plated through to the dimensions given in Figure 3. Dimension for pc board that are to be back-drilled (counterbored) for signal integrity (SI) performance is also given.



NOTE

The nominal finished hole diameter (dimension A) is supplied for reference only. Although it may be used as an inspection dimension, proper plated through hole (PTH) composition can only be determined via radial and longitudinal cross sectioning of the PTH. Radial sectioning verifies that the specified PTH component dimensions are achieved, i.e., drill diameter, copper plating, and other specified plating thicknesses. Longitudinal sectioning will verify plating uniformity throughout the pc board thickness. Deviation from the requirements listed in Figure 3.

PC Board Holes

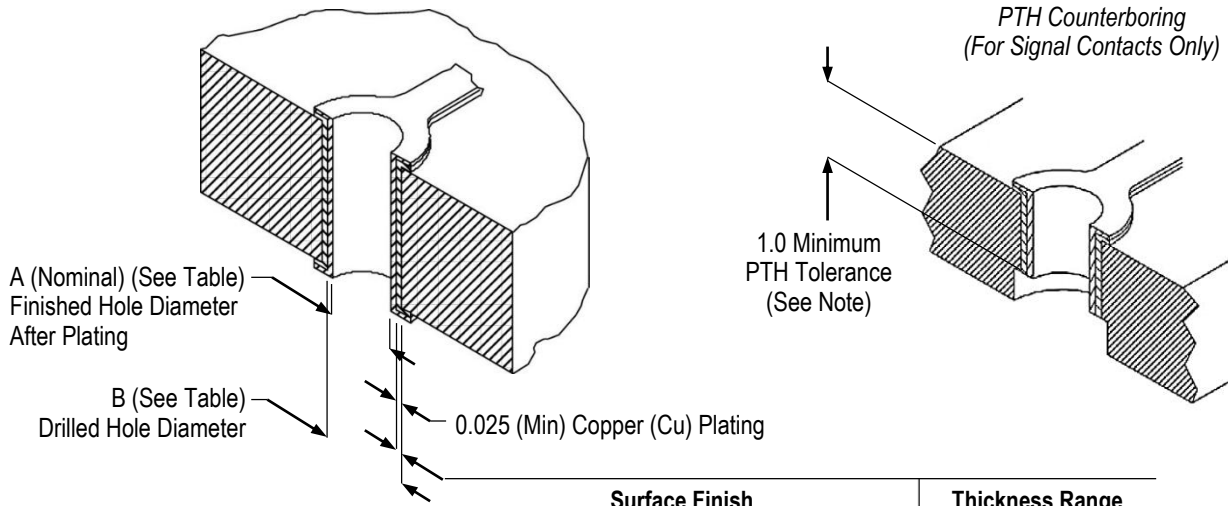

Surface Finish	Thickness Range
Hot Air Solder Leveling (HASL) Tin-Lead (SnPb)	0.004-0.010
Immersion Tin (Sn)	0.0006-0.0011
Organic Solderability Preservative (OSP)	0.0002-0.0005

Note: PTH tolerance for signal applies to the top 1.0 of the component side of the pc board. PTH tolerance for ground applies to the top 1.25 of the component side of the pc board *after* the minimum PTH tolerance applies.

CONNECTOR			DIMENSION	
TYPE	CONTACT ARRANGEMENT	EON CONTACT	A (Nominal)	B±0.025
85-Ohm CP Header Assembly and Receptacle	PiR	Signal	0.29±0.05	0.368
		Ground and SI Via	0.37±0.05	0.45
100-Ohm DPO Header Assembly	PiR	Signal	0.24±0.04	0.32
		Ground	0.34±0.05	0.42
		SI Via	0.22 (Ref)	0.30
100-Ohm DPO Receptacle	PIC	Signal	0.24±0.04	0.32
		Ground and SI Via	0.37±0.05	0.45

Figure 3

3.6. Connector Spacing



NOTE

When using these connectors with similar connectors or components, contact *PRODUCT INFORMATION* at the bottom of page 1 for the recommended spacing.

Recommended spacing for PiR CP header assemblies and PiR right-angle receptacles with power modules are given in Figure 4.

**Recommended Spacing for
85-Ohm PiR CP Header Assembly and PiR Right-Angle Receptacle With Universal Power Modules**

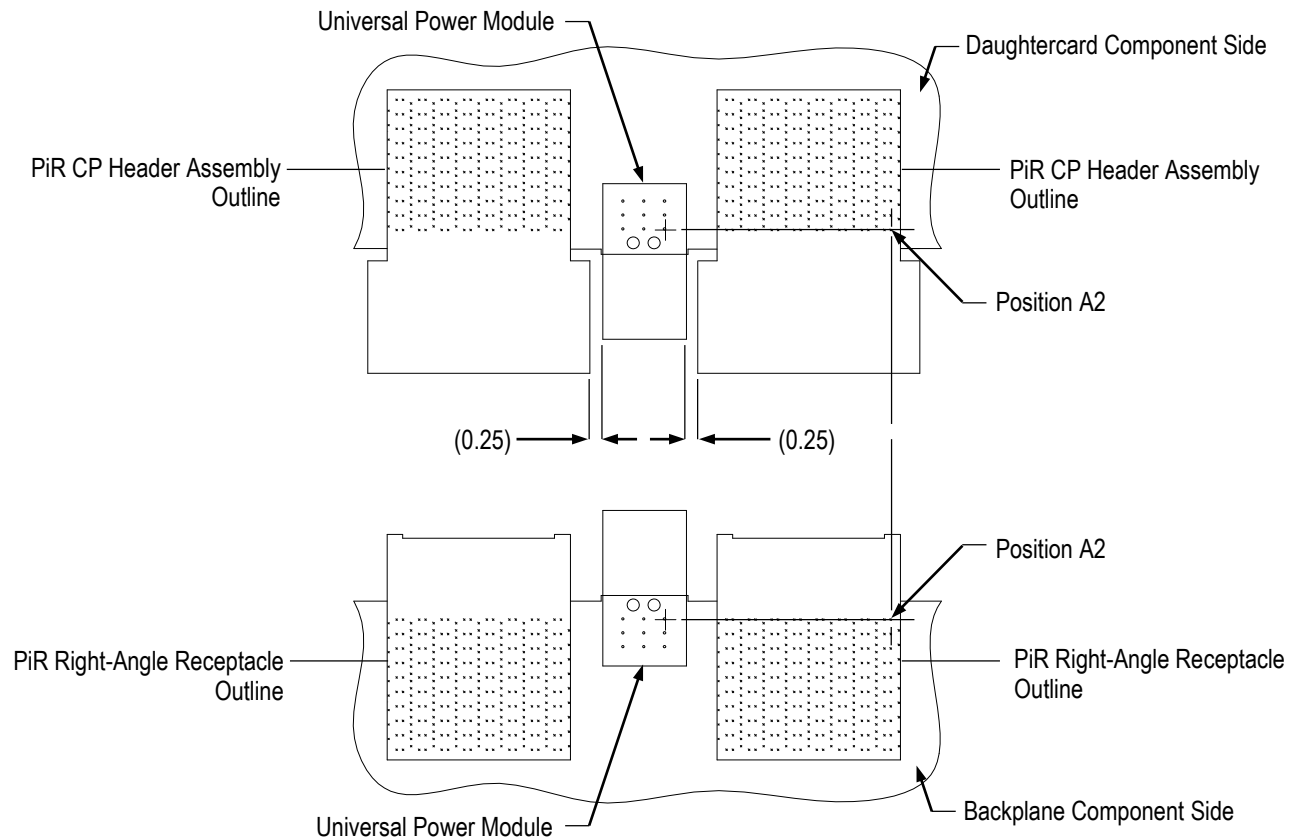

Note: Connector footprint true position requirements are given on the customer drawings

POWER MODULE OPERATING VOLTAGE	DIMENSION A (Min)
50 V	1.2
250 V	12.5

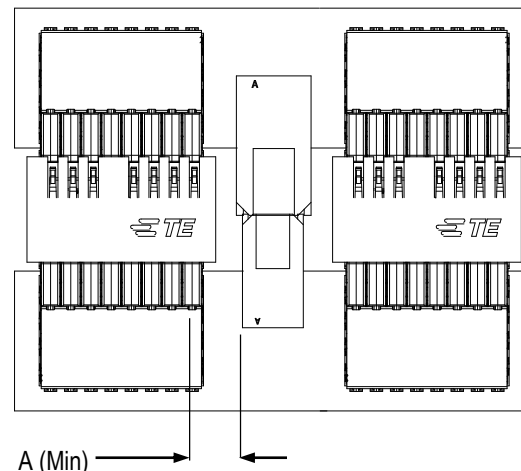

Figure 4

3.7. Placement

A. Connector

Connectors can be placed on the pc board end-to-end within the specified dimensions given in Figure 5.

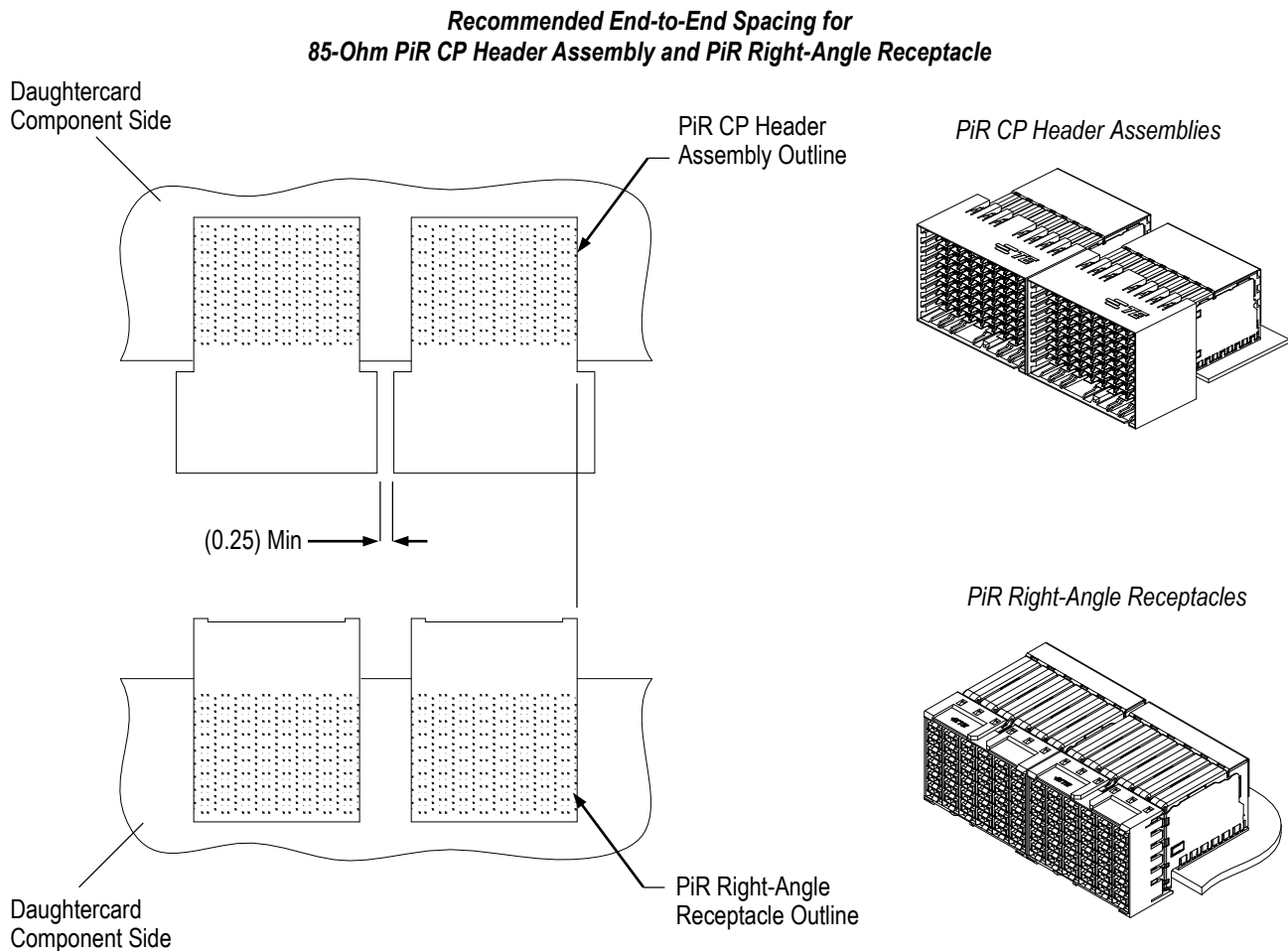

Figure 5 (Cont'd)

**Recommended End-to-End Spacing for
100-Ohm PiR DPO Header Assemblies with PiC Right-Angle Receptacles**

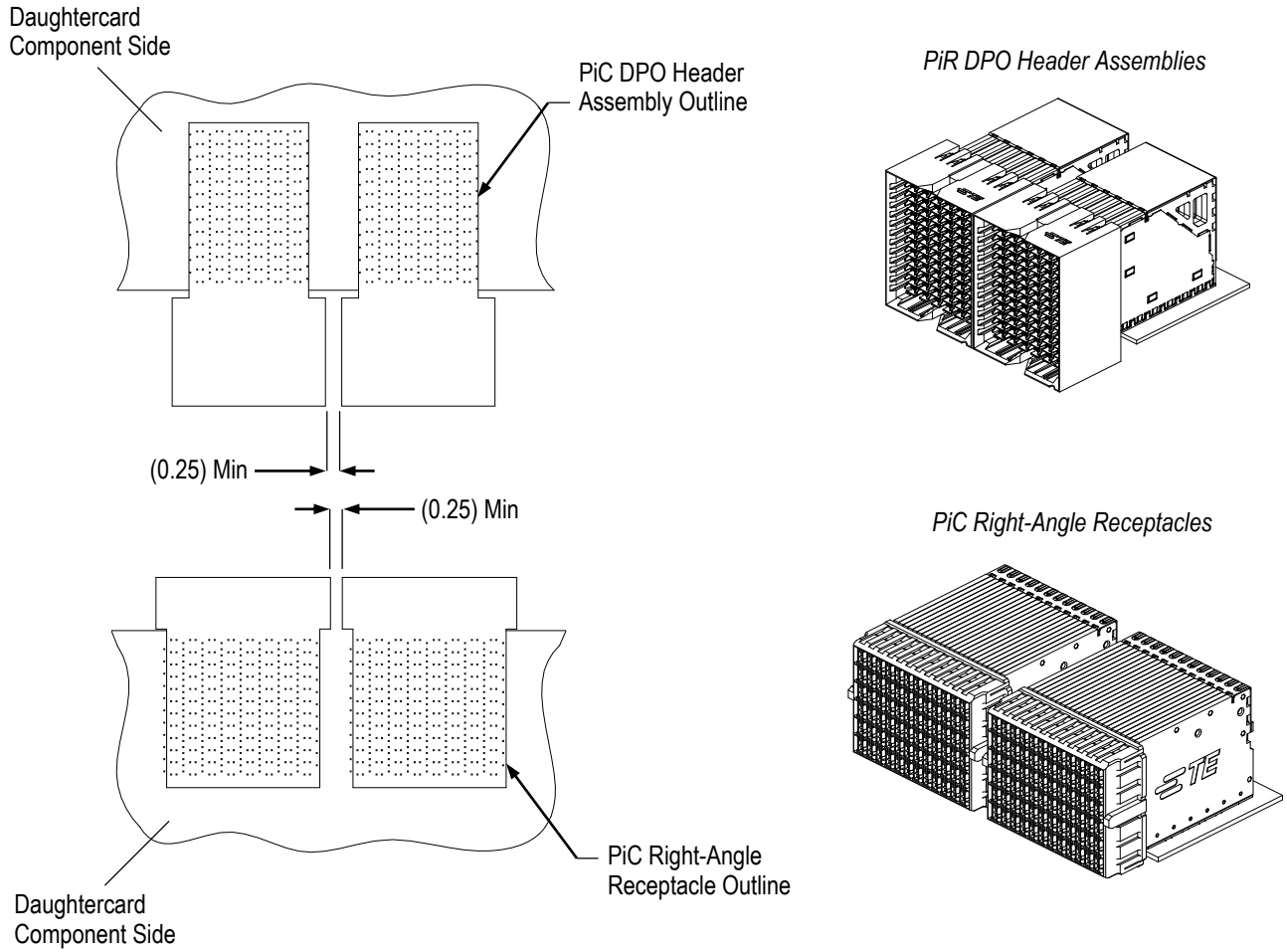

Figure 5 (End)

B. Guide Placement

Placement of the guides with the connectors on the pc board is shown in Figure 6.

The guide pins are designed to accommodate 0.3 of shrink to the pc board. Pick-up capability of guides is given in Figure 6.



NOTE

An excessively stiff pc board with bow might require a stiffener. For requirements, call *PRODUCT INFORMATION* at the number at the bottom of page 1.

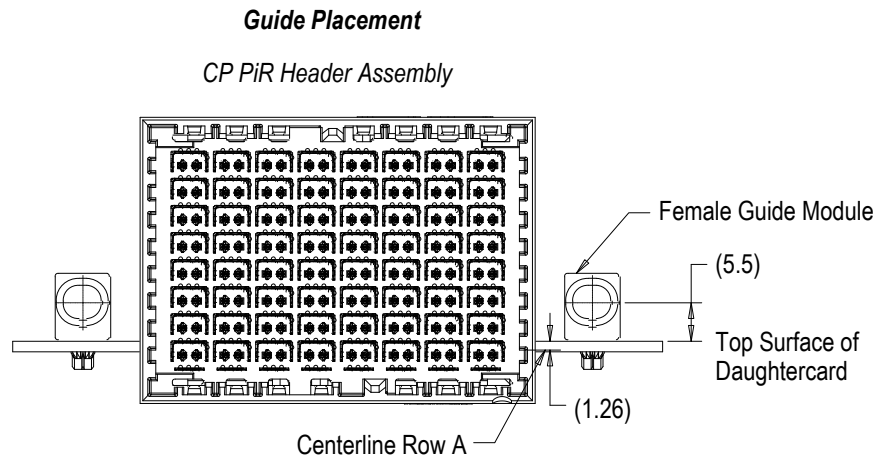

Mated Connectors Side-by-Side

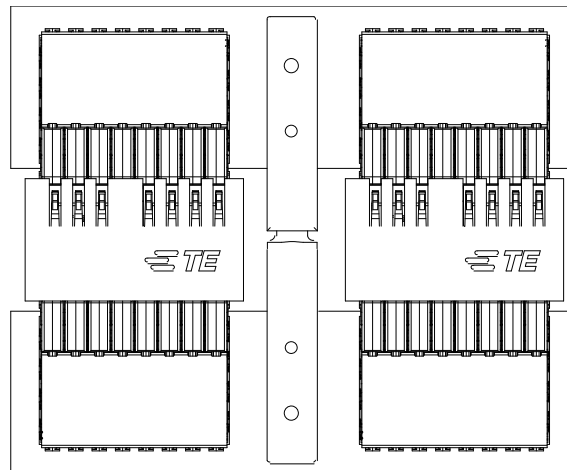
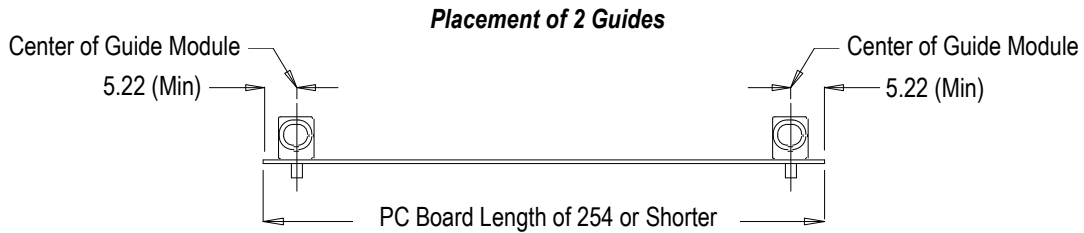

Figure 6 (Cont'd)



Note: For pc boards longer than 254, call PRODUCT INFORMATION at the number at the bottom of page 1.

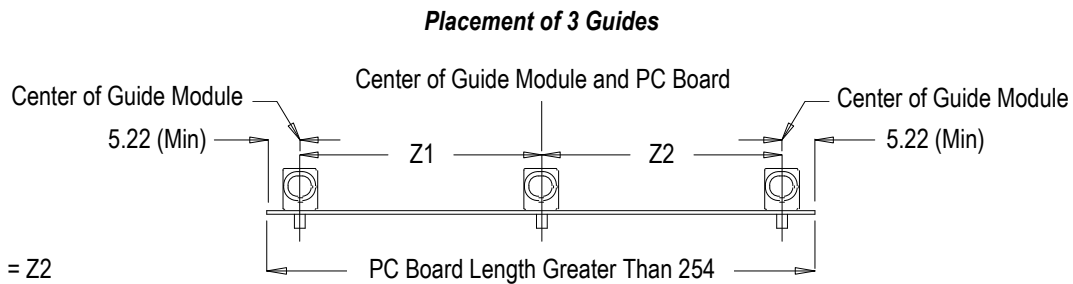

Figure 6 (End)

3.8. Installation

A. Guide Installation

Insertion of the guides into the pc boards must be applied with tooling capable of applying a downward pressure between 222 and 1112 N [50 and 250 lb-force.]. For pc boards having a thickness under 4.5, a pc board support must be used (refer to Section 5 for design details).

The guide pin and female guide module must be fully seated on the pc board. The guide module screw and guide pin screw each must be tight to a maximum torque of 1.01 Nm [9 in.-lbs].

Typical application of guide pin and female guide modules is shown in Figure 7.

Typically Applied Guide Pin and Female Guide Module for CP Connectors

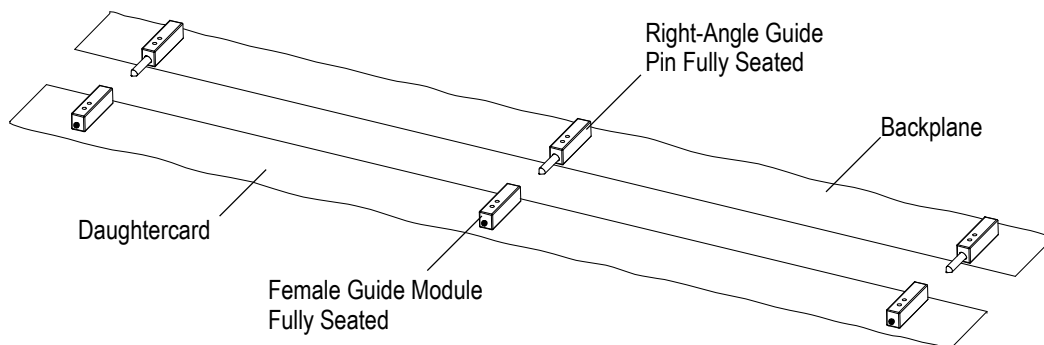

Note: PC Board Holes for Connectors Not Shown

Figure 7

B. Connector Installation

These connectors are typically applied to the pc board manually or using an automatic machine. Connectors should be gripped by the housing and/or chicklets only and not by the contacts.

When placing the header onto the pc board, all contact leads should be aligned and inserted into the pc board simultaneously to prevent twisting or bending of the contacts.

When manually placing the receptacle on the pc board, the row of contact leads closest to the pc board edge should be aligned first, then the remainder of the rows should be aligned by rolling the receptacle from front to back.

These connectors must be placed on the pc board so that Pin 1 to Position 1 orientation is maintained. After the connector is placed on the pc board, all contact tips must be within the pc board hole and the open portion of the contacts having the longest pin length must be inside the pc board hole as shown in Figure 8.

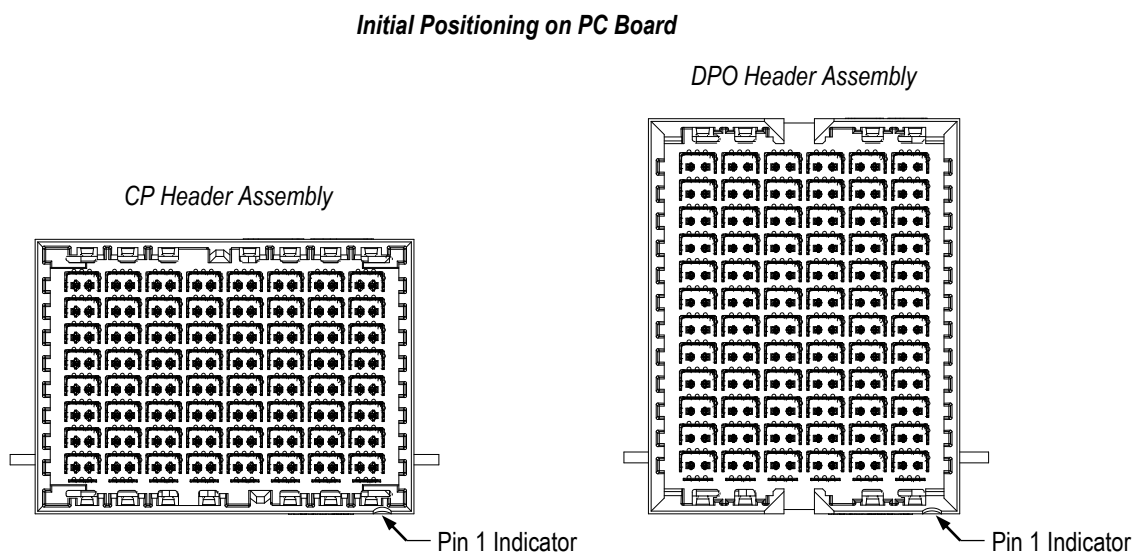

Figure 8

Seating force must be applied evenly on the connectors to prevent deformation or other damage to the contacts and housings. When installing the header, the insertion force must be evenly applied to the assembly using the appropriate seating tool. When installing the receptacle, the insertion force must be evenly applied to the assembly as shown in Figure 9.

Tooling used to seat these connectors must be capable of supplying a controllable downward force needed to seat the connector. Seating force will vary according to pc board variations and signal pin count. The average insertion force is 8.7 N [1.96 lb-force] per compliant pin press-fit contact. The maximum insertion force is 17.8 N [4.0 lb-force] per compliant pin press-fit contact.



NOTE

Correct seating of the connector is essential to interconnection performance. Over-seating of connectors will deform parts critical to the quality of the connector. Maximum force occurs prior to the connector bottoming on the pc board.

Headers and receptacles must be seated to the requirements given in Figure 9.

Seating Requirements

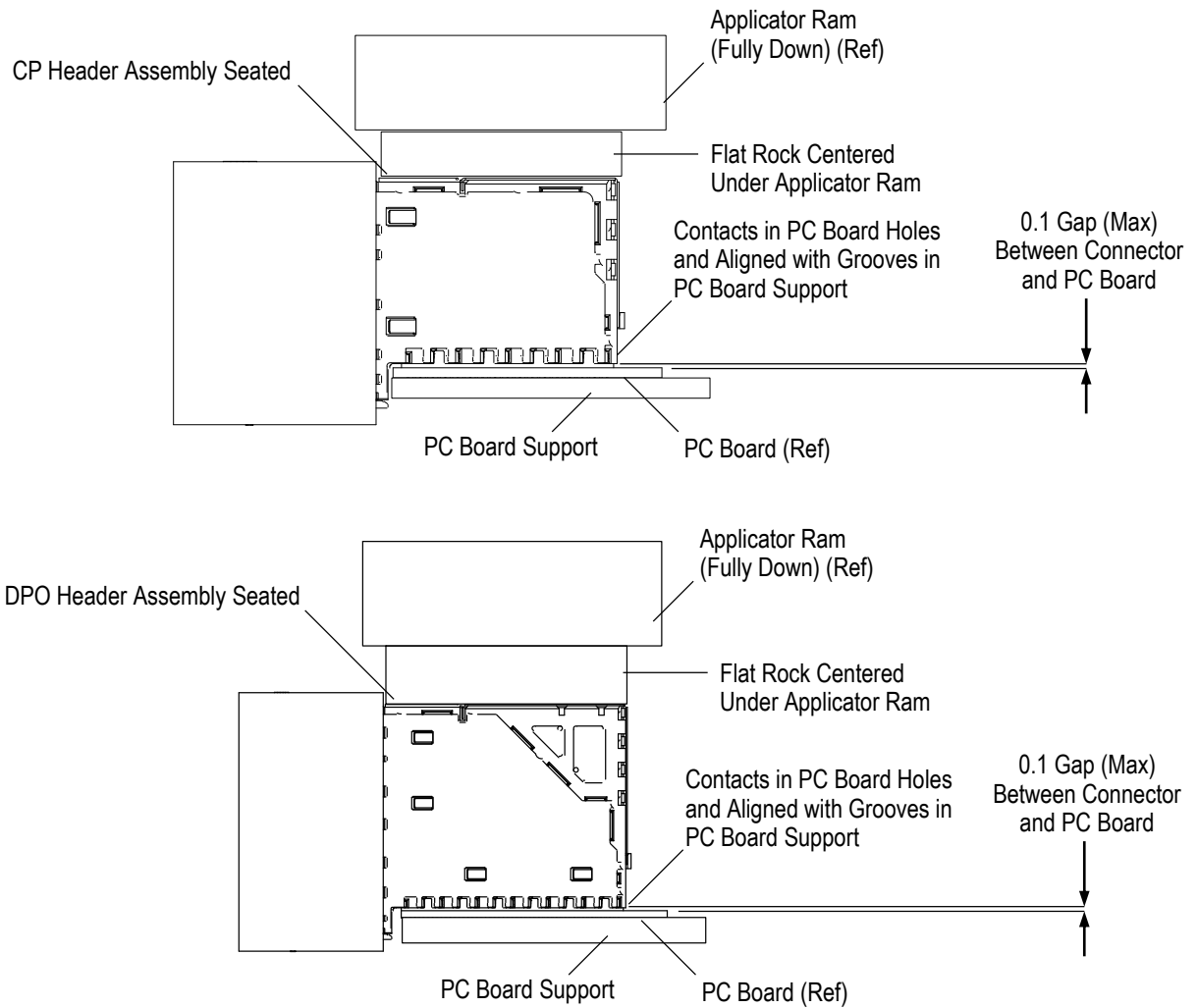

Figure 9

3.9. Mating

A. Alignment

Proper alignment is essential to ensure full engagement of mating connectors and to ensure that contacts are not bent or otherwise damaged during mating and unmating. Tolerance limitations are given in Figure 10.

Mating Alignment of CP and DPO Connectors

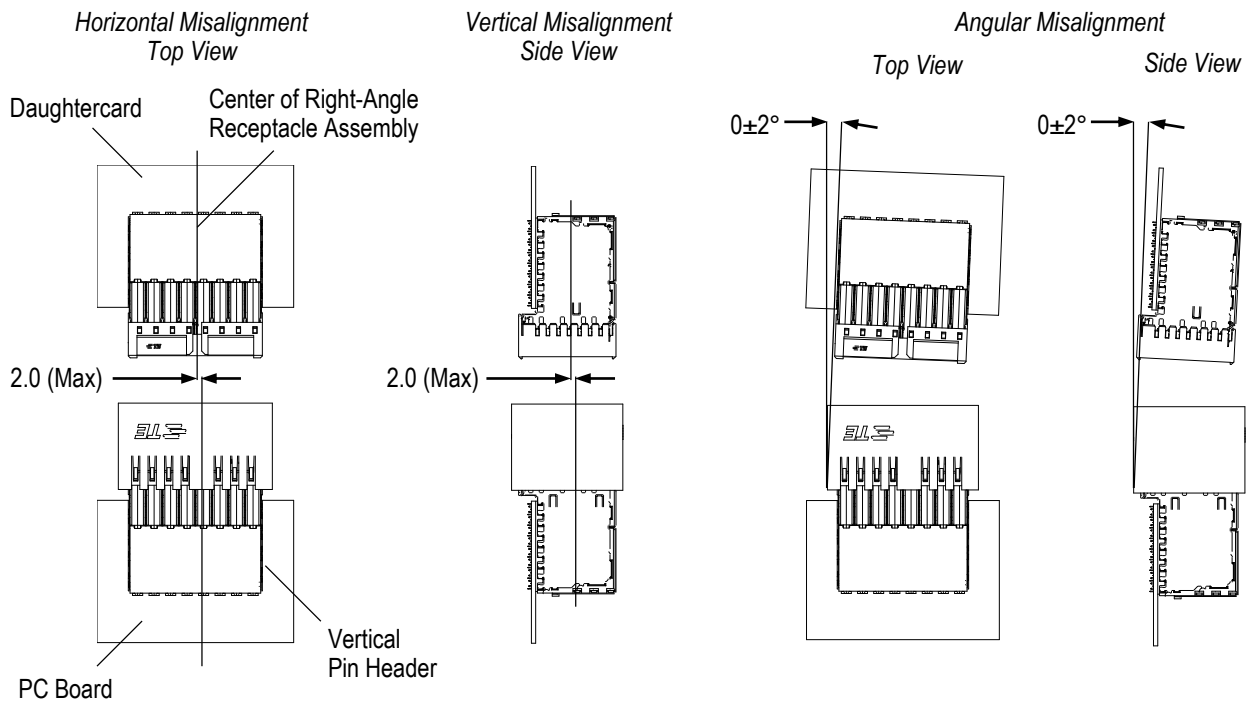

Figure 10

B. Sequences and Wipe Length

This connector system has 2 basic levels of sequencing during mating. The order of mating is: ground shield and signal pin. The relative distances between sequencing events as a function of the distance between the surface of the backplane and the centerline of the daughtercard connector Ref A2 pin is given in Figure 11.

Full mating of connectors is necessary to ensure a good connection and to obtain the maximum signal transmission performance. The dimension given for the fully mated condition from the surface of the backplane to the first row of contacts of the daughtercard connector is recommended; however, the maximum pull-out dimension given is acceptable. Refer to Figure 11.

Connector wipe length is calculated by subtracting the fully mated condition from the reliable mating point data. Wipe lengths are given in Figure 11.



NOTE

For circuit routing concerns or applications with sense pins, contact PRODUCT INFORMATION at the number at the bottom of page 1.

3.10. Guide Removal

A pc board support must be used when removing any guide pin or guide module. Refer to Section 5 for design requirements.

A. Guide Pin

Each guide pin can be removed from the pc board using tooling capable of applying downward pressure of 556 N [125 lb-force].

For external threaded guide pin, the nut must be removed, then downward pressure can be applied to the threads to remove the guide pin.

For internal threaded guide pin, the screw must be removed, a 3.5 diameter pin can be inserted into the screw hole, and then downward pressure can be applied to the pin to remove the guide pin.

Mating Sequences and Wipe Length

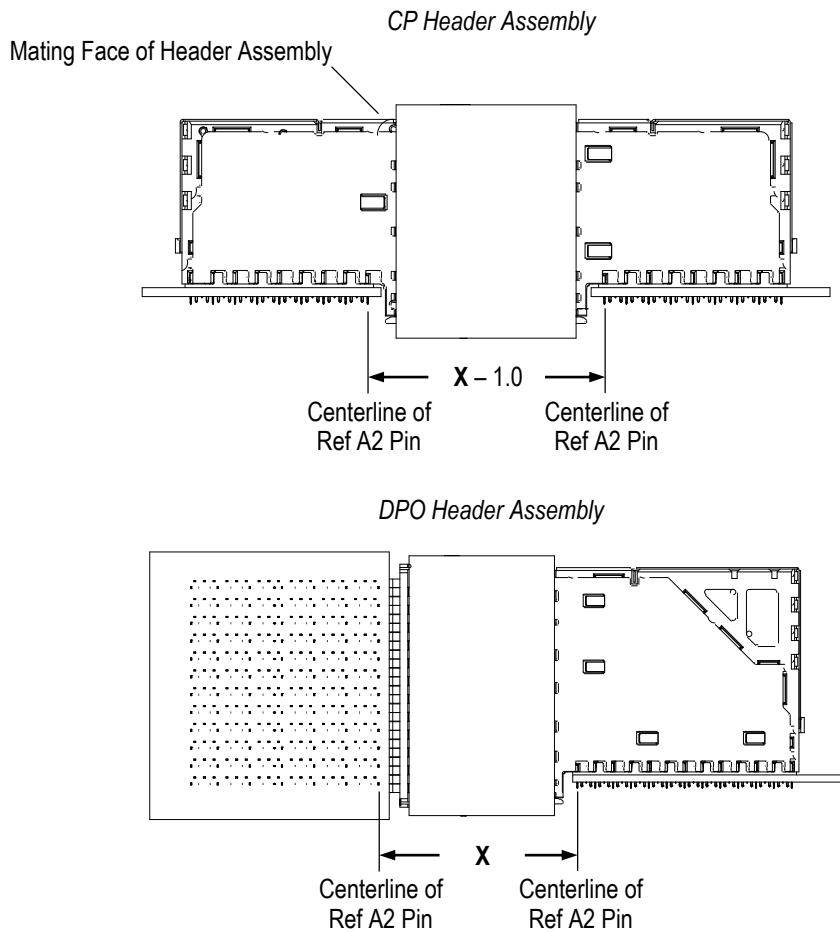

Note: The first mate, last break sequencing point is the first and last instance in a mating cycle where the pin comes in contact with the beam, but has not deflected the beam. The reliable mating point is the first and last instance in a mating cycle where the pin has completely deflected the beam and the beam is supplying full normal force to the pin.

CONTACT TYPE	DIMENSION X			FULLY MATED WIPE LENGTH
	Fully Mated	Reliable Mate	First Mate, Last Break	
Ground	27.75	30.99	31.40	3.24
Signal		30.25	30.65	2.50

Figure 11

B. Guide Module

Each guide module can be removed from the pc board using tooling capable of applying downward pressure of 333 N [75 lb-force].

3.11. Repair and Replacement

Damaged or defective connectors must not be used; they must be removed from the pc board and replaced.



CAUTION

To avoid damage to the connectors, ammonia should not be used in the removal process.

A. Rework

Even though this connector system uses press-in compliant pins and does not require solder, pc board repair or rework could require soldering after the connectors are inserted in the pc board; therefore, the following applies:

Ammonia must NOT be used for cleaning the assemblies. Material in the guide module and connector signal contacts will have a reaction to ammonia.

Air drying of cleaned connectors is recommended.

Gold surfaces of contact tines must be re-lubricated with a Telcordia-approved lubricant.



CAUTION

Even when using “no clean” solder paste, it is imperative that the contact interface be kept clean of flux and residue, since it acts as an insulator.



DANGER

Consideration must be given to toxicity and other safety requirements recommended by the solvent manufacturer. Refer to the manufacturer’s material safety data sheet (MSDS) for characteristics and handling of cleaners. Trichloroethylene and methylene chloride is not recommended because of harmful occupational and environmental effects. Both are carcinogenic (cancer-causing).

B. Replacement

Individual connector components cannot be replaced. For header assemblies that have any damaged or defective “C” ground shields, flat ground shields, or signal contacts, the right-angle receptacle and vertical plug must be separated by releasing the latches, and the damaged one replaced with a new one.

An entire connector can be removed from the pc board and replaced with a new one.

4. QUALIFICATIONS

3.9-mm pitch 85-ohm and 100-ohm CP and DPO STRADA Whisper connector system agency evaluation was not defined at the time of publication of this application specification.

5. TOOLING

Recommended tooling for application of these connectors is given in Figure 12.

5.1. Drilling Holes in PC Board

Recommended drill bits for drilling contact holes in the pc board are available from:

CONTACT HOLE DIAMETER	COMPANY AND DRILL BIT PART NUMBER	
		Carbide Related Technologies (CRT) 355 Sackett Point Road, Unit 5 North Haven, CT 06473 USA Phone: 203-281-1266 www.carbiderelatedtech.com
0.32	DSP0126L05A	H0320-DUS40030
0.42	DSP0165L05A	H0420-DUS40055



NOTE

Drill bits other than recommended may be used as long as the tolerance range is the same as that of the recommended drill.

5.2. PC Board Support

A pc board support must have minimum thickness of 1 and a flat surface with holes or a channel wide and deep enough to receive any protruding compliant pins and parts. A pc board support must be used:

- with pc boards having a thickness less than 2 to allow clearance for protruding contact tails
- during seating of a connector onto the pc board
- during removal of a guide pin or guide module from the pc board

5.3. Seating Tools and Removal Tools

A customer-designed flat rock must be used to seat the connectors.

The removal tool assembly for the PiR and PiC receptacles includes all of the tooling to remove a receptacle from the pc board. The tooling is designed to be used based on the receptacle size and position on the pc board.

5.4. Power Units

A power unit is an automatic or semi-automatic machine used to supply the force to seat the connector onto the pc board using seating tools. The power unit must have a ram and be capable of supplying a downward force needed to seat the connector. Typical power units from TE include, but are not limited to, the power units shown.

5.5. Manual Arbor Frame Assembly

Manual arbor frame assemblies are used to exert a downward force used to apply connectors to a pc board using seating tools. Commercially arbor frame assemblies are available.

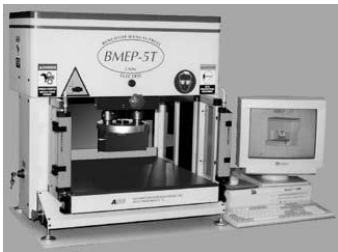

Model BMEP 5T Machine
1585696-1



Model MEP 6T Machine
1585699-1

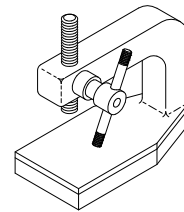

Manual Arbor Frame Assembly
(Commercially Available)

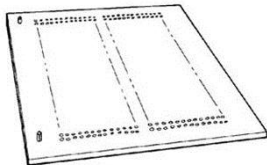

PC Board Support
(Customer Supplied)

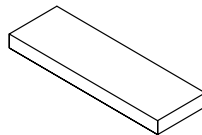

Flat Rock for Seating Connectors
(Customer Designed)

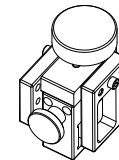

Removal Tool Assembly for Receptacles
(For Part Numbers, Contact TOOLING ASSISTANCE CENTER at Number at Bottom of Page 1)

Figure 12

6. VISUAL AID

The illustration below shows a typical application of 3.9-mm pitch 85-ohm and 100-ohm CP and DPO STRADA Whisper connector system. This illustration should be used by production personnel to ensure a correctly applied product. Applications which DO NOT appear correct should be inspected using the information in the preceding pages of this specification and in the instructional material shipped with the product or tooling.

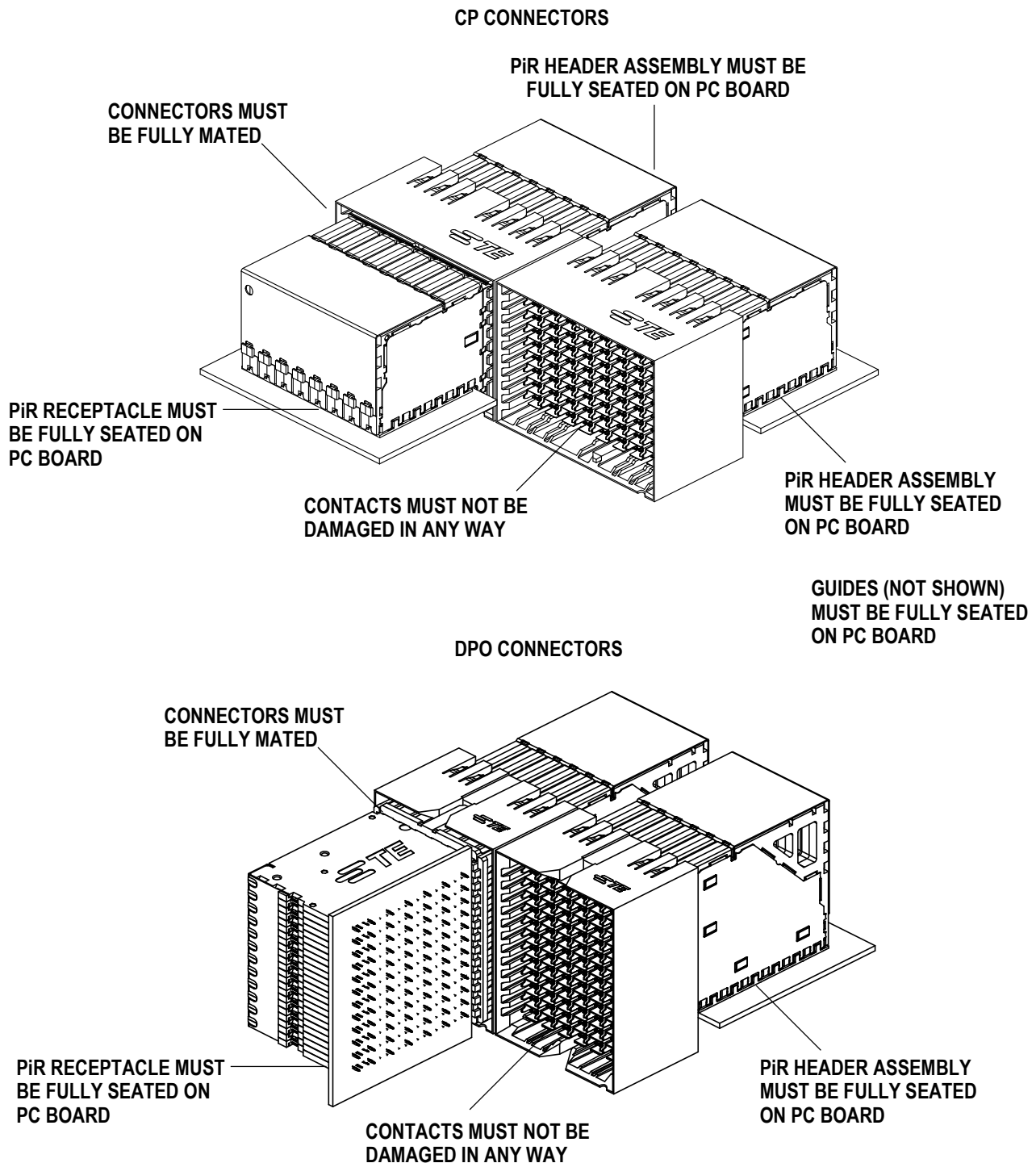

FIGURE 13. VISUAL AID



Стандарт Электрон Связь

Мы молодая и активно развивающаяся компания в области поставок электронных компонентов. Мы поставляем электронные компоненты отечественного и импортного производства напрямую от производителей и с крупнейших складов мира.

Благодаря сотрудничеству с мировыми поставщиками мы осуществляем комплексные и плановые поставки широчайшего спектра электронных компонентов.

Собственная эффективная логистика и склад в обеспечивает надежную поставку продукции в точно указанные сроки по всей России.

Мы осуществляем техническую поддержку нашим клиентам и предпродажную проверку качества продукции. На все поставляемые продукты мы предоставляем гарантию .

Осуществляем поставки продукции под контролем ВП МО РФ на предприятия военно-промышленного комплекса России , а также работаем в рамках 275 ФЗ с открытием отдельных счетов в уполномоченном банке. Система менеджмента качества компании соответствует требованиям ГОСТ ISO 9001.

Минимальные сроки поставки, гибкие цены, неограниченный ассортимент и индивидуальный подход к клиентам являются основой для выстраивания долгосрочного и эффективного сотрудничества с предприятиями радиоэлектронной промышленности, предприятиями ВПК и научно-исследовательскими институтами России.

С нами вы становитесь еще успешнее!

Наши контакты:

Телефон: +7 812 627 14 35

Электронная почта: sales@st-electron.ru

Адрес: 198099, Санкт-Петербург,
Промышленная ул, дом № 19, литера Н,
помещение 100-Н Офис 331