



SERIES: SDM36-UD | **DESCRIPTION:** AC-DC POWER SUPPLY

FEATURES

- up to 36 W continuous power
- meets DoE Level VI efficiency
- universal input voltage range
- compact size
- no load power consumption < 0.10 W
- over voltage and short circuit protections
- UL/cUL, TUV, and PSE safety approvals
- LED indicator
- custom designs available



MODEL	output voltage (Vdc)	output current max (A)	output power max (W)	ripple and noise ¹ max (mVp-p)	efficiency level
SDM36-5-UD	5	5	25	80	VI
SDM36-7.5-UD	7.5	4	30	80	VI
SDM36-9-UD	9	4	36	90	VI
SDM36-12-UD	12	3	36	120	VI
SDM36-15-UD	15	2.4	36	150	VI
SDM36-18-UD	18	2	36	180	VI
SDM36-24-UD	24	1.5	36	240	VI

Notes: 1. At full load, nominal input, 20 MHz bandwidth oscilloscope, output terminated with 0.1 μF multilayer ceramic and 10 μF low ESR electrolytic capacitors.

PART NUMBER KEY

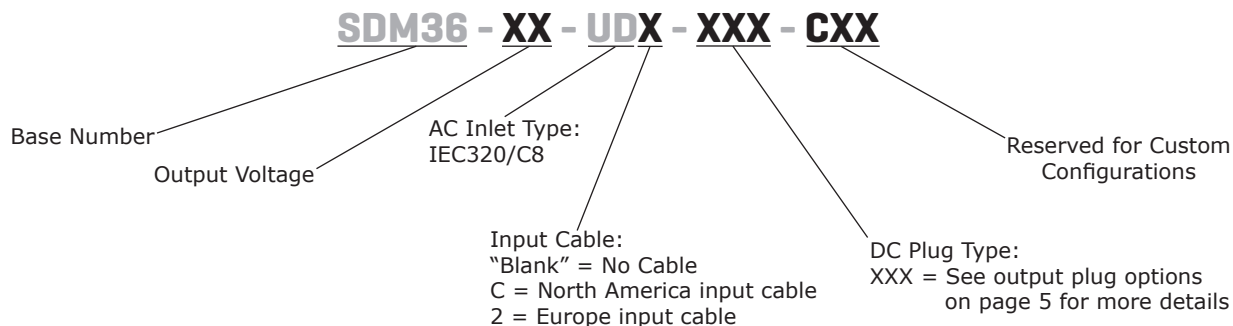

INPUT

parameter	conditions/description	min	typ	max	units
voltage		90		264	Vac
frequency		47		63	Hz
current				1	A
inrush current	at 230 Vac, full load, 25°C, cold start			70	A
leakage current				0.1	mA
no load power consumption	at 230 Vac			0.10	W

OUTPUT

parameter	conditions/description	min	typ	max	units
regulation	5 Vdc model all other models		±6 ±5		% %

PROTECTIONS

parameter	conditions/description	min	typ	max	units
over voltage protection	output shut down			200	%
over current protection	output shut down, auto recovery			200	%
short circuit protection	output shut down, auto recovery				

SAFETY & COMPLIANCE

parameter	conditions/description	min	typ	max	units
isolation voltage	input to output at 10 mA for 1 minute		4,000		Vac
isolation resistance	input to output at 500 Vdc	10			MΩ
safety approvals	Medical: UL/cUL, TUV ITE: PSE				
EMI/EMC	FCC Part 15B Class B, CE				
MTBF	as per Telcordia SR-332, 25°C	300,000			hours
RoHS	2011/65/EU				

ENVIRONMENTAL

parameter	conditions/description	min	typ	max	units
operating temperature		0		40	°C
storage temperature		-20		80	°C
operating humidity	non-condensing	20		80	%
storage humidity	non-condensing	10		90	%

MECHANICAL

parameter	conditions/description	min	typ	max	units
dimensions	99 x 50 x 33				mm
inlet plug	IEC320/C8				
weight	without ac cord		210		g

MECHANICAL DRAWING

units: mm
tolerance: ±1.0 mm

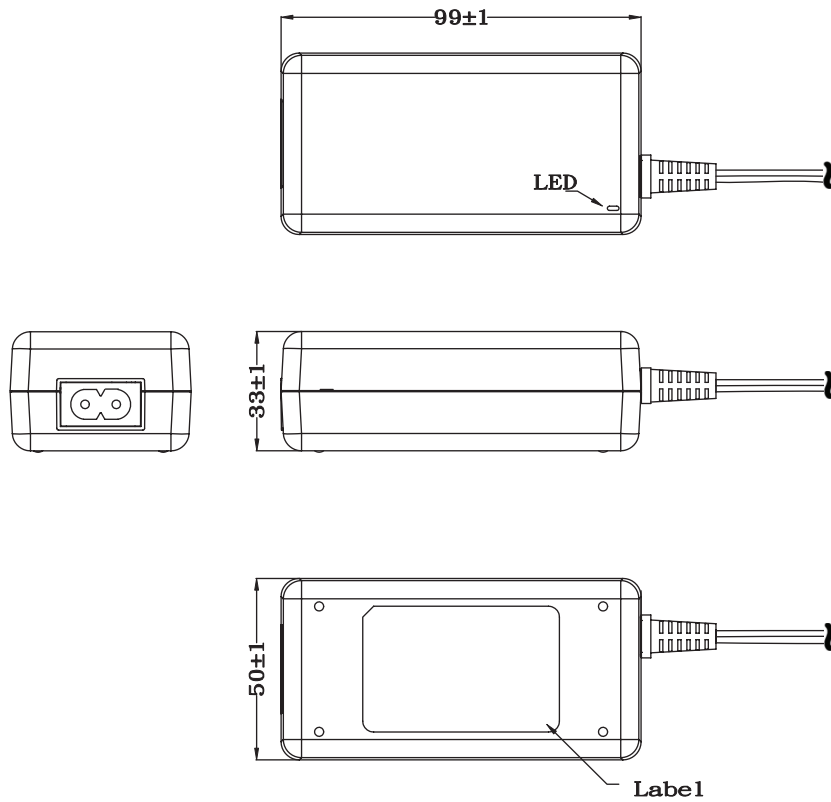

DC CORD

units: mm

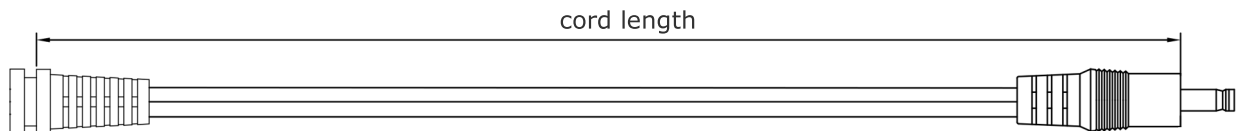

Table 1

MODEL NO.	CABLE	CORD LENGTH
SDM36-5-UD	UL2468, 16 AWG	1,500 mm ±30
SDM36-7.5-UD	UL2468, 18 AWG	1,500 mm ±30
SDM36-9-UD	UL2468, 18 AWG	1,500 mm ±30
SDM36-12-UD	UL2468, 18 AWG	1,500 mm ±30
SDM36-15-UD	UL2468, 18 AWG	1,500 mm ±30
SDM36-18-UD	UL2468, 20 AWG	1,500 mm ±30
SDM36-24-UD	UL2468, 20 AWG	1,500 mm ±30

AC CORDS

units: mm

NORTH AMERICA

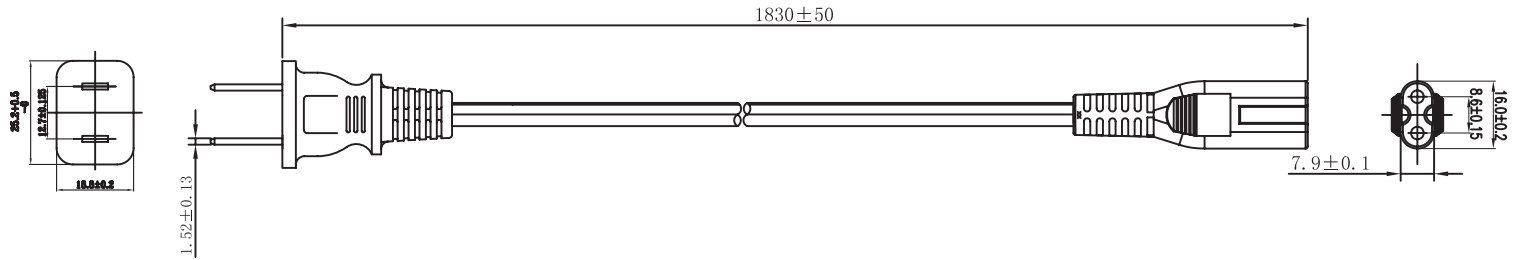

EUROPE

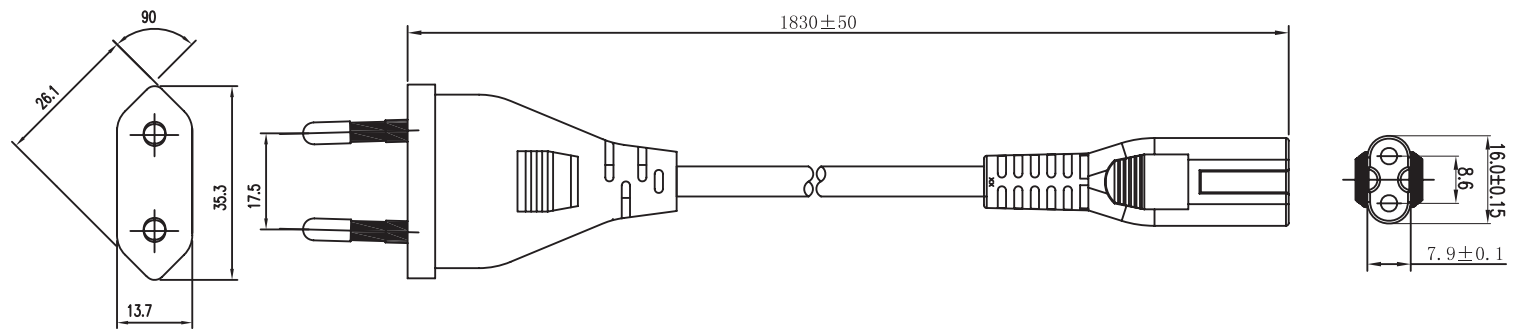

DC PLUG TYPE PART NUMBER KEY

XXX

Plug Polarity:
P = Center Positive
N = Center Negative

Plug Code:
X = Choose a code from the options below

Plug Angle:
"blank" = Straight
R = Right Angle

Plug Polarity		Code		Dimensions (mm)			Plug Angle	
Center Pos.	Center Neg.	Option	Type	A	B	C	Straight	Right
•	•	5	Standard	5.5	2.1	9.5	•	•
•	•	6	Standard	5.5	2.5	9.5	•	•
•	•	7	Standard	3.5	1.35	9.5	•	•
•	•	8	Standard	3.8	1.35	9.5	•	•
•	•	9	Standard	3.8	1.05	9.5	•	•
•	•	10	Locking	5.5	2.1	9.5	•	N/A
•	•	11	Locking	5.5	2.5	9.5	•	N/A
•	•	12	EIAJ-1	2.35	0.7	9.5	•	•
•	•	13	EIAJ-2	4.0	1.7	9.5	•	•
•	•	14	EIAJ-3	4.75	1.7	9.5	•	•
N/A	N/A	ST	Stripped & Tinned				N/A	N/A
N/A	N/A	MUB	USB	Micro USB Type B			•	N/A

Note: 1. Contact CUI for additional plug options

Standard

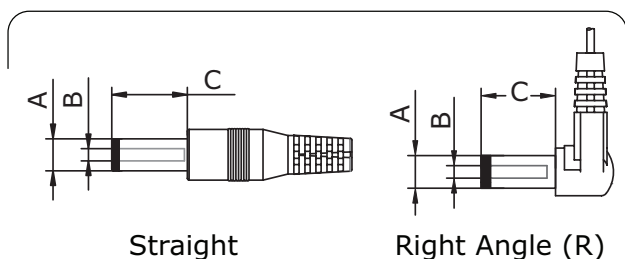

EIAJ

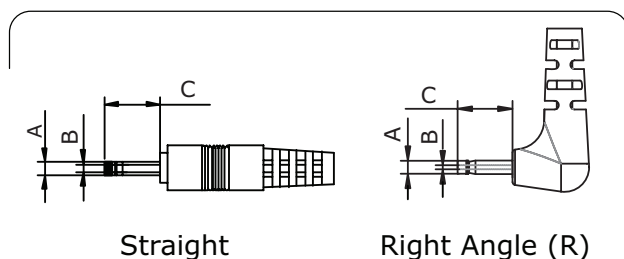

Locking

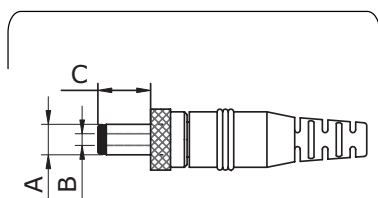

Stripped & Tinned

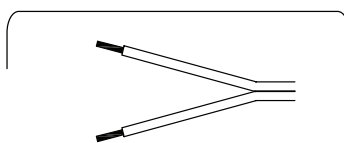

USB



REVISION HISTORY

rev.	description	date
1.0	initial release	01/29/2018

The revision history provided is for informational purposes only and is believed to be accurate.

**CUI INC**[®]

Headquarters
20050 SW 112th Ave.
Tualatin, OR 97062
800.275.4899

Fax 503.612.2383
cui.com
techsupport@cui.com

This device complies with part 15 of the FCC Rules. Operation is subject to the following two conditions:

- (1) This device may not cause harmful interference, and
- (2) this device must accept any interference received, including interference that may cause undesired operation.

CUI offers a one (1) year limited warranty. Complete warranty information is listed on our website.

CUI reserves the right to make changes to the product at any time without notice. Information provided by CUI is believed to be accurate and reliable. However, no responsibility is assumed by CUI for its use, nor for any infringements of patents or other rights of third parties which may result from its use.

CUI products are not authorized or warranted for use as critical components in equipment that requires an extremely high level of reliability. A critical component is any component of a life support device or system whose failure to perform can be reasonably expected to cause the failure of the life support device or system, or to affect its safety or effectiveness.



Стандарт Электрон Связь

Мы молодая и активно развивающаяся компания в области поставок электронных компонентов. Мы поставляем электронные компоненты отечественного и импортного производства напрямую от производителей и с крупнейших складов мира.

Благодаря сотрудничеству с мировыми поставщиками мы осуществляем комплексные и плановые поставки широчайшего спектра электронных компонентов.

Собственная эффективная логистика и склад в обеспечивает надежную поставку продукции в точно указанные сроки по всей России.

Мы осуществляем техническую поддержку нашим клиентам и предпродажную проверку качества продукции. На все поставляемые продукты мы предоставляем гарантию .

Осуществляем поставки продукции под контролем ВП МО РФ на предприятия военно-промышленного комплекса России , а также работаем в рамках 275 ФЗ с открытием отдельных счетов в уполномоченном банке. Система менеджмента качества компании соответствует требованиям ГОСТ ISO 9001.

Минимальные сроки поставки, гибкие цены, неограниченный ассортимент и индивидуальный подход к клиентам являются основой для выстраивания долгосрочного и эффективного сотрудничества с предприятиями радиоэлектронной промышленности, предприятиями ВПК и научно-исследовательскими институтами России.

С нами вы становитесь еще успешнее!

Наши контакты:

Телефон: +7 812 627 14 35

Электронная почта: sales@st-electron.ru

Адрес: 198099, Санкт-Петербург,
Промышленная ул, дом № 19, литера Н,
помещение 100-Н Офис 331