

High Speed Synchronous N-Channel MOSFET Drivers

FEATURES

- Wide V_{CC} Range: 6V to 9.5V
- 38V Maximum Input Supply Voltage
- Adaptive Shoot-Through Protection
- 2.4A Peak Pull-Up Current
- 5A Peak Pull-Down Current
- 8ns TG Fall Time Driving 3000pF Load
- 12ns TG Rise Time Driving 3000pF Load
- Separate Supply to Match PWM Controller
- Drives Dual N-Channel MOSFETs
- Undervoltage Lockout
- Thermally Enhanced MSOP Package

APPLICATIONS

- Distributed Power Architectures
- High Density Power Modules

DESCRIPTION

The LTC[®]4442 is a high frequency gate driver designed to drive two N-channel MOSFETs in a synchronous buck DC/DC converter topology. The powerful driver capability reduces switching losses in MOSFETs with high gate capacitance.

The LTC4442 features a separate supply for the input logic to match the signal swing of the controller IC. If the input signal is not being driven, the LTC4442 activates a shutdown mode that turns off both external MOSFETs. The input logic signal is internally level-shifted to the bootstrapped supply, which may function at up to 42V above ground.

The LTC4442 contains undervoltage lockout circuits on both the driver and logic supplies that turn off the external MOSFETs when an undervoltage condition is present. The LTC4442 and LTC4442-1 have different undervoltage lockout thresholds to accommodate a wide variety of applications. An adaptive shoot-through protection feature is also built-in to prevent power loss resulting from MOSFET cross-conduction current.

The LTC4442/LTC4442-1 are available in the thermally enhanced 8-lead MSOP package.

LT, LT, LTC, LTM, Linear Technology and the Linear logo are registered trademarks of Linear Technology Corporation. All other trademarks are the property of their respective owners.

TYPICAL APPLICATION

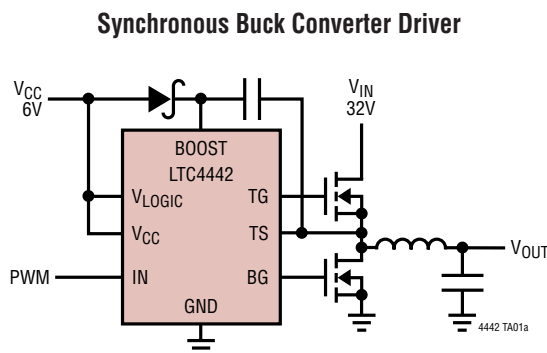

LTC4442 Driving 3000pF Capacitive Loads

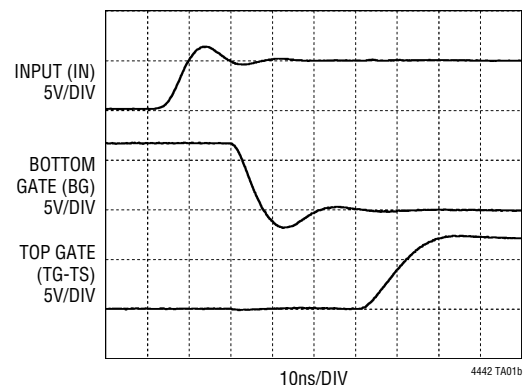

LTC4442/LTC4442-1

ABSOLUTE MAXIMUM RATINGS

(Note 1)

Supply Voltage

V_{CC}	-0.3V to 10V
V_{LOGIC}	-0.3V to 10V
BOOST – TS	-0.3V to 10V
IN Voltage	-0.3V to 10V
BOOST Voltage	-0.3V to 42V
TS Voltage	-5V to 38V
TS + V_{CC}	42V
Driver Output TG (with Respect to TS)	-0.3V to 10V
Driver Output BG	-0.3V to 10V
Operating Temperature Range (Note 2)	-40°C to 85°C
Junction Temperature (Note 3)	125°C
Storage Temperature Range	-65°C to 150°C
Lead Temperature (Soldering, 10 sec)	300°C

PIN CONFIGURATION

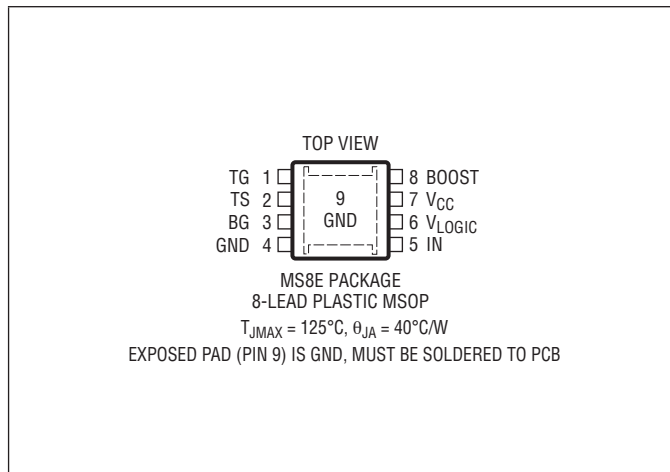

ORDER INFORMATION

LEAD FREE FINISH	TAPE AND REEL	PART MARKING*	PACKAGE DESCRIPTION	TEMPERATURE RANGE
LTC4442EMS8E#PBF	LTC4442EMS8E#TRPBF	LTCTJ	8-Lead Plastic MSOP	-40°C to 85°C
LTC4442IMS8E#PBF	LTC4442IMS8E#TRPBF	LTCTJ	8-Lead Plastic MSOP	-40°C to 85°C
LTC4442EMS8E-1#PBF	LTC4442EMS8E-1#TRPBF	LTCXR	8-Lead Plastic MSOP	-40°C to 85°C
LTC4442IMS8E-1#PBF	LTC4442IMS8E-1#TRPBF	LTCXR	8-Lead Plastic MSOP	-40°C to 85°C

Consult LTC Marketing for parts specified with wider operating temperature ranges. *The temperature grade is identified by a label on the shipping container. Consult LTC Marketing for information on non-standard lead based finish parts.

For more information on lead free part marking, go to: <http://www.linear.com/leadfree/>

For more information on tape and reel specifications, go to: <http://www.linear.com/tapeandree/>

ELECTRICAL CHARACTERISTICS

The ● denotes the specifications which apply over the full operating temperature range, otherwise specifications are at T_A = 25°C. V_{CC} = V_{BOOST} = 7V, V_{TS} = GND = 0V, V_{LOGIC} = 5V, unless otherwise noted.

SYMBOL	PARAMETER	CONDITIONS	MIN	TYP	MAX	UNITS
Logic Supply (V_{LOGIC})						
V _{LOGIC}	Operating Range		3		9.5	V
I _{VLOGIC}	DC Supply Current	IN = Floating		730	850	μA
UVLO	Undervoltage Lockout Threshold	V _{LOGIC} Rising	● 2.5	2.75	3.0	V
		V _{LOGIC} Falling	● 2.4	2.65	2.9	V
		Hysteresis		100		mV
Gate Driver Supply (V_{CC})						
V _{CC}	Operating Range		6		9.5	V
I _{VCC}	DC Supply Current	IN = Floating		300	380	μA

ELECTRICAL CHARACTERISTICS

The ● denotes the specifications which apply over the full operating temperature range, otherwise specifications are at $T_A = 25^\circ\text{C}$. $V_{CC} = V_{BOOST} = 7\text{V}$, $V_{TS} = \text{GND} = 0\text{V}$, $V_{LOGIC} = 5\text{V}$, unless otherwise noted.

SYMBOL	PARAMETER	CONDITIONS	MIN	TYP	MAX	UNITS
UVLO	Undervoltage Lockout Threshold	V_{CC} Rising (LTC4442)	● 2.75	3.20	3.65	V
		V_{CC} Falling (LTC4442)	● 2.60	3.04	3.50	V
		Hysteresis (LTC4442)			160	mV
		V_{CC} Rising (LTC4442-1)	● 5.6	6.2	6.7	V
		V_{CC} Falling (LTC4442-1)	● 4.7	5.3	5.8	V
		Hysteresis (LTC4442-1)		850		mV
Bootstrapped Supply (BOOST – TS)						
I_{BOOST}	DC Supply Current	IN = Floating		325	400	μA
Input Signal (IN)						
$V_{IH(TG)}$	TG Turn-On Input Threshold	$V_{LOGIC} \geq 5\text{V}$, IN Rising	● 3.0	3.5	4.0	V
		$V_{LOGIC} = 3.3\text{V}$, IN Rising	● 1.9	2.2	2.6	V
$V_{IL(TG)}$	TG Turn-Off Input Threshold	$V_{LOGIC} \geq 5\text{V}$, IN Falling		3.25		V
		$V_{LOGIC} = 3.3\text{V}$, IN Falling		2.09		V
$V_{IH(BG)}$	BG Turn-On Input Threshold	$V_{LOGIC} \geq 5\text{V}$, IN Falling	● 0.8	1.25	1.6	V
		$V_{LOGIC} = 3.3\text{V}$, IN Falling	● 0.8	1.10	1.4	V
$V_{IL(BG)}$	BG Turn-Off Input Threshold	$V_{LOGIC} \geq 5\text{V}$, IN Rising		1.50		V
		$V_{LOGIC} = 3.3\text{V}$, IN Rising		1.21		V
$I_{IN(SD)}$	Maximum Current Into or Out of IN in Shutdown Mode	$V_{LOGIC} \geq 5\text{V}$, IN Floating		200	300	μA
		$V_{LOGIC} = 3.3\text{V}$, IN Floating		100	150	μA
High Side Gate Driver Output (TG)						
$V_{OH(TG)}$	TG High Output Voltage	$I_{TG} = -10\text{mA}$, $V_{OH(TG)} = V_{BOOST} - V_{TG}$		0.7		V
$V_{OL(TG)}$	TG Low Output Voltage	$I_{TG} = 100\text{mA}$, $V_{OL(TG)} = V_{TG} - V_{TS}$		100		mV
$I_{PU(TG)}$	TG Peak Pull-Up Current		● 1.5	2.4		A
$I_{PD(TG)}$	TG Peak Pull-Down Current		● 1.5	2.4		A
Low Side Gate Driver Output (BG)						
$V_{OH(BG)}$	BG High Output Voltage	$I_{BG} = -10\text{mA}$, $V_{OH(BG)} = V_{CC} - V_{BG}$		0.7		V
$V_{OL(BG)}$	BG Low Output Voltage	$I_{BG} = 100\text{mA}$		100		mV
$I_{PU(BG)}$	BG Peak Pull-Up Current		● 1.4	2.4		A
$I_{PD(BG)}$	BG Peak Pull-Down Current		● 3.5	5.0		A
Switching Time						
$t_{PLH(TG)}$	BG Low to TG High Propagation Delay			20		ns
$t_{PHL(TG)}$	IN Low to TG Low Propagation Delay			12		ns
$t_{PLH(BG)}$	TG Low to BG High Propagation Delay			20		ns
$t_{PHL(BG)}$	IN High to BG Low Propagation Delay			12		ns
$t_r(TG)$	TG Output Rise Time	10% – 90%, $C_L = 3\text{nF}$		12		ns
$t_f(TG)$	TG Output Fall Time	10% – 90%, $C_L = 3\text{nF}$		8		ns
$t_r(BG)$	BG Output Rise Time	10% – 90%, $C_L = 3\text{nF}$		12		ns
$t_f(BG)$	BG Output Fall Time	10% – 90%, $C_L = 3\text{nF}$		5		ns

Note 1: Stresses beyond those listed under Absolute Maximum Ratings may cause permanent damage to the device. Exposure to any Absolute Maximum Rating condition for extended periods may affect device reliability and lifetime.

Note 2: The LTC4442/LTC4442-1 are guaranteed to meet specifications from -40°C to 85°C . The LTC4442E/LTC4442E-1 are guaranteed to meet specifications from 0°C to 85°C with specifications over the -40°C to 85°C operating temperature range assured by design, characterization and correlation with statistical process controls.

T_J is calculated from the ambient temperature T_A and power dissipation P_D according to the following formula:

$$T_J = T_A + (P_D \cdot \theta_{JA}^\circ\text{C/W})$$

Note 3: This IC includes overtemperature protection that is intended to protect the device during momentary overload conditions. Junction temperature will exceed 125°C when overtemperature protection is active. Continuous operation above the specified maximum operating junction temperature may impair device reliability.

TYPICAL PERFORMANCE CHARACTERISTICS

Input Thresholds vs V_{LOGIC} Supply Voltage

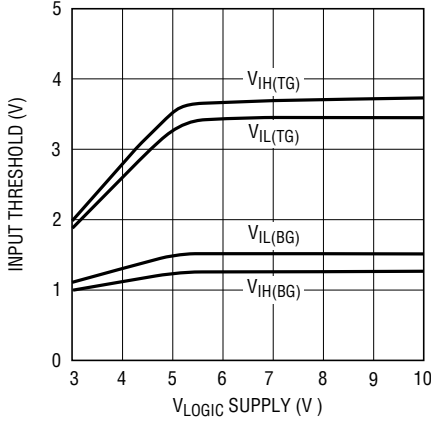

Input Thresholds for $V_{\text{LOGIC}} = 3.3\text{V}$ vs Temperature

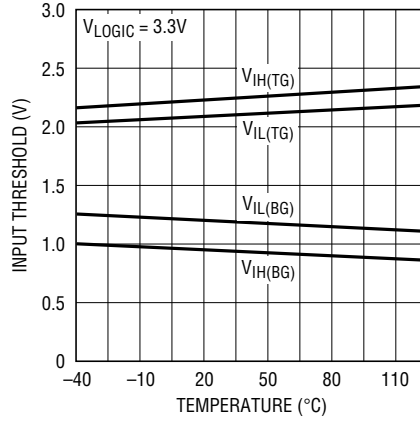

Input Thresholds for $V_{\text{LOGIC}} \geq 5\text{V}$ vs Temperature

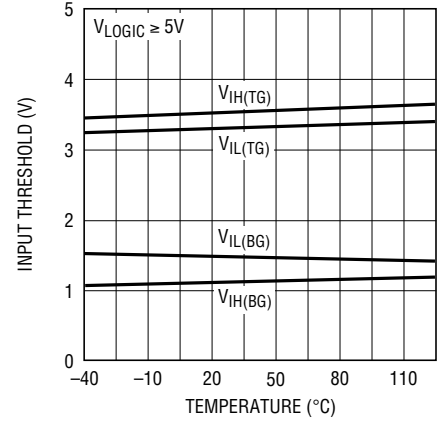

BG or TG Input Threshold Hysteresis vs V_{LOGIC} Supply Voltage

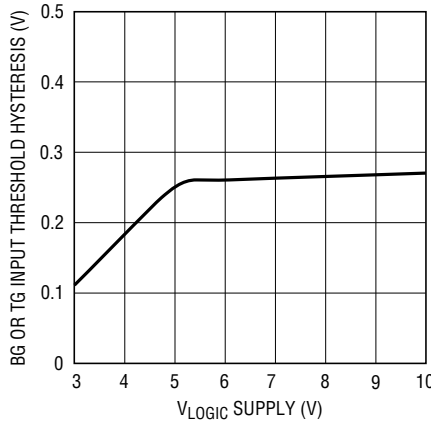

BG or TG Input Threshold Hysteresis vs Temperature

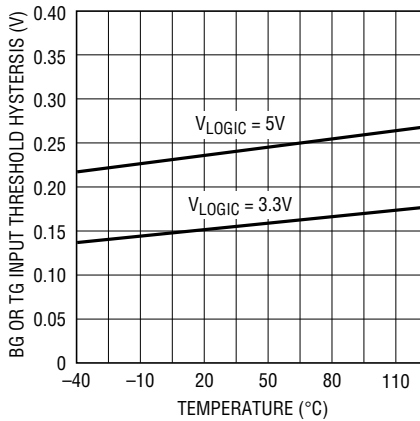

Quiescent Supply Current vs Supply Voltage

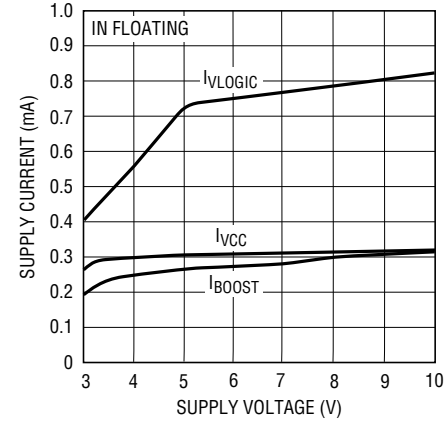

Quiescent Supply Current vs Temperature

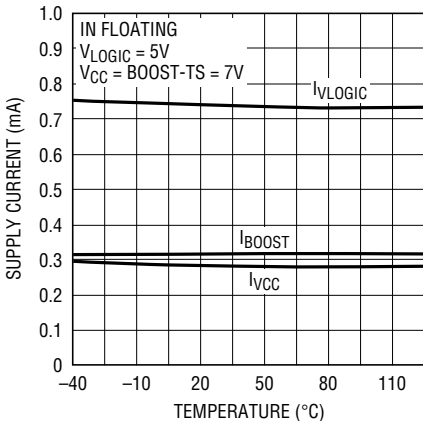

V_{LOGIC} Undervoltage Lockout Thresholds vs Temperature

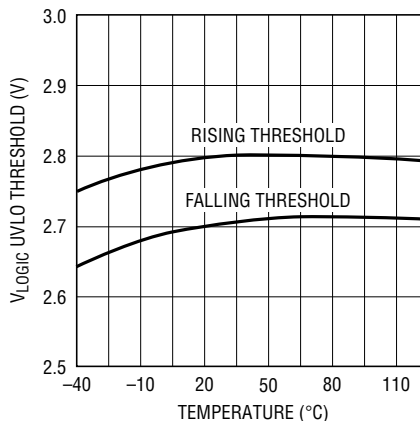

V_{CC} Undervoltage Lockout Thresholds vs Temperature

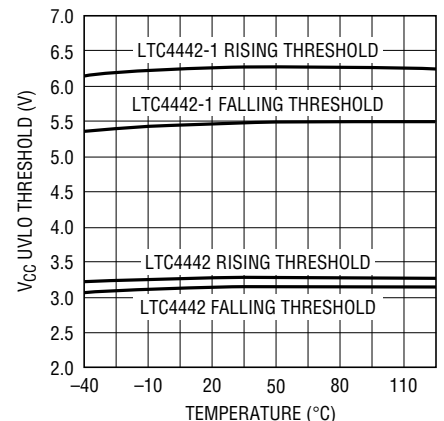

TYPICAL PERFORMANCE CHARACTERISTICS

Undervoltage Lockout Threshold Hysteresis vs Temperature

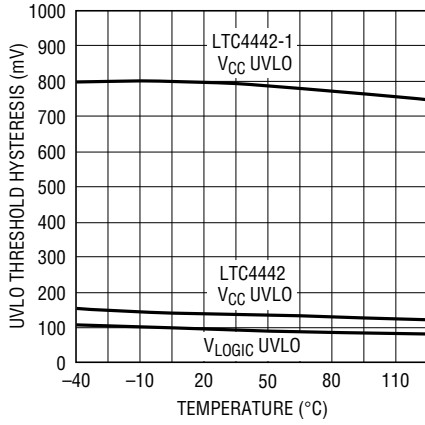

4442 G10

Switching Supply Current vs Input Frequency

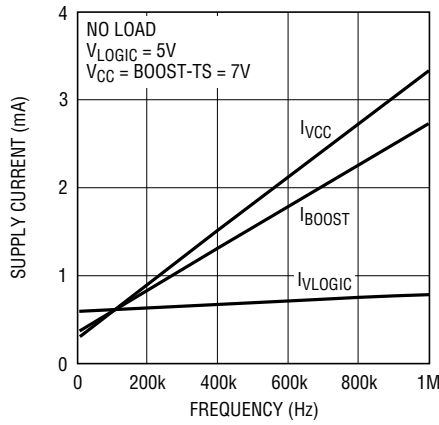

4442 G11

Switching Supply Current vs Load Capacitance

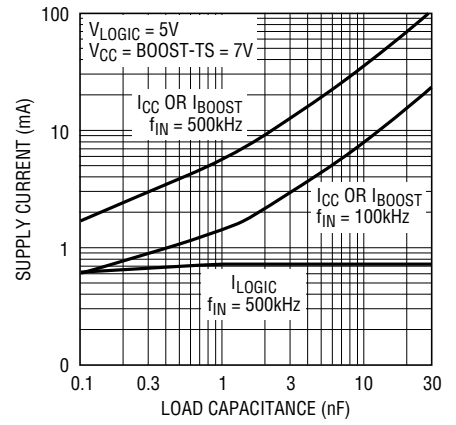

4442 G12

Propagation Delay vs V_{LOGIC} Supply Voltage

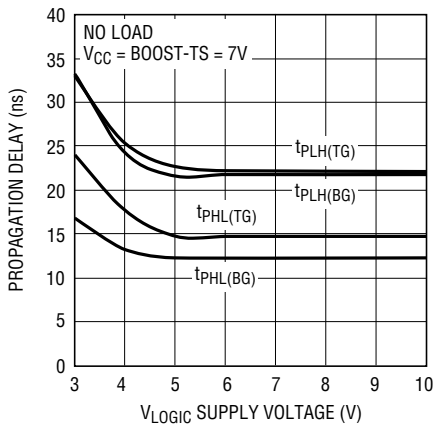

4442 G13

Propagation Delay vs V_{CC} Supply Voltage

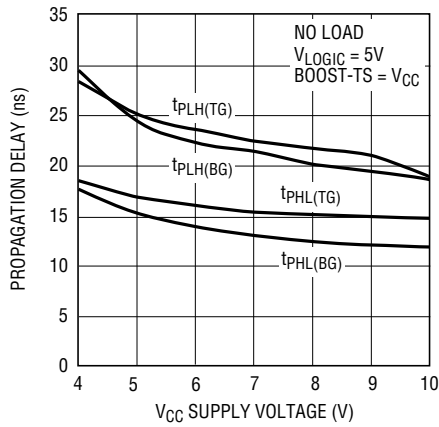

4442 G14

Propagation Delay vs Temperature

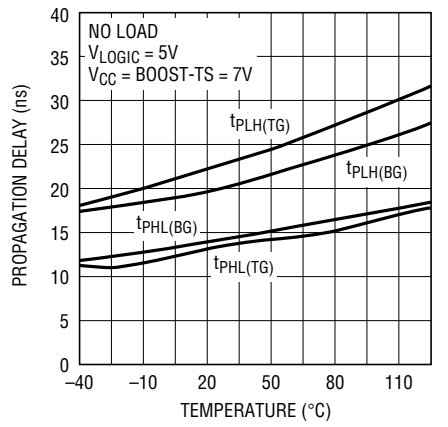

4442 G15

Output High Voltage vs V_{CC} Supply Voltage

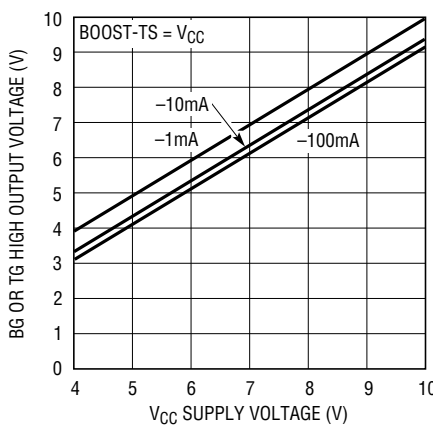

4442 G16

Rise and Fall Time vs V_{CC} Supply Voltage

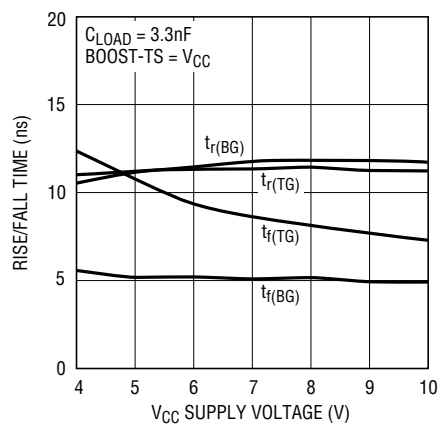

4442 G17

Rise and Fall Time vs Load Capacitance

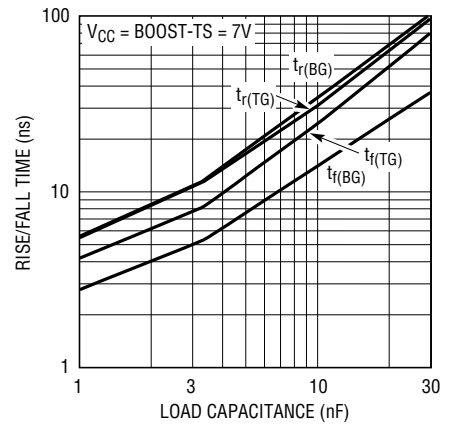

4442 G18

PIN FUNCTIONS

TG (Pin 1): High Side Gate Driver Output (Top Gate). This pin swings between TS and BOOST.

TS (Pin 2): High Side MOSFET Source Connection (Top Source).

BG (Pin 3): Low Side Gate Driver Output (Bottom Gate). This pin swings between V_{CC} and GND.

GND (Pin 4, Exposed Pad Pin 9): Chip Ground. The exposed pad must be soldered to the PCB ground for electrical contact and for rated thermal performance.

IN (Pin 5): Input Signal. Input referenced to an internal supply powered by V_{LOGIC} (Pin 6) and referenced to GND (Pin 4). If this pin is floating, an internal resistive divider triggers a shutdown mode in which both BG (Pin 3) and TG (Pin 1) are pulled low. Trace capacitance on this pin should be minimized to keep the shutdown time low.

V_{LOGIC} (Pin 6): Logic Supply. This pin powers the input buffer and logic. Connect this pin to the power supply of the controller that is driving IN (Pin 5) to match input thresholds or to V_{CC} (Pin 7) to simplify PCB routing.

V_{CC} (Pin 7): Output Driver Supply. This pin powers the low side gate driver output directly and the high side gate driver output through an external diode connected between this pin and BOOST (Pin 8). A low ESR ceramic bypass capacitor should be tied between this pin and GND (Pin 4).

BOOST (Pin 8): High Side Bootstrapped Supply. An external capacitor should be tied between this pin and TS (Pin 2). Normally, a bootstrap diode is connected between V_{CC} (Pin 7) and this pin. Voltage swing at this pin is from $V_{CC} - V_D$ to $V_{IN} + V_{CC} - V_D$, where V_D is the forward voltage drop of the bootstrap diode.

BLOCK DIAGRAM

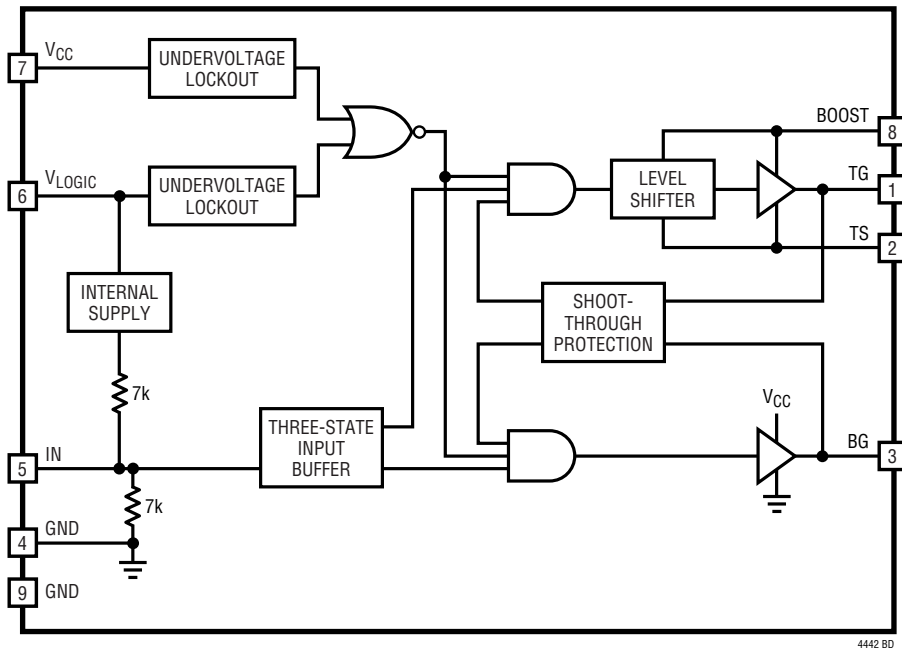

TIMING DIAGRAM

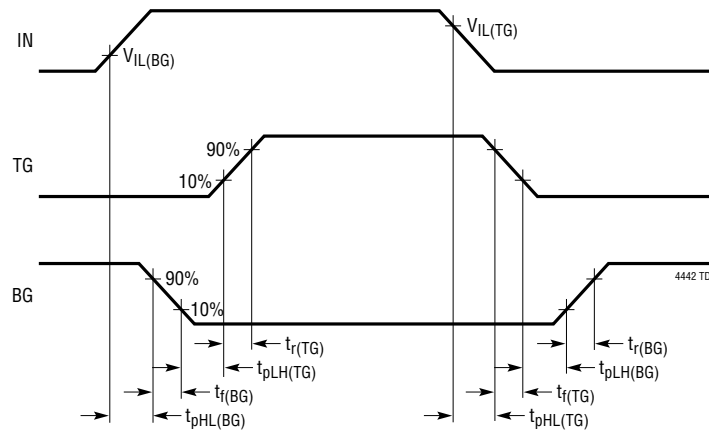

OPERATION

Overview

The LTC4442 receives a ground-referenced, low voltage digital input signal to drive two N-channel power MOSFETs in a synchronous buck power supply configuration. The gate of the low side MOSFET is driven either to V_{CC} or GND, depending on the state of the input. Similarly, the gate of the high side MOSFET is driven to either BOOST or TS by a supply bootstrapped off of the switch node (TS).

Input Stage

The LTC4442 employs a unique three-state input stage with transition thresholds that are proportional to the V_{LOGIC} supply. The V_{LOGIC} supply can be tied to the controller IC's power supply so that the input thresholds will match those of the controller's output signal. Alternatively, V_{LOGIC} can be tied to V_{CC} to simplify routing. An internal voltage regulator in the LTC4442 limits the input threshold values for V_{LOGIC} supply voltages greater than 5V.

The relationship between the transition thresholds and the three input states of the LTC4442 is illustrated in Figure 1. When the voltage on IN is greater than the threshold $V_{IH(TG)}$, TG is pulled up to BOOST, turning the high side MOSFET on. This MOSFET will stay on until IN falls below $V_{IL(TG)}$. Similarly, when IN is less than $V_{IH(BG)}$, BG is pulled up to V_{CC} , turning the low side (synchronous) MOSFET on. BG will stay high until IN increases above the threshold $V_{IL(BG)}$.

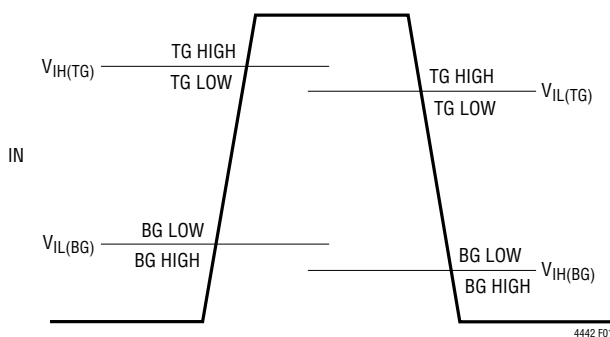

Figure 1. Three-State Input Operation

The thresholds are positioned to allow for a region in which both BG and TG are low. An internal resistive divider will pull IN into this region if the signal driving the IN pin goes into a high impedance state.

One application of this three-state input is to keep both of the power MOSFETs off while an undervoltage condition exists on the controller IC power supply. This can be accomplished by driving the IN pin with a logic buffer that has an enable pin. With the enable pin of the buffer tied to the power good pin of the controller IC, the logic buffer output will remain in a high impedance state until the controller confirms that its supply is not in an undervoltage state. The three-state input of the LTC4442 will therefore pull IN into the region where TG and BG are low until the controller has enough voltage to operate predictably.

The hysteresis between the corresponding V_{IH} and V_{IL} voltage levels eliminates false triggering due to noise during switch transitions; however, care should be taken to keep noise from coupling into the IN pin, particularly in high frequency, high voltage applications.

Undervoltage Lockout

The LTC4442 contains undervoltage lockout detectors that monitor both the V_{CC} and V_{LOGIC} supplies. When V_{CC} falls below 3.04V or V_{LOGIC} falls below 2.65V, the output pins BG and TG are pulled to GND and TS, respectively. This turns off both of the external MOSFETs. When V_{CC} and V_{LOGIC} have adequate supply voltage for the LTC4442 to operate reliably, normal operation will resume.

Adaptive Shoot-Through Protection

Internal adaptive shoot-through protection circuitry monitors the voltages on the external MOSFETs to ensure that they do not conduct simultaneously. The LTC4442 does not allow the bottom MOSFET to turn on until the gate-source voltage on the top MOSFET is sufficiently low, and vice-versa. This feature improves efficiency by

OPERATION

eliminating cross-conduction current from flowing from the V_{IN} supply through the MOSFETs to ground during a switch transition.

Output Stage

A simplified version of the LTC4442's output stage is shown in Figure 2. The pull-up device on both the BG and TG outputs is an NPN bipolar junction transistor (Q1 and Q2). The BG and TG outputs are pulled up to within an NPN V_{BE} ($\sim 0.7V$) of their positive rails (V_{CC} and BOOST, respectively). Both BG and TG have N-channel MOSFET pull-down devices (N1 and N2) which pull BG and TG down to their negative rails, GND and TS. An additional NPN bipolar junction transistor (Q3) is present on BG to increase its pull-down drive current capacity. The large voltage swing of the BG and TG output pins is important in driving external power MOSFETs, whose $R_{DS(ON)}$ is inversely proportional to its gate overdrive voltage ($V_{GS} - V_{TH}$).

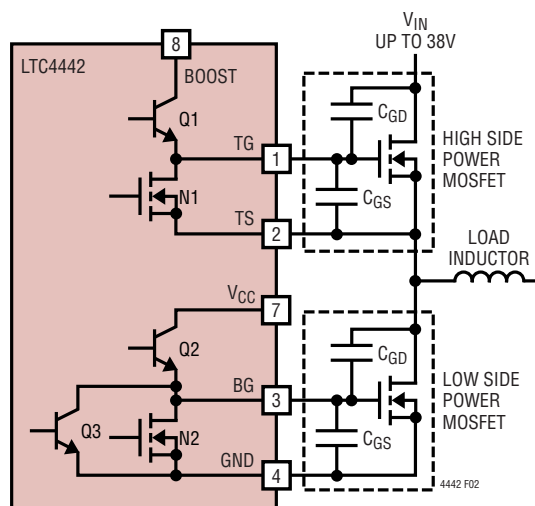

Figure 2. Capacitance Seen by BG and TG During Switching

Rise/Fall Time

Since the power MOSFET generally accounts for the majority of power loss in a converter, it is important to quickly turn it on and off, thereby minimizing the transition time and power loss. The LTC4442's peak pull-up current of 2.4A for both BG and TG (Q1 and Q2) produces a rapid turn-on transition for the MOSFETs. This high current is capable of driving a 3nF load with a 12ns rise time.

It is also important to turn the power MOSFETs off quickly to minimize power loss due to transition time; however, an additional benefit of a strong pull-down on the driver outputs is the prevention of cross-conduction current. For example, when BG turns the low-side power MOSFET off and TG turns the high-side power MOSFET on, the voltage on the TS pin will rise to V_{IN} very rapidly. This high frequency positive voltage transient will couple through the C_{GD} capacitance of the low side power MOSFET to the BG pin. If the BG pin is not held down sufficiently, the voltage on the BG pin will rise above the threshold voltage of the low side power MOSFET, momentarily turning it back on. As a result, both the high side and low side MOSFETs will be conducting, which will cause significant cross-conduction current to flow through the MOSFETs from V_{IN} to ground, thereby introducing substantial power loss. A similar effect occurs on TG due to the C_{GS} and C_{GD} capacitances of the high side MOSFET.

The LTC4442's powerful parallel combination of the N-channel MOSFET (N2) and NPN (Q3) on the BG pull-down generates a phenomenal 5ns fall time on BG while driving a 3nF load. Similarly, the 1Ω pull-down MOSFET (N1) on TG results in a rapid 8ns fall time with a 3nF load. These powerful pull-down devices minimize the power loss associated with MOSFET turn-off time and cross-conduction current.

APPLICATIONS INFORMATION

Power Dissipation

To ensure proper operation and long-term reliability, the LTC4442 must not operate beyond its maximum temperature rating. Package junction temperature can be calculated by:

$$T_J = T_A + (P_D)(\theta_{JA})$$

where:

T_J = Junction temperature

T_A = Ambient temperature

P_D = Power dissipation

θ_{JA} = Junction-to-ambient thermal resistance

Power dissipation consists of standby, switching and capacitive load power losses:

$$P_D = P_{DC} + P_{AC} + P_{QG}$$

where:

P_{DC} = Quiescent power loss

P_{AC} = Internal switching loss at input frequency f_{IN}

P_{QG} = Loss due turning on and off the external MOSFET with gate charge Q_G at frequency f_{IN}

The LTC4442 consumes very little quiescent current. The DC power loss at $V_{LOGIC} = 5V$ and $V_{CC} = V_{BOOST} - TS = 7V$ is only $(730\mu A)(5V) + (625\mu A)(7V) = 8mW$.

At a particular switching frequency, the internal power loss increases due to both AC currents required to charge and discharge internal nodal capacitances and cross-conduction currents in the internal logic gates. The sum of the quiescent current and internal switching current with no load are shown in the Typical Performance Characteristics plot of Switching Supply Current vs Input Frequency.

The gate charge losses are primarily due to the large AC currents required to charge and discharge the capacitance of the external MOSFETs during switching. For identical pure capacitive loads C_{LOAD} on TG and BG at switching frequency f_{IN} , the load losses would be:

$$P_{CLOAD} = (C_{LOAD})(f_{IN})[(V_{BOOST} - TS)^2 + (V_{CC})^2]$$

In a typical synchronous buck configuration, $V_{BOOST} - TS$ is equal to $V_{CC} - V_D$, where V_D is the forward voltage drop across the diode between V_{CC} and BOOST. If this drop is small relative to V_{CC} , the load losses can be approximated as:

$$P_{CLOAD} \approx 2(C_{LOAD})(f_{IN})(V_{CC})^2$$

Unlike a pure capacitive load, a power MOSFET's gate capacitance seen by the driver output varies with its V_{GS} voltage level during switching. A MOSFET's capacitive load power dissipation can be calculated using its gate charge, Q_G . The Q_G value corresponding to the MOSFET's V_{GS} value (V_{CC} in this case) can be readily obtained from the manufacturer's Q_G vs V_{GS} curves. For identical MOSFETs on TG and BG:

$$P_{QG} \approx 2(V_{CC})(Q_G)(f_{IN})$$

To avoid damaging junction temperatures due to power dissipation, the LTC4442 includes a temperature monitor that will pull BG and TG low if the junction temperature exceeds 160°C. Normal operation will resume when the junction temperature cools to less than 135°C.

Bypassing and Grounding

The LTC4442 requires proper bypassing on the V_{LOGIC} , V_{CC} and $V_{BOOST} - TS$ supplies due to its high speed switching (nanoseconds) and large AC currents (Amperes). Careless component placement and PCB trace routing may cause excessive ringing and undershoot/overshoot.

APPLICATIONS INFORMATION

To obtain the optimum performance from the LTC4442:

- A. Mount the bypass capacitors as close as possible between the V_{LOGIC} and GND pins, the V_{CC} and GND pins, and the BOOST and TS pins. The leads should be shortened as much as possible to reduce lead inductance.
- B. Use a low inductance, low impedance ground plane to reduce any ground drop and stray capacitance. Remember that the LTC4442 switches greater than 5A peak currents and any significant ground drop will degrade signal integrity.
- C. Plan the power/ground routing carefully. Know where the large load switching current is coming from and going to. Maintain separate ground return paths for the input pin and the output power stage.
- D. Keep the copper traces between the driver output pins and the load short and wide.
- E. Be sure to solder the Exposed Pad on the back side of the LTC4442 packages to the board. Correctly soldered to a 2500mm² double-sided 1oz copper board, the LTC4442 has a thermal resistance of approximately 40°C/W. Failure to make good thermal contact between the exposed back side and the copper board will result in thermal resistances far greater.

PACKAGE DESCRIPTION

MS8E Package 8-Lead Plastic MSOP, Exposed Die Pad (Reference LTC DWG # 05-08-1662 Rev E)

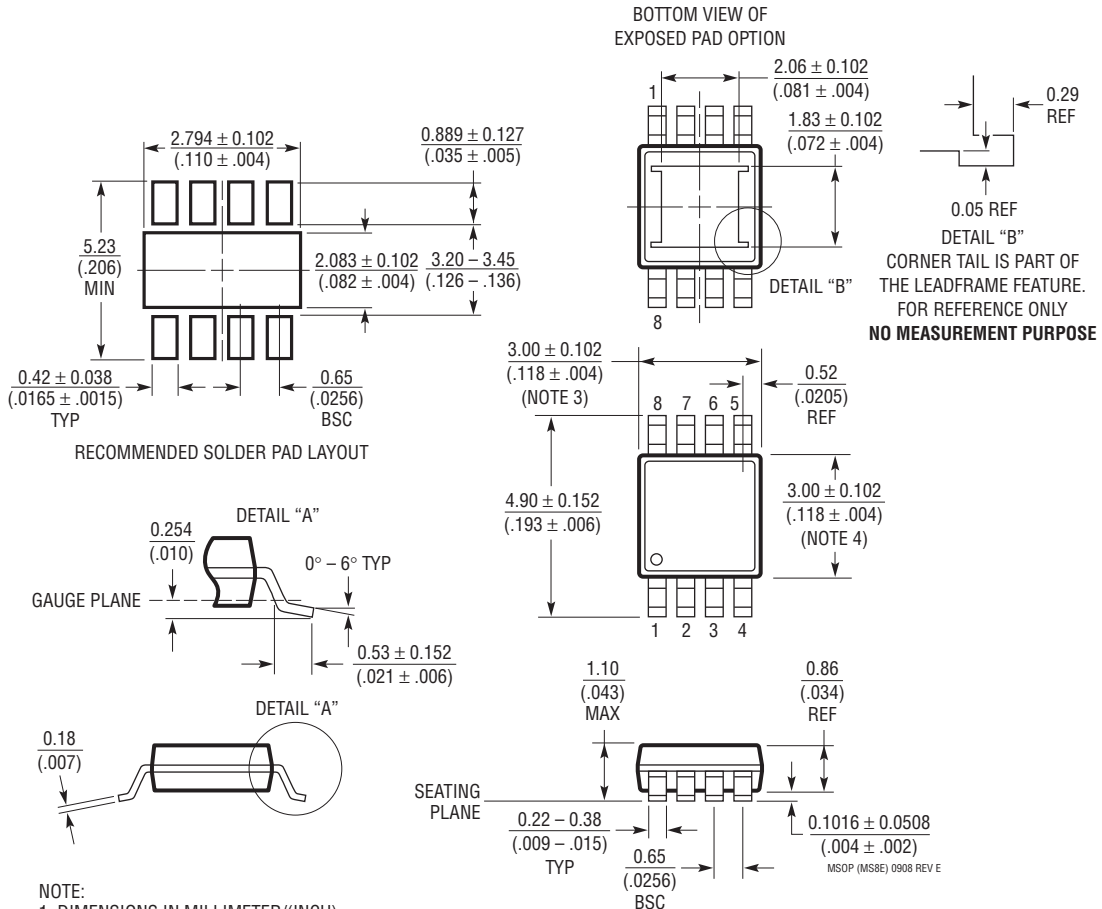

NOTE:

1. DIMENSIONS IN MILLIMETER/(INCH)
2. DRAWING NOT TO SCALE
3. DIMENSION DOES NOT INCLUDE MOLD FLASH, PROTRUSIONS OR GATE BURRS.
MOLD FLASH, PROTRUSIONS OR GATE BURRS SHALL NOT EXCEED 0.152mm (.006") PER SIDE
4. DIMENSION DOES NOT INCLUDE INTERLEAD FLASH OR PROTRUSIONS.
INTERLEAD FLASH OR PROTRUSIONS SHALL NOT EXCEED 0.152mm (.006") PER SIDE
5. LEAD COPLANARITY (BOTTOM OF LEADS AFTER FORMING) SHALL BE 0.102mm (.004") MAX

REVISION HISTORY (Revision history begins at Rev B)

REV	DATE	DESCRIPTION	PAGE NUMBER
B	4/10	Updated Pin Configuration	2
		Updated GND (Pin 4) in Pin Functions	6
		Updated Related Parts	14

LTC4442/LTC4442-1

TYPICAL APPLICATION

LTC7510/LTC4442-1 12V to 1.5V/30A Digital Step-Down DC/DC Converter with PMBus Serial Interface

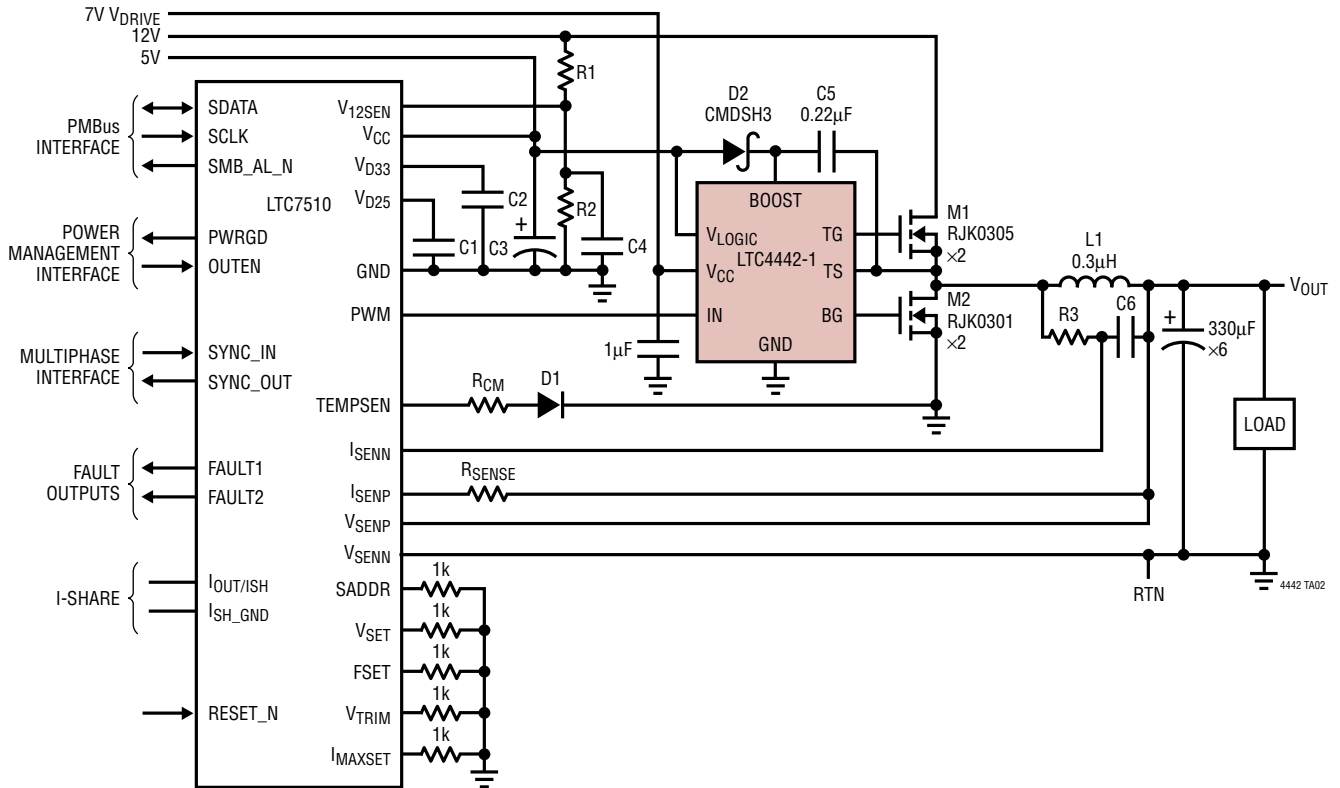

RELATED PARTS

PART NUMBER	DESCRIPTION	COMMENTS
LTC4449	High Speed Synchronous N-Channel MOSFET Driver	Up to 38V Supply Voltage, $4.5V \leq V_{CC} \leq 6.5V$, 3.2A Peak Pull-Up/ 4.5A Peak Pull-Down
LTC4444/ LTC4444-5	High Voltage Synchronous N-Channel MOSFET Driver with Shoot Through Protection	Up to 100V Supply Voltage, $4.5V/7.2V \leq V_{CC} \leq 13.5V$, 3A Peak Pull-Up/ 0.55Ω Peak Pull-Down
LTC4446	High Voltage Synchronous N-Channel MOSFET Driver without Shoot Through Protection	Up to 100V Supply Voltage, $7.2V \leq V_{CC} \leq 13.5V$, 3A Peak Pull-Up/ 0.55Ω Peak Pull-Down
LTC4440/ LTC4440-5	High Speed, High Voltage High Side Gate Driver	Up to 80V Supply Voltage, $8V \leq V_{CC} \leq 15V$, 2.4A Peak Pull-Up/ 1.5Ω Peak Pull-Down
LTC4441/ LTC4441-1	N-Channel MOSFET Gate Driver	Up to 25V Supply Voltage, $5V \leq V_{CC} \leq 25V$, 6A Peak Output Current
LTC1154	High Side Micropower MOSFET Driver	Up to 18V Supply Voltage, 85μA Quiescent Current, H-Grade Available

4442fb



Стандарт Электрон Связь

Мы молодая и активно развивающаяся компания в области поставок электронных компонентов. Мы поставляем электронные компоненты отечественного и импортного производства напрямую от производителей и с крупнейших складов мира.

Благодаря сотрудничеству с мировыми поставщиками мы осуществляем комплексные и плановые поставки широчайшего спектра электронных компонентов.

Собственная эффективная логистика и склад в обеспечивает надежную поставку продукции в точно указанные сроки по всей России.

Мы осуществляем техническую поддержку нашим клиентам и предпродажную проверку качества продукции. На все поставляемые продукты мы предоставляем гарантию .

Осуществляем поставки продукции под контролем ВП МО РФ на предприятия военно-промышленного комплекса России , а также работаем в рамках 275 ФЗ с открытием отдельных счетов в уполномоченном банке. Система менеджмента качества компании соответствует требованиям ГОСТ ISO 9001.

Минимальные сроки поставки, гибкие цены, неограниченный ассортимент и индивидуальный подход к клиентам являются основой для выстраивания долгосрочного и эффективного сотрудничества с предприятиями радиоэлектронной промышленности, предприятиями ВПК и научно-исследовательскими институтами России.

С нами вы становитесь еще успешнее!

Наши контакты:

Телефон: +7 812 627 14 35

Электронная почта: sales@st-electron.ru

Адрес: 198099, Санкт-Петербург,
Промышленная ул, дом № 19, литера Н,
помещение 100-Н Офис 331