

Amphenol
SINESYSTEMS

RT360™

Circular Connectors



INTERCONNECTING YOUR WORLD

We are Amphenol Sine Systems.

We are a global leader in providing you with interconnection options and solutions.

We fulfill the needs of Industrial, Factory Automation, Heavy Duty and Custom-design markets.

Amphenol Sine Systems, with its 42 year history, 325+ employees worldwide and 3 global facilities, draws on the extensive worldwide resources of Amphenol Corporation to find solutions for our customers. Our engineers design innovative combinations of industry standard connectors and application specific shielding components to create assembly systems that set the standards for performance, reliability, and cost effectiveness. Our engineering, materials, and manufacturing organizations meet the high standards imposed by ISO 9001 as well as many customer specific quality systems. Our performance has earned us ship to stock and world class performance awards from many major OEMs.



Amphenol Sine Systems is a division of **Amphenol Corporation** (www.amphenol.com), one of the largest interconnect solution suppliers in the world. Amphenol Corporation supplies a wide range of product solutions worldwide. Amphenol Corporation, and all its subsidiaries, design, manufacture and market electrical, electronic and fiber-optic connectors, interconnect systems and coaxial and specialty cable. Amphenol has a diversified presence in high growth markets including: Information Technology and Data Communications Equipment, Mobile Devices, Mobile Networks, Broadband Communication, Military and Commercial Aerospace, Industrial and Automotive.

Table of Contents

| | |
|---|------------|
| Description | 1 |
| Features & Benefits..... | 1 |
| Part Ordering Guide - RT/RTOW & RTHP Series Plugs and Receptacles | 2 |
| Part Ordering Guide - RT/RTOW Series Machined Contacts | 3 |
| Part Ordering Guide - RT/RTOW Series Stamped & Formed Contacts | 4 |
| Radsok® Technical Information | 5 |
| Part Ordering Guide - RTHP Series Machined Contacts..... | 6 |
| RTHP Series Typical Product Picture and Installation Dimension..... | 6 |
| Insert Configurations | 7 |
| Box and Wall Mounts | 8 |
| Straight Plugs | 8 |
| Jam Nut Receptacle | 9 |
| Cord Grips..... | 9 |
| Metal Cable Clamp Cord Grip | 10 |
| Wall Mounted Receptacle for Flat Hole Tail | 11 |
| Straight Cable Plug with Cord Grip Solution..... | 11 |
| Straight Cable Plug with End Cap | 12 |
| Straight Cable Plug with 90° Cord Grip Solution | 12 |
| Accessories & Tooling - | |
| Dust Caps..... | 13 |
| Sealing Plugs..... | 13 |
| Universal Hand Crimp Tool..... | 13 |
| Stamp Contact Tool | 13 |
| Contact Extraction Tool | 13 |
| Crimp Die | 14 |
| Pneumatic Crimp Tool..... | 14 |
| Gaskets..... | 14 |
| Worldwide Company Locations | Back Cover |

© 2011 Amphenol Sine Systems Corporation. Every effort has been made to ensure that the information contained in this catalog is accurate at the time of publication. Specifications or information stated in this publication are subject to change without notice. Revised 10/2011

Description

RT360™ industrial circular connectors are multiway connector available in 6 shell sizes and 22 insert arrangements with a variety of wire gauge options. RT360 industrial circular connectors were designed to be intermateable with other industrial connector families.

| TECHNICAL DATA | RT Series | RTOW Series | RTHP Series |
|---------------------------------|-------------------------------|-------------|-----------------|
| Temperature Range | -40°C to +105°C or 125°C | | -40°C to +125°C |
| Protection | IP67, IP68 | | IP67, IP68 |
| DATA - ACCORDING TO UL 840 | RT Series | RTOW Series | RTHP Series |
| Degree of Protection | 3 | | |
| Over Voltage Category | III | | |
| MATERIALS | RT Series | RTOW Series | RTHP Series |
| Housing Body | Zinc alloy, Die-cast | | |
| Coupling Nut | Aluminum alloy, Nickel-plated | | |
| Insulation Inserts | Thermosplastic, UL 94 / V0 | | |
| Contacts | Brass, Gold-plated | | |
| Seals | Silicone | | |
| ELECTRICAL DATA | RT Series | RTOW Series | RTHP Series |
| Max. Current (Max. Wire Gauge) | Max. 40A | Max. 7.5A | Max. 455A |
| Maximum Voltage | 300V AC/DC | 150V AC/DC | 630V AC/DC |
| Contact Resistance | < 6 mΩ | < 15 mΩ | < 1 mΩ |
| Test Voltage (Between Contacts) | 2000V | 1500V | 6000V |
| Minimum Mating Cycles | > 200 | | |
| Salt Spray Resistance | 48,96h (customized 200,500h) | | |
| Shielded | Cord Grip | | |



RT Series



RTOW Series



RTHP Series

RT Series

- 6 shell sizes and 11 insert configurations
- Offer standard insert arrangements from 4-28 contacts, mixed Power and Signal arrangements
- Operating voltage of 300V
- Current rating: 13A(signal contacts)
- Alternate keying positions available
- Plastic inserts with flammability rating of UL94-V0
- RoHS compliant

RTOW Series

- 6 shell sizes and 5 insert configurations
- Mating with MIL-C-24682 series connectors
- High density arrangements from 6-32 contacts
- Operating voltage of 150V
- Current rating of 7.5A with machined contacts and 5A with stamped and formed contacts
- Alternate keying positions available
- Plastic inserts with flammability rating of UL94-V0
- RoHS compliant

RTHP Series

- 4 shell sizes and 5 insert configurations
- Single pole High Power arrangements
- 3.6mm-10mm contact sizes
- Operating voltage of 630V
- Current rating: 56A-455A (see page 5)
- Plastic inserts with flammability rating of UL94-V0
- RoHS compliant

Part Ordering Guide - RT/RTOW & RTHP Series Plugs & Receptacles

| SERIES | SHELL TYPE | SHELL SIZE | INSERT ARRANGEMENT | TYPE OF CONTACTS | INSERT POLARIZATION | APPLICATION | PLATING | DESIGN VARIATION |
|--------|------------|------------|--------------------|------------------|---------------------|-------------|---------|------------------|
| * | * | * | * | * | * | * | * | * |

RT/RTOW SERIES

SERIES

- RT
- RTOW

SHELL TYPE

- 0: Wall mount recep.
- 6: Cable plug
- 7: Jam nut recep. / rear panel mount

SHELL SIZE

- 10, 12, 14, 16, 18, 20

INSERT ARRANGEMENT

- See Page 7

TYPE OF CONTACTS

- P: Pin contacts
- S: Socket contacts

INSERT POLARIZATION (See Detail below)

- N: Standard version
- W, X, Y, Z: Custom orientation

APPLICATION

- Blank: Standard version (no o-ring)
- H: Standard version, water protection IP67

PLATING

- Blank: Standard is nickel plating (48hr salt spray)
- 1: Black anodized, jam nut (96hr salt spray)
- 2: Black anodized coupling ring (96hr salt spray)

DESIGN VARIATION

- EC: Standard version for 18-14AWG with end cap
- MM: Reduced seal for 24-20AWG with end cap

RTHP SERIES

SERIES

- RTHP

SHELL TYPE

- 0: Wall mount recep.
- 6: Cable plug
- 7: Jam nut recep. / rear panel mount

SHELL SIZE

- 12, 14, 16, 20

INSERT ARRANGEMENT

- See Page 7

TYPE OF CONTACTS

- P: Pin contacts
- S: Socket contacts

INSERT POLARIZATION

- N: Standard version

APPLICATION

- Blank: Standard version (no o-ring)
- H: Standard version, water protection IP67/69

PLATING

- Blank: Standard is nickel plating (48hr salt spray)
- 1: Black anodized, jam nut (96hr salt spray)
- 2: Black anodized coupling ring (96hr salt spray)

DESIGN VARIATION

- Blank: Standard version
- C: Crimp contact
- EC: Crimp contact with end cap
- FG: Crimp contact with flex grip
- H: Flat hole
- M: Screw tail
- S: Crimp contact with cord grip

Detail

Mating Face View of Pin Inserts

The five positions (W, X, Y, Z and Normal) differ in degree of rotation for various sizes and arrangements.

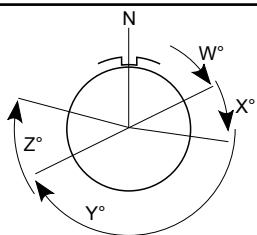

Note: Higher salt spray resistance (200/500h) upon request.

Part Ordering Guide - RT/RTOW Series Machined Contacts

| SERIES | WIRE SIZE | CONTACT SIZE | CONTACT PACKAGING | DESIGN VARIATION | GROUNDING CONTACT | PLATING |
|--------|-----------|--------------|-------------------|------------------|-------------------|---------|
| * | * | * | * | * | * | * |

SERIES

- **MP:** Male; **MS:** Female

WIRE SIZE

- **14:** 14AWG (2.5mm); **16:** 18-16AWG (.75-1.5mm); **20:** 22-20AWG (.34-.50mm);
- **24:** 26-24AWG (.14-.25mm); **28:** 30-28AWG (.05-.08mm); **8:** 10-8AWG (6-10mm)

CONTACT SIZE

- **M:** Size 16; **W:** Size 20; **A:** Size 8 Power Contact

CONTACT PACKAGING

- **BP:** Bulk Pack only

DESIGN VARIATION

- **23:** Crimp Barrel; **12E0xx:** PCB tail, for RT00(wall mouting receptacle) **xx** is outer length of PCB tail; **12E7xx:** PCB tail, for RT07(Jam Nut Receptacle) **xx** is outer length of PCB tail; **RS8:** Radsok 3.6mm, crimp barrel

GROUNDING CONTACT

- **GE1:** For Male GND contacts (1 mm longer) add **GE1** to the part number (ex: MP16M23GE1G15); **GE1:** For Female GND contacts (1.5 mm longer) add **GE1** to the p/n (ex: MS16M23GE1G15); **GE7:** For Female Last Mate contacts (0.6 mm shorter) add **GE7** to the part number (ex: MS16M23GE7G15)

PLATING

- **T:** Tin; **F:** Gold Flash; **G:** Gold Plate [Thickness: 10u"]; **G30:** Gold Plate [Thickness: 30u"]; **N:** Nickel; **S:** Plating Silver (5um)



| Contact Size | Wire Range | | Plating | Male P/N | Female P/N |
|--------------|------------|---------|------------|------------|------------|
| | AWG | mm | | | |
| 8 | 10-8 | 6-10 | Silver | MP10A23S | MS10A23S |
| 16 | 14 | 2.5 | Silver | MP14M23S | MS14M23S |
| | | | Gold Flash | MP14M23F | MS14M23F |
| | | | Gold 30u" | MP14M23G30 | MS14M23G30 |
| 16 | 18-16 | .75-1.5 | Silver | MP16M23S | MS16M23S |
| | | | Gold Flash | MP16M23F | MS16M23F |
| | | | Gold 30u" | MP16M23G30 | MS16M23G30 |
| 16 | 22-20 | .34-.50 | Silver | MP20M23S | MS20M23S |
| | | | Gold Flash | MP20M23F | MS20M23F |
| | | | Gold 30u" | MP20M23G30 | MS20M23G30 |
| 16 | 26-24 | .14-.25 | Silver | MP24M23S | MS24M23S |
| | | | Gold Flash | MP24M23F | MS24M23F |
| | | | Gold 30u" | MP24M23G30 | MS24M23G30 |
| 20 | 22-20 | .34-.50 | Silver | MP20W23S | MS20W23S |
| | | | Gold Flash | MP20W23F | MS20W23F |
| | | | Gold 30u" | MP20W23G30 | MS20W23G30 |
| 20 | 30-28 | .05-.08 | Silver | MP28W23S | MS28W23S |
| | | | Gold Flash | MP28W23F | MS28W23F |
| | | | Gold 30u" | MP28W23G30 | MS28W23G30 |



RockSolid™
Connections
Hyperbolic Contact
Option

- Longer contact life
- Lower contact resistance
- Immunity to shock and vibration
- Low insertion and extraction forces
- Contact area extends 360° around pins



Part Ordering Guide - RT/RTOW Series Stamped & Formed Contacts

| SERIES | WIRE SIZE AWG CRIMP | CONTACT SIZE | CONTACT PACKAGING | DESIGN VARIATION | PLATING |
|--------|------------------------|--------------|-------------------|------------------|---------|
| * | * | * | * | * | * |

SERIES

- **SP:** Male; **SS:** Female

WIRE SIZE

- **2.5mm:** 2.5mm; **16:** 18-16AWG (.75-1.5mm); **20:** 22-20AWG (.34-.50mm); **24:** 26-24AWG (.14-.25mm); **28:** 30-28AWG (.05-.08mm)

CONTACT SIZE

- **M:** Size 16; **W:** Size 20; **A:** 2.5mm contact

CONTACT PACKAGING

- **Blank:** 3,000 pc reel; **L:** Loose Piece

DESIGN VARIATION

- **1:** Crimp type

PLATING

- **T:** Tin; **F:** Gold Flash; **G:** Gold Plate [Thickness: 10u"]; **G30:** Gold Plate [Thickness: 30u"]; **N:** Nickel; **S:** Silver



| Contact Size | Wire Range | | Plating | Male P/N | Female P/N |
|--------------|------------|---------|------------|-----------|------------|
| | AWG | mm | | | |
| 2.5mm | NA | 2.5 | Tin | SP12A1T | SS12A1T |
| 16 | 14 | 2.5 | Gold Flash | SP14M1F | SS14M1F |
| | | | Gold 10u" | SP14M1G10 | SS14M1G10 |
| | | | Gold 30u" | SP14M1G30 | SS14M1G30 |
| 16 | 18-16 | .75-1.5 | Gold Flash | SP16M1F | SS16M1F |
| | | | Gold 10u" | SP16M1G10 | SS16M1G10 |
| | | | Gold 30u" | SP16M1G30 | SS16M1G30 |
| 16 | 22-20 | .34-.50 | Gold Flash | SP20M1F | SS20M1F |
| | | | Gold 10u" | SP20M1G10 | SS20M1G10 |
| | | | Gold 30u" | SP20M1G30 | SS20M1G30 |
| 16 | 26-24 | .14-.25 | Gold Flash | SP24M1F | SS24M1F |
| | | | Gold 10u" | SP24M1G10 | SS24M1G10 |
| | | | Gold 30u" | SP24M1G30 | SS24M1G30 |
| 20 | 22-20 | .34-.50 | Gold Flash | SP20W1F | SS20W1F |
| | | | Gold 10u" | SP20W1G10 | SS20W1G10 |
| | | | Gold 30u" | SP20W1G30 | SS20W1G30 |
| 20 | 26-24 | .14-.25 | Gold Flash | SP24W1F | SS24W1F |
| | | | Gold 10u" | SP24W1G10 | SS24W1G10 |
| | | | Gold 30u" | SP24W1G30 | SS24W1G30 |

RADSOK® Technical Information

High Reliability

Unique RADSOK® design and construction technology create an electrical contact interface that exceeds typical interconnect requirements. Applications in Aerospace, Medical, Industrial, Automotive, Mining, Offshore and other harsh environments depend on high reliability of the Amphenol RADSOK® technology.

Low Contact Engagement/Separation Forces

The hyperbolic lamella socket contact construction distributes normal forces over a high percentage of the mating surface. This creates a smooth, even engagement effort. This force distribution also contributes to excellent performance in vibration applications with resistance to typical fretting corrosion.

Low Contact Resistance

The large interface between the socket lamella and pin surface result in very low contact resistance, enabling the RADSOK® contacts' high current ratings compared to traditional power contact designs.

High Mating Cycle Durability

RADSOK® contacts with typical silver plating finishes have demonstrated survival of 20,000 mating cycles. Specialized plating and contact lubricants can extend cycle life to 200,000 mating or higher. Even with continuous exposure to harsh environmental abuse (salt, sand and high humidity), RADSOK® contacts have been tested to maintain low contact resistance beyond 10,000 mating cycles.



| RTHP RADSOK® | 3.6mm | 6mm | 8mm | 10mm |
|---------------------------|---|--|---|---|
| Current (DIN EN 60512) | 115A (23°C) 107A (40°C) 86A (80°C) 56A (120°C) | 155A (23°C) 148A (40°C) 116A (80°C) 77A (120°C) | 240A (23°C) 235A (40°C) 185A (80°C) 120A (120°C) | 455A (23°C) 425A (40°C) 342A (80°C) 222A (120°C) |
| Contact Resistance | = 0.15mΩ | = 0.11mΩ | = 0.08mΩ | = 0.03mΩ |
| Mating Force | = 6N | = 12N | = 18N | = 24.8N |
| m | 6.1g | 17.5g | 32g | 55.2g |
| l | 13.2mm | 21.9mm | 25.7mm | 25.7mm |
| di | 3.6mm | 6mm | 8mm | 10mm |
| da | 6mm | 9.5mm | 13.5mm | 15.7mm |
| Plating | Grid: Silver Sleeve: Silver | Grid: Silver Sleeve: Silver | Grid: Silver Sleeve: Silver | Grid: Silver Sleeve: Silver |

Note: The given electrical values correspond to a single contact. With the addition of a housing, an increased number of poles or other modifications, the values must be adjusted downwards accordingly.

Part Ordering Guide - RTHP Series Machined Contacts

| SERIES | WIRE SIZE | CONTACT SIZE | CONTACT PACKAGING | DESIGN VARIATION | PLATING |
|--------|-----------|--------------|-------------------|------------------|---------|
| * | * | * | * | * | * |

SERIES

- **HP:** Male; **HS:** Female

WIRE SIZE

- **10:** 8-10mm²; **16:** 13-16mm²; **25:** 20-25mm²; **35:** 30-35mm²; **50:** 40-50mm²; **75:** 70-75mm²

CONTACT SIZE

- **A:** 3.6mm; **B:** 6mm; **C:** 8mm; **D:** 10mm

CONTACT PACKAGING

- **BP:** Bulk Pack Only

DESIGN VARIATION

- **C:** Crimp Barrel; **P:** PCB Tail; **S:** Screw Tail; **W:** Soldier Tail; **H:** Flat Hole Tail

PLATING

- **T:** Tin; **F:** Gold Flash; **G:** Gold Plate [Thickness: 10u"]; **G30:** Gold Plate [Thickness: 30u"]; **N:** Nickel; **S:** Plating Silver (5um)



| Contact Size | Wire Range | Plating | Male P/N | Female P/N | Type |
|--------------|------------|---------|----------|------------|---------------|
| 3.6mm | 8-10mm | Silver | HP10ACS | HS10ACS | Crimp |
| | | | HP10ASS | HS10ASS | Screwtail |
| | | | HP10AHS | HS10AHS | Flathole Tail |
| 6mm | 20-25mm | Silver | HP25BCS | HS25BCS | Crimp |
| | | | HP25BSS | HS25BSS | Screwtail |
| | | | HP25BHS | HS25BHS | Flathole Tail |
| 8mm | 30-35mm | Silver | HP35CCS | HS35CCS | Crimp |
| | | | HP35CSS | HS35CSS | Screwtail |
| | | | HP35CHS | HS35CHS | Flathole Tail |
| 10mm | 40-50mm | Silver | HP50DCS | HS50DCS | Crimp |
| | | | HP50DSS | HS50DSS | Screwtail |
| | | | HP50DHS | HS50DHS | Flathole Tail |

Consult Factory for additional Touch Proof options.

Typical Product Picture and Installation Dimension - RTHP Series





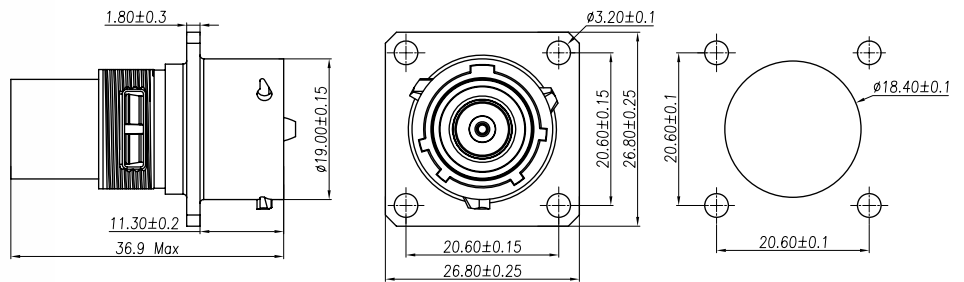

To be used within HV and EV when enduring large current and high voltage

Wall Mounting Receptacle for Crimp Barrel

Part Number: RTHP0121PNH-16C

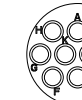
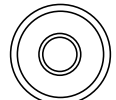
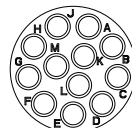
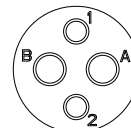
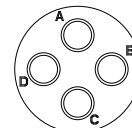
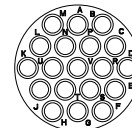

Insert Configuration

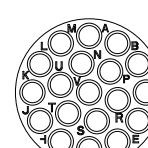
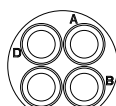
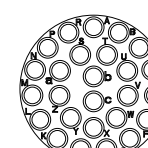
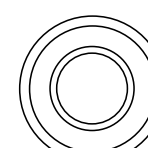
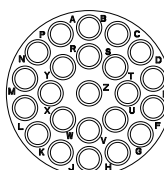
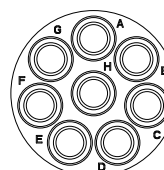
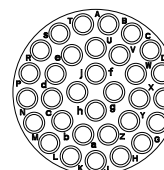
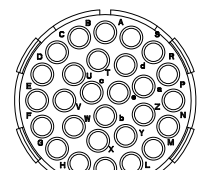
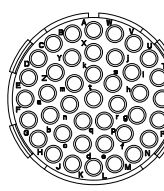
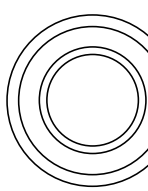
| RT | | | RTOW | RTHP Radsok® | |
|--|--|--|---|--|--|
| #16 Contacts (1.6mm) 13A/250V | VDE Versions Mixed Power/Signal | Contacts (2.5mm) | #20 Contacts (1.0mm) 5A/150V (1) 7.5A/150V (2) | Single Pin Power | |
| Note: Specific to RTOW, (1) refers to Stamped and Formed contacts; (2) refers to Machined contacts. | | | | | |
| Shell 10 |  10-4 |  10-2 2x#16(13A)/2X#20(5A) 350V AC/DC | N/A |  10-6 | N/A |
| Shell 12 |  12-3 | N/A | N/A |  12-10 |  12-1 1x3.6mm (86A) 600V AC/DC |
| Shell 14 |  14-12 |  14-2 2x2.5(23A)/2x#16(13A) 350V AC/DC |  14-4 (23A) 350V AC/DC |  14-19 |  14-1 1x6mm (116A) 600V AC/DC |
| Shell 16 |  16-19 |  16-4 4x#8(46A) 400 AC/DC | N/A |  16-26 |  16-1 1x8mm (185A) 600V AC/DC |
| Shell 18 |  18-23 | N/A |  18-8 (23A) 375V AC/DC |  18-32 | N/A |
| Shell 20 |  20-28 | N/A | N/A |  20-41 |  20-1 1x10mm (342A) 600V AC/DC |

All dimensions are in mm. Face Views are not actual size and are only meant as a representation.

Box and Wall Mounts

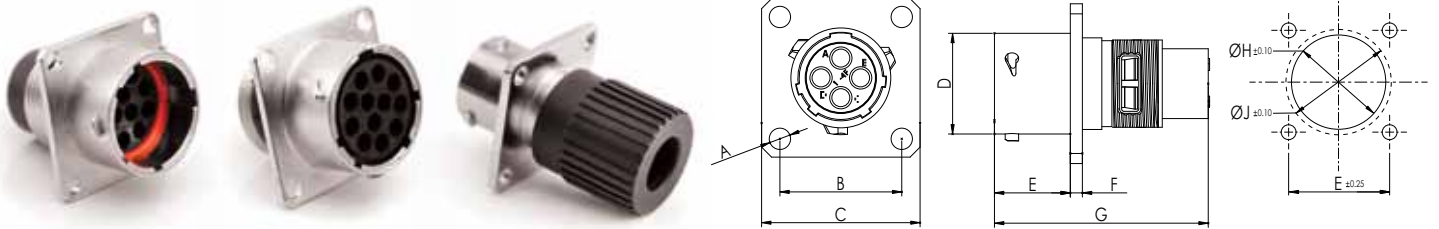

| | A | B | C | D | E | F | G | H | J |
|----------|------|-------|-------|-------|-------|------|-------|-------|-------|
| Shell 10 | 3.20 | 18.30 | 23.80 | 15.00 | 11.30 | 1.80 | 31.85 | 17.30 | 14.20 |
| Shell 12 | 3.20 | 20.62 | 26.20 | 19.00 | 11.30 | 1.80 | 31.85 | 21.80 | 18.40 |
| Shell 14 | 3.20 | 23.00 | 28.60 | 22.20 | 11.30 | 1.80 | 31.85 | 25.00 | 21.50 |
| Shell 16 | 3.20 | 24.60 | 31.00 | 25.30 | 11.30 | 1.80 | 31.85 | 28.10 | 24.60 |
| Shell 18 | 3.20 | 26.95 | 33.30 | 28.55 | 11.30 | 1.80 | 31.85 | 31.30 | 27.80 |
| Shell 20 | 3.20 | 29.50 | 36.50 | 31.70 | 14.55 | 2.40 | 33.65 | 34.50 | 30.90 |

Straight Plugs

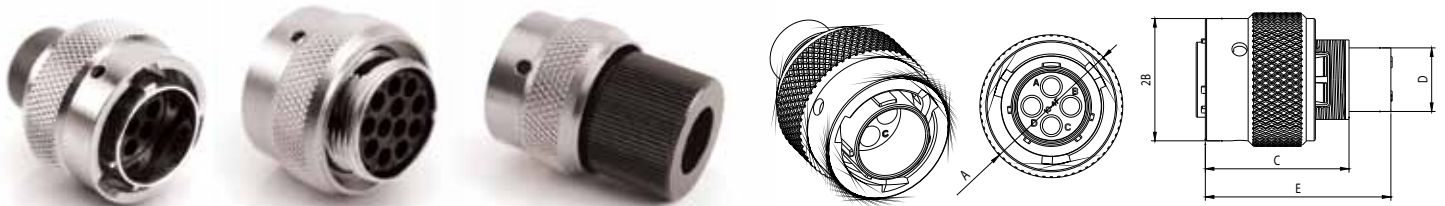

| | A | B | C | D | E |
|----------|-------|-------|-------|-------|-------|
| Shell 10 | 21.80 | 20.00 | 23.50 | 10.40 | 30.35 |
| Shell 12 | 26.10 | 23.60 | 23.50 | - | 30.35 |
| Shell 14 | 29.30 | 26.80 | 25.32 | 16.65 | 32.17 |
| Shell 16 | 32.45 | 30.00 | 23.50 | 19.50 | 30.35 |
| Shell 18 | 35.25 | 33.30 | 23.50 | 21.90 | 30.45 |
| Shell 20 | 38.55 | 36.55 | 25.80 | 25.20 | 30.65 |

Jam Nut Receptacle

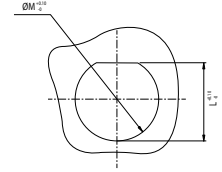
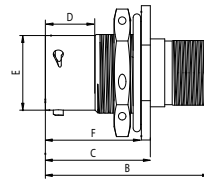
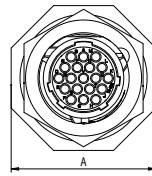

| | A | B | C | D | E | F | L | M |
|----------|-------|-------|-------|-------|-------|-------|-------|-------|
| Shell 10 | 27.00 | 33.00 | 21.10 | 10.00 | 15.00 | 19.30 | 16.40 | 17.30 |
| Shell 12 | 31.80 | 33.00 | 21.10 | 10.00 | 19.00 | 19.30 | 20.70 | 22.00 |
| Shell 14 | 34.90 | 33.00 | 21.10 | 10.00 | 22.20 | 19.30 | 24.00 | 25.20 |
| Shell 16 | 38.10 | 33.00 | 21.10 | 10.00 | 25.30 | 19.30 | 27.00 | 28.30 |
| Shell 18 | 41.30 | 33.00 | 21.10 | 10.00 | 28.55 | 19.30 | 30.00 | 31.60 |
| Shell 20 | 46.10 | 39.00 | 26.50 | 10.00 | 31.70 | 24.70 | 33.80 | 35.20 |

Cord Grips

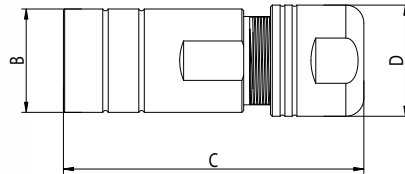

EMC Grounding Ring included

| | Amphenol P/N | Cable Range | A (Thread) | B | C |
|----------|--------------|-------------|-----------------|-------|-------|
| Shell 10 | RTOL-10CG-S1 | 3 to 6.5 | 9/16-24 UNEF | 50.00 | 18.50 |
| | RTOL-10CG-S2 | 5 to 8.5 | | | |
| Shell 12 | RTOL-12CG-S1 | 6 to 10.5 | 11/16-24 UNEF | 54.00 | 23.00 |
| | RTOL-12CG-S2 | 8 to 12.5 | | | |
| Shell 14 | RTOL-14CG-S1 | 6 to 10.5 | 13/16-20 UNEF | 54.00 | 23.00 |
| | RTOL-14CG-S2 | 8 to 12.5 | | | |
| Shell 16 | RTOL-16CG-S1 | 9.5 to 14.5 | 15/16-20 UNEF | 60.00 | 26.50 |
| | RTOL-16CG-S2 | 13.5 to 18 | | | |
| Shell 18 | RTOL-18CG-S1 | 9.5 to 14.5 | 1" 1/16-18 UNEF | 60.00 | 28.20 |
| | RTOL-18CG-S2 | 13.5 to 18 | | | |
| Shell 20 | RTOL-20CG-S1 | 16.5 to 22 | 1" 3/16-18 UNEF | 63.50 | 33.00 |
| | RTOL-20CG-S2 | 21.5 to 24 | | | |

All dimensions are in mm.

Metal Cable Clamp Cord Grip

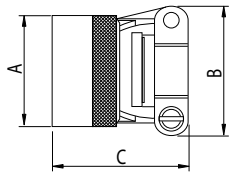

| | Amphenol P/N | Max. Cable Diam. | A (Thread) | B | C |
|----------|--------------|------------------|-----------------|-------|-------|
| Shell 10 | RT10SR | 5.0 | 9/16-24 UNEF | 21.60 | 31.00 |
| Shell 12 | RT12SR | 8.2 | 11/16-24 UNEF | 25.00 | 31.50 |
| Shell 14 | RT14SR | 10.0 | 13/16-20 UNEF | 27.40 | 34.00 |
| Shell 16 | RT16SR | 13.0 | 15/16-20 UNEF | 29.40 | |
| Shell 18 | RT18SR | 16.0 | 1" 1/16-18 UNEF | 35.20 | 31.40 |
| Shell 20 | RT20SR | 21.0 | 1" 3/16-18 UNEF | 37.60 | 32.00 |

Metal Cable Clamp Cord Grip Plating Options Example: RT10SR(); RT10SR1; RT10SR2

(): Standard is nickel plating (48hr salt spray)

1: Black anodized (96hr salt spray)



Wall Mounted Receptacle for Flat Hole Tail

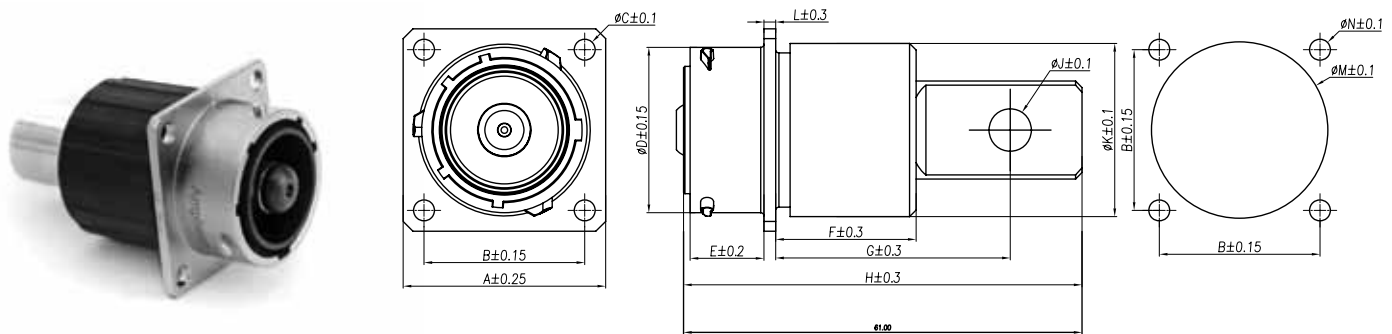

| Amphenol P/N | | A | B | ΦC | ΦD | E | F | G | H | J | K | L | ΦN | ΦM |
|--------------|---------------|-------|-------|------|-------|-------|-------|-------|-------|------|-------|------|------|-------|
| Shell 12 | RTHP0121PN-H1 | 26.80 | 20.60 | 3.20 | 19.00 | 11.35 | 19.60 | 34.00 | 55.10 | 5.50 | 21.80 | 1.80 | 3.20 | 22.50 |
| Shell 14 | RTHP0141PN-H1 | 23.00 | 28.60 | | 22.20 | | 17.20 | 28.50 | 53.10 | 5.50 | 23.90 | | | 24.50 |
| Shell 16 | RTHP0161PN-H1 | 24.60 | 31.00 | | 25.30 | | 21.50 | 35.90 | 61.00 | 6.50 | 26.50 | | | 27.00 |
| Shell 20 | RTHP0201PN-H1 | 29.40 | 26.50 | 4.20 | 31.70 | 14.55 | 22.20 | 40.10 | 72.00 | 8.50 | 33.50 | 2.40 | 4.20 | 34.00 |

Straight Cable Plug with Cord Grip Solutions

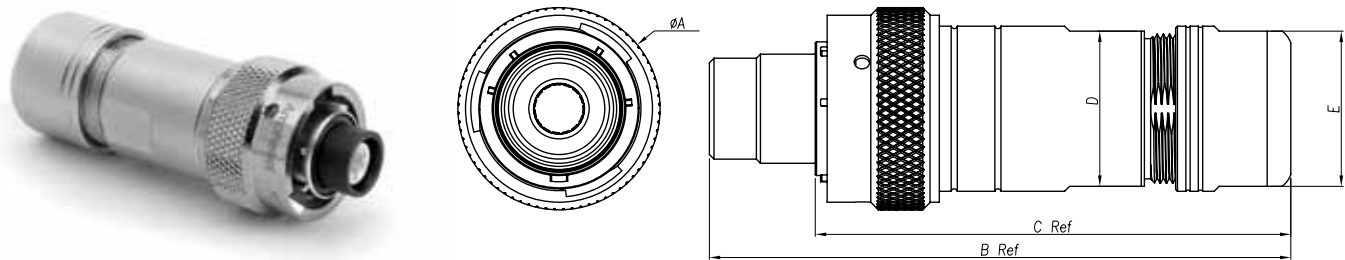

| Amphenol P/N | | A | B | C | D | E | Wire size | Cable max. |
|--------------|------------------|-------|--------|-------|-------|-------|-----------------------|------------|
| Shell 12 | RTHP6121SNH-16S2 | 26.10 | 79.30 | 73.30 | 19.90 | 21.90 | 13-16 mm ² | 12.50 |
| Shell 14 | RTHP6141SNH-25S2 | 29.30 | 86.40 | 72.30 | 19.90 | 21.90 | 20-25 mm ² | 12.50 |
| Shell 16 | RTHP6161SNH-35S2 | 32.50 | 93.30 | 76.30 | 24.90 | 24.90 | 30-35 mm ² | 17.50 |
| Shell 20 | RTHP6201SNH-70S2 | 38.60 | 100.90 | 80.80 | 28.90 | 28.90 | 70-75 mm ² | 20.00 |

All dimensions are in mm.

Straight Cable Plug with End Cap

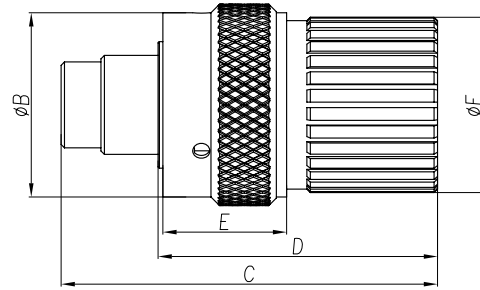
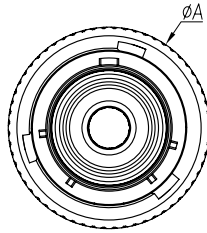

| | Amphenol P/N | A | B | C | D | E | ΦF | Wire size | Cable max. |
|----------|------------------|-------|-------|-------|-------|-------|-------|-----------------------|------------|
| Shell 12 | RTHP6121SNH-16EC | 26.10 | 23.60 | 38.70 | 32.70 | 18.00 | 21.80 | 13-16 mm ² | 12.50 |
| Shell 14 | RTHP6141SNH-25EC | 29.30 | 26.80 | 54.80 | 40.70 | | 25.50 | 20-25 mm ² | 12.50 |
| Shell 16 | RTHP6161SNH-35EC | 32.50 | 30.00 | 57.70 | 40.70 | | 27.50 | 30-35 mm ² | 17.50 |
| Shell 20 | RTHP6201SNH-70EC | 38.60 | 36.60 | 62.70 | 42.70 | 19.00 | 34.50 | 70-75 mm ² | 20.00 |

Straight Cable Plug with 90° Cord Grip Solutions

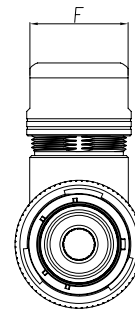
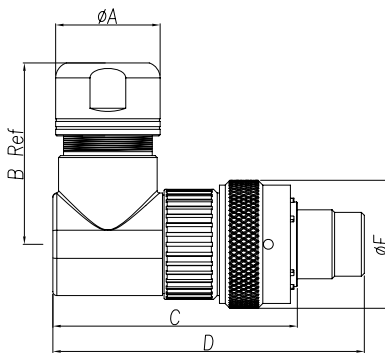

| | Amphenol P/N | A | B | C | D | ΦE | ΦF | Wire size | Cable max. |
|----------|-------------------|-------|-------|-------|-------|-------|-------|-----------------------|------------|
| Shell 12 | RTHP6121SNH-16BS2 | 23.00 | 43.00 | 58.70 | 64.70 | 26.10 | 21.90 | 13-16 mm ² | 12.50 |
| Shell 14 | RTHP6141SNH-25BS2 | 26.50 | 46.00 | 62.00 | 76.10 | 29.30 | 24.90 | 20-25 mm ² | 12.50 |
| Shell 16 | RTHP6161SNH-35BS2 | 26.50 | 46.00 | 62.00 | 79.00 | 29.30 | 24.90 | 30-35 mm ² | 17.50 |
| Shell 20 | RTHP6201SNH-70BS2 | 31.00 | 54.30 | 75.00 | 95.00 | 26.60 | 29.00 | 70-75 mm ² | 20.00 |

Accessories & Tooling

Dust Caps

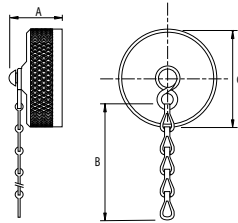

Sealing Plugs



| | Amphenol P/N | A max. | B | C max. |
|----------|--------------|--------|-------|--------|
| Shell 10 | RT010DCG | 21.80 | 42.00 | 30.20 |
| Shell 12 | RT012DCG | 24.60 | | |
| Shell 14 | RT014DCG | 27.80 | | |
| Shell 16 | RT016DCG | 31.00 | | |
| Shell 18 | RT018DCG | 35.30 | | |
| Shell 20 | RT020DCG | 38.60 | | |

| | Amphenol P/N | mm |
|-------|--------------|------|
| 16AWG | CA-4016-59 | 1.50 |
| 20AWG | CA-4020-59 | 0.50 |

Stamp Contact Tool

(Stamped and Formed Contacts)



| | Amphenol P/N |
|-------|--------------|
| 16AWG | MFX-3954 |
| 20AWG | MFX-3958 |
| 2.5mm | MFX-3962 |

Universal Hand Crimp Tool

(Machined Contacts)



| | Amphenol P/N |
|--|--------------|
| | MFX-3959 |

Contact Extraction Tool



| | Amphenol P/N |
|-------|--------------|
| 16AWG | QXRT16 |
| 20AWG | QXRT20 |
| 2.5mm | QXRT12S |

All dimensions are in mm.

Crimp Die (Stamped and Formed Contacts)



| Amphenol P/N | |
|--------------|----------|
| 16AWG | MFX-3957 |
| 20AWG | MFX-3964 |
| 2.5mm | MFX-3965 |

Pneumatic Crimp Tool (Machined Contacts)



| Amphenol P/N |
|--------------|
| MFX-3960 |

Gaskets

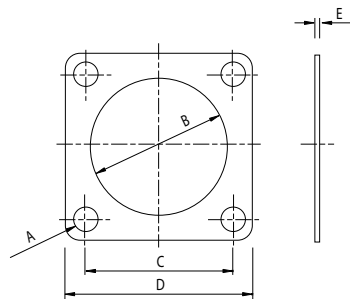

| Amphenol P/N | | $\text{Ø}A \pm 0.1$ | $\text{Ø}B \pm 0.01$ | $C \pm 0.25$ | $D \pm 0.25$ | $E \pm 0.2$ |
|--------------|---------|---------------------|----------------------|--------------|--------------|-------------|
| Shell 10 | RTFD10B | 3.30 | 15.90 | 18.30 | 23.80 | 0.80 |
| Shell 12 | RTFD12B | | 19.00 | 20.60 | 26.20 | |
| Shell 14 | RTFD14B | | 22.20 | 23.00 | 28.60 | |
| Shell 16 | RTFD16B | | 25.40 | 24.60 | 31.00 | |
| Shell 18 | RTFD18B | | 28.60 | 27.00 | 33.30 | |
| Shell 20 | RTFD20B | | 31.80 | 29.40 | 36.50 | |

Gasket material is NBR. For other options, please consult factory.

NORTH AMERICA

Amphenol Sine Systems MICHIGAN

44724 Morley Drive
Clinton Township, MI 48036
Toll-Free: 1-800-394-7732
Fax: 1-586-465-1216
Email: sine_info@sineco.com

EUROPE

Amphenol Air LB

29, voie d' Yvois
F-08110 Blagny, France
Phone: 33-3-2422-7849
Fax: 33-3-2422-7875
Email: accueil@amphenol-airlb.fr

Amphenol AIR LB GmbH

Am Kleinbahnhof 4
Saarlouis D-66740, Germany
Phone: 49-6831-981-00
Fax: 49-6831-981-030
Email: info@amphenol-airlb.de

Amphenol BENELUX

Zadelmaker 121
NL-2401PD Alphen aan den Rijn
The Netherlands
Phone: (31) 172 444903
Fax: (31) 172 240254
E-mail: info@amphenol-nl.com

Amphenol CENTER EAST EUROPE, POLAND and AUSTRIA

Wiener Gasse 68
2380 Perchtoldsdorf, Austria
Phone: 43-699-10396071
Fax: 43-699-40396071
Email: c.czesch@amphenol-roe.eu

ASIA

Amphenol Sine Systems CHINA

2/F Building A5, Hua Feng Technology Park
Guan Tian, Bei Huan Road, Shi Yan Street
Bao An District, Shenzhen, China 518108
Tel: 86-755-8173-8000 ext. 8098
Fax: 86-755-8173-8180
Email: fount.nee@amphenolpcd.com.cn

Amphenol INTERCONNECT INDIA PRIVATE LTD

105 Bhosari Industrial Area
Pune 411 026, India
Phone: 91-20-712-0363/0463/0155
Fax: 91-20-712-0581

OTHER LOCATIONS

Amphenol MEXICO

Prolongacion Reforma 61-6 B2
Col. Paseo de las Lomas
C.P. 01330 Mexico DF, Mexico
Phone: 52-55-5258-9984
Fax: 52-55-5081-6890
Email: www.amphenolmexico.com

Amphenol ARGENTINA

Avenida Callao 930
2nd floor Office B Plaza
C1023AAP Buenos Aires, Argentina
Phone: 54-11-4815-6886
Fax: 54-11-4814-5779

Amphenol BRASIL LTDA

Rua Diogo Moreira, 132
20 Andar, Rooms 2001-2-3
CEP 05423-101
Sao Paulo- SP, Brazil
Phone: 55-11-3815-1003
Fax: 55-11-3815-1629
Email: vendas@amphenol.com.br

Amphenol ESPANA

Edificio Burgosal, Oficina N 55
C/Comunidad de Madrid, 35 bis
Las Rozas (Madrid), 28230
Phone: 34-91-6407302
Mobile: 34-629054629
Fax: 34-91-6407307
Email: e.bendix@amphenol-roe.eu

Amphenol ITALIA

Via Barbaiana 5
20020 Lainate, Milano, Italy
Phone: 39-02-932541
Fax: 39-02-9325444
Email: r.buscone@amphenol-roe.eu

Amphenol NORDIC

Appelboms vag 2
SE-18642 Vallentuna, Sweden
Phone: 46-76-8418600
Fax: 46-70-2203197
Email: f.weden@amphenol-roe.eu

Amphenol SOCAPEX

948, Promenade de l'Arve - BP 29
74311 Thyez CEDEX, France
Phone: 33(0)4-50-89-28-40
Fax: 33(0)4-50-96-29-75
Email: jocelyne.anthoine@amphenol-socapex.fr

Amphenol DAESHIN

558, Songnae-2 Dong, SoSa-Gu
Bucheon City, Gyeonggi-do, Korea 422-818
Phone: 81-32-610-3800
Fax: 81-32-673-2507
Email: info@amphenol.co.kr

Amphenol JAPAN

471-1, Deba, Ritto-city
shiga 520-3041, Japan
Phone: 81-77-553-8501
Fax: 81-77-551-2200

Amphenol SOUTH AFRICA

30 Impala Road
2196 Sandton, Chislehurst
South Africa
Phone: 27-11-783-9517
Fax: 27-11-783-9519
Email: amphenol_africa@csi.com

Amphenol AUSTRALIA PTY LIMITED

2 Fiveways Blvd., Keysborough
Melbourne, Victoria 3173 Australia
Phone: 613-8796-8888
Fax: 613-8796-8801

Amphenol TURKEY

Ayazaga Mah. Meyden Sk. No. 28
Beybi Giz Plaza, Kat. 26
34396 Maslak/Istanbul, Turkey
Phone: 90-212-335-2501
Fax: 90-212-335-25-00

Amphenol SWITZERLAND & SOUTH CENTER EUROPE

Switzerland, Slovenia, Serbia, Montenegro,
Yugoslavia, Greece, Bulgaria
948, Promenade de l'Arve - BP29
74311 Thyez - France
Phone: 33-4-50-89-28-00
Fax: 33-4-50-96-29-75

Amphenol TUCHEL GmbH

August-Haeusser-Strasse 10
Heilbronn, 74080
Germany
Phone: 49(0)-7131-929-0
Fax: 49(0)-7131-929-486
Email: info@amphenol.de

Amphenol LIMITED

Thanet Way, Whitstable
Kent CT5 3JF, United Kingdom
Phone: 44-1-227-773200
Fax: 44-1-227-276571

Amphenol TERRIER TECHNOLOGIES

Unif 14, Northlake Industrial Park
Malcolm Moodie Crescent, Jet Park
Gauteng, South Africa
Phone: 27-11-397-6069
Fax: 27-11-397-8874

Amphenol BAR TEC LTD

4 Hagavish St., PO Box 279
Kfar Saba 44102, Israel
Phone: 972-9-767-4097
Fax: 972-9-767-4324

Amphenol RUSSIA

8 Yaroslavskaja Street
Floor 2 129164 Moscow, Russia
Phone: 7495-937-6341
Fax: 7495-937-6319
Email: russia@amphenol.com



Стандарт Электрон Связь

Мы молодая и активно развивающаяся компания в области поставок электронных компонентов. Мы поставляем электронные компоненты отечественного и импортного производства напрямую от производителей и с крупнейших складов мира.

Благодаря сотрудничеству с мировыми поставщиками мы осуществляем комплексные и плановые поставки широчайшего спектра электронных компонентов.

Собственная эффективная логистика и склад в обеспечивает надежную поставку продукции в точно указанные сроки по всей России.

Мы осуществляем техническую поддержку нашим клиентам и предпродажную проверку качества продукции. На все поставляемые продукты мы предоставляем гарантию .

Осуществляем поставки продукции под контролем ВП МО РФ на предприятия военно-промышленного комплекса России , а также работаем в рамках 275 ФЗ с открытием отдельных счетов в уполномоченном банке. Система менеджмента качества компании соответствует требованиям ГОСТ ISO 9001.

Минимальные сроки поставки, гибкие цены, неограниченный ассортимент и индивидуальный подход к клиентам являются основой для выстраивания долгосрочного и эффективного сотрудничества с предприятиями радиоэлектронной промышленности, предприятиями ВПК и научно-исследовательскими институтами России.

С нами вы становитесь еще успешнее!

Наши контакты:

Телефон: +7 812 627 14 35

Электронная почта: sales@st-electron.ru

Адрес: 198099, Санкт-Петербург,
Промышленная ул, дом № 19, литера Н,
помещение 100-Н Офис 331