



PMBT3906

PNP switching transistor

Rev. 06 — 2 March 2010

Product data sheet

1. Product profile

1.1 General description

PNP switching transistor in a SOT23 (TO-236AB) small Surface-Mounted Device (SMD) plastic package.

NPN complement: PMBT3904.

1.2 Features and benefits

- Collector-emitter voltage $V_{CEO} = -40$ V
- Collector current capability $I_C = -200$ mA

1.3 Applications

- General amplification and switching

1.4 Quick reference data

Table 1. Quick reference data

Symbol	Parameter	Conditions	Min	Typ	Max	Unit
V_{CEO}	collector-emitter voltage	open base	-	-	-40	V
I_C	collector current		-	-	-200	mA

2. Pinning information

Table 2. Pinning

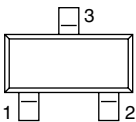
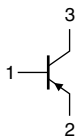
Pin	Description	Simplified outline	Graphic symbol
1	base		
2	emitter		
3	collector		

006aab25!

3. Ordering information

Table 3. Ordering information

Type number	Package		
	Name	Description	Version
PMBT3906	-	plastic surface-mounted package; 3 leads	SOT23

4. Marking

Table 4. Marking codes

Type number	Marking code ^[1]
PMBT3906	*2A

- [1] * = -: made in Hong Kong
 * = p: made in Hong Kong
 * = t: made in Malaysia
 * = W: made in China

5. Limiting values

Table 5. Limiting values

In accordance with the Absolute Maximum Rating System (IEC 60134).

Symbol	Parameter	Conditions	Min	Max	Unit
V_{CBO}	collector-base voltage	open emitter	-	-40	V
V_{CEO}	collector-emitter voltage	open base	-	-40	V
V_{EBO}	emitter-base voltage	open collector	-	-6	V
I_C	collector current		-	-200	mA
I_{CM}	peak collector current		-	-200	mA
I_{BM}	peak base current		-	-100	mA
P_{tot}	total power dissipation	$T_{amb} \leq 25\text{ °C}$	^[1] -	250	mW
T_j	junction temperature		-	150	°C
T_{amb}	ambient temperature		-65	+150	°C
T_{stg}	storage temperature		-65	+150	°C

- [1] Device mounted on an FR4 Printed-Circuit Board (PCB).

6. Thermal characteristics

Table 6. Thermal characteristics

Symbol	Parameter	Conditions	Min	Typ	Max	Unit
$R_{th(j-a)}$	thermal resistance from junction to ambient	in free air	[1]	-	500	K/W

[1] Device mounted on an FR4 PCB.

7. Characteristics

Table 7. Characteristics

$T_{amb} = 25\text{ °C}$ unless otherwise specified.

Symbol	Parameter	Conditions	Min	Typ	Max	Unit
I_{CBO}	collector-base cut-off current	$V_{CB} = -30\text{ V}; I_E = 0\text{ A}$	-	-	-50	nA
I_{EBO}	emitter-base cut-off current	$V_{EB} = -6\text{ V}; I_C = 0\text{ A}$	-	-	-50	nA
h_{FE}	DC current gain	$V_{CE} = -1\text{ V}$				
		$I_C = -0.1\text{ mA}$	60	-	-	
		$I_C = -1\text{ mA}$	80	-	-	
		$I_C = -10\text{ mA}$	100	-	300	
		$I_C = -50\text{ mA}$	60	-	-	
V_{CEsat}	collector-emitter saturation voltage	$I_C = -10\text{ mA}; I_B = -1\text{ mA}$	-	-	-250	mV
		$I_C = -50\text{ mA}; I_B = -5\text{ mA}$	-	-	-400	mV
V_{BEsat}	base-emitter saturation voltage	$I_C = -10\text{ mA}; I_B = -1\text{ mA}$	-	-	-850	mV
		$I_C = -50\text{ mA}; I_B = -5\text{ mA}$	-	-	-950	mV
t_d	delay time	$I_{Con} = -10\text{ mA};$ $I_{Bon} = -1\text{ mA};$ $I_{Boff} = 1\text{ mA}$	-	-	35	ns
t_r	rise time		-	-	35	ns
t_{on}	turn-on time		-	-	70	ns
t_s	storage time		-	-	225	ns
t_f	fall time		-	-	75	ns
t_{off}	turn-off time		-	-	300	ns
f_T	transition frequency	$V_{CE} = -20\text{ V};$ $I_C = -10\text{ mA};$ $f = 100\text{ MHz}$	250	-	-	MHz
C_C	collector capacitance	$V_{CB} = -5\text{ V}; I_E = I_C = 0\text{ A};$ $f = 1\text{ MHz}$	-	-	4.5	pF
C_e	emitter capacitance	$V_{EB} = -500\text{ mV};$ $I_C = I_E = 0\text{ A}; f = 1\text{ MHz}$	-	-	10	pF
NF	noise figure	$I_C = -100\text{ }\mu\text{A};$ $V_{CE} = -5\text{ V}; R_S = 1\text{ k}\Omega;$ $f = 10\text{ Hz to }15.7\text{ kHz}$	-	-	4	dB

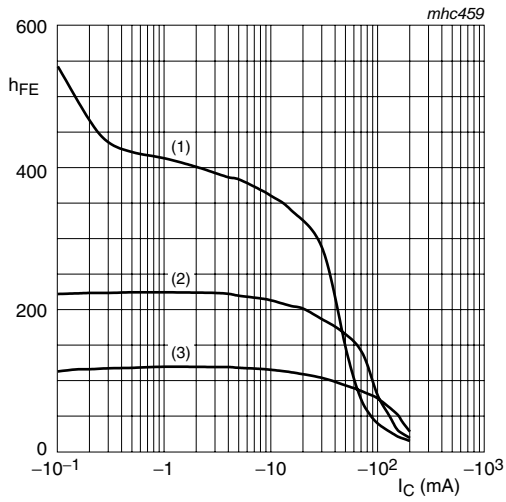

$V_{CE} = -1\text{ V}$
 (1) $T_{amb} = 150\text{ °C}$
 (2) $T_{amb} = 25\text{ °C}$
 (3) $T_{amb} = -55\text{ °C}$

Fig 1. DC current gain as a function of collector current; typical values

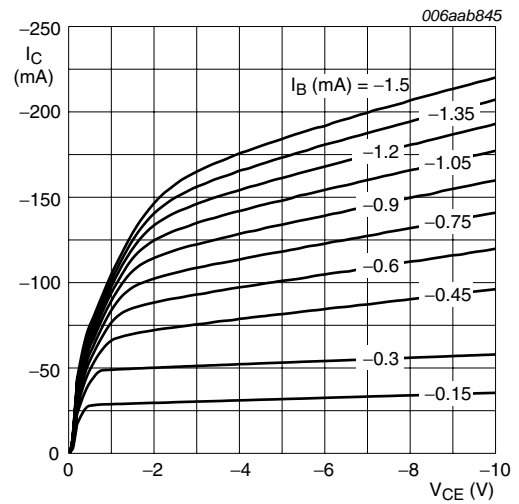

$T_{amb} = 25\text{ °C}$

Fig 2. Collector current as a function of collector-emitter voltage; typical values

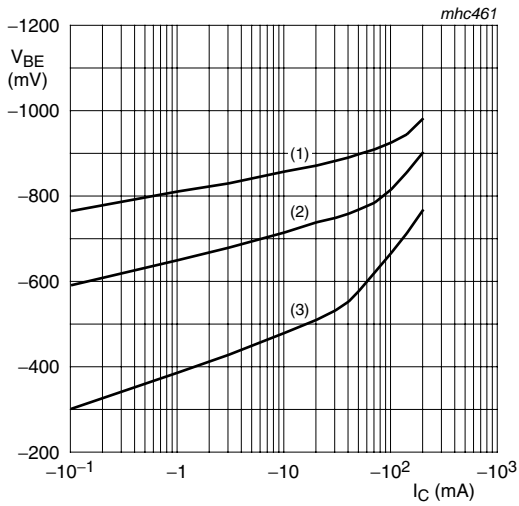

$V_{CE} = -1\text{ V}$
 (1) $T_{amb} = -55\text{ °C}$
 (2) $T_{amb} = 25\text{ °C}$
 (3) $T_{amb} = 150\text{ °C}$

Fig 3. Base-emitter voltage as a function of collector current; typical values

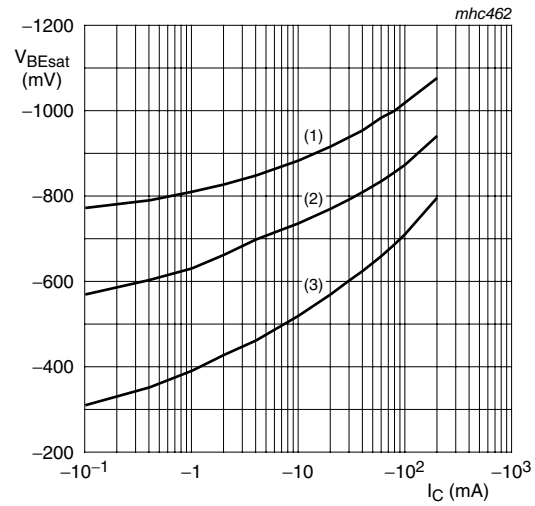

$I_C/I_B = 10$
 (1) $T_{amb} = -55\text{ °C}$
 (2) $T_{amb} = 25\text{ °C}$
 (3) $T_{amb} = 150\text{ °C}$

Fig 4. Base-emitter saturation voltage as a function of collector current; typical values

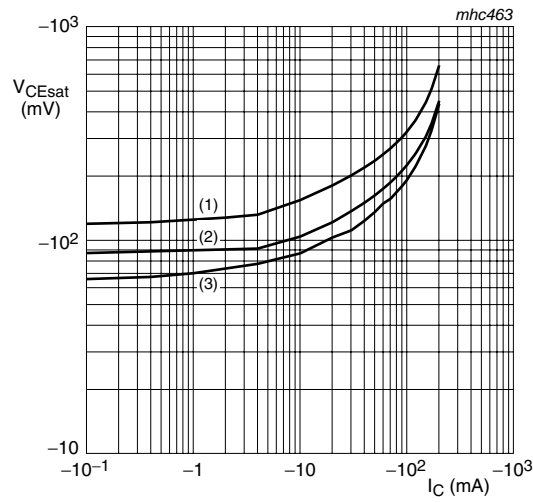

- $I_C/I_B = 10$
- (1) $T_{amb} = 150\text{ °C}$
 - (2) $T_{amb} = 25\text{ °C}$
 - (3) $T_{amb} = -55\text{ °C}$

Fig 5. Collector-emitter saturation voltage as a function of collector current; typical values

8. Test information

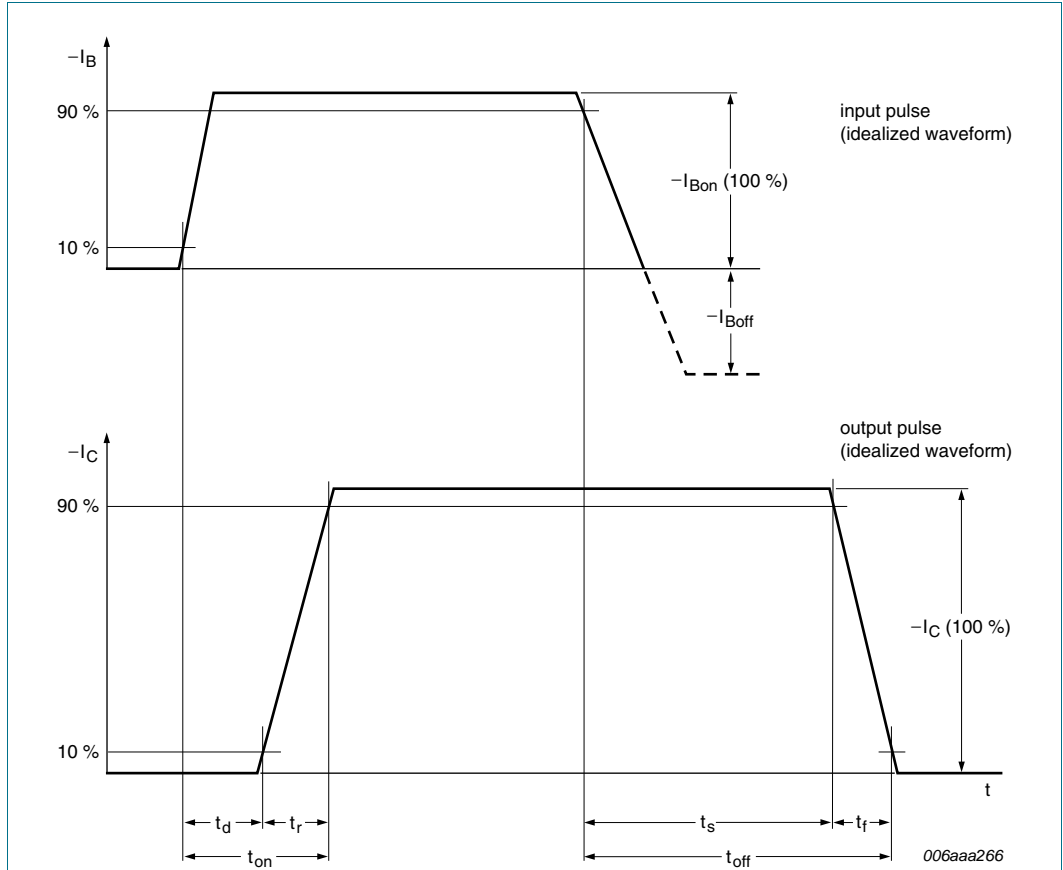
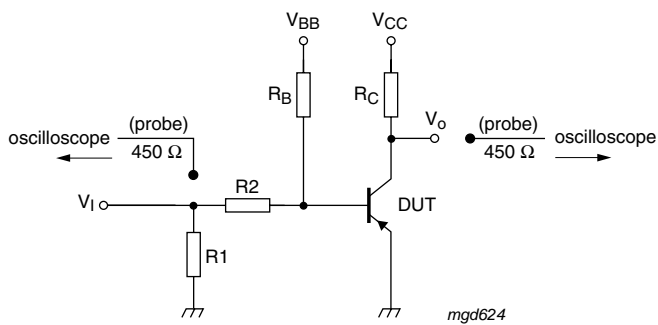

Fig 6. BISS transistor switching time definition



$V_I = 5 \text{ V}$; $T = 500 \text{ } \mu\text{s}$; $t_p = 10 \text{ } \mu\text{s}$; $t_r = t_f \leq 3 \text{ ns}$
 $R1 = 56 \text{ } \Omega$; $R2 = 2.5 \text{ k}\Omega$; $R_B = 3.9 \text{ k}\Omega$; $R_C = 270 \text{ } \Omega$
 $V_{BB} = 1.9 \text{ V}$; $V_{CC} = -3 \text{ V}$
 Oscilloscope: input impedance $Z_i = 50 \text{ } \Omega$

Fig 7. Test circuit for switching times

9. Package outline

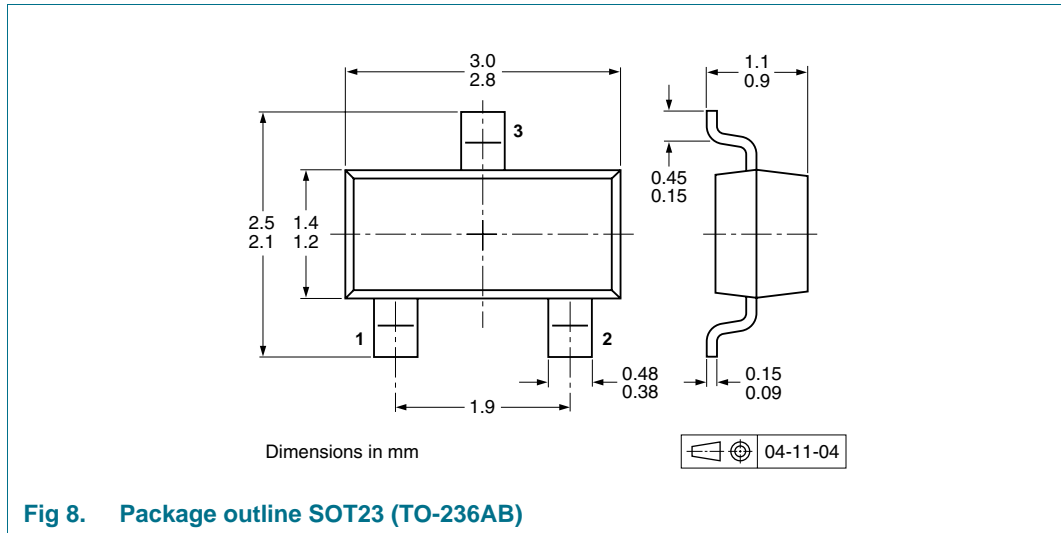

10. Packing information

Table 8. Packing methods

The indicated -xxx are the last three digits of the 12NC ordering code.^[1]

Type number	Package	Description	Packing quantity	
			3000	10000
PMBT3906	SOT23	4 mm pitch, 8 mm tape and reel	-215	-235

[1] For further information and the availability of packing methods, see [Section 13](#).

11. Revision history

Table 9. Revision history

Document ID	Release date	Data sheet status	Change notice	Supersedes
PMBT3906_6	20100302	Product data sheet	-	PMBT3906_N_5
Modifications:	<ul style="list-style-type: none"> • The format of this data sheet has been redesigned to comply with the new identity guidelines of NXP Semiconductors. • Legal texts have been adapted to the new company name where appropriate. • Section 4 “Marking”: amended • Table 7 “Characteristics”: F redefined to NF noise figure • Section 8 “Test information”: added • Figure 6: added • Figure 8: superseded by minimized package outline drawing • Section 10 “Packing information”: added • Section 12 “Legal information”: updated 			
PMBT3906_N_5	20071004	Product data sheet	-	PMBT3906_4
PMBT3906_4	20040121	Product specification	-	PMBT3906_3
PMBT3906_3	19990427	Product specification	-	PMBT3906_CNV_2
PMBT3906_CNV_2	19970505	Product specification	-	-

12. Legal information

12.1 Data sheet status

Document status ^{[1][2]}	Product status ^[3]	Definition
Objective [short] data sheet	Development	This document contains data from the objective specification for product development.
Preliminary [short] data sheet	Qualification	This document contains data from the preliminary specification.
Product [short] data sheet	Production	This document contains the product specification.

[1] Please consult the most recently issued document before initiating or completing a design.

[2] The term 'short data sheet' is explained in section "Definitions".

[3] The product status of device(s) described in this document may have changed since this document was published and may differ in case of multiple devices. The latest product status information is available on the Internet at URL <http://www.nexperia.com>.

12.2 Definitions

Draft — The document is a draft version only. The content is still under internal review and subject to formal approval, which may result in modifications or additions. Nexperia does not give any representations or warranties as to the accuracy or completeness of information included herein and shall have no liability for the consequences of use of such information.

Short data sheet — A short data sheet is an extract from a full data sheet with the same product type number(s) and title. A short data sheet is intended for quick reference only and should not be relied upon to contain detailed and full information. For detailed and full information see the relevant full data sheet, which is available on request via the local Nexperia sales office. In case of any inconsistency or conflict with the short data sheet, the full data sheet shall prevail.

Product specification — The information and data provided in a Product data sheet shall define the specification of the product as agreed between Nexperia and its customer, unless Nexperia and customer have explicitly agreed otherwise in writing. In no event however, shall an agreement be valid in which the Nexperia product is deemed to offer functions and qualities beyond those described in the Product data sheet.

12.3 Disclaimers

Limited warranty and liability — Information in this document is believed to be accurate and reliable. However, Nexperia does not give any representations or warranties, expressed or implied, as to the accuracy or completeness of such information and shall have no liability for the consequences of use of such information.

In no event shall Nexperia be liable for any indirect, incidental, punitive, special or consequential damages (including - without limitation - lost profits, lost savings, business interruption, costs related to the removal or replacement of any products or rework charges) whether or not such damages are based on tort (including negligence), warranty, breach of contract or any other legal theory.

Notwithstanding any damages that customer might incur for any reason whatsoever, Nexperia's aggregate and cumulative liability towards customer for the products described herein shall be limited in accordance with the *Terms and conditions of commercial sale* of Nexperia.

Right to make changes — Nexperia reserves the right to make changes to information published in this document, including without limitation specifications and product descriptions, at any time and without notice. This document supersedes and replaces all information supplied prior to the publication hereof.

Suitability for use — Nexperia products are not designed, authorized or warranted to be suitable for use in medical, military, aircraft, space or life support equipment, nor in applications where failure or

malfunction of a Nexperia product can reasonably be expected to result in personal injury, death or severe property or environmental damage. Nexperia accepts no liability for inclusion and/or use of Nexperia products in such equipment or applications and therefore such inclusion and/or use is at the customer's own risk.

Applications — Applications that are described herein for any of these products are for illustrative purposes only. Nexperia makes no representation or warranty that such applications will be suitable for the specified use without further testing or modification.

Nexperia does not accept any liability related to any default, damage, costs or problem which is based on a weakness or default in the customer application/use or the application/use of customer's third party customer(s) (hereinafter both referred to as "Application"). It is customer's sole responsibility to check whether the Nexperia product is suitable and fit for the Application planned. Customer has to do all necessary testing for the Application in order to avoid a default of the Application and the product. Nexperia does not accept any liability in this respect.

Limiting values — Stress above one or more limiting values (as defined in the Absolute Maximum Ratings System of IEC 60134) will cause permanent damage to the device. Limiting values are stress ratings only and (proper) operation of the device at these or any other conditions above those given in the Recommended operating conditions section (if present) or the Characteristics sections of this document is not warranted. Constant or repeated exposure to limiting values will permanently and irreversibly affect the quality and reliability of the device.

Terms and conditions of commercial sale — Nexperia products are sold subject to the general terms and conditions of commercial sale, as published at <http://www.nexperia.com/profile/terms>, unless otherwise agreed in a valid written individual agreement. In case an individual agreement is concluded only the terms and conditions of the respective agreement shall apply. Nexperia hereby expressly objects to applying the customer's general terms and conditions with regard to the purchase of Nexperia products by customer.

No offer to sell or license — Nothing in this document may be interpreted or construed as an offer to sell products that is open for acceptance or the grant, conveyance or implication of any license under any copyrights, patents or other industrial or intellectual property rights.

Export control — This document as well as the item(s) described herein may be subject to export control regulations. Export might require a prior authorization from national authorities.

Quick reference data — The Quick reference data is an extract of the product data given in the Limiting values and Characteristics sections of this document, and as such is not complete, exhaustive or legally binding.

12.4 Trademarks

Notice: All referenced brands, product names, service names and trademarks are the property of their respective owners.

13. Contact information

For more information, please visit: <http://www.nexperia.com>

For sales office addresses, please send an email to: salesaddresses@nexperia.com

14. Contents

1	Product profile	1
1.1	General description	1
1.2	Features and benefits	1
1.3	Applications	1
1.4	Quick reference data	1
2	Pinning information	1
3	Ordering information	2
4	Marking	2
5	Limiting values	2
6	Thermal characteristics	3
7	Characteristics	3
8	Test information	6
9	Package outline	7
10	Packing information	7
11	Revision history	8
12	Legal information	9
12.1	Data sheet status	9
12.2	Definitions	9
12.3	Disclaimers	9
12.4	Trademarks	9
13	Contact information	10
14	Contents	11



Стандарт Электрон Связь

Мы молодая и активно развивающаяся компания в области поставок электронных компонентов. Мы поставляем электронные компоненты отечественного и импортного производства напрямую от производителей и с крупнейших складов мира.

Благодаря сотрудничеству с мировыми поставщиками мы осуществляем комплексные и плановые поставки широчайшего спектра электронных компонентов.

Собственная эффективная логистика и склад в обеспечивает надежную поставку продукции в точно указанные сроки по всей России.

Мы осуществляем техническую поддержку нашим клиентам и предпродажную проверку качества продукции. На все поставляемые продукты мы предоставляем гарантию .

Осуществляем поставки продукции под контролем ВП МО РФ на предприятия военно-промышленного комплекса России , а также работаем в рамках 275 ФЗ с открытием отдельных счетов в уполномоченном банке. Система менеджмента качества компании соответствует требованиям ГОСТ ISO 9001.

Минимальные сроки поставки, гибкие цены, неограниченный ассортимент и индивидуальный подход к клиентам являются основой для выстраивания долгосрочного и эффективного сотрудничества с предприятиями радиоэлектронной промышленности, предприятиями ВПК и научно-исследовательскими институтами России.

С нами вы становитесь еще успешнее!

Наши контакты:

Телефон: +7 812 627 14 35

Электронная почта: sales@st-electron.ru

Адрес: 198099, Санкт-Петербург,
Промышленная ул, дом № 19, литера Н,
помещение 100-Н Офис 331