

Product Description

The QORVO TGC4510-SM is a K-Band image reject upconverter mixer with integrated x2 LO buffer amplifier and output variable gain amplifier. The TGC4510-SM outputs an RF frequency from 17.7 to 26.5 GHz using IF inputs from DC to 4.0 GHz and a corresponding LO frequency. It is designed using QORVO's pHEMT production process.

The TGC4510-SM typically provides 32 dBm of output TOI at -10 dBm input power per tone and has a conversion gain of 13 dB. Optional nulling of the LO can improve LO Isolation by 30 dB.

The TGC4510-SM is available in a low-cost, surface mount 28 lead 5x5mm QFN package and is ideally suited for Point-to-Point Radio, and K-Band VSAT Ground Terminal.

Lead-free and RoHS compliant.

Function Block Diagram

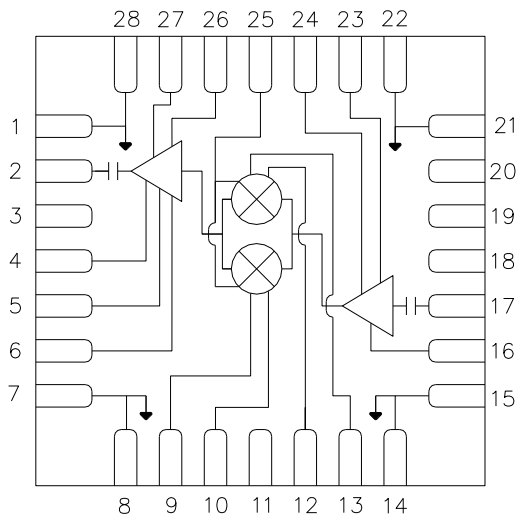

Applications

- VSAT Ground Terminal
- Point-to-Point Radio
- Millimeter Wave Communications

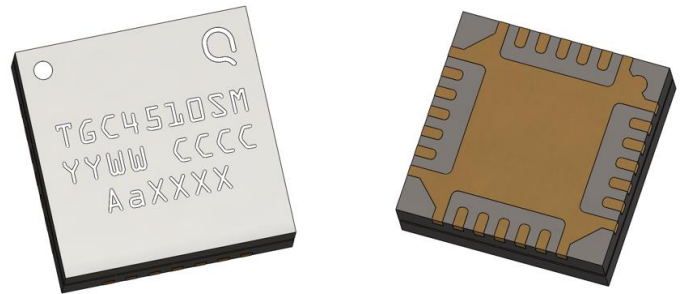

28-pin 5x5 mm QFN package

Product Features

- RF Frequency Range: 17.7 – 26.5 GHz
- IF Frequency: DC – 4.0 GHz
- LO Frequency: 6.85 – 15.25 GHz
- LO Input Power: 2 to 10 dBm
- Conversion Gain: 13 dB
- OTOI: 32 dBm at max gain
- Attenuation Range: 30 dB typical
- Bias 5.0 V, 360 mA, 3.3 V, 180 mA
- Package Dimensions: 5.0 x 5.0 x 1.3 mm

Performance is typical across frequency. Please reference electrical specification table and data plots for more details.

Ordering Information

| Part No. | Description |
|------------------|---|
| TGC4510-SM | Ku-Band Upconverter |
| 1119047 | Shipping Tray, Qty 50 |
| 1098636 | Tape and Reel, Qty 500 |
| TGC4510-SMEVBLL | TGC4510-SM EVB LSB, Low IF Band, 1.3 to 2.45 GHz |
| TGC4510-SMEVBLH | TGC4510-SM EVB LSB, High IF Band, 2.5 to 4.0 GHz |
| TGC4510-SMEVBUL | TGC4510-SM EVB USB, Low IF Band, 1.3 to 2.45 GHz |
| TGC4510-SMEVBULH | TGC4510-SM EVB USB, High IF Band, 2.5 to 4.0 GHz |

Absolute Maximum Ratings

| Parameter | Rating | Parameter | Rating |
|---------------------|--------------|---------------------------------------|--------------|
| VDRF, VDLO1, VDLO23 | + 6 V | LO Nulling DC Voltage at IF1, IF2 | -2 to +2 V |
| IDRF | 390 mA | Input Power at LO Port, 50Ω, T = 25°C | 15 dBm |
| IDLO1 | 190 mA | Input Power at IF Port, 50Ω, T = 25°C | 18 dBm |
| IDLO23 | 300 mA | Power Dissipation, Pdiss | 2 W |
| VGRF, VGLO, VGX | -3 to +1.5 V | Channel Temperature, Tch | 200 °C |
| VCTRL1, VCTRL2 | + 3 to 0 V | Storage Temperature | -65 to 125°C |

These are stress ratings only, functional operation of the device at these conditions is not implied. Extended application of Absolute Maximum Rating conditions may reduce device reliability. Operation of this device outside the parameter ranges given above may cause permanent damage.

Recommended Operating Conditions

| Parameter ¹ | Min | Typ | Max | Units | Parameter ¹ | Min | Typ. | Max | Units |
|------------------------|-----|-------|-----|-------|--|-----|------|-----|-------|
| Operating Temp. Range | -40 | +25 | +85 | °C | VGLO ³ | | -0.7 | | V |
| VDRF | | 5 | | V | VCTRL1, VCTRL2 (max gain) ⁴ | -2 | | 0 | V |
| VGRF ² | | -0.75 | | V | VCTRL1, VCTRL2 (min gain) ⁴ | 0 | | -2 | V |
| IDRF | | 360 | | mA | Vi, Vq ⁵ | -1 | | 1 | V |
| VDLO1, VDLO23 | | 3.3 | | V | VGX | | -1.2 | | V |
| IDLO1 + IDLO23 | 140 | 180 | 200 | mA | LO Input Power | 3 | 6 | 9 | dBm |

- 1 Electrical specification are measured at specified test conditions. Specifications are not guaranteed over all recommended operating conditions.
- 2 VGRF value is typical, can be adjusted to get required IDRF.
- 3 VGLO value is typical, can be adjusted to get required IDLO1+IDLO23.
- 4 VCTRL1 and VCTRL2 can be adjusted to achieve required conversion gain.
- 5 Vi and Vq can be adjusted to achieve required LO isolations, optional.

Electrical Specifications

Test conditions unless otherwise noted: VDLO1, VDLO23 = + 3.3 V, VGLO = -0.7 V, IDLO1 + IDLO23 = 140 to 200 mA, VDRF = 5.0 V, VGRF = - 0.75 V, IDRf = 340 to 380 mA, VGX = -1.2 V, T = 25 °C

| Parameter | Conditions | Min | Typ | Max | Units |
|-------------------------|--|------|-----|-------|-------|
| RF Frequency Range | | 17.7 | | 26.5 | GHz |
| LO Frequency Range | | 6.85 | | 15.25 | GHz |
| IF Frequency Range | | 0 | | 4 | GHz |
| Conversion Gain | 1/ 17.7 GHz to 26.5 GHz | | 13 | | dB |
| Conversion Gain | 1/ 17.7 GHz to 23.6 GHz | 9.5 | 13 | 17.5 | dB |
| Attenuation Range | 2/ | | 34 | | dB |
| SSB Noise Figure | | | 15 | | dB |
| OIP3 | 17.7 GHz to 26.5 GHz | 27.5 | 32 | | dBm |
| OIP3 | 17.7 GHz to 23.6 GHz | 27.5 | 32 | | dBm |
| IIP3 at Minimum Gain | | | 13 | | dBm |
| Image Rejection | | | 15 | | dB |
| LO Isolation at RF Port | 3/ Without external LO nulling voltage | | -5 | | dB |
| LO Isolation at RF Port | 3/ With external LO nulling voltage | | 25 | | dB |
| LO Return Loss | | | 12 | | dB |
| RF Return Loss | | | 11 | | dB |

Notes:

1/ At Maximum gain.

2/ Maximum gain at VCTL1 = -2 V, VCTL2 = 0 V; Minimum gain at VCTL1 = 0 V, VCTL2 = -2 V

3/ LO Isolation = (Input Power at LO Port at LO Frequency) – (Output Power at RF port at 2xLO frequency)

Frequency Mapping

| Lower Side Band Frequency Ranges | | |
|----------------------------------|----------------|----------------|
| IF Freq GHz | LO Freq GHz | RF Freq GHz |
| 0.5 | 9-14 | 17.5-27.5 |
| 1.0 | 9-14 | 17-27 |
| 2.0 | 9-14 | 16-26 |
| 3.0 | 10-15 | 17-27 |
| 3.3 | 10-15.5 | 16.7-27.7 |
| 4.0 | 10-16 | 16-28 |

| Upper Side Band Frequency Ranges | | |
|----------------------------------|----------------|----------------|
| IF Freq GHz | LO Freq GHz | RF Freq GHz |
| 0.5 | 8-14 | 16.5-28.5 |
| 1.0 | 8-13 | 17-28 |
| 2.0 | 7-13 | 16-28 |
| 3.0 | 6.5-12 | 16-27 |
| 3.3 | 6.5-12 | 16.3-27.3 |
| 4.0 | 6.5-11 | 17-26 |

| State | VCTRL1 V | VCTRL2 V |
|--------------|-------------|-------------|
| Max Gain | -2 | 0 |
| Reduced Gain | -1.0 | -1.0 |
| Min Gain | 0 | -2 |

Thermal and Reliability Information

| Parameter | Conditions | Rating |
|---|--|-------------------------------------|
| Thermal Resistance, θ_{JC} , measured to back of package | Tbase = 85 °C | θ_{JC} = 19.6 °C/W |
| Channel Temperature (Tch), and Median Lifetime (Tm) | Tbase = 85 °C, VDLO = 3.0 V, IDLO=260 mA, VDRF = 5.0 V, IDRF=360 mA, P _{diss} = 2.6 W | Tch = 136 °C Tm = 5.2 E+06 Hours |

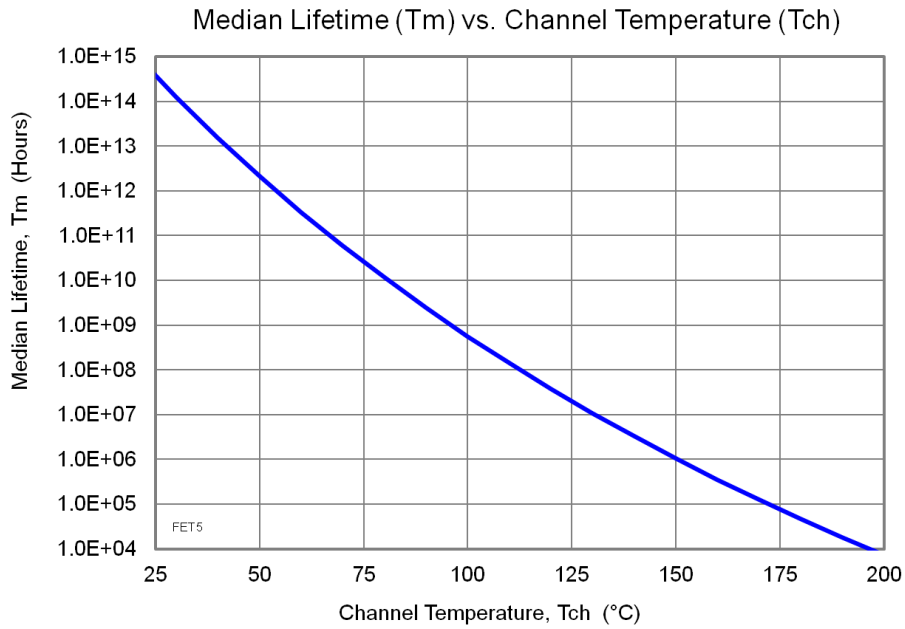

Performance Plots

Test conditions unless otherwise noted: VDLO1, VDLO23 = 3.3 V, VGLO = - 0.7 V, IDLO1+IDLO23 = 140 to 200 mA, VDRF = 5.0 V, VGRF = - 0.75 V, IDRf = 340 to 380 mA, VGX = - 1.2 V, 25 °C. Data taken with external IF hybrid and LO nulling applied

LSB Conversion Gain vs. RF vs. IF and LO Power
State: Max Gain

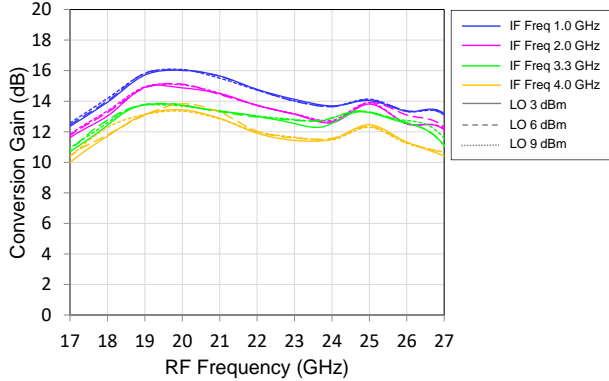

USB Conversion Gain vs. RF vs. IF and LO Power
State: Max Gain

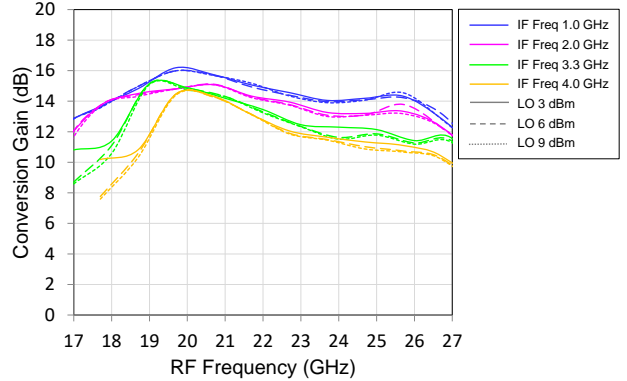

LSB Conversion Gain vs. RF vs. IF and LO Power
State: Reduced Gain

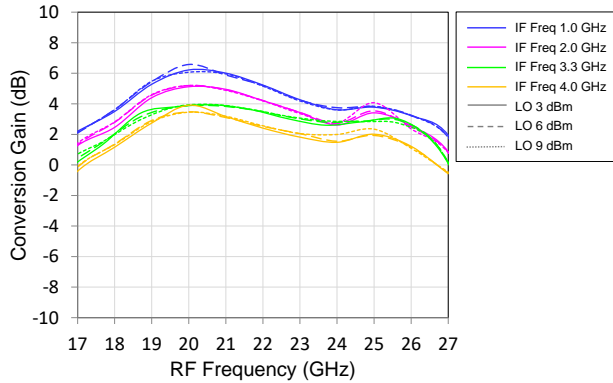

USB Conversion Gain vs. RF vs. IF and LO Power
State: Reduced Gain

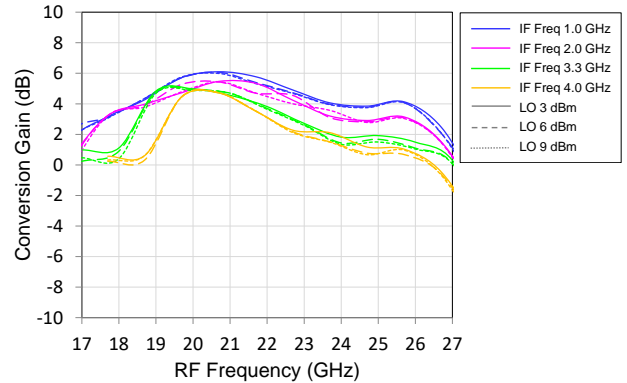

LSB Conversion Gain vs. RF vs. IF and LO Power
State: Min Gain

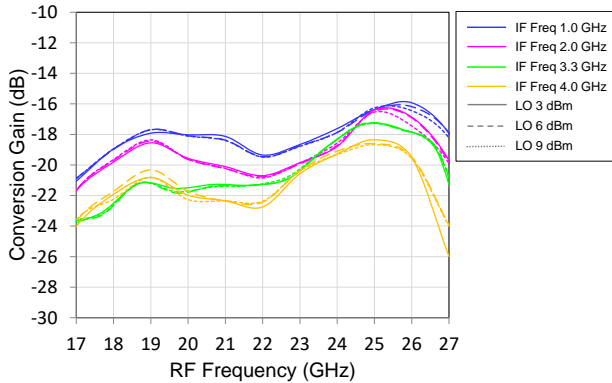

USB Conversion Gain vs. RF vs. IF and LO Power
State: Min Gain

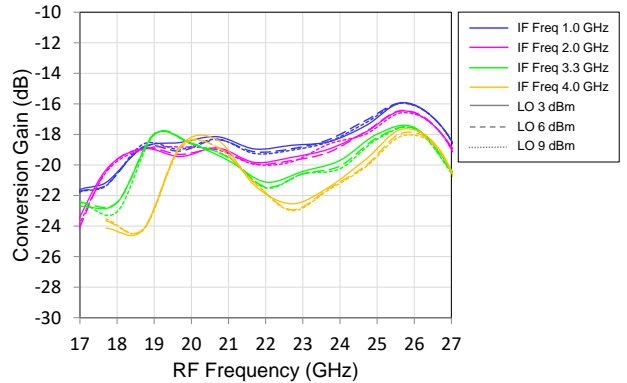

Performance Plots

Test conditions unless otherwise noted: VDLO1, VDLO23 = 3.3 V, VGLO = - 0.7 V, IDLO1+IDLO23 = 140 to 200 mA, VDRF = 5.0 V, VGRF = - 0.75 V, IDRf = 340 to 380 mA, VGX = - 1.2 V, 25 °C. Data taken with external IF hybrid and LO nulling applied.

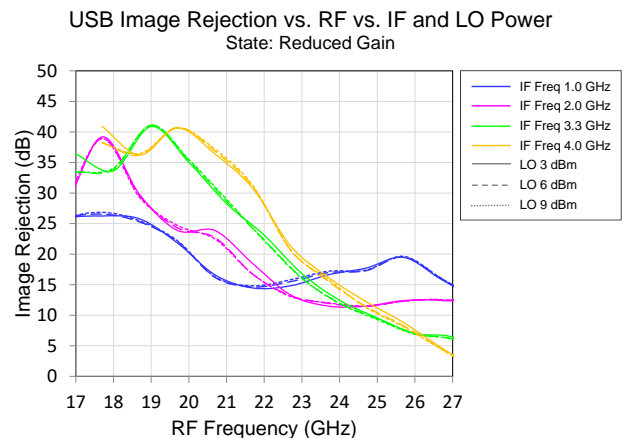
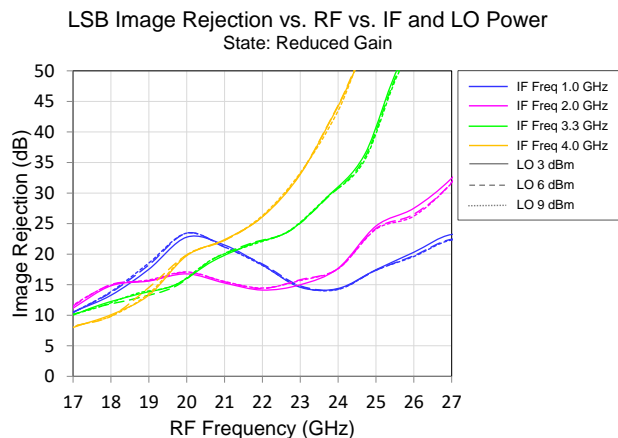
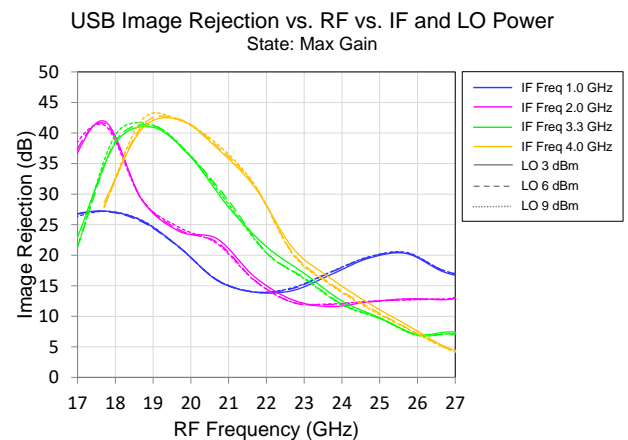
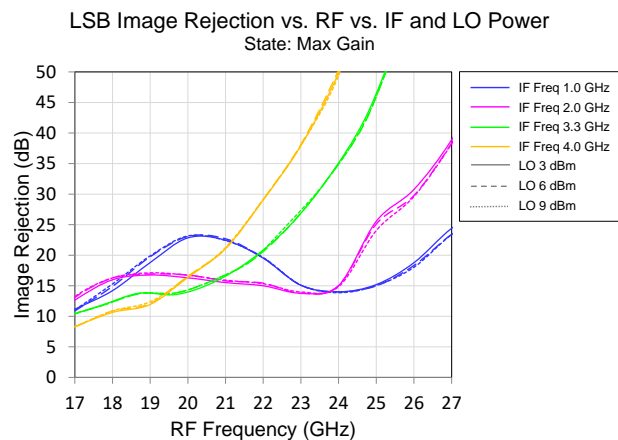
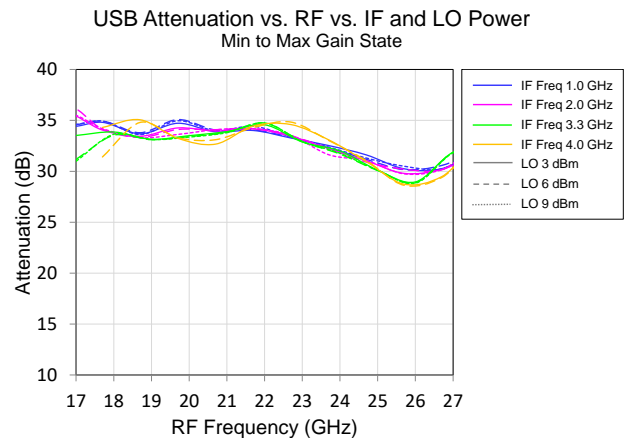
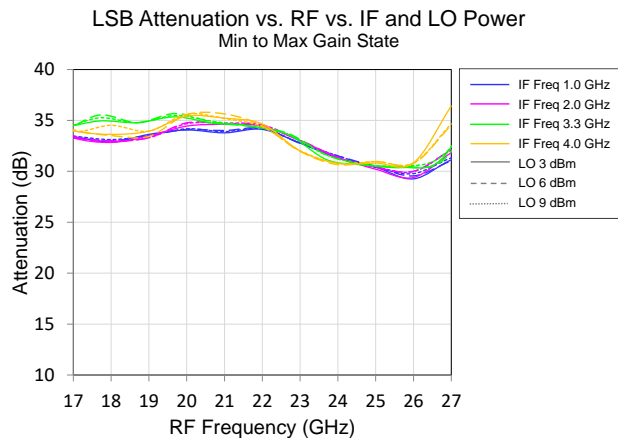

Performance Plots

Test conditions unless otherwise noted: VDLO1, VDLO23 = 3.3 V, VGLO = - 0.7 V, IDLO1+IDLO23 = 140 to 200 mA, VDRF = 5.0 V, VGRF = - 0.75 V, IDRf = 340 to 380 mA, VGX = - 1.2 V, 25 °C. Data taken with external IF hybrid and LO nulling applied.

LSB Image Rejection vs. RF vs. IF and LO Power
State: Min Gain

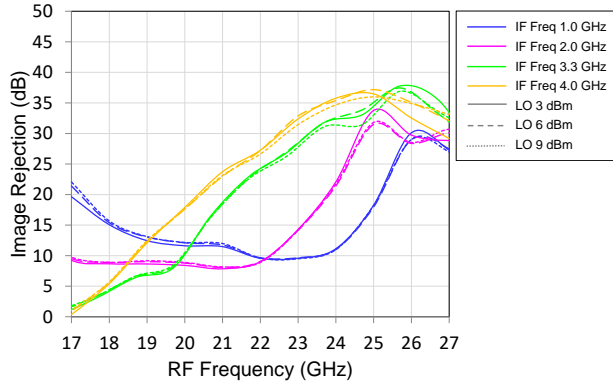

USB Image Rejection vs. RF vs. IF and LO Power
State: Min Gain

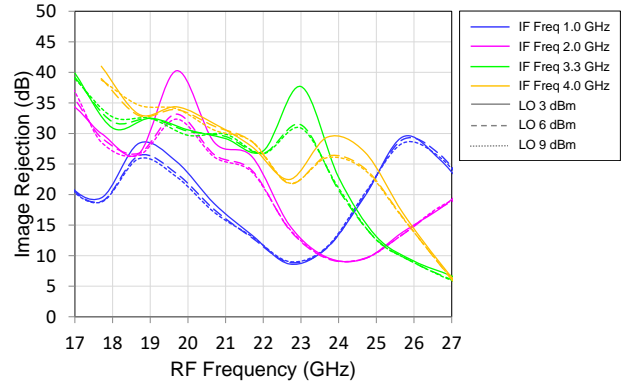

LSB Output P1dB vs. RF vs. IF and LO Power
State: Max Gain

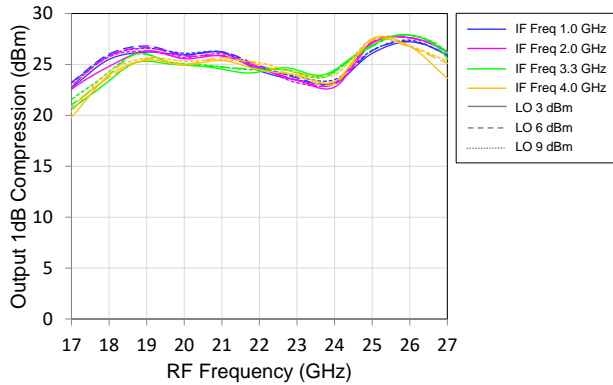

USB Output P1dB vs. RF vs. IF and LO Power
State: Max Gain

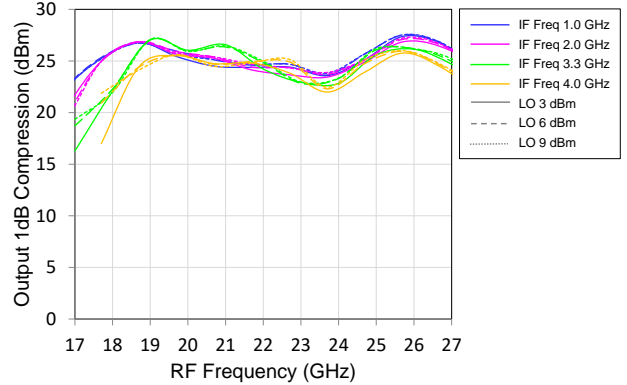

LSB Output IP3 vs. RF vs. IF and LO Power
State: Max Gain

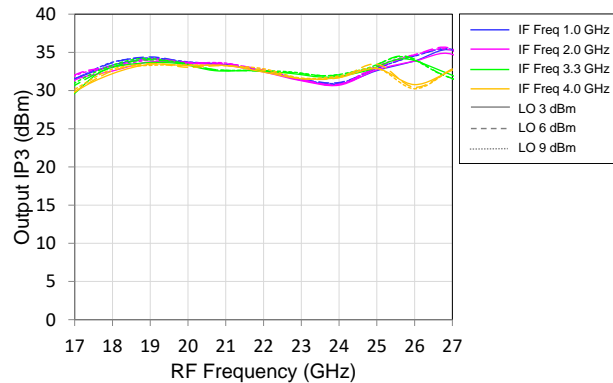

USB Output IP3 vs. RF vs. IF and LO Power
State: Max Gain

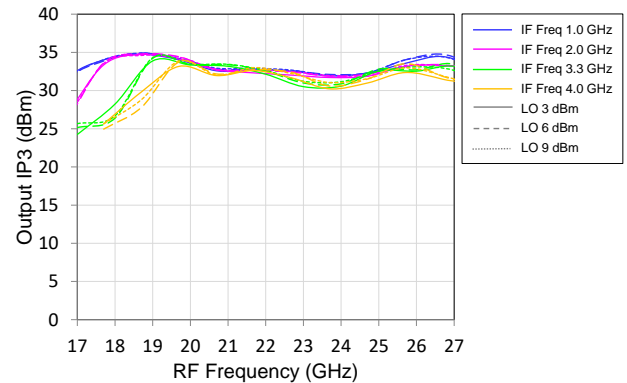

Performance Plots

Test conditions unless otherwise noted: VDLO1, VDLO23 = 3.3 V, VGLO = - 0.7 V, IDLO1+IDLO23 = 140 to 200 mA, VDRF = 5.0 V, VGRF = - 0.75 V, IDRf = 340 to 380 mA, VGX = - 1.2 V, 25 °C. Data taken with external IF hybrid and LO nulling applied.

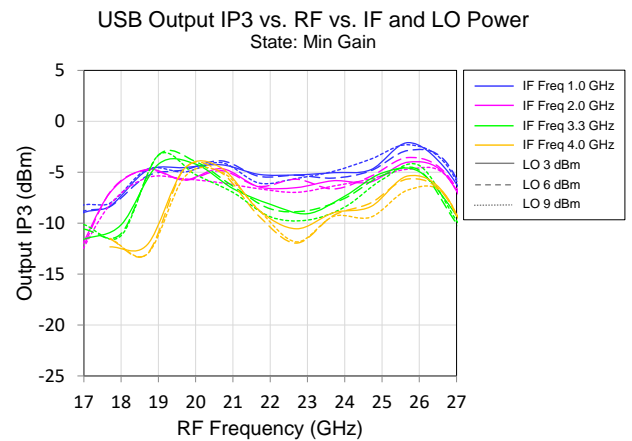
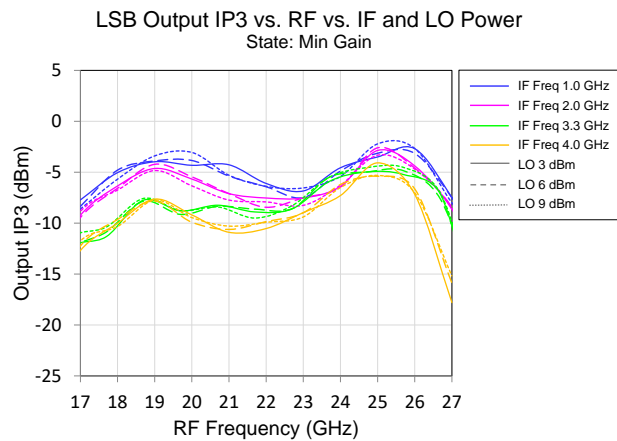
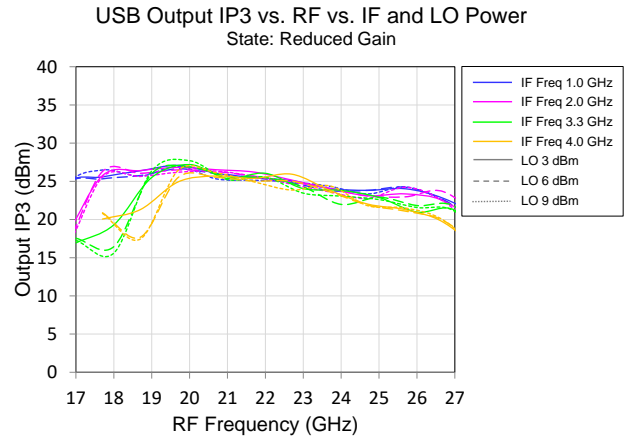
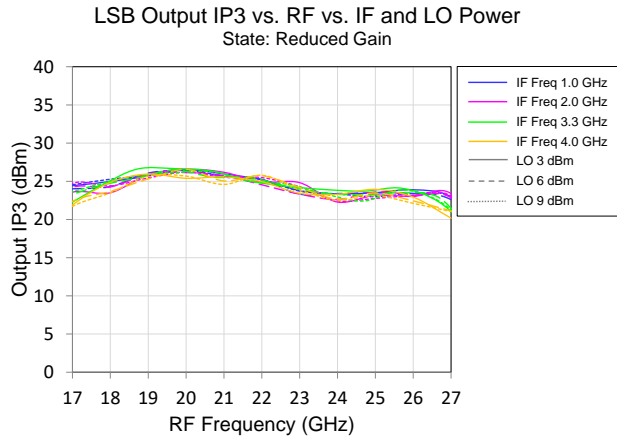

Performance Plots

Test conditions unless otherwise noted: VDLO1, VDLO23 = 3.3 V, VGLO = - 0.7 V, IDLO1+IDLO23 = 140 to 200 mA, VDRF = 5.0 V, VGRF = - 0.75 V, IDRf = 340 to 380 mA, VGX = - 1.2 V, 25 °C. Data taken with external IF hybrid and LO nulling applied.

LSB LO-to-RF Isolation vs. LO Freq vs. LO Power and State

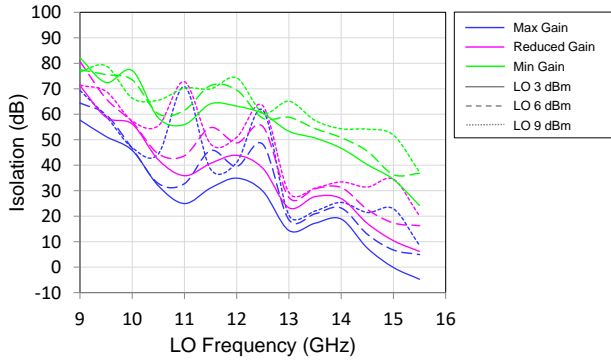

USB LO-to-RF Isolation vs. LO Freq vs. LO Power and State

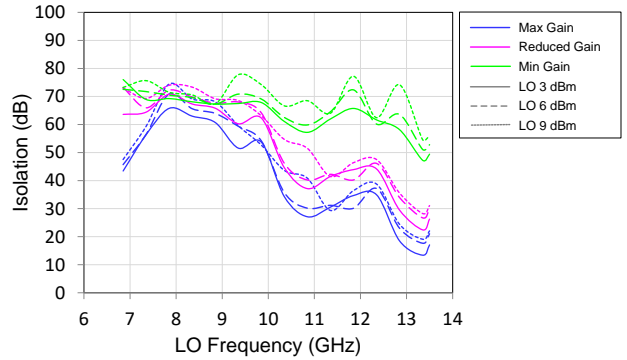

LSB LO-to-IF Isolation vs. LO Freq vs. LO Power and State

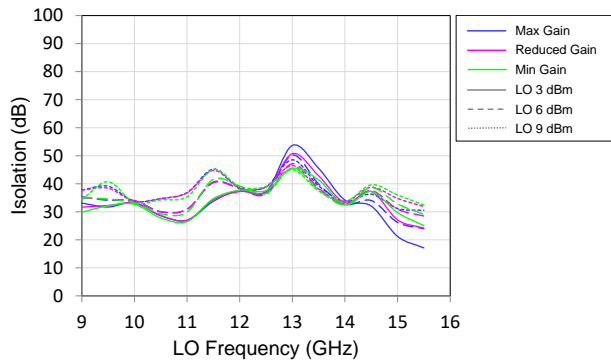

USB LO-to-IF Isolation vs. LO Freq vs. LO Power and State

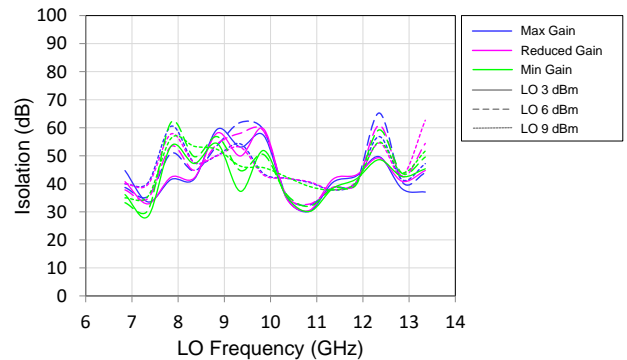

LSB IF-to-RF Isolation vs. LO Freq vs. IF and LO Power
State: Max Gain

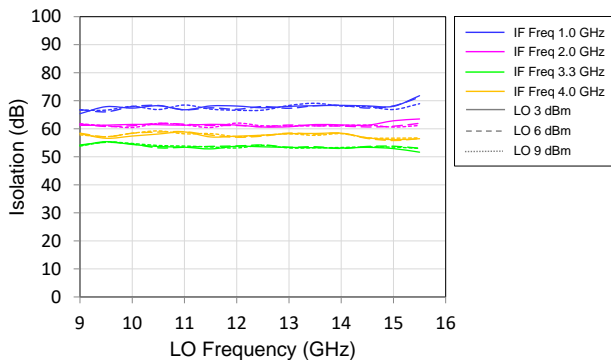

USB IF-to-RF Isolation vs. LO Freq vs. IF and LO Power
State: Max Gain

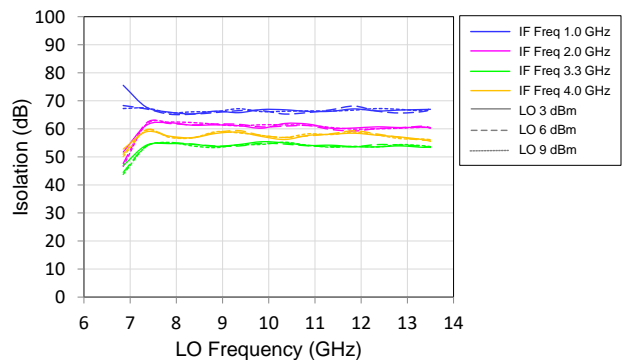

Performance Plots

Test conditions unless otherwise noted: VDLO1, VDLO23 = 3.3 V, VGLO = - 0.7 V, IDLO1+IDLO23 = 140 to 200 mA, VDRF = 5.0 V, VGRF = - 0.75 V, IDRf = 340 to 380 mA, VGX = - 1.2 V, 25 °C. Data taken with external IF hybrid and LO nulling applied.

LSB 2LO-to-RF Leakage vs. LO Freq vs. LO Power and State

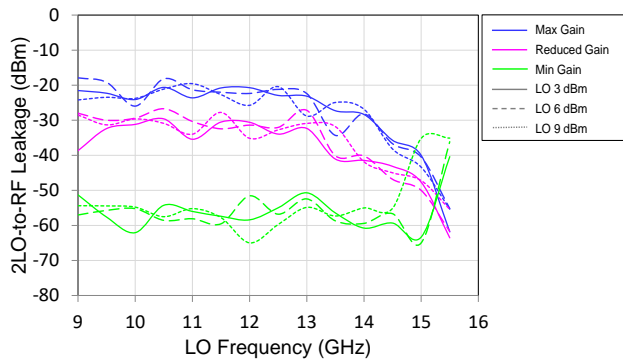

USB 2LO-to-RF Leakage vs. LO Freq vs. LO Power and State

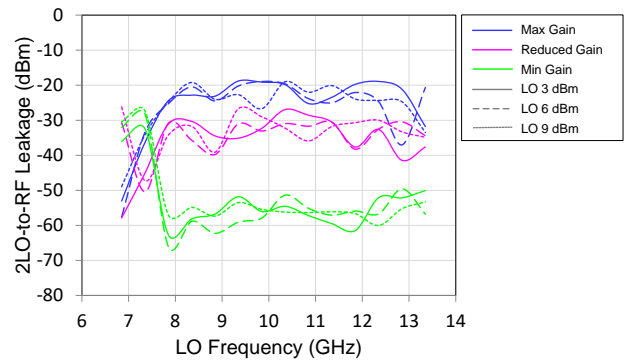

LSB 2LO-to-IF Leakage vs. LO Freq vs. LO Power and State

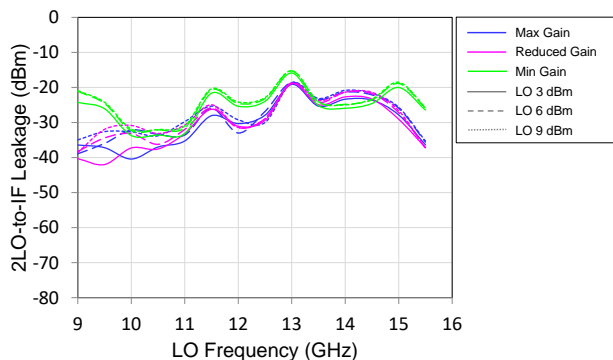

USB 2LO-to-IF Leakage vs. LO Freq vs. LO Power and State

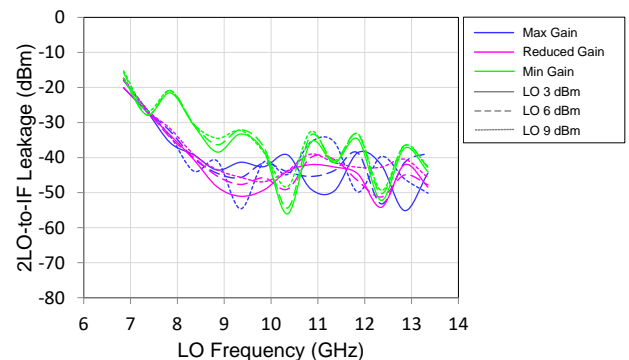

RF-to-IF Isolation vs. RF Freq vs. LO Power and State
IF1 port, without external IF Hybrid

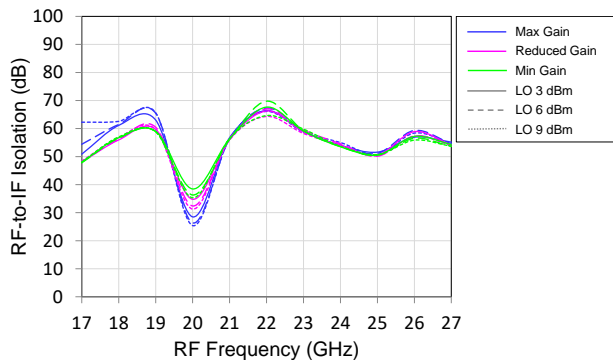

RF-to-IF Isolation vs. RF Freq vs. LO Power and State
IF2 port, without external IF Hybrid

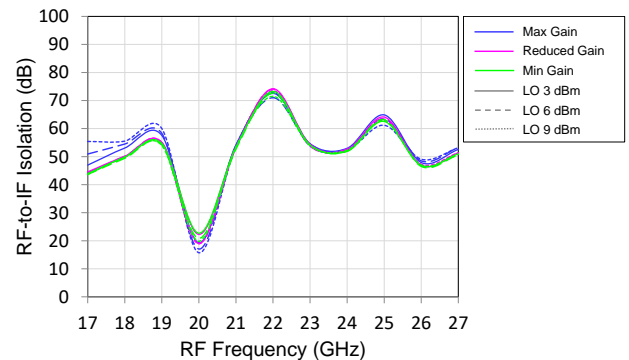

Performance Plots – Return Loss

Test conditions unless otherwise noted: VDLO1, VDLO23 = 3.3 V, VGLO = - 0.7 V, IDLO1+IDLO23 = 140 to 200 mA, VDRF = 5.0 V, VGRF = - 0.75 V, IDRF = 340 to 380 mA, VGX = - 1.2 V, 25 °C

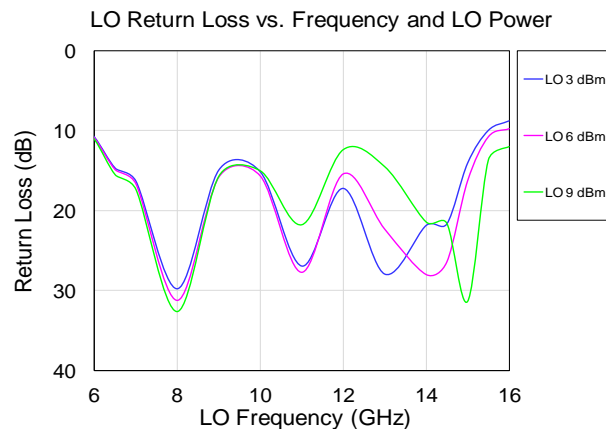
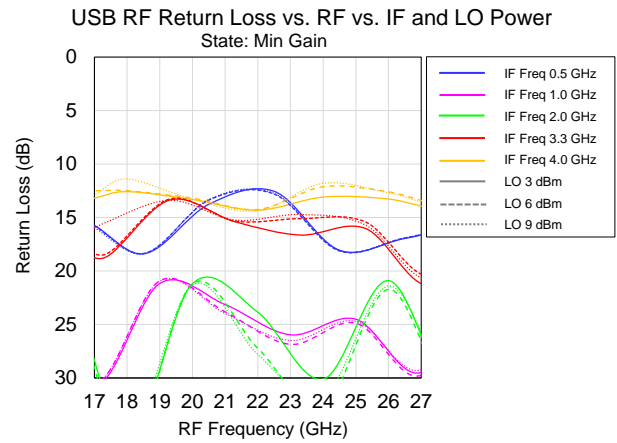
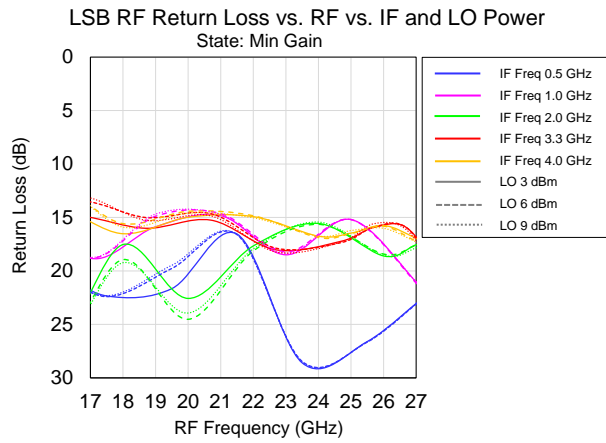
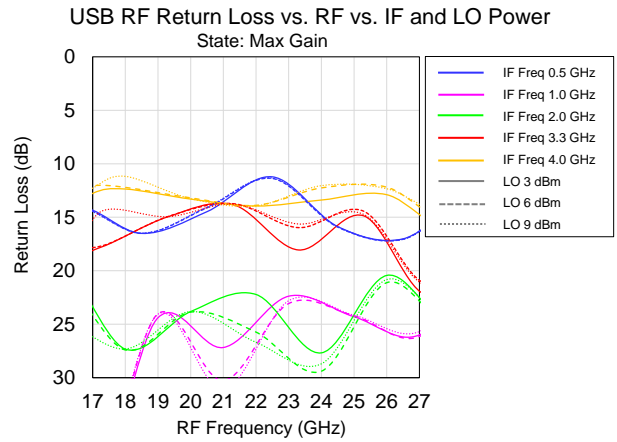
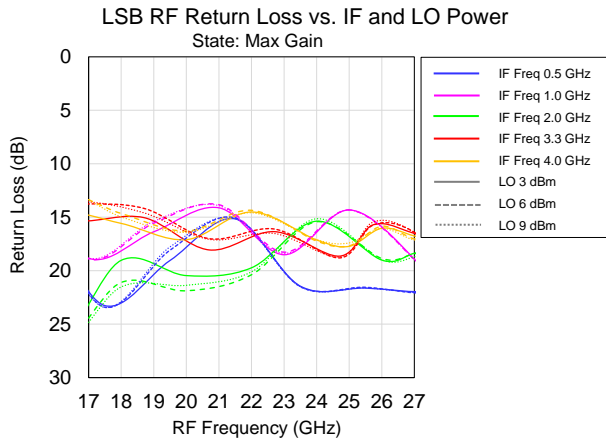

Performance Plots - External LO Nulling

Test conditions unless otherwise noted: VDLO1, VDLO23 = 3.3 V, VGLO = -0.7 V, IDLO1+IDLO23 = 140 to 200 mA, VDRF = 5.0 V, VGRF = -0.75 V, IDRf = 340 to 380 mA, VGX = -1.2 V, 25 °C.

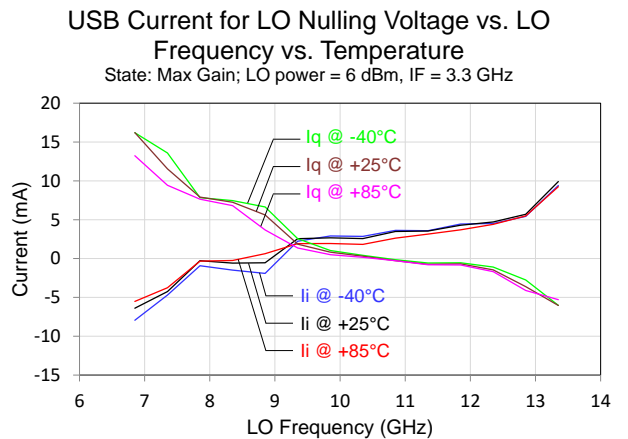
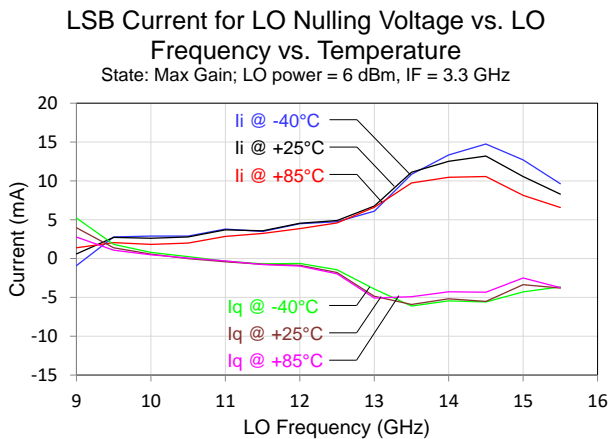
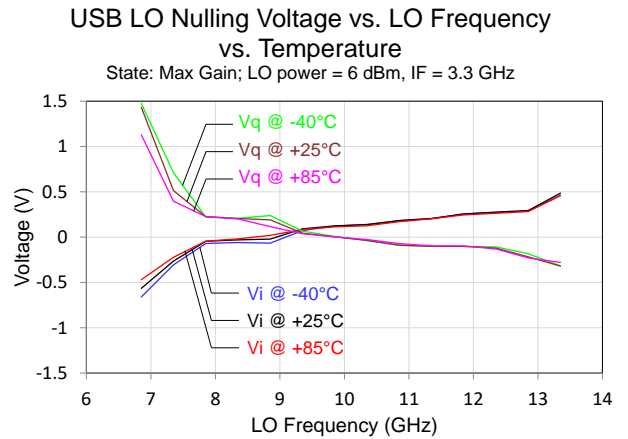
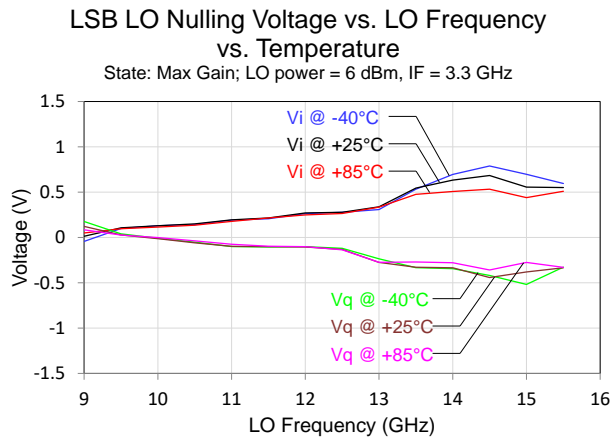
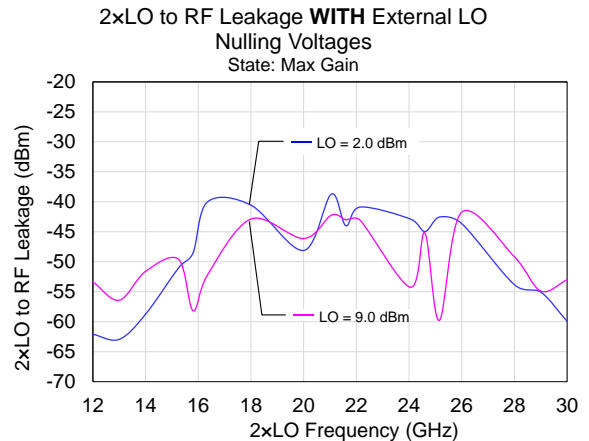
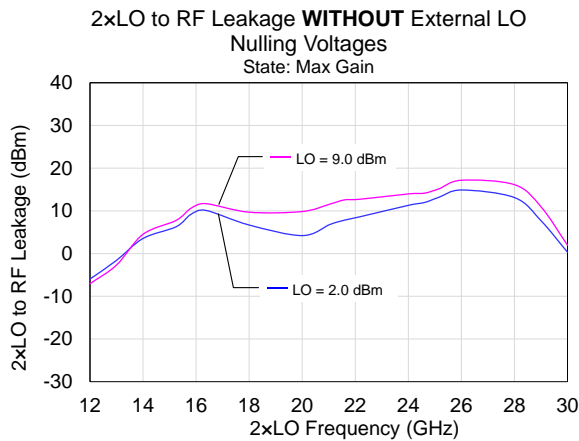

Performance Plots – Conversion Gain vs. Temperature

Test conditions unless otherwise noted: VDLO1, VDLO23 = 3.3 V, VGLO = - 0.7 V, IDLO1+IDLO23 = 140 to 200 mA, VD_{RF} = 5.0 V, VG_{RF} = - 0.75 V, I_{DRF} = 340 to 380 mA, VG_X = - 1.2 V, 25 °C. Data taken with external IF hybrid and LO nulling applied.

LSB Conversion Gain vs. RF Frequency vs. Temperature

State: Max Gain; LO power = 6 dBm, IF = 1 GHz

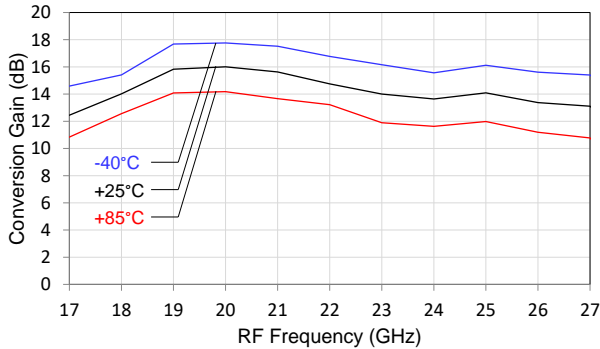

USB Conversion Gain vs. RF Frequency vs. Temperature

State: Max Gain; LO power = 6 dBm, IF = 1 GHz

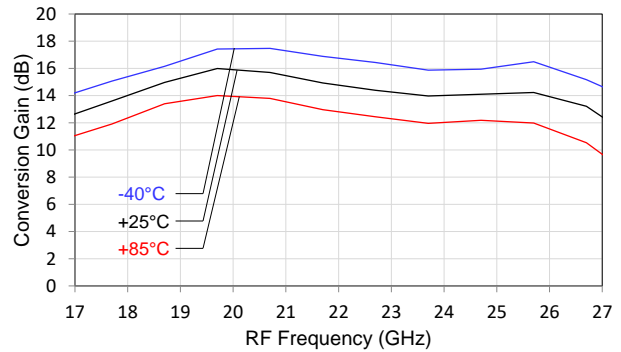

LSB Conversion Gain vs. RF Frequency vs. Temperature

State: Max Gain; LO power = 6 dBm, IF = 2 GHz

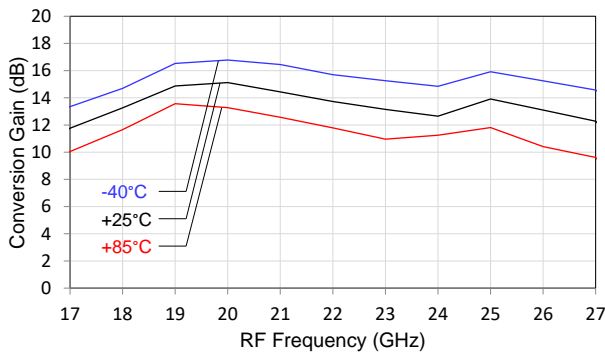

USB Conversion Gain vs. RF Frequency vs. Temperature

State: Max Gain; LO power = 6 dBm, IF = 2 GHz

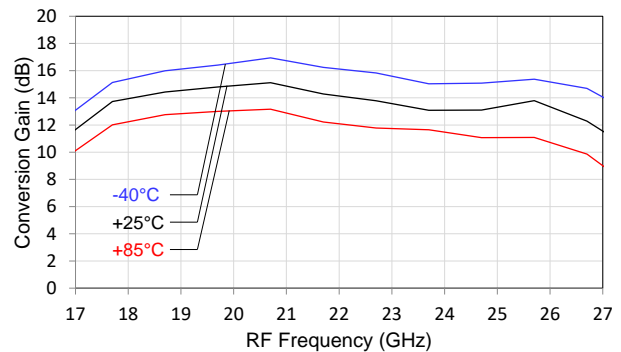

LSB Conversion Gain vs. RF Frequency vs. Temperature

State: Max Gain; LO power = 6 dBm, IF = 3.3 GHz

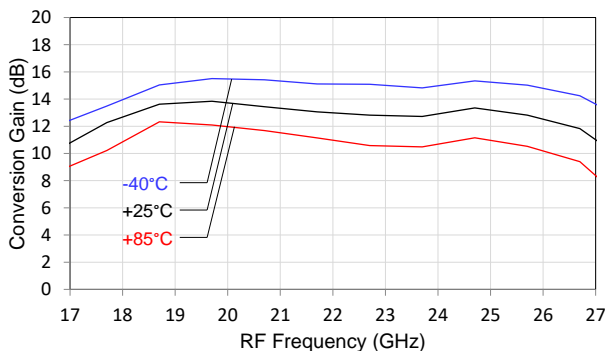

USB Conversion Gain vs. RF Frequency vs. Temperature

State: Max Gain; LO power = 6 dBm, IF = 3.3 GHz

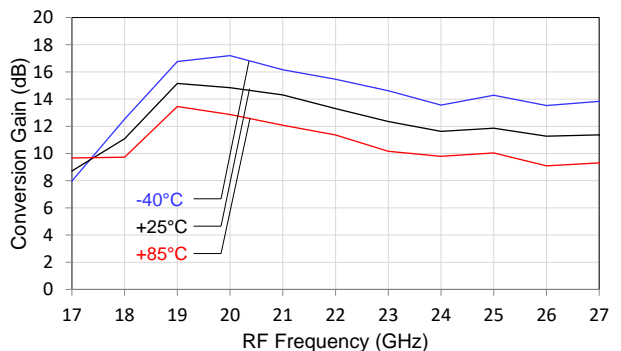

Performance Plots – Image Rejection vs. Temperature

Test conditions unless otherwise noted: VDLO1, VDLO23 = 3.3 V, VGLO = - 0.7 V, IDLO1+IDLO23 = 140 to 200 mA, VDRF = 5.0 V, VGRF = - 0.75 V, IDRf = 340 to 380 mA, VGX = - 1.2 V, 25 °C. Data taken with external IF hybrid and LO nulling applied

LSB Image Rejection vs. RF Frequency vs. Temperature

State: Max Gain; LO power = 6 dBm, IF = 1 GHz

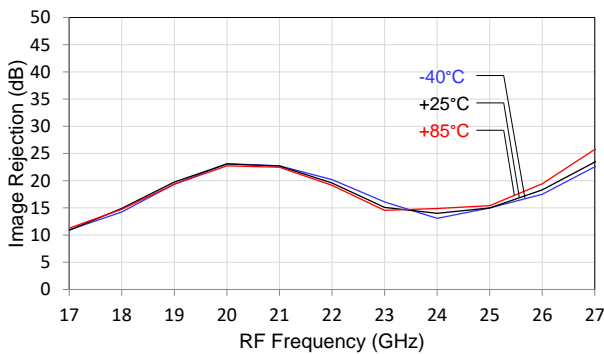

USB Image Rejection vs. RF Frequency vs. Temperature

State: Max Gain; LO power = 6 dBm, IF = 1 GHz

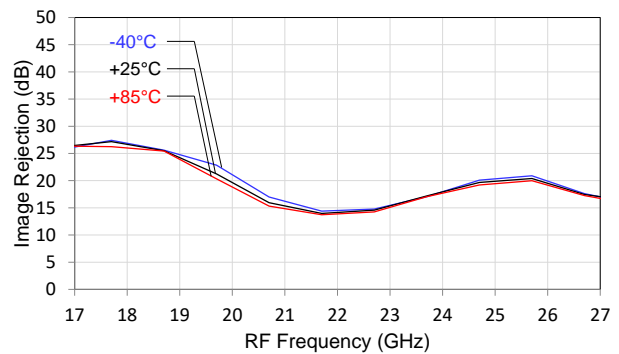

LSB Image Rejection vs. RF Frequency vs. Temperature

State: Max Gain; LO power = 6 dBm, IF = 2 GHz

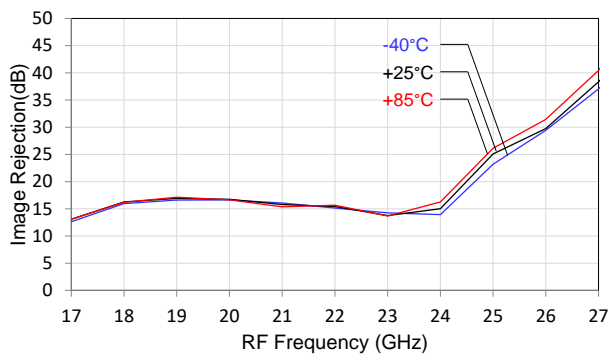

USB Image Rejection vs. RF Frequency vs. Temperature

State: Max Gain; LO power = 6 dBm, IF = 2 GHz

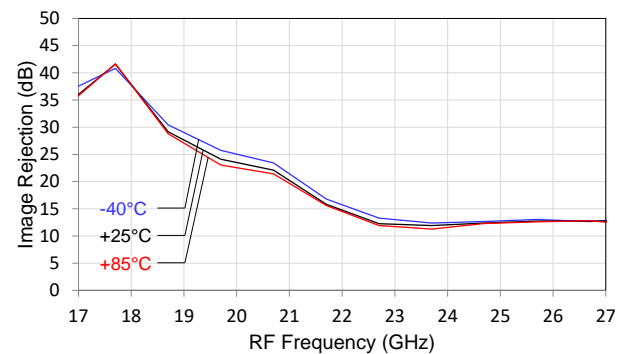

LSB Image Rejection vs. RF Frequency vs. Temperature

State: Max Gain; LO power = 6 dBm, IF = 3.3 GHz

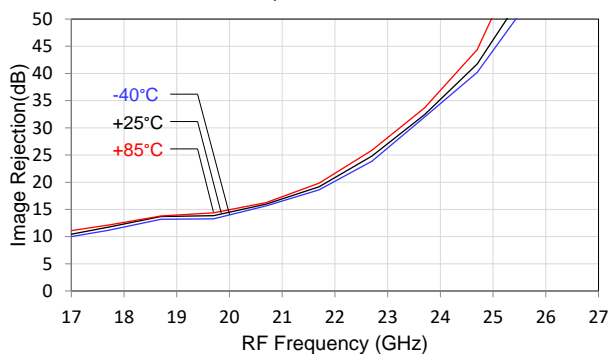

USB Image Rejection vs. RF Frequency vs. Temperature

State: Max Gain; LO power = 6 dBm, IF = 3.3 GHz

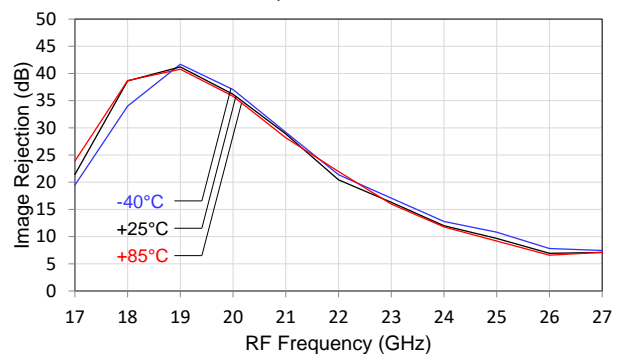

Performance Plots – 1dB Compression vs. Temperature

Test conditions unless otherwise noted: VDLO1, VDLO23 = 3.3 V, VGLO = - 0.7 V, IDLO1+IDLO23 = 140 to 200 mA, VDRF = 5.0 V, VGRF = - 0.75 V, IDRF = 340 to 380 mA, VGX = - 1.2 V, 25 °C. Data taken with external IF hybrid and LO nulling applied.

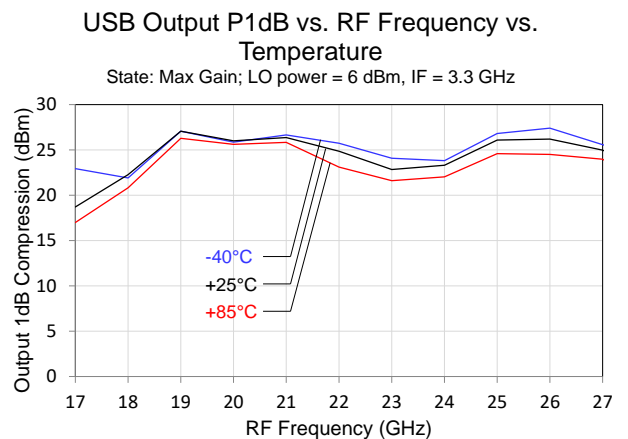
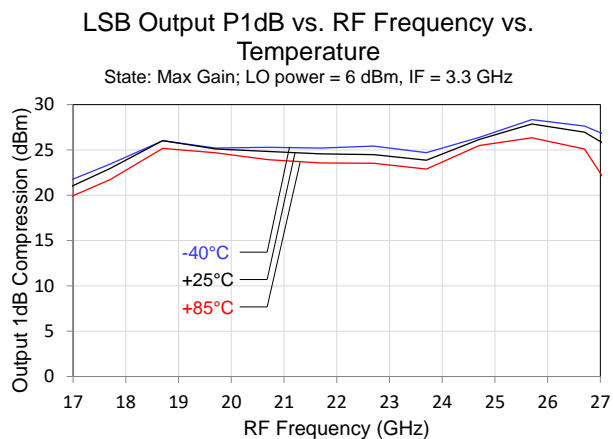
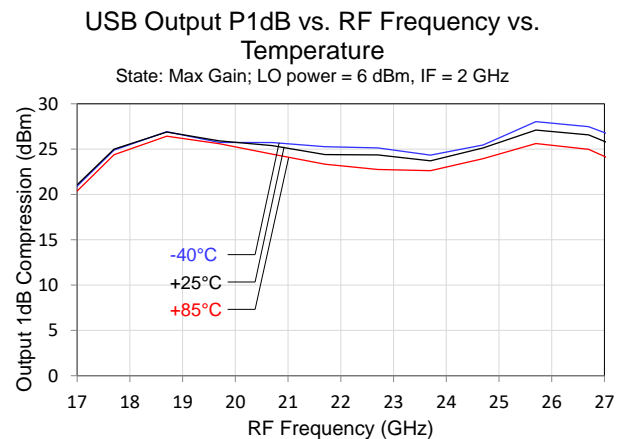
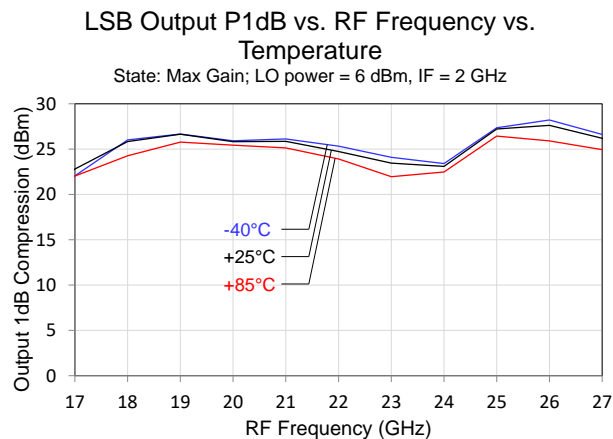
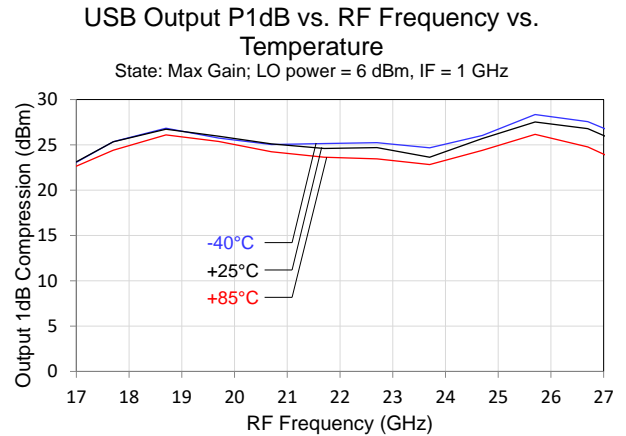
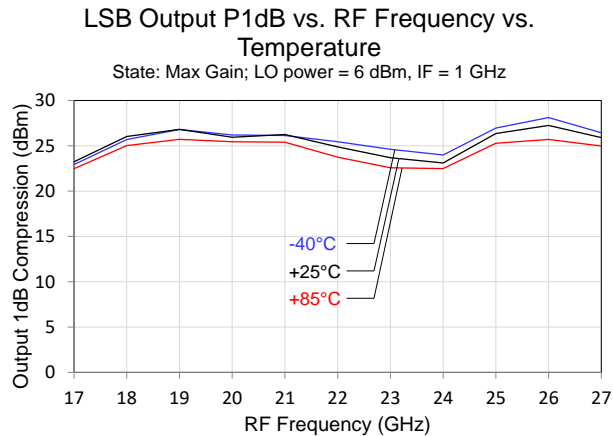

Performance Plots – Output IP3 vs. Temperature

Test conditions unless otherwise noted: VDLO1, VDLO23 = 3.3 V, VGLO = - 0.5 V, IDLO1+IDLO23 = 140 to 200 mA, VDRF = 5.0 V, VGRF = - 0.75 V, IDRF = 340 to 380 mA, VGX = - 1.2 V, 25 °C. Data taken with external IF hybrid and LO nulling applied.

LSB Output IP3 vs. RF Frequency vs. Temperature

State: Max Gain; LO power = 6 dBm, IF = 1 GHz

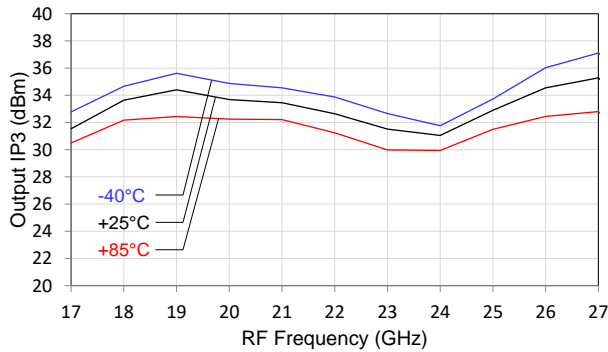

USB Output IP3 vs. RF Frequency vs. Temperature

State: Max Gain; LO power = 6 dBm, IF = 1 GHz

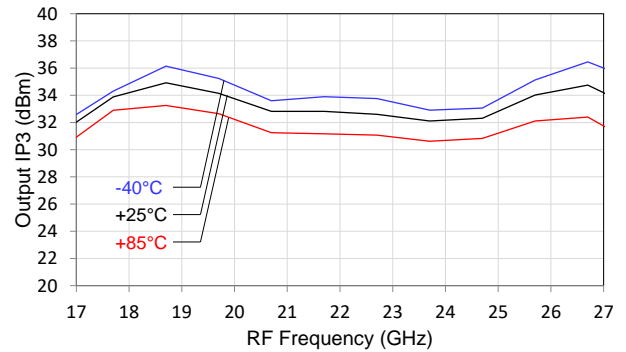

LSB Output IP3 vs. RF Frequency vs. Temperature

State: Max Gain; LO power = 6 dBm, IF = 2 GHz

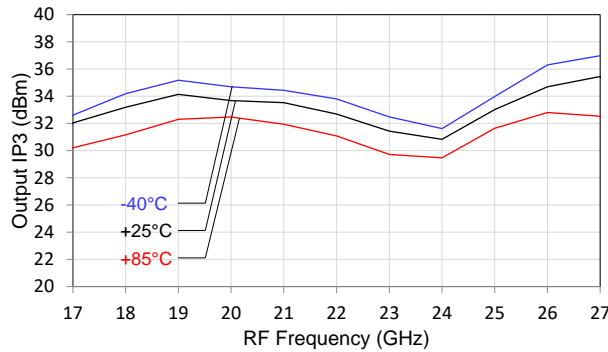

USB Output IP3 vs. RF Frequency vs. Temperature

State: Max Gain; LO power = 6 dBm, IF = 2 GHz

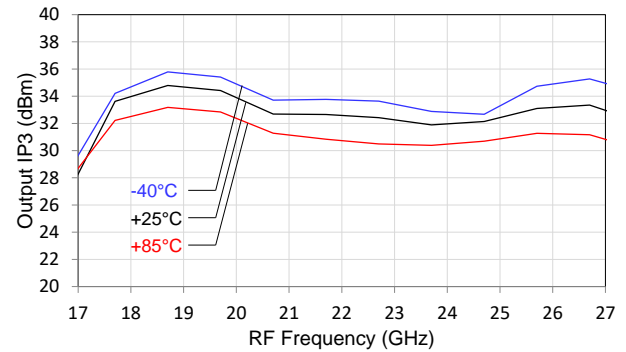

LSB Output IP3 vs. RF Frequency vs. Temperature

State: Max Gain; LO power = 6 dBm, IF = 3.3 GHz

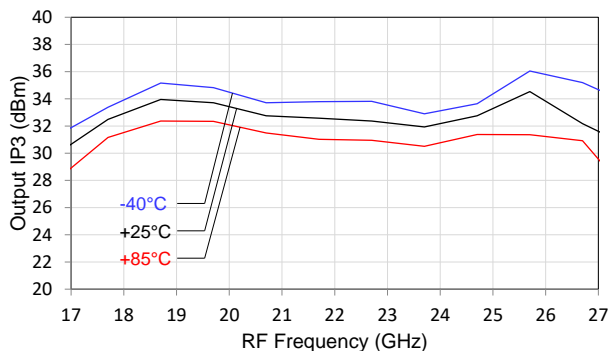

USB Output IP3 vs. RF Frequency vs. Temperature

State: Max Gain; LO power = 6 dBm, IF = 3.3 GHz

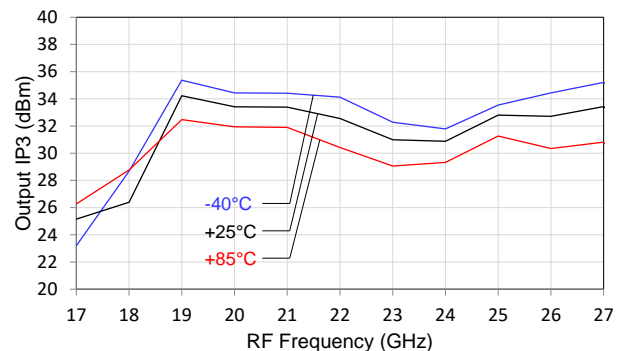

Mixing Products

Test conditions unless otherwise noted: VDLO1, VDLO23 = 3.3 V, VGLO = - 0.7 V, IDLO1+IDLO23 = 140 to 200 mA, VDRF = 5.0 V, VGRF = - 0.75 V, IDRF = 340 to 380 mA, VGX = - 1.2 V, 25 °C. Data taken with external IF hybrid and LO nulling applied, 25 °C.

M x N Spurious Outputs for LSB

Spur tables are $N \times f_{IF} - M \times f_{LO}$ mixer spurious products. RF frequency is at $2 \times LO - IF$.

All values are in dBc below the RF output power level. IF input power = -10 dBm, LO Power = 3 to 9 dBm.

| | | M x f _{LO} | | | | | |
|---------------------|----|---------------------|----|----|----|----|----|
| | | 0 | 1 | 2 | 3 | 4 | 5 |
| N x f _{IF} | -5 | -- | 86 | 79 | 70 | 60 | 63 |
| | -4 | -- | 85 | 76 | 74 | 63 | 61 |
| | -3 | -- | 84 | 77 | 70 | 59 | 60 |
| | -2 | -- | 82 | 74 | 66 | 64 | 61 |
| | -1 | -- | 81 | 0 | 63 | 58 | 61 |
| | 0 | -- | 12 | 19 | 4 | 33 | 53 |
| | 1 | 89 | 75 | 12 | 63 | 57 | 60 |
| | 2 | 83 | 75 | 73 | 61 | 61 | 57 |
| | 3 | 82 | 74 | 67 | 60 | 60 | -- |
| | 4 | 79 | 76 | 69 | 63 | 60 | -- |
| 5 | 84 | 77 | 67 | 59 | 58 | -- | |

If = 2.0 GHz, LO = 9.0 GHz to 13.0 GHz

| | | M x f _{LO} | | | | | |
|---------------------|----|---------------------|----|----|----|----|----|
| | | 0 | 1 | 2 | 3 | 4 | 5 |
| N x f _{IF} | -5 | -- | 84 | 80 | 73 | 64 | 62 |
| | -4 | -- | 86 | 79 | 68 | 61 | 64 |
| | -3 | -- | 87 | 78 | 70 | 64 | 61 |
| | -2 | -- | 83 | 71 | 63 | 61 | 66 |
| | -1 | -- | 49 | 0 | 38 | 63 | 65 |
| | 0 | -- | -3 | 20 | 27 | 37 | 53 |
| | 1 | 75 | 37 | 11 | 61 | 62 | -- |
| | 2 | 84 | 77 | 64 | 63 | 63 | -- |
| | 3 | 83 | 75 | 62 | 60 | 58 | -- |
| | 4 | 79 | 74 | 59 | 60 | -- | -- |
| 5 | 76 | 69 | 62 | 64 | -- | -- | |

IF = 3.3 GHz, LO = 10.0 GHz to 15.0 GHz

M x N Spurious Outputs for USB

Spur tables are $N \times f_{IF} - M \times f_{LO}$ mixer spurious products. RF frequency is at $2 \times LO + IF$.

All values are in dBc below the RF output power level. IF input power = -10 dBm, LO Power = 3 to 9 dBm.

| | | M x f _{LO} | | | | | |
|---------------------|----|---------------------|----|-----|----|----|----|
| | | 0 | 1 | 2 | 3 | 4 | 5 |
| N x f _{IF} | -5 | -- | 89 | 77 | 76 | 65 | 62 |
| | -4 | -- | 88 | 76 | 78 | 65 | 62 |
| | -3 | -- | 88 | 79 | 73 | 64 | 64 |
| | -2 | -- | 84 | 68 | 72 | 61 | 62 |
| | -1 | -- | 76 | 14 | 53 | 54 | 65 |
| | 0 | -- | 26 | -13 | 6 | 32 | 55 |
| | 1 | 69 | 59 | 0 | 42 | 61 | 63 |
| | 2 | 88 | 77 | 66 | 61 | 63 | 64 |
| | 3 | 85 | 79 | 74 | 64 | 59 | 66 |
| | 4 | 85 | 79 | 71 | 66 | 65 | 65 |
| 5 | 85 | 79 | 69 | 62 | 63 | 61 | |

If = 2.0 GHz, LO = 8.0 GHz to 12.0 GHz

| | | M x f _{LO} | | | | | |
|---------------------|----|---------------------|----|-----|----|-----|----|
| | | 0 | 1 | 2 | 3 | 4 | 5 |
| N x f _{IF} | -5 | -- | 84 | 87 | 77 | 74 | 61 |
| | -4 | -- | 85 | 82 | 77 | 74 | 66 |
| | -3 | -- | 88 | 79 | 79 | 69 | 63 |
| | -2 | -- | 86 | 72 | 74 | 55 | 63 |
| | -1 | -- | 78 | 10 | 43 | 21 | 51 |
| | 0 | -- | 25 | -14 | 1 | -24 | 49 |
| | 1 | 59 | 52 | 0 | 35 | 33 | 63 |
| | 2 | 86 | 77 | 60 | 64 | 63 | 62 |
| | 3 | 85 | 78 | 69 | 63 | 61 | 62 |
| | 4 | 80 | 78 | 68 | 61 | 61 | 61 |
| 5 | 77 | 71 | 62 | 60 | 63 | 60 | |

IF = 3.3 GHz, LO = 11.0 GHz to 15.5 GHz

Pin Configuration and Description

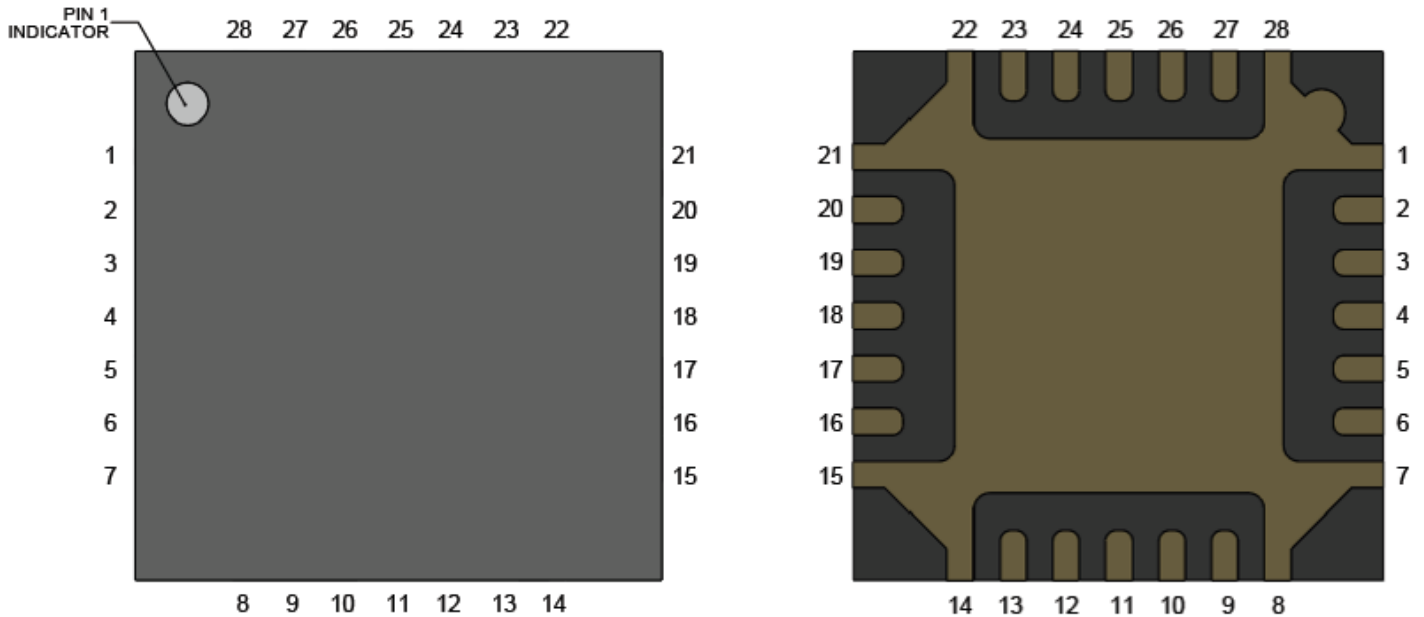

| Pin No. | Label | Description |
|--|--------|---|
| 1, 7, 8, 9, 13, 14, 15, 21, 22, 27, 28 | GND | Internal grounding; must be grounded on PCB. |
| 2 | RF OUT | RF Output matched to 50 ohms, AC Coupled. |
| 3, 11, 19, 20, 24 | NC | No internal connection; must be grounded on PCB. |
| 4 | VCTRL2 | Variable gain control for RF amplifier |
| 5 | VCTRL1 | Variable gain control for RF amplifier |
| 6 | VGRF | Gate voltage for RF amplifier |
| 10 | IF2 | IF input for upconverter |
| 12 | IF1 | IF input for upconverter |
| 16 | LO IN | LO input for upconverter. |
| 17 | VDLO1 | Drain voltage for the first stage of the LO doubler |
| 18 | VGLO | Gate bias for VDLO1 and VDLO23. |
| 23 | VDLO23 | Drain voltage for stages 2 and 3 of LO doubler |
| 25 | VGX | Mixer bias voltage |
| 26 | VDRF | Drain voltage for the RF amplifier |
| 29 | GND | Backside Paddle |

Evaluation Board (EVB) Assembly Layout

Board material is single core layer using 0.008" thick Rogers RO4003, $\epsilon_r = 3.38$. Metal layer is 0.5-oz copper cladding.

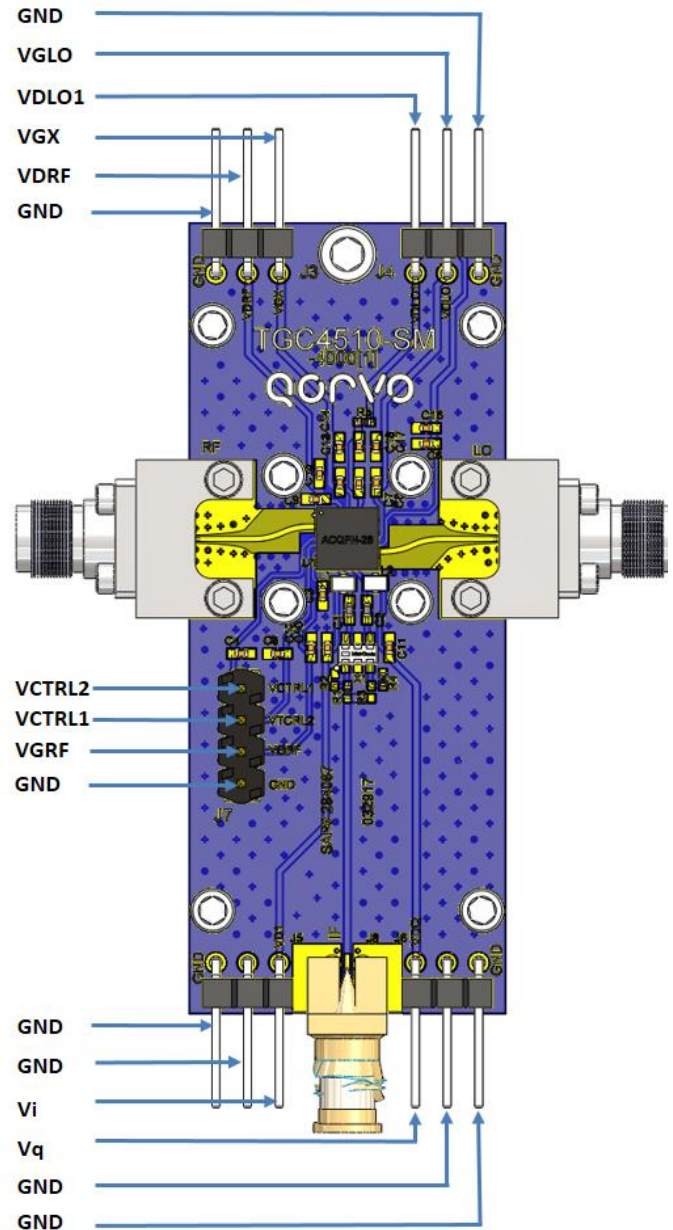
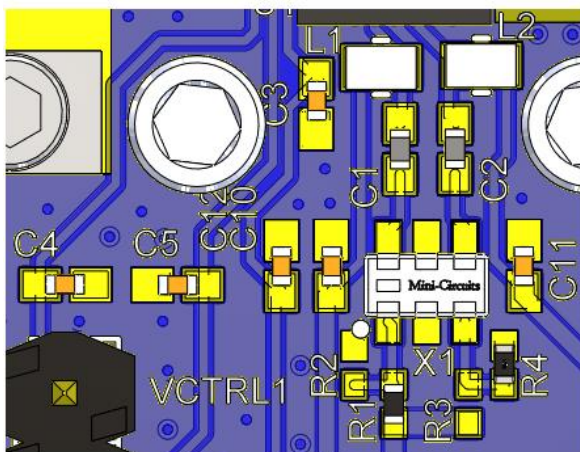
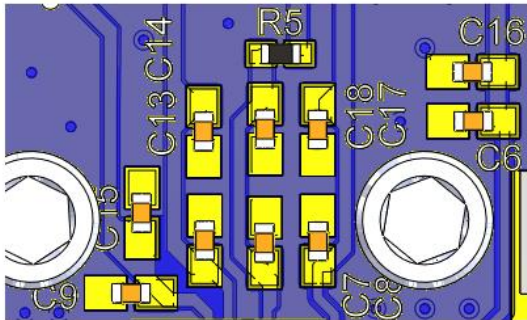

Applications Circuit

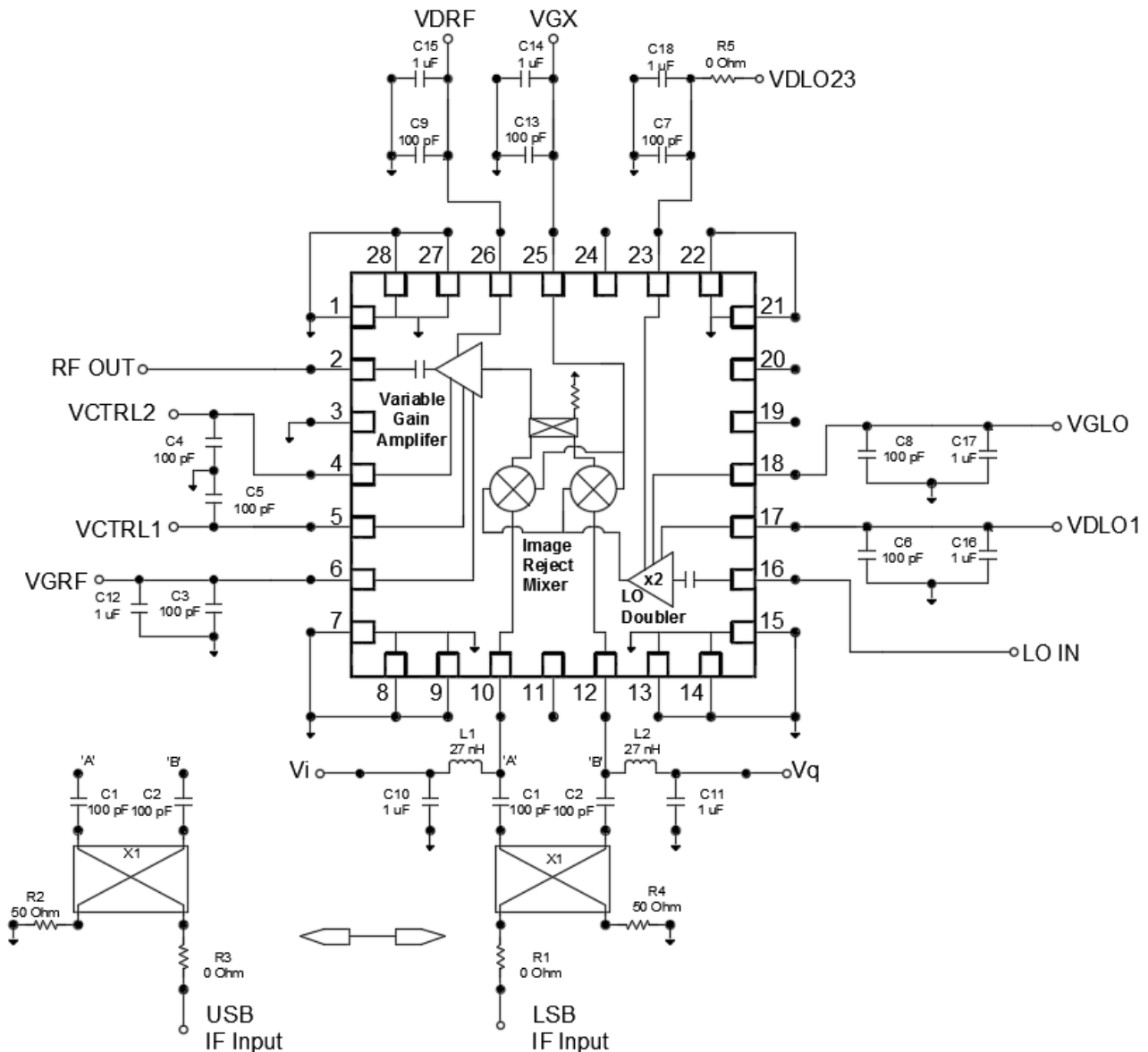

Bias-up Procedure

Set VGX = -1.2 V, VCTRL1 = -2.0 V, VCTRL2 = 0 V, VGLO = -1.2 V, VGRF = -1.2 V. Set limit for each to 10mA.

Set VDRF = 5.0 V, limit 390 mA, VDLO1 and VDLO23 = 3.3 V. Set VDLO1 limit to 150 mA and VDLO23 limit to 200 mA or VDLO1+VDLO23 = 350 mA

Adjust VGLO to get IDLO1+IDLO23 to 180 mA.

Adjust VGRF to get RF amplifier current (VDRF) of 360 mA.

Apply LO and IF signals.

If using external control for LO nulling, adjust Vi and Vq for optimum LO suppression, adjust VCTRL1 and VCTRL2 to get required conversion gain.

Bias-down Procedure

Turn off IF and LO signals.

Set VDLO1, VDLO23 to 0 V.

Set VDRF to 0 V.

Set Vi, Vq to 0 V if used LO nulling.

Set VGLO, VGRF, VGX to 0 V.

Set VCTRL1, VCTRL2 to 0 V.

Application Circuit Components

Bill of Material

| Ref Des | Value | Description | Manufacturer | Part Number |
|----------------------|------------|------------------------------|--------------|-------------|
| C1 – C9, C13 | 100 pF | Cap, 0603, 25 V, +/- 5%, NPO | various | |
| C10 – C12, C14 – C18 | 1 μ F | Cap, 0603, 25 V, 10%, X7R | various | |
| L1 – L2 | 27 nH | Ind, 0603, 2%, 0.6A, SMD | various | |
| R5 | 0 Ω | Res, 0402, 1/10 W, 5%, SMD | various | |
| Q1 | | Ku-Band Up-Converter | QORVO | TGC4510-SM |

LSB Configuration

| Ref Des | Value | Description | Manufacturer | Part Number |
|------------------|-------------|-----------------------------------|---------------|-------------|
| X1 (For Low IF) | | IF Quad Coupler, 1.35 to 2.45 GHz | Mini-Circuits | QCN-25+ |
| X1 (For High IF) | | IF Quad Coupler, 2.5 to 4.0 GHz | Mini-Circuits | QCN-45+ |
| R1 | 0 Ω | Res, 0402, 1/10 W, 5%, SMD | various | |
| R4 | 50 Ω | Res, 0402, 1/8 W, 1%, SMD | various | |
| R2, R3 | | DNP | | |

USB Configuration

| Ref Des | Value | Description | Manufacturer | Part Number |
|------------------|-------------|-----------------------------------|---------------|-------------|
| X1 (For Low IF) | | IF Quad Coupler, 1.35 to 2.45 GHz | Mini-Circuits | QCN-25+ |
| X1 (For High IF) | | IF Quad Coupler, 2.5 to 4.0 GHz | Mini-Circuits | QCN-45+ |
| R3 | 0 Ω | Res, 0402, 1/10 W, 5%, SMD | various | |
| R2 | 50 Ω | Res, 0402, 1/8 W, 1%, SMD | various | |
| R1, R4 | | DNP | | |

Note: Due to bandwidth limitations of IF quad coupler, two versions of coupler were used on EVBs, users need to choose low or high band of IF to be used, in addition to LSB and USB selection. Refer to ordering information section for details.

Package Marking and Dimensions

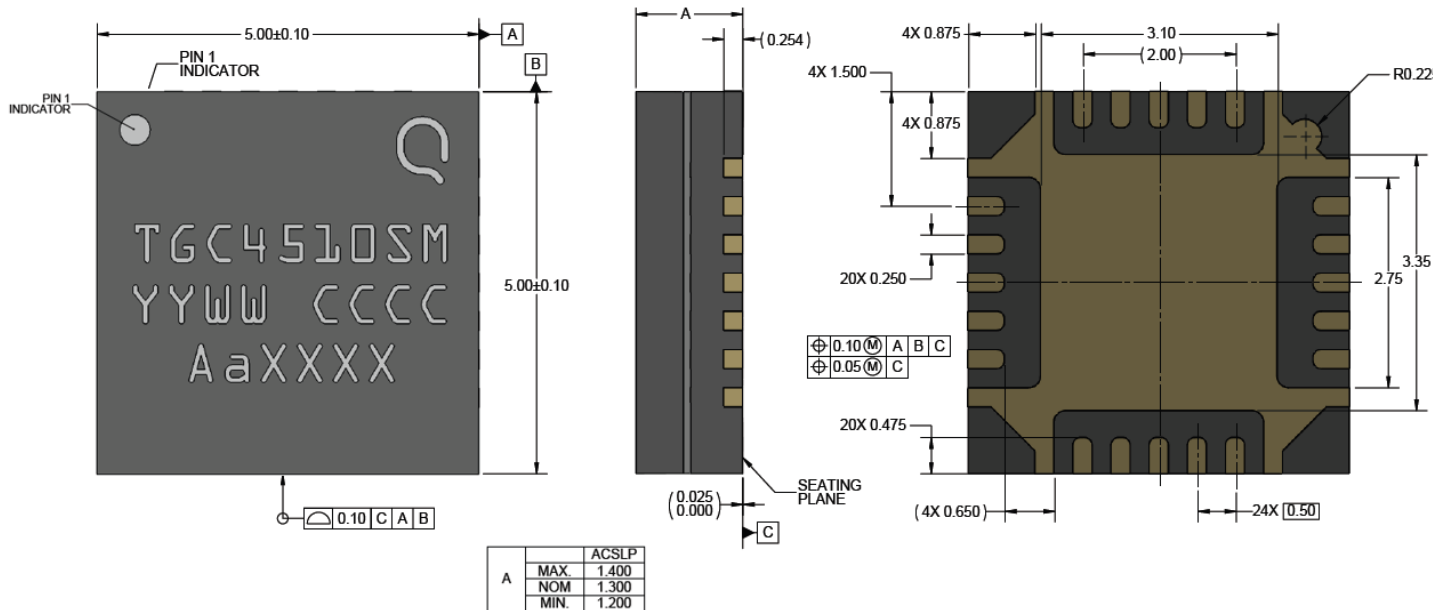

All dimensions are in millimeters. Top marking: “YY” represents the last two digits of the year the part was manufactured, the “WW” is the work week, CCCC is country code and the “XXXX” is batch ID.

This package is lead-free/RoHS-compliant with a copper alloy base (CDA194), and the plating material on the leads is NiPdAu. It is compatible with a lead-free (maximum 260 °C reflow temperature) soldering process.

PCB Mounting Pattern

Notes:

1. The pad pattern shown has been developed and tested for optimized assembly at Qorvo. The PCB land pattern has been developed to accommodate lead and package tolerances. Since surface mount processes vary from company to company, careful process development is recommended.
2. Ground / thermal vias are critical for the proper performance of this device. Vias should use a .35mm diameter drill and have a final plated thru diameter of .25 mm.

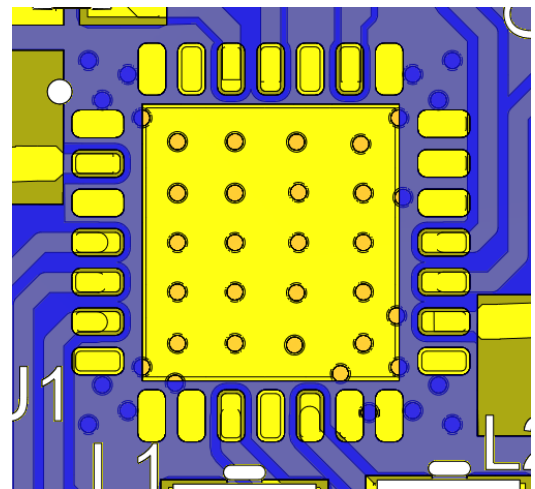

Tape and Reel Information

Standard T/R size = 500 pieces on a 7" reel. Tape and reel specifications for this part are also available on the QORVO website in the "Application Notes" section.

Carrier and Cover Tape Dimensions:

| Part | Feature | Symbol | Size (in) | Size (mm) |
|--------------|---------|--------|-----------|-----------|
| Cavity | Length | A0 | 0.209 | 5.3 |
| | Width | B0 | 0.209 | 5.3 |
| | Depth | K0 | 0.064 | 1.65 |
| | Pitch | P1 | 0.315 | 8.00 |
| Cover Tape | Width | C | 0.362 | 9.2 |
| Carrier Tape | Width | W | 0.472 | 12.00 |

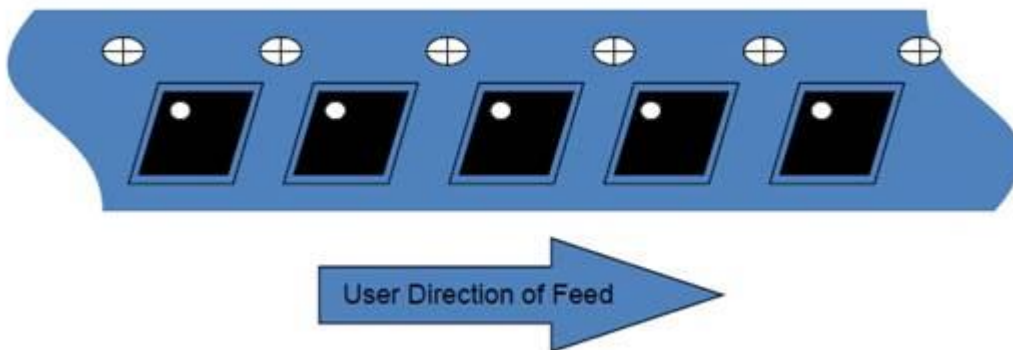
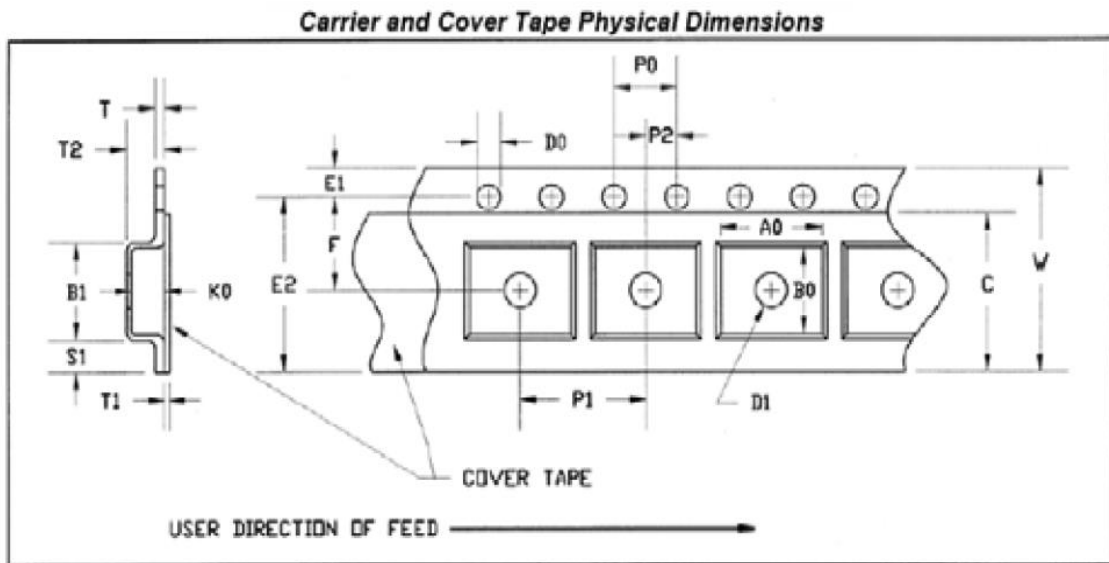

Assembly Notes

Compatible with lead-free soldering processes with 260°C peak reflow temperature.

This package is air-cavity and non-hermetic, and therefore cannot be subjected to aqueous washing. The use of no-clean solder to avoid washing after soldering is highly recommended.

Contact plating: Ni-Pd-Au.

Solder rework not recommended.

Recommended Soldering Temperature Profile

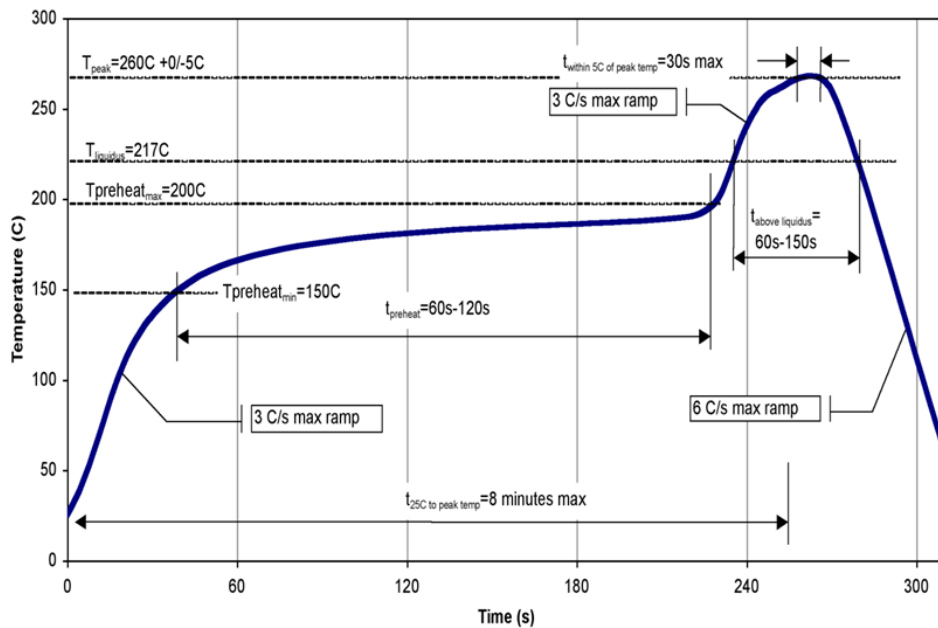

Handling Precautions

| Parameter | Rating | Standard |
|----------------------------------|----------|--------------------------|
| ESD – Human Body Model (HBM) | Class 1A | ESDA / JEDEC JS-001-2012 |
| MSL – Moisture Sensitivity Level | Level 1 | IPC/JEDEC J-STD-020 |



Caution!
ESD-Sensitive Device

RoHS Compliance

This product is compliant with the 2011/65/EU RoHS directive (Restrictions on the Use of Certain Hazardous Substances Electrical and Electronic Equipment), as amended by Directive 2015/863/EU. This product also has the following attributes

- Lead Free
- Halogen Free (Chlorine, Bromine)
- Antimony Free
- TBBP-A (C₁₅H₁₂Br₄O₂) Free
- PFOS Free
- SVHC Free

Contact Information

For the latest specifications, additional product information, worldwide sales and distribution locations:

Tel: 1-844-890-8163

Web: www.qorvo.com

Email: customer.support@qorvo.com

Important Notice

The information contained herein is believed to be reliable; however, Qorvo makes no warranties regarding the information contained herein and assumes no responsibility or liability whatsoever for the use of the information contained herein. The information contained herein is subject to change without notice. Customers should obtain and verify the latest relevant information before placing orders for Qorvo products. The information contained herein or any use of such information do not grant, explicitly or implicitly, to any party any patent rights, licenses, or any other intellectual property rights, whether with regard to such information itself or anything described by such information. **THIS INFORMATION DOES NOT CONSTITUTE A WARRANTY WITH RESPECT TO THE PRODUCTS DESCRIBED HEREIN, AND QORVO HEREBY DISCLAIMS ALL WARRANTIES WITH RESPECT TO SUCH PRODUCTS WHETHER EXPRESS OR IMPLIED BY LAW, COURSE OF DEALING, COURSE OF PERFORMANCE, USAGE OF TRADE OR OTHERWISE, INCLUDING THE IMPLIED WARRANTIES OF MERCHANTABILITY AND FITNESS FOR A PARTICULAR PURPOSE.**

Without limiting the generality of the foregoing, Qorvo products are not warranted or authorized for use as critical component in medical, life-saving, or life-sustaining applications, or other applications where a failure would reasonably be expected to cause severe personal injury or death.

Copyright 2020 © Qorvo, Inc. | Qorvo is a registered trademark of Qorvo, Inc.



Стандарт Электрон Связь

Мы молодая и активно развивающаяся компания в области поставок электронных компонентов. Мы поставляем электронные компоненты отечественного и импортного производства напрямую от производителей и с крупнейших складов мира.

Благодаря сотрудничеству с мировыми поставщиками мы осуществляем комплексные и плановые поставки широчайшего спектра электронных компонентов.

Собственная эффективная логистика и склад в обеспечивает надежную поставку продукции в точно указанные сроки по всей России.

Мы осуществляем техническую поддержку нашим клиентам и предпродажную проверку качества продукции. На все поставляемые продукты мы предоставляем гарантию .

Осуществляем поставки продукции под контролем ВП МО РФ на предприятия военно-промышленного комплекса России , а также работаем в рамках 275 ФЗ с открытием отдельных счетов в уполномоченном банке. Система менеджмента качества компании соответствует требованиям ГОСТ ISO 9001.

Минимальные сроки поставки, гибкие цены, неограниченный ассортимент и индивидуальный подход к клиентам являются основой для выстраивания долгосрочного и эффективного сотрудничества с предприятиями радиоэлектронной промышленности, предприятиями ВПК и научно-исследовательскими институтами России.

С нами вы становитесь еще успешнее!

Наши контакты:

Телефон: +7 812 627 14 35

Электронная почта: sales@st-electron.ru

Адрес: 198099, Санкт-Петербург,
Промышленная ул, дом № 19, литера Н,
помещение 100-Н Офис 331