



Features :

- Universal AC input / Full range (up to 305VAC)
- Built-in active PFC function
- Protections: Short circuit / Over current / Over voltage / Over temperature
- Cooling by free air convection
- OCP point adjustable through output cable or internal potentiometer
- IP67 / IP65 design for indoor or outdoor installations
- "UL8750 listed" safety approved for HLG-80H-□BL
- Class 2 power unit
- Three in one dimming function (1~10Vdc or PWM signal or resistance)
- Suitable for LED lighting and moving sign applications
- Compliance to worldwide safety regulations for lighting
- Suitable for dry / damp / wet locations
- 5 years warranty (Note.10)



HLG-80H-12[A] Blank : IP67 rated. Cable for I/O connection.
 A : IP65 rated. Output voltage and constant current level can be adjusted through internal potentiometer.
 B : IP67 rated. Constant current level adjustable through output cable with 1~10Vdc or 10V PWM signal or resistance.
 BL (option) : Contact MEAN WELL for details.
 D (option) : IP67 rated. Timer dimming function, contact MEAN WELL for details.

SPECIFICATION

MODEL	HLG-80H-12	HLG-80H-15	HLG-80H-20	HLG-80H-24	HLG-80H-30	HLG-80H-36	HLG-80H-42	HLG-80H-48	HLG-80H-54		
OUTPUT	DC VOLTAGE	12V	15V	20V	24V	30V	36V	42V	48V	54V	
	CONSTANT CURRENT REGION Note.4	7.2 ~ 12V	9 ~ 15V	12 ~ 20V	14.4 ~ 24V	18 ~ 30V	21.6 ~ 36V	25.2 ~ 42V	28.8 ~ 48V	32.4 ~ 54V	
	RATED CURRENT	5A	5A	4A	3.4A	2.7A	2.3A	1.95A	1.7A	1.5A	
	RATED POWER	60W	75W	80W	81.6W	81W	82.8W	81.9W	81.6W	81W	
	RIPPLE & NOISE (max.) Note.2	150mVp-p	150mVp-p	150mVp-p	150mVp-p	200mVp-p	200mVp-p	200mVp-p	200mVp-p	200mVp-p	
	VOLTAGE ADJ. RANGE Note.6	10.8 ~ 13.5V	13.5 ~ 17V	17 ~ 22V	22 ~ 27V	27 ~ 33V	33 ~ 40V	38 ~ 46V	43 ~ 53V	49 ~ 58V	
	CURRENT ADJ. RANGE	Can be adjusted by internal potentiometer or through output cable									
	VOLTAGE TOLERANCE Note.3	±2.5%	±2.0%	±1.0%	±1.0%	±1.0%	±1.0%	±1.0%	±1.0%	±1.0%	
	LINE REGULATION	±0.5%	±0.5%	±0.5%	±0.5%	±0.5%	±0.5%	±0.5%	±0.5%	±0.5%	
	LOAD REGULATION	±2.0%	±1.5%	±1.0%	±0.5%	±0.5%	±0.5%	±0.5%	±0.5%	±0.5%	
SETUP, RISE TIME Note.8	200ms, 80ms / 115VAC at full load ; 1000ms, 80ms / 230VAC at full load ; B type 200ms, 200ms at 95% load ; 230VAC / 115VAC										
HOLD UP TIME (Typ.)	16ms at full load ; 230VAC / 115VAC										
INPUT	VOLTAGE RANGE Note.5	90 ~ 305VAC		127 ~ 431VDC							
	FREQUENCY RANGE	47 ~ 63Hz									
	POWER FACTOR (Typ.)	PF>0.96/115VAC, PF>0.96/230VAC, PF>0.94/277VAC at full load (Please refer to "Power Factor Characteristic" curve)									
	EFFICIENCY (Typ.)	88%	89%	90%	90.5%	91%	91%	91%	91%	91%	
	AC CURRENT (Typ.)	0.85A / 115VAC		0.425A / 230VAC		0.4A / 277VAC					
	INRUSH CURRENT (Typ.)	COLD START 70A/230VAC									
LEAKAGE CURRENT	<0.75mA / 277VAC										
PROTECTION	OVER CURRENT Note.4	95 ~ 108%									
	SHORT CIRCUIT	Protection type : Constant current limiting, recovers automatically after fault condition is removed									
	OVER VOLTAGE	14 ~ 17V	18 ~ 24V	23 ~ 30V	28 ~ 35V	35 ~ 43V	41 ~ 49V	48 ~ 58V	54 ~ 63V	59 ~ 68V	
	OVER TEMPERATURE	85°C ±10°C (RTH2) Protection type : Shut down o/p voltage, re-power on to recover									
ENVIRONMENT	WORKING TEMP.	-40 ~ +70°C (Refer to "Derating Curve")									
	WORKING HUMIDITY	20 ~ 95% RH non-condensing									
	STORAGE TEMP., HUMIDITY	-40 ~ +80°C, 10 ~ 95% RH									
	TEMP. COEFFICIENT	±0.03%/°C (0 ~ 60°C)									
	VIBRATION	10 ~ 500Hz, 5G 12min./1cycle, period for 72min. each along X, Y, Z axes									
SAFETY & EMC	SAFETY STANDARDS Note.7	UL8750, CSA C22.2 No. 250.0-08(except for HLG-80H-48/54V & HLG-80H-48/54BL), UL8750 listed for HLG-80H-□BL EN61347-1, EN61347-2-13 independent, J61347-1, J61347-2-13, IP65 or IP67 approved ; Design refer to UL60950-1, TUV EN60950-1									
	WITHSTAND VOLTAGE	I/P-O/P: 3.75KVAC I/P-FG: 1.88KVAC O/P-FG: 0.5KVAC									
	ISOLATION RESISTANCE	I/P-O/P, I/P-FG, O/P-FG: 100M Ohms / 500VDC / 25°C / 70% RH									
	EMC EMISSION	Compliance to EN55015, EN61000-3-2 Class C (≥60% load) ; EN61000-3-3									
	EMC IMMUNITY	Compliance to EN61000-4-2,3,4,5,6,8,11, EN61547, EN55024, light industry level (surge 4KV), criteria A									
OTHERS	MTBF	357.8Khrs min. MIL-HDBK-217F (25°C)									
	DIMENSION	195.6*61.5*38.8mm (L*W*H)									
	PACKING	0.84Kg; 16pcs/14.4Kg/0.54CUFT									
NOTE	<ol style="list-style-type: none"> 1. All parameters NOT specially mentioned are measured at 230VAC input, rated load and 25°C of ambient temperature. 2. Ripple & noise are measured at 20MHz of bandwidth by using a 12" twisted pair-wire terminated with a 0.1uf & 47uf parallel capacitor. 3. Tolerance : includes set up tolerance, line regulation and load regulation. 4. Constant current operation region is within 60% ~ 100% rated output voltage. This is the suitable operation region for LED related applications, but please reconfirm special electrical requirements for some specific system design. 5. Derating may be needed under low input voltages. Please check the static characteristics for more details. 6. Type A only. 7. Safety and EMC design refer to EN60598-1, CNS15233, GB7000.1, FCC part18. 8. Length of set up time is measured at cold first start. Turning ON/OFF the power supply may lead to increase of the set up time. 9. The power supply is considered as a component that will be operated in combination with final equipment. Since EMC performance will be affected by the complete installation, the final equipment manufacturers must re-qualify EMC Directive on the complete installation again. 10. Refer to warranty statement. 										

Mechanical Specification

Case No.997A Unit:mm

Blank:(HLG-80H)

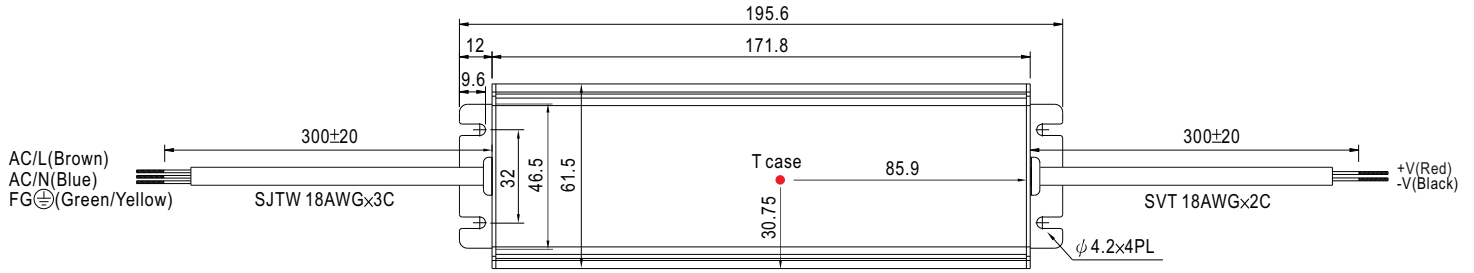

※ T case: Max. Case Temperature.



※IP67 rated. Cable for I/O connection.

A Type:(HLG-80H- _A)

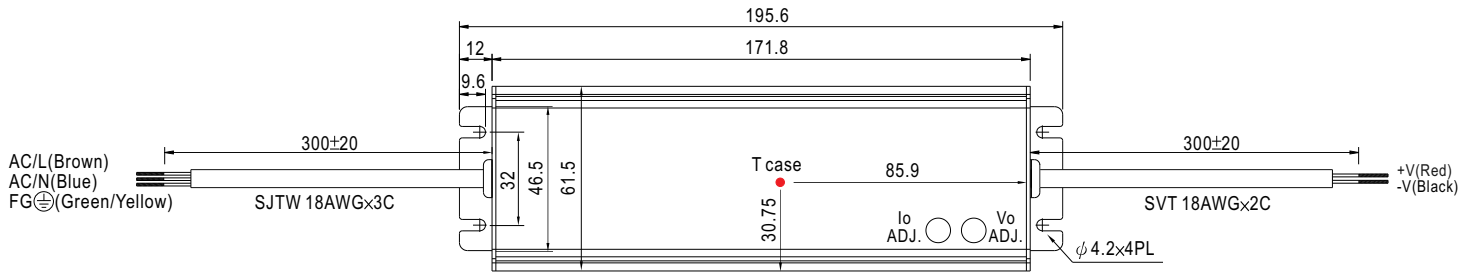

※ T case: Max. Case Temperature.



※ IP65 rated. Output voltage and constant current level can be adjusted through internal potentiometer.
(Can access by removing the rubber stopper on the case.)

B Type:(HLG-80H- _B)

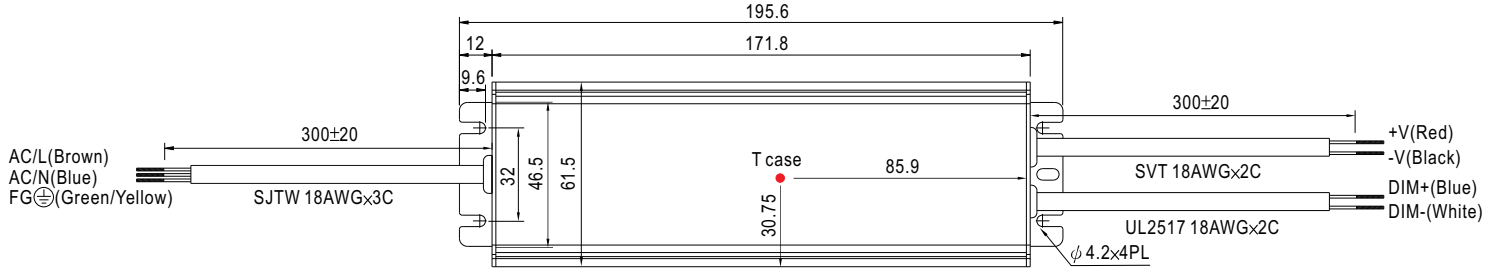

※ T case: Max. Case Temperature.



D Type(option):(HLG-80H-_D)

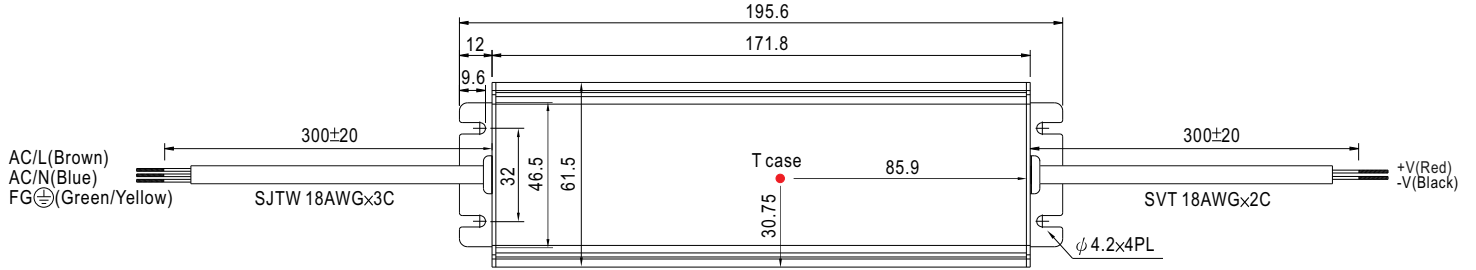

※ T case: Max. Case Temperature.

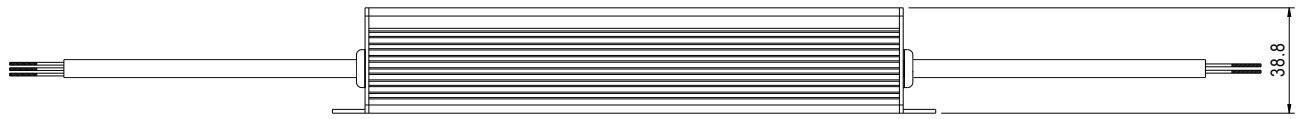

※ IP67 rated. Timer dimming function, contact MEAN WELL for details.

■ Block Diagram

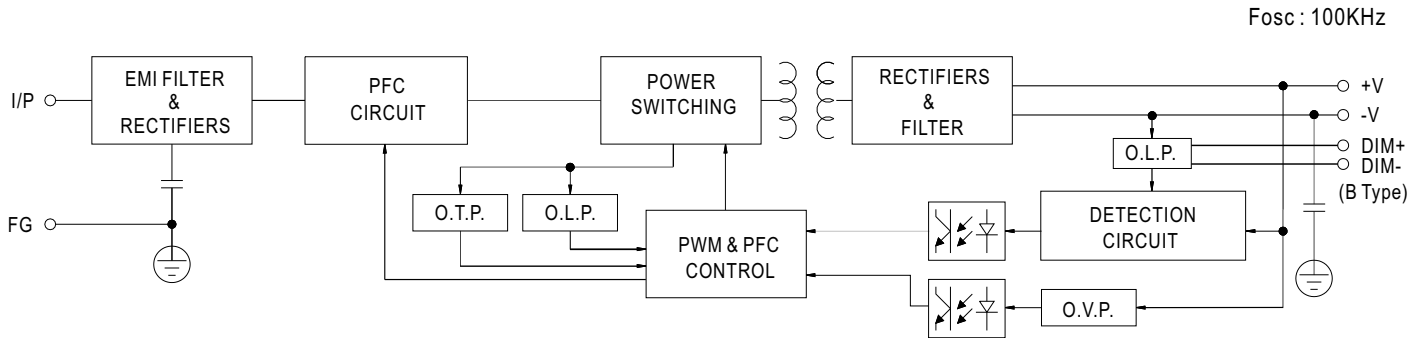

■ Derating Curve

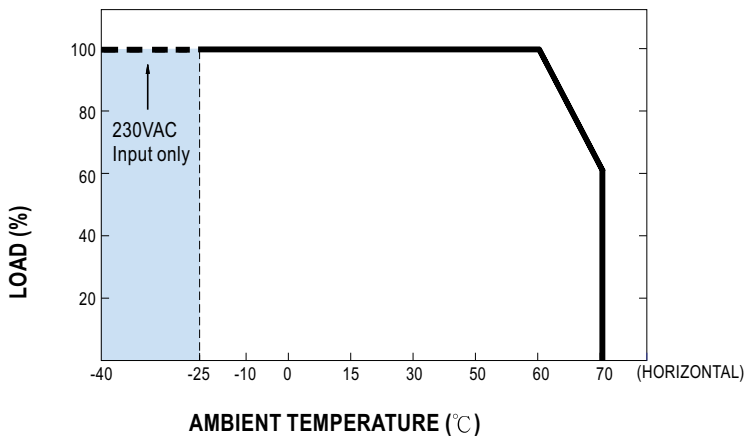

■ Static Characteristics

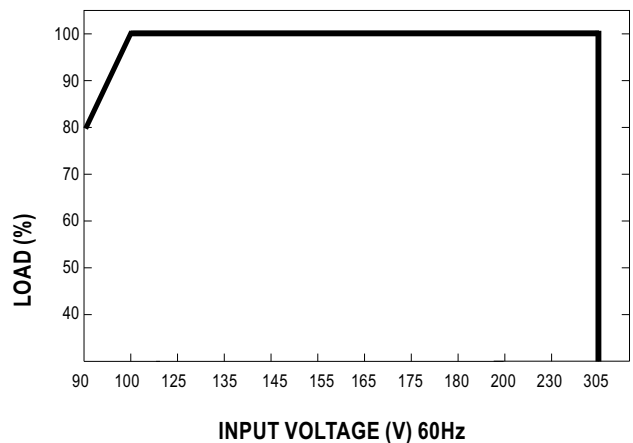

Power Factor Characteristic

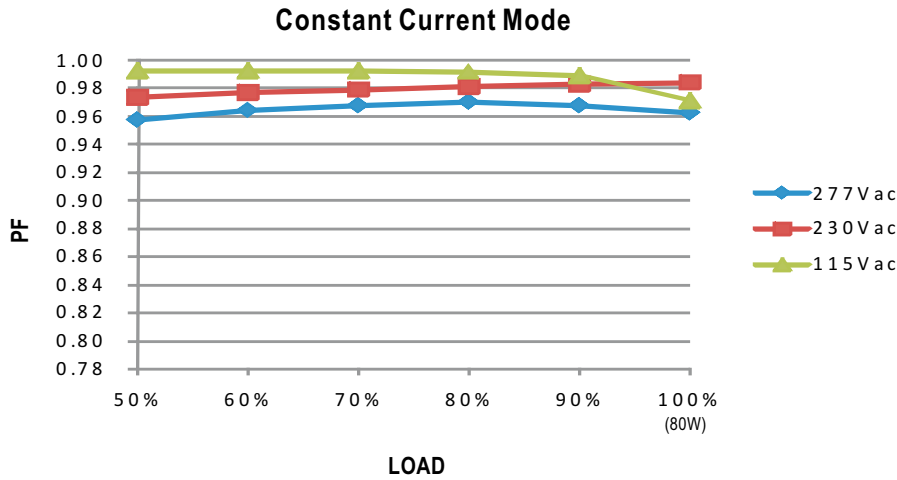

EFFICIENCY vs LOAD (48V Model)

HLG-80H series possess superior working efficiency that up to 91% can be reached in field applications.

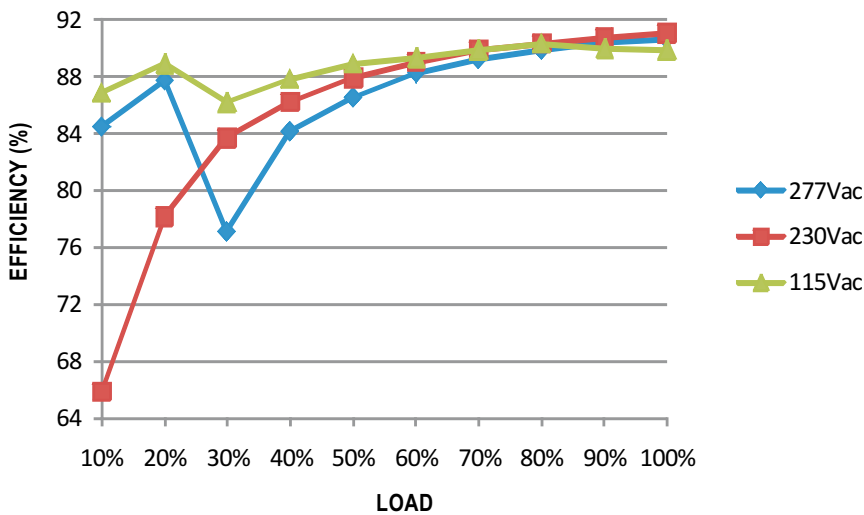

DRIVING METHODS OF LED MODULE

There are two major kinds of LED drive method "direct drive" and "with LED driver".

A typical LED power supply may either work in "constant voltage mode (CV) or constant current mode (CC)" to drive the LEDs.

Mean Well's LED power supply with CV+ CC characteristic can be operated at both CV mode [with LED driver, at area (A)] and CC mode [direct drive, at area (B)].

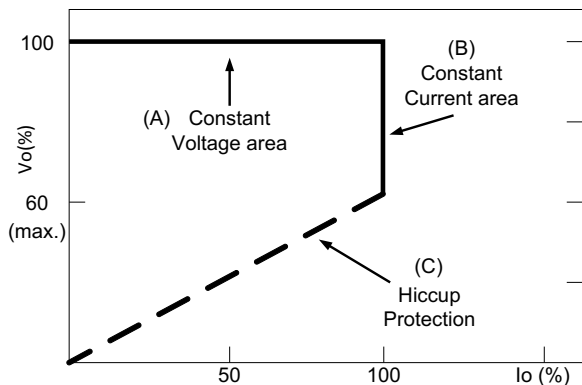

Typical LED power supply I-V curve

DIMMING OPERATION

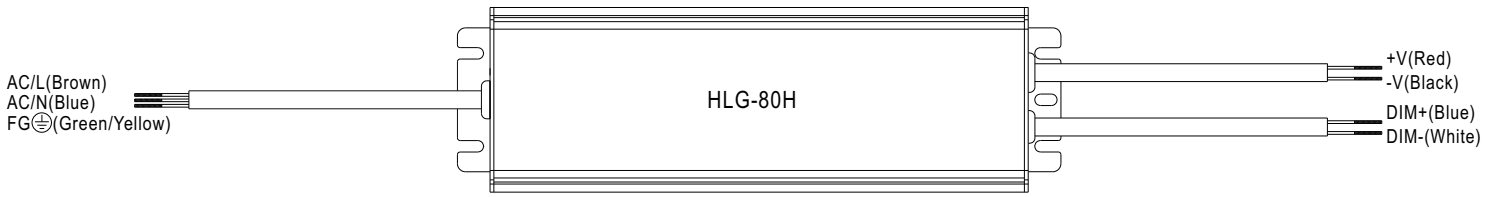

※ Built-in 3 in 1 dimming function, IP67 rated. Output constant current level can be adjusted through output cable by connecting a resistance or 1 ~ 10Vdc or 10V PWM signal between DIM+ and DIM-.

※ Please DO NOT connect "DIM-" to "-V".

※ Reference resistance value for output current adjustment (Typical)

Resistance value	Single driver	10KΩ	20KΩ	30KΩ	40KΩ	50KΩ	60KΩ	70KΩ	80KΩ	90KΩ	100KΩ	OPEN
	Multiple drivers (N=driver quantity for synchronized dimming operation)	10KΩ/N	20KΩ/N	30KΩ/N	40KΩ/N	50KΩ/N	60KΩ/N	70KΩ/N	80KΩ/N	90KΩ/N	100KΩ/N	-----
Percentage of rated current		10%	20%	30%	40%	50%	60%	70%	80%	90%	100%	102%~108%

※ 1 ~ 10V dimming function for output current adjustment (Typical)

Dimming value	1V	2V	3V	4V	5V	6V	7V	8V	9V	10V	OPEN
Percentage of rated current	10%	20%	30%	40%	50%	60%	70%	80%	90%	100%	102%~108%

※ 10V PWM signal for output current adjustment (Typical): Frequency range :100Hz ~ 3KHz

Duty value	10%	20%	30%	40%	50%	60%	70%	80%	90%	100%	OPEN
Percentage of rated current	10%	20%	30%	40%	50%	60%	70%	80%	90%	100%	102%~108%

※ Using the built-in dimming function on B-type model can't turn the lighting fixture totally dark. Please refer to the connection method below to achieve 0% brightness of the lighting fixture connecting to the LED power supply unit.

Dimming connection diagram for turning the lighting fixture ON/OFF :

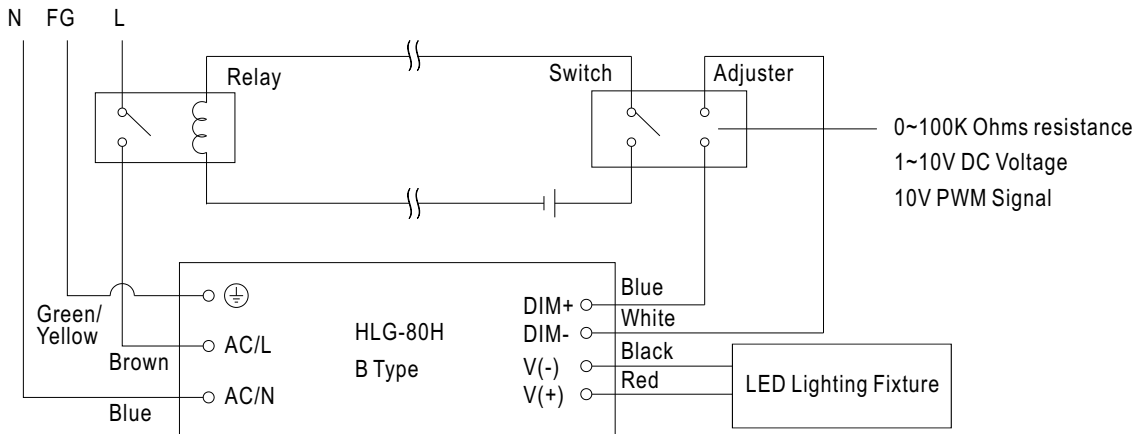

Using a switch and relay can turn ON/OFF the lighting fixture.

1. Output constant current level can be adjusted through output cable by connecting a resistance or 1~10Vdc or 10V PWM signal between DIM+ and DIM-.
2. The LED lighting fixture can be turned ON/OFF by the switch.

WATERPROOF CONNECTION

Waterproof connector

Waterproof connector can be assembled on the output cable of HLG-80H to operate in dry/wet/damp or outdoor environment.

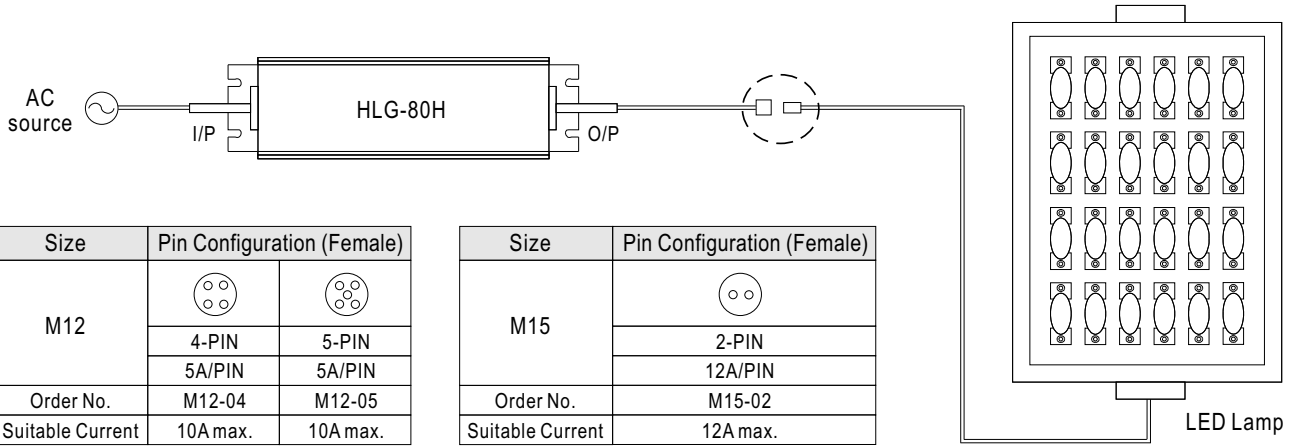

Cable Joiner

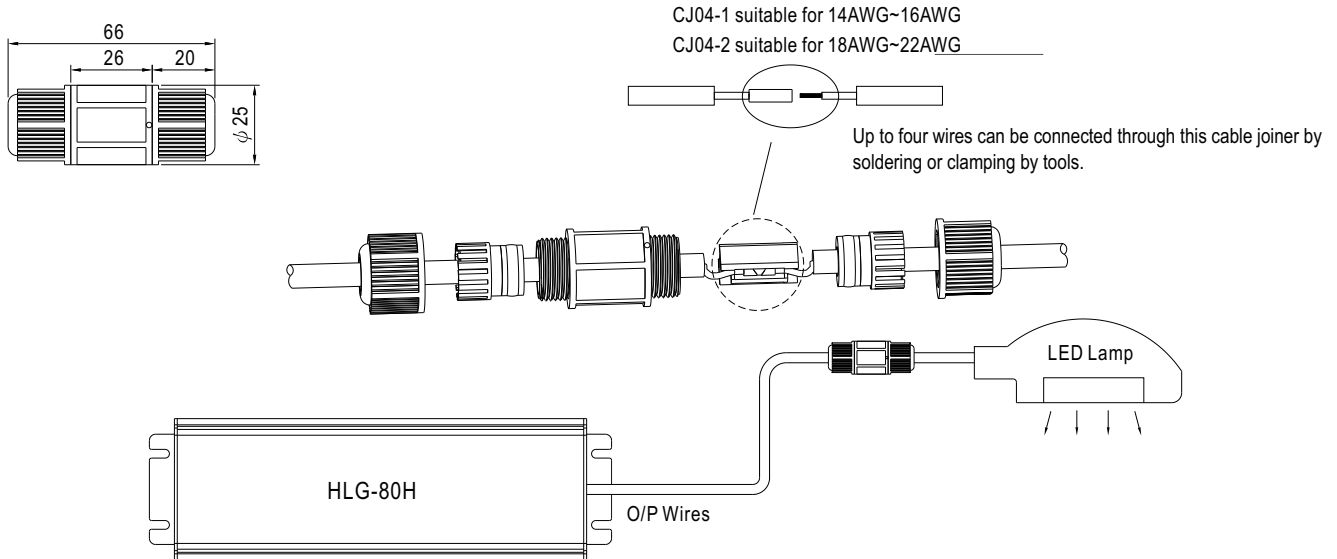

※CJ04 cable joiner can be purchased independently for user's own assembly.

MEAN WELL order No. : CJ04-1, CJ04-2.

Junction Box(Optional)

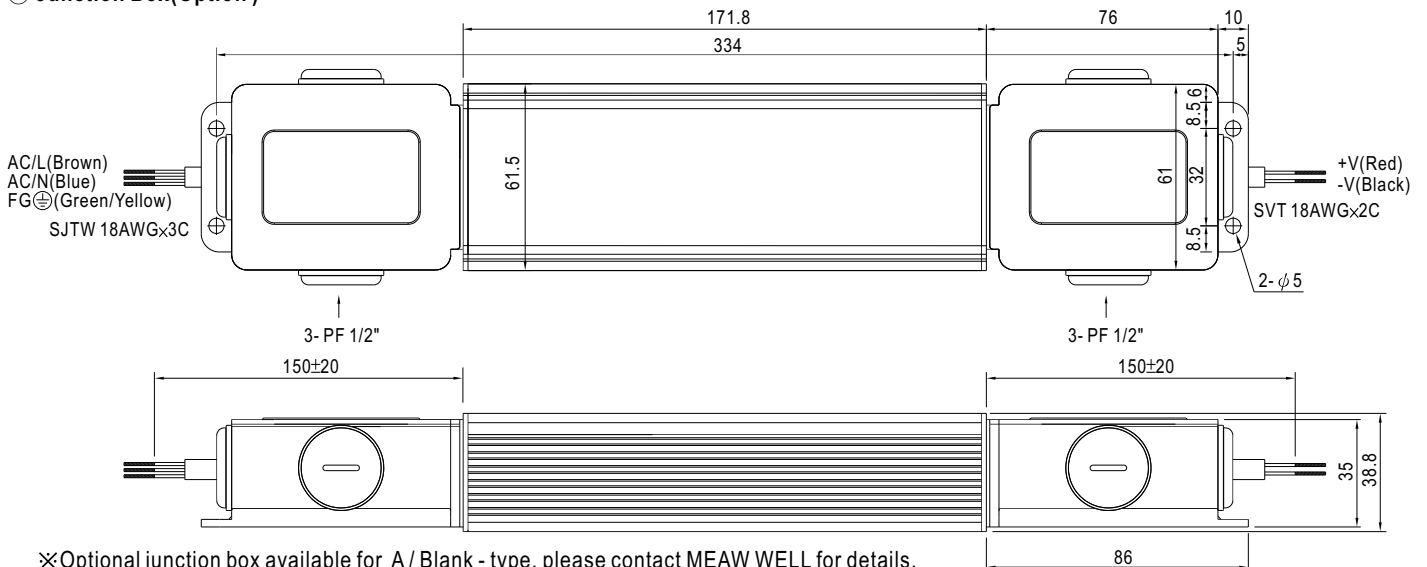

※Optional junction box available for A / Blank - type, please contact MEAN WELL for details.

※HLG-80H-□BL models with junction box at both input and output side are listed.



Стандарт Электрон Связь

Мы молодая и активно развивающаяся компания в области поставок электронных компонентов. Мы поставляем электронные компоненты отечественного и импортного производства напрямую от производителей и с крупнейших складов мира.

Благодаря сотрудничеству с мировыми поставщиками мы осуществляем комплексные и плановые поставки широчайшего спектра электронных компонентов.

Собственная эффективная логистика и склад в обеспечивает надежную поставку продукции в точно указанные сроки по всей России.

Мы осуществляем техническую поддержку нашим клиентам и предпродажную проверку качества продукции. На все поставляемые продукты мы предоставляем гарантию .

Осуществляем поставки продукции под контролем ВП МО РФ на предприятия военно-промышленного комплекса России , а также работаем в рамках 275 ФЗ с открытием отдельных счетов в уполномоченном банке. Система менеджмента качества компании соответствует требованиям ГОСТ ISO 9001.

Минимальные сроки поставки, гибкие цены, неограниченный ассортимент и индивидуальный подход к клиентам являются основой для выстраивания долгосрочного и эффективного сотрудничества с предприятиями радиоэлектронной промышленности, предприятиями ВПК и научно-исследовательскими институтами России.

С нами вы становитесь еще успешнее!

Наши контакты:

Телефон: +7 812 627 14 35

Электронная почта: sales@st-electron.ru

Адрес: 198099, Санкт-Петербург,
Промышленная ул, дом № 19, литера Н,
помещение 100-Н Офис 331