

NJG1662MD7

■ ABSOLUTE MAXIMUM RATINGS

($T_a=+25^{\circ}\text{C}$, $Z_s=Z_l=50\Omega$)

PARAMETER	SYMBOL	CONDITIONS	RATINGS	UNITS
RF input power	P_{IN}	$V_{DD}=2.7\text{V}$, $V_{CTL}=0\text{V}/1.8\text{V}$ PC1,PC2,PA1,PA2,PB1,PB2	28	dBm
Supply voltage	V_{DD}	VDD terminal	5.0	V
Control voltage	V_{CTL}	VCTL terminal	5.0	V
Power dissipation	P_D	On PCB	1300	mW
Operating temp.	T_{opr}		-40~+85	$^{\circ}\text{C}$
Storage temp.	T_{stg}		-55~+150	$^{\circ}\text{C}$

■ ELECTRICAL CHARACTERISTICS

(General conditions: $T_a=+25^{\circ}\text{C}$, $Z_s=Z_l=50\Omega$, $V_{DD}=2.7\text{V}$, $V_{CTL(L)}=0\text{V}$, $V_{CTL(H)}=1.8\text{V}$, with application circuit)

PARAMETERS	SYMBOL	CONDITIONS	MIN	TYP	MAX	UNITS
Supply voltage	V_{DD}		1.5	2.7	4.5	V
Operating current	I_{DD}	$P_{IN}=0\text{dBm}$	-	16	30	μA
Control voltage (LOW)	$V_{CTL(L)}$		0	-	0.4	V
Control voltage (HIGH)	$V_{CTL(H)}$		1.3	1.8	V_{DD}	V
Control current	I_{CTL}	$f=2\text{GHz}$, $P_{IN}=0\text{dBm}$	-	5	10	μA
Insertion loss 1	LOSS1	$f=1\text{GHz}$, $P_{IN}=0\text{dBm}$	-	0.3	0.45	dB
Insertion loss 2	LOSS2	$f=2\text{GHz}$, $P_{IN}=0\text{dBm}$	-	0.4	0.55	dB
Isolation 1	ISL1	PC1-PA1, PC2-PA2 PC1-PB1, PC2-PB2 $f=1\text{GHz}$, $P_{IN}=0\text{dBm}$	26	28	-	dB
Isolation 2	ISL2	PC1-PA1, PC2-PA2 PC1-PB1, PC2-PB2 $f=2\text{GHz}$, $P_{IN}=0\text{dBm}$	20	22	-	dB
Isolation 3	ISL3	PC1-PA1, PC2-PA2 PC1-PB1, PC2-PB2 $f=2.5\text{GHz}$, $P_{IN}=0\text{dBm}$	18	20	-	dB
Isolation 4	ISL4	PC1-PC2 port $f=2\text{GHz}$, $P_{IN}=0\text{dBm}$	26	28	-	dB
Phase error	PE	$f=2\text{GHz}$, between on paths	-3	0	3	deg
Input power at 0.2dB compression point	$P_{-0.2\text{dB}}$	$f=2\text{GHz}$	20	24	-	dBm
VSWR	VSWR	$f=2\text{GHz}$, On port	-	1.2	1.3	
Switching time	T_{SW}	50% CTL to 10%/90% RF	-	1.5	5.0	μs

■ TERMINAL INFORMATION

No.	SYMBOL	DESCRIPTION
1	GND	Ground terminal. Please connect this terminal with ground plane as close as possible for good RF performance.
2	PA2	This port is connected to PC2 terminal by applying High-level (1.3~4.5V) at VCTL terminal. An external capacitor is required to block DC voltage of internal circuit.
3	PB1	This port is connected to PC1 terminal by applying Low-level (0~0.4V) at VCTL terminal. An external capacitor is required to block DC voltage of internal circuit.
4	GND	Ground terminal. Please connect this terminal with ground plane as close as possible for good RF performance.
5	PB2	This port is connected to PC2 terminal by applying Low-level (0~0.4V) at VCTL terminal. An external capacitor is required to block DC voltage of internal circuit.
6	GND	Ground terminal. Please connect this terminal with ground plane as close as possible for good RF performance.
7	VDD	A supply voltage terminal (1.5~4.5V). Please place a bypass capacitor between this terminal and GND for avoiding RF noise from outside.
8	GND	Ground terminal. Please connect this terminal with ground plane as close as possible for good RF performance.
9	PC2	Common RF port. This port is connected with either of PA2 or PB2. An external capacitor is required to block DC voltage of internal circuit.
10	PC1	Common RF port. This port is connected with either of PA1 or PB1. An external capacitor is required to block DC voltage of internal circuit.
11	GND	Ground terminal. Please connect this terminal with ground plane as close as possible for good RF performance.
12	VCTL	Control signal input terminal. This terminal is set to high-level (1.3V~4.5V) or low-level (0~0.4V).
13	GND	Ground terminal. Please connect this terminal with ground plane as close as possible for good RF performance.
14	PA1	This port is connected to PC1 terminal by applying High-level (1.3~4.5V) at VCTL terminal. An external capacitor is required to block DC voltage of internal circuit.

NJG1662MD7

■ ELECTRICAL CHARACTERISTICS (With Application circuit, Loss of external circuit are excluded)

Insertion Loss vs. Frequency

($V_{DD}=2.7V, V_{CTL}=1.8V$)

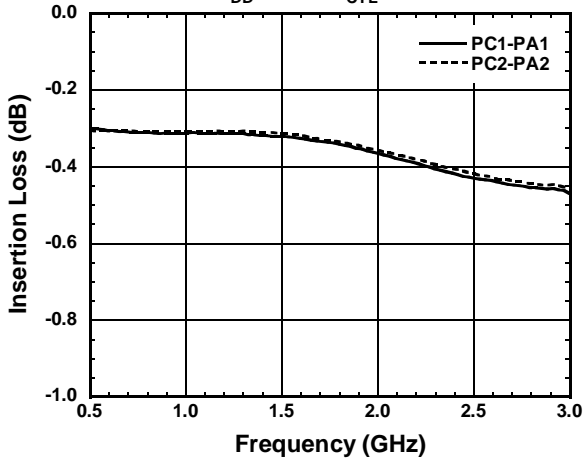

Insertion Loss vs. Frequency

($V_{DD}=2.7V, V_{CTL}=0V$)

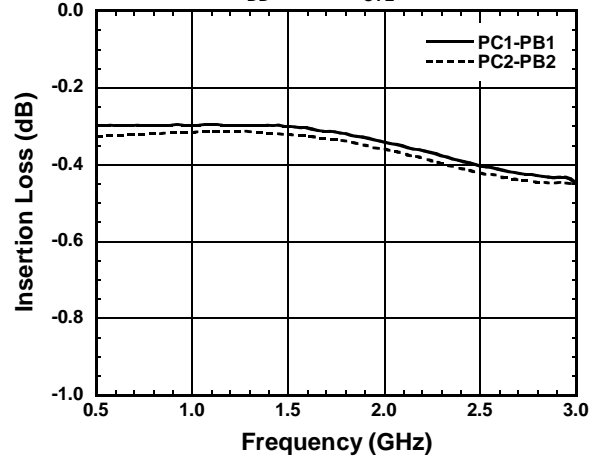

VSWR vs. Frequency

($V_{DD}=2.7V, V_{CTL1}=1.8V$)

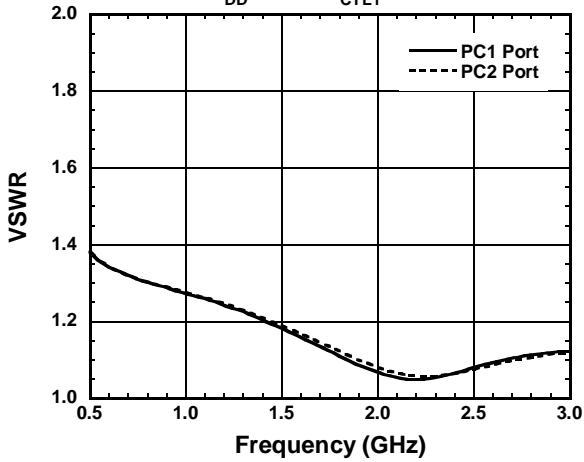

Isolation vs. Frequency

($V_{DD}=2.7V, V_{CTL}=1.8V$)

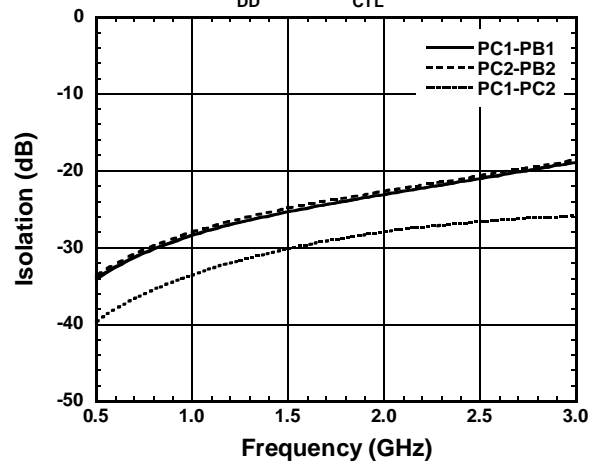

**PC1-PA1, PC2-PA2
Phase Error vs. Frequency**

($V_{DD}=2.7V, V_{CTL}=1.8V$)

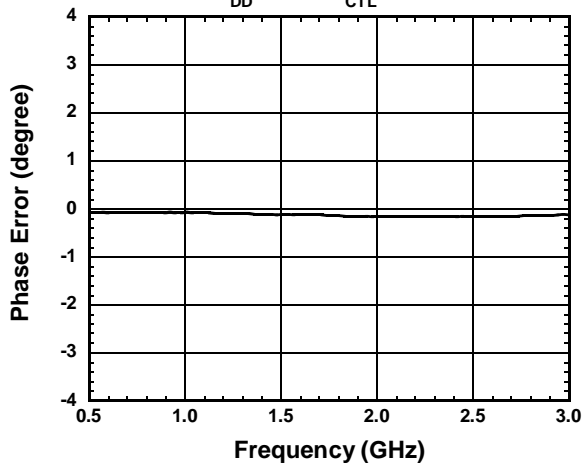

**PC1-PA1, PC2-PA2
Phase Error vs. Frequency**

($V_{DD}=2.7V, V_{CTL}=1.8V$)

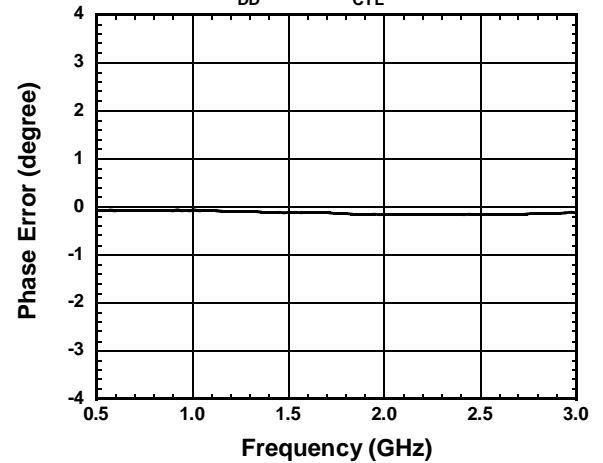

■ ELECTRICAL CHARACTERISTICS (With Application circuit, Loss of external circuit are excluded)

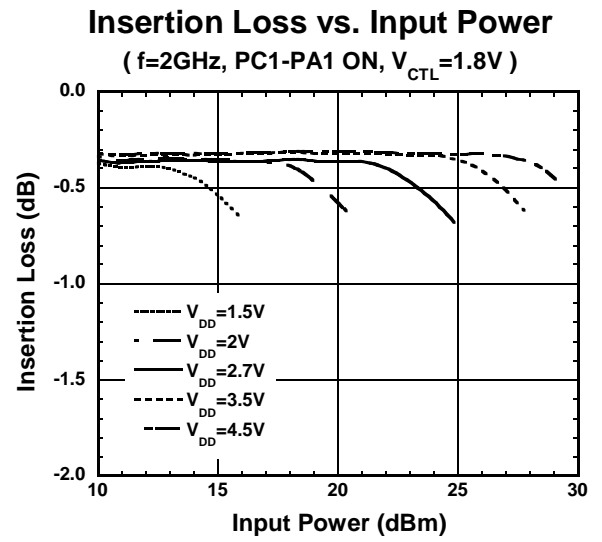
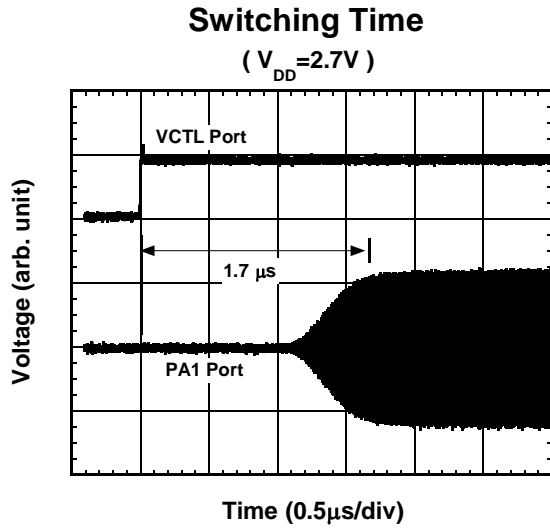

NJG1662MD7

■ ELECTRICAL CHARACTERISTICS (With Application circuit, Loss of external circuit are excluded)

Insertion Loss vs. Ambient Temperature

(PC1-PA1 ON, $V_{DD}=2.7V$, $V_{CTL}=1.8V$)

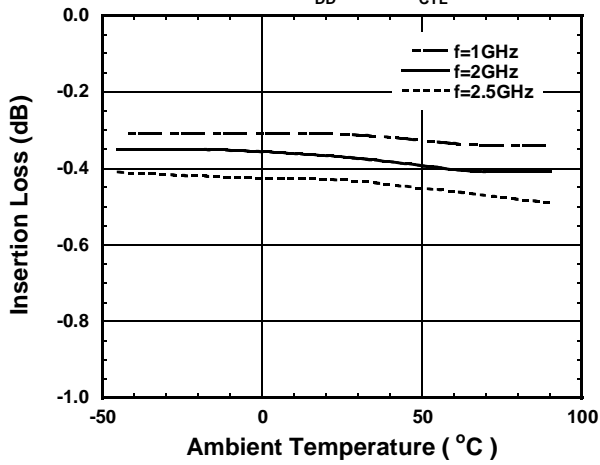

Insertion Loss vs. Frequency

(PC1-PA1 ON, $f=2GHz$, $V_{DD}=2.7V$, $V_{CTL}=1.8V$)

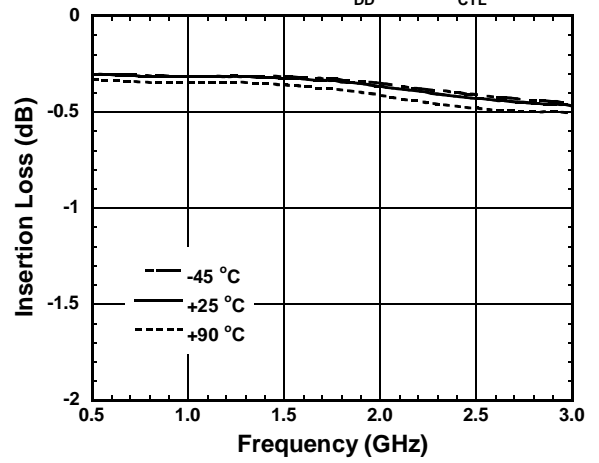

VSWR vs. Ambient Temperature

(PC1-PA1 ON, $V_{DD}=2.7V$, $V_{CTL}=1.8V$)

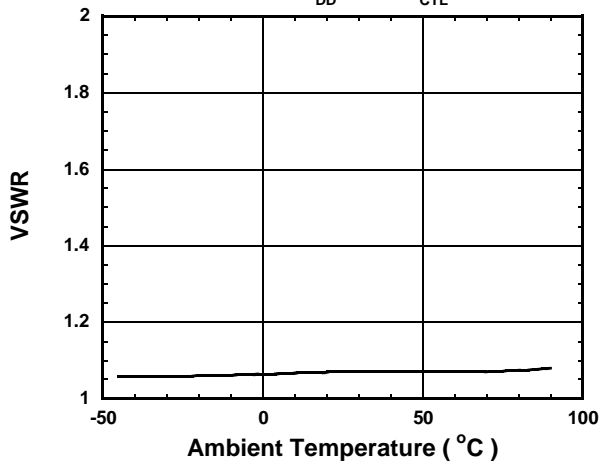

Isolation vs. Ambient Temperature

($f=2GHz$, $V_{DD}=2.7V$, $V_{CTL}=1.8V$)

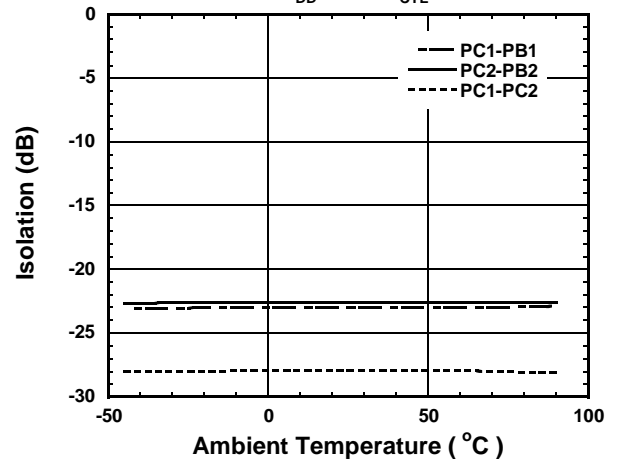

PC1-PA1, PC2-PA2 Phase Error vs. Frequency

($V_{DD}=2.7V$, $V_{CTL}=1.8V$)

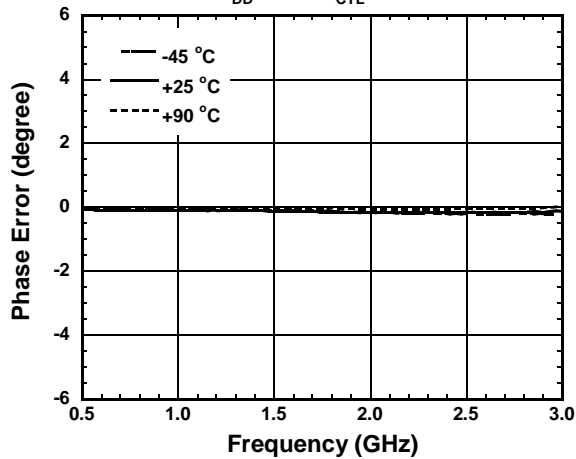

Phase Error vs. Ambient Temperature

($f=2GHz$, $V_{DD}=2.7V$, $V_{CTL(H)}=1.8V$, $V_{CTL(L)}=0V$)

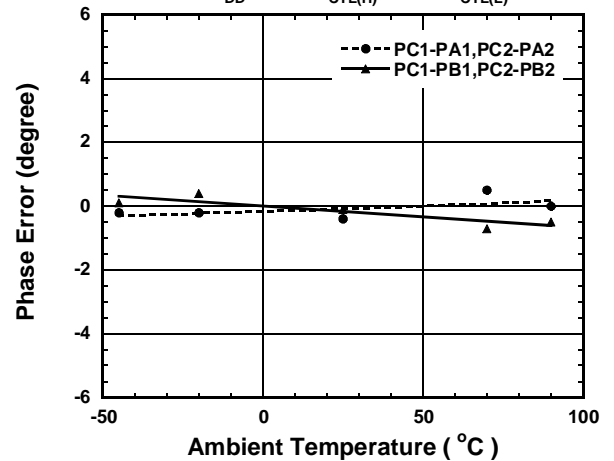

APPLICATION CIRCUIT

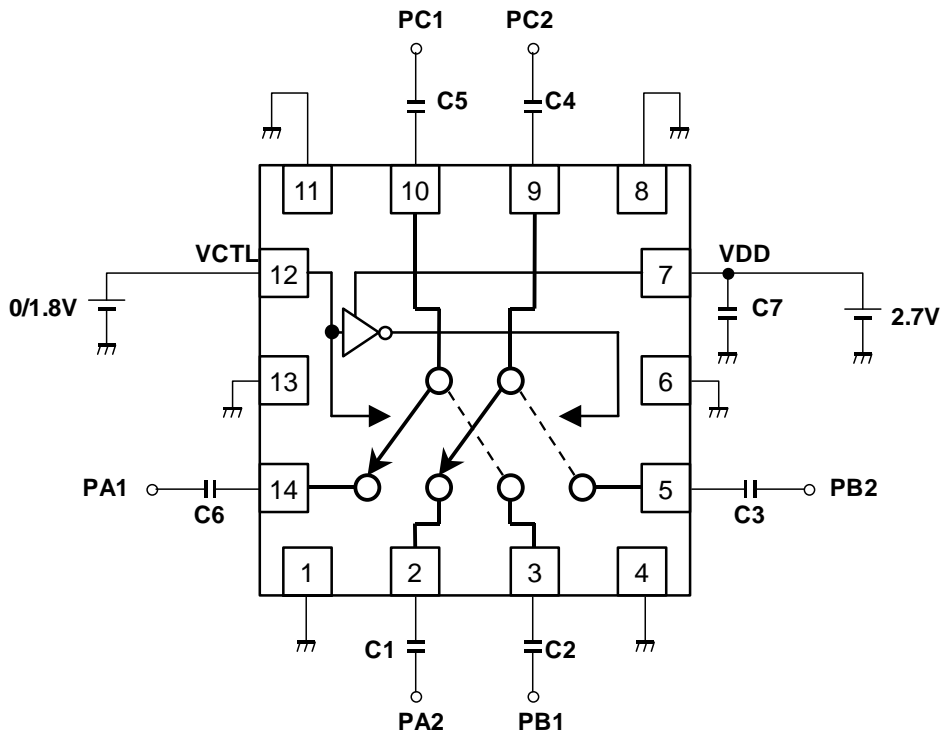

PARTS LIST

Part ID	Value	Notes
C1~C6	56pF	MURATA (GRM15)
C7	1000pF	

TEST PCB LAYOUT

(TOP VIEW)

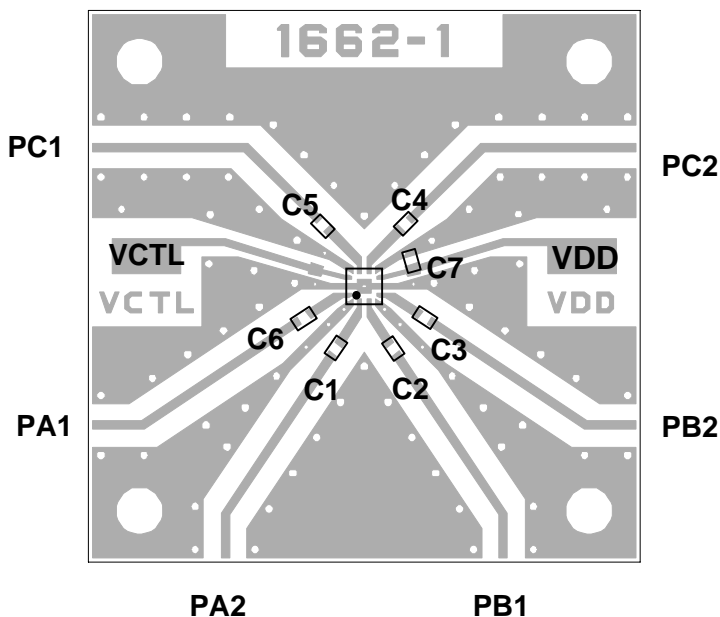

PCB: FR-4, t=0.2mm

Capacitor Size: 1005

Strip Line Width: 0.4mm

PCB Size: 26 x 26mm

Losses of PCB, capacitors and connectors

Frequency (GHz)	Loss (dB)
1.0	0.38
2.0	0.51
2.5	0.55



Стандарт Электрон Связь

Мы молодая и активно развивающаяся компания в области поставок электронных компонентов. Мы поставляем электронные компоненты отечественного и импортного производства напрямую от производителей и с крупнейших складов мира.

Благодаря сотрудничеству с мировыми поставщиками мы осуществляем комплексные и плановые поставки широчайшего спектра электронных компонентов.

Собственная эффективная логистика и склад в обеспечивает надежную поставку продукции в точно указанные сроки по всей России.

Мы осуществляем техническую поддержку нашим клиентам и предпродажную проверку качества продукции. На все поставляемые продукты мы предоставляем гарантию .

Осуществляем поставки продукции под контролем ВП МО РФ на предприятия военно-промышленного комплекса России , а также работаем в рамках 275 ФЗ с открытием отдельных счетов в уполномоченном банке. Система менеджмента качества компании соответствует требованиям ГОСТ ISO 9001.

Минимальные сроки поставки, гибкие цены, неограниченный ассортимент и индивидуальный подход к клиентам являются основой для выстраивания долгосрочного и эффективного сотрудничества с предприятиями радиоэлектронной промышленности, предприятиями ВПК и научно-исследовательскими институтами России.

С нами вы становитесь еще успешнее!

Наши контакты:

Телефон: +7 812 627 14 35

Электронная почта: sales@st-electron.ru

Адрес: 198099, Санкт-Петербург,
Промышленная ул, дом № 19, литера Н,
помещение 100-Н Офис 331