

## W6/W9 Series Magnetic Hydraulic P&B Circuit Breakers

- Designed for the international market. UL Recognized (UL1077 and UL1500), CSA Accepted and VDE approved.
- Ratings to 50 amps.
- Heavy duty #10-32 stud connections. (W9)
- Quick-connect or screw terminals. (W6)
- Several delay curve options.
- Choice of toggle or rocker actuator per pole or per unit (W6).
- Trip-free operation.

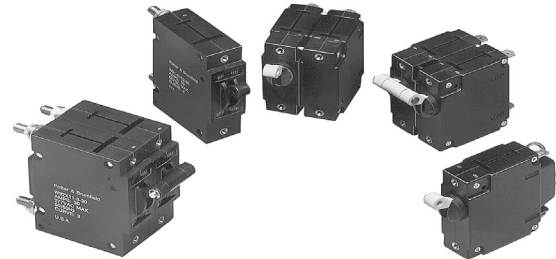

### Agency Approvals

**UL:** Recognized as Supplementary Protector under UL 1077. Available models meet Ignition Protection requirements in accordance with UL1500. File E69543

**CSA:** Accepted as a Supplementary Protector. File LR15734.

**VDE:** Approved to VDE 0642/EN 60 934 (Circuit Breakers for Equipment) License No. 73782

Users should thoroughly review the technical data before selecting a product part number. It is recommended that users also seek out the pertinent approvals files of the agencies/laboratories and review them to confirm the product meets the requirements for a given application.

### Electrical Data

#### Calibration:

Breakers will hold 100% of rated current.

Breakers may trip between 101% and 124% of rated load (134% for AC/DC units).

Breakers must trip at 125% of rated load and above (135% for AC/DC units).

**Dielectric Strength:** 50/60 Hz., 1500V: DC, 1100V

**Insulation Resistance:** 100 Megaohms at 500VDC

#### Endurance:

10,000 on/off cycles - 6000 at rated load, 4000 at no load.

Units tested at six cycles per minute, 1 second on and 9 seconds off at 25°C ambient.

#### Typical Resistance and Impedance

Current (Amps.)	DC Resistance (Ohms)	50/60 Impedance (Ohms)
0.2	90	90
1.0	1.2	1.2
2.0	0.28	0.28
5.0	0.04	0.04
10.0	0.013	0.013
20.0	0.004	0.005
30.0	0.0027	0.004
40.0	0.002	0.002
50.0	0.0015	0.0015

Tolerance: 0.1 - 4.99 ± 15%; 5 - 9.99 ± 20%; 10 - 15 ± 25%; 16 - 30 ± 50%.

### Mechanical/Environmental Data

**Operating Temperature:** -40°C to +85°C.

**Humidity:** Meets requirements of Mil-STD-202 method 103.

**Shock:** Tested per Mil-STD-202, method 213, test condition C (100g @ 6 ms)

**Vibration:** Tested per Mil-STD-202, method 201, 10-55 Hz., 0.06" (1.52mm) total excursion in 2 planes.

### Mechanical/Environmental Data (continued)

#### Fungus and Moisture Resistance:

Special moisture resistant finish applied to all ferrous parts. Plastic parts are made of inherently fungus resistant material.

#### Marking:

International "1" and "0" symbols are marked on the toggle for both W6 and W9. W9 units have "ON" and "OFF" molded into the area at the base of the toggle. On a special order basis, graphics can be imprinted on the rockers of rocker actuated W6 units. VDE approved versions of rocker actuated W6 breakers have their rockers imprinted with "1" and "0".

#### Mounting:

Units are mounted with two #6-32 screws from the front of the panel. Metric models for use with M3 x 0.5 screws are available. To maintain published performance specifications, units should not be mounted more than 90° from their normal upright position.

**Weight:** Approximately 2.5 ounces per pole.

### Approvals and Ratings Table 1

W6 Series		UL1077/CSA (All Circuit Functions)		
Maximum Voltage	Frequency (Hz)	Phase	Current Rating (Amps)	Interrupting Capacity (Amps)
65	DC	-	0.2 - 50	2,000
277	50/60	1	0.2 - 20	5,000
277	50/60	1	21 - 50	2,500
277/480	50/60	3Ø-Wye	0.2 - 20	5,000

W9 Series		UL1077/CSA (All Circuit Functions)		
Maximum Voltage	Frequency (Hz)	Phase	Current Rating (Amps)	Interrupting Capacity (Amps)
65	DC	-	0.2 - 50	2,000
277	50/60	1	0.2 - 50	5,000
277/480	50/60	3Ø-Wye	0.2 - 20	5,000

W6 or W9 Series		VDE (Circuit Function X)		
Maximum Voltage	Frequency (Hz)	Phase	Current Rating (Amps)	Interrupting Capacity (Amps)
65	DC	-	0.2 - 50	2,000
250	50/60	1	0.2 - 30	5,000
250	50/60	1	31 - 50	2,000
415/240	50/60	3Ø	0.2 - 30	5,000

W6 or W9 Series		UL1500 (Circuit Function X)		
Maximum Voltage	Frequency (Hz)	Phase	Current Rating (Amps)	Interrupting Capacity (Amps)
48	DC	-	0.2 - 50	3,000
125/250	50/60	1	0.2 - 50	1,000
250	50/60	3Ø-Wye	0.2 - 50	1,000

W6/W9 Series Magnetic Hydraulic P&B Circuit Breakers (Continued)

Time vs Current Trip Curves For W6 Series and W9 Series

AC 50/60 Hz.

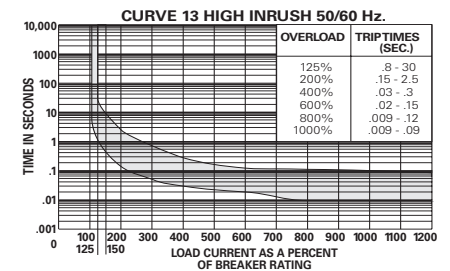
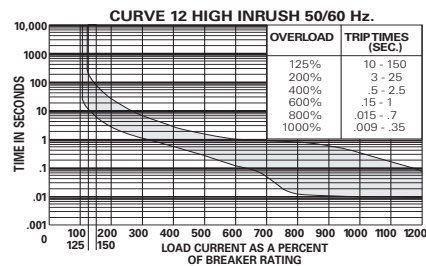
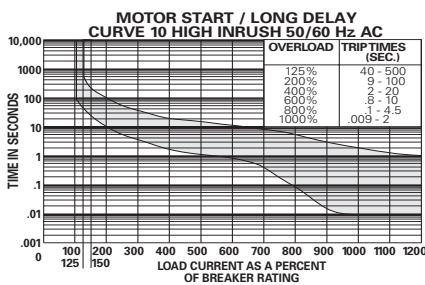
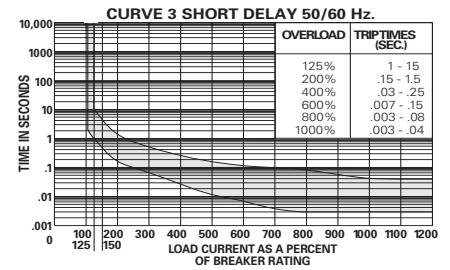
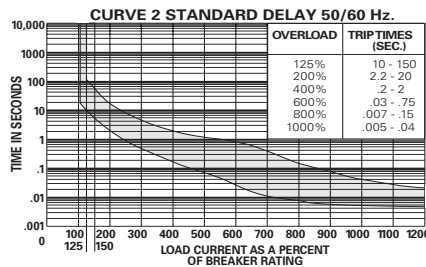

DC

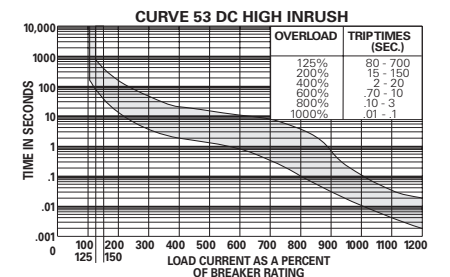
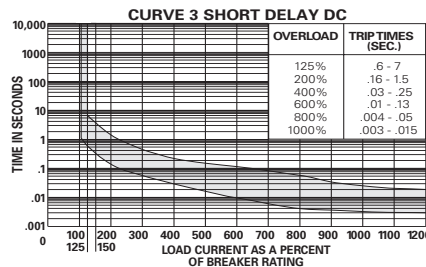
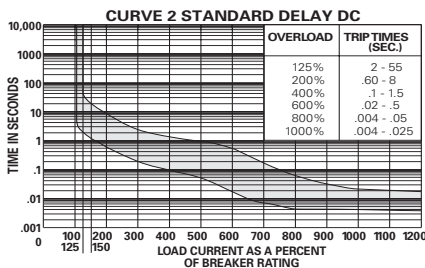

AC/DC

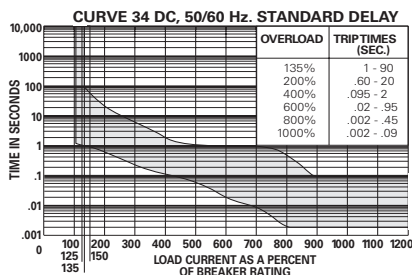

Note:

For instantaneous curves for all voltages refer to Curve 0 instantaneous under the AC 50/60 Hz. heading

**W6/W9 Series Magnetic Hydraulic P&B Circuit Breakers** (Continued)

**Product code structure**

Typical product code

**W 67- X 2 Q 1 2- 20**

**W6 Series**

**Circuit Breaker Mounting**

- W** #6-32 mounting threads
- M** M3.0 x 0.5 mounting threads

**Number of Poles**

- 67** Single Pole
- 68** Two Pole
- 69** Three Pole
- 70** Four Pole

**Circuit Function (Only X is VDE approved)**

- X** Series trip

**Actuator**

**One actuator per pole**

- 1** Black toggle    **3** Black rocker    **5** Red rocker    **9** Red toggle
- 2** White toggle    **4** White rocker    **6** Grey rocker

**One actuator per unit**

- 7** Black toggle    **8** White toggle    **J** Black rocker

**Termination**

- Q** .250" QC (DIN 46 244) [30A Max. UL/CSA; 25A Max. VDE]
- S** #8-32 screw [30A Max.]
- T** #10-32 screw [50A Max.]
- U** #8-32 screw, nickel plated, bent inward 30° [30A Max.]
- V** #10-32 screw, nickel plated, bent inward 30° [30A Max.]

**Notes:**

#10-32 termination must be used for **all** ratings of greater than 30 amps.  
#10-32 termination must be specified for circuit function D, but relay trip pole will be equipped with .250" QC.

**Maximum Line Voltage (see Table 1 for current ranges)**

- UL/CSA** 1 277VAC, 50/60 Hz.
- Types** 2 277/480VAC, 50/60 Hz. [20A Max.] (Requires insulating barriers, see outline dimension drawing)
- 5 65VDC
- 7 AC/DC 277VAC, 50/60 Hz. or 65VDC (Time delay curve 34 must be specified)
- 8 AC/DC 120VAC, 120/240VAC, 48VDC (Agency Approval M [UL1500] and time delay curve 34 must be specified)
- VDE** 1 250VAC, 415/240VAC
- Types** 5 65VDC
- 7 AC/DC 250VAC, 415/240VAC, 65VDC (Time delay curve 34 must be specified)

**Time Delay Curve**

- 0** Instantaneous
- 2** Standard delay
- 3** Short delay
- 53** DC high inrush
- 10** AC high inrush motor start / long delay
- 12** AC high inrush version of #2
- 13** AC high inrush version of #3
- 34** Combination AC/DC standard delay

**Amp Rating**

0.2	0.50	1.0	2.0	3.0	4.0	6.0	7.5	9.0	11.0	15.0	25.0	35.0	45.0	Consult factory for other values
0.25	0.75	1.5	2.5	3.5	5.0	7.0	8.0	10.0	12.0	20.0	30.0	40.0	50.0	

**Agency Approval**

- Blank** UL1077/CSA breaker
- V** VDE approved breaker
- M** UL1077/UL1500 ignition protected breaker

**Authorized distributors are more likely to stock the following items.**

W67-X2Q10-3	W67-X2Q12-10	W67-X2Q13-3	W67-X2Q50-5	W67-X2Q52-30	W68-X2Q12-10	W68-X2Q110-10	W69-X2Q12-25
W67-X2Q10-5	W67-X2Q12-15	W67-X2Q13-10	W67-X2Q50-10	W67-X2Q110-15	W68-X2Q12-15	W68-X2Q110-20	W69-X2Q12-30
W67-X2Q12-2	W67-X2Q12-20	W67-X2Q13-15	W67-X2Q52-5	W67-X2Q110-20	W68-X2Q12-20	W69-X2Q12-5	W69-X2Q110-20
W67-X2Q12-3	W67-X2Q12-30	W67-X2Q13-20	W67-X2Q52-10	W68-X2Q12-3	W68-X2Q12-25	W69-X2Q12-10	W69-X2Q110-30
W67-X2Q12-5	W67-X2Q13-1	W67-X2Q13-25	W67-X2Q52-15	W68-X2Q12-5	W68-X2Q12-30	W69-X2Q12-15	
W67-X2Q12-7	W67-X2Q13-2	W67-X2Q13-30	W67-X2Q52-20	W68-X2Q12-7	W68-X2Q13-15	W69-X2Q12-20	

**W6/W9 Series Magnetic Hydraulic P&B Circuit Breakers** (Continued)

<b>Product code structure</b>	Typical product code	<b>W</b>	<b>91-</b>	<b>X</b>	<b>1</b>	<b>1</b>	<b>2-</b>	<b>20</b>	
<b>W9 Series</b>									
<b>Circuit Breaker Mounting</b>									
<b>W</b>	#6-32 mounting threads								
<b>M</b>	M3.0 x 0.5 mounting threads								
<b>Number of Poles</b>									
<b>91</b>	Single Pole								
<b>92</b>	Two Pole								
<b>93</b>	Three Pole								
<b>94</b>	Four Pole								
<b>Circuit Function (Only X is VDE approved)</b>									
<b>X</b>	Series trip								
<b>Actuator</b>									
<b>One actuator per pole</b>									
<b>1</b>	Black toggle								
<b>2</b>	White toggle								
<b>Maximum Line Voltage (see Table 1 for current ranges)</b>									
<b>UL/CSA</b>	1 277VAC, 50/60 Hz.								
<b>Types</b>	2 277/480VAC, 50/60 Hz. [20A Max.]								
	5 65VDC								
	7 AC/DC 277VAC, 50/60 Hz. or 65VDC (Time delay curve 34 must be specified)								
	8 AC/DC 120VAC, 120/240VAC, 48VDC (Agency Approval M [UL1500] and time delay curve 34 must be specified)								
<b>VDE</b>	1 250VAC, 415/240VAC								
<b>Types</b>	5 65VDC								
	7 AC/DC 250VAC, 415/240VAC, 65VDC (Time delay curve 34 must be specified)								
<b>Time Delay Curve</b>									
<b>0</b>	Instantaneous	<b>10</b>	AC high inrush motor start / long delay						
<b>2</b>	Standard delay	<b>12</b>	AC high inrush version of #2						
<b>3</b>	Short delay	<b>13</b>	AC high inrush version of #3						
<b>53</b>	DC high inrush	<b>34</b>	Combination AC/DC standard delay						
<b>Amp Rating</b>									
0.20	0.75	2.0	3.5	6.0	8.0	11.0	20.0	35.0	50.0
0.25	1.00	2.5	4.0	7.0	9.0	12.0	25.0	40.0	Consult factory for other values
0.50	1.50	3.0	5.0	7.5	10.0	15.0	30.0	45.0	
<b>Agency Approval</b>									
<b>Blank</b>	UL1077/CSA approved breaker								
<b>V</b>	VDE approved breaker								
<b>M</b>	UL1077/UL1500 ignition protected breaker								

**Authorized distributors are more likely to stock the following items.**

W91-X112-1	W91-X112-15	W91-X113-15	W91-X152-40	W92-X112-5	W92-X112-30	W92-X1110-30	W93-X112-30
W91-X112-2	W91-X112-20	W91-X150-5	W91-X152-50	W92-X112-7	W92-X112-40	W93-X112-5	W93-X112-40
W91-X112-3	W91-X112-40	W91-X152-10	W91-X1110-20	W92-X112-10	W92-X112-50	W93-X112-10	W93-X112-50
W91-X112-5	W91-X112-50	W91-X152-15	W92-X112-1	W92-X112-15	W92-X113-15	W93-X112-15	W93-X1110-20
W91-X112-7	W91-X113-5	W91-X152-20	W92-X112-2	W92-X112-20	W92-X113-20	W93-X112-20	W93-X1110-30
W91-X112-10	W91-X113-10	W91-X152-30	W92-X112-3	W92-X112-25	W92-X1110-20	W93-X112-25	

W6/W9 Series Magnetic Hydraulic P&B Circuit Breakers (Continued)

Outline Dimensions - Toggle Actuator Models

W6 Series

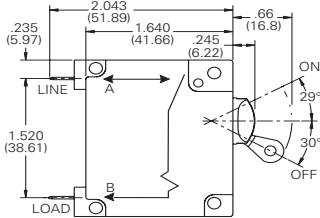

Panel Mounting Cutout

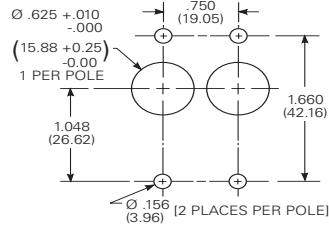

W6 Series - One Actuator Per Pole

1 Pole



2 Pole

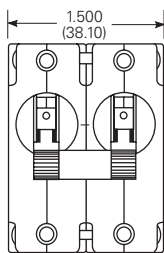

3 Pole



4 Pole



Note: Multi-pole models furnished with separate handle tie hardware

W6 Series - One Actuator Per Unit

1 Pole

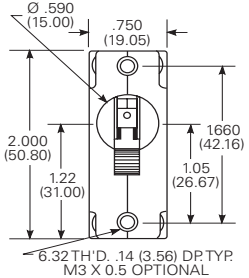

2 Pole



3 Pole



4 Pole



Note: 4-pole models furnished with separate handle tie hardware

480V Model with Barriers



Note: 3-pole model shown

Notes:

- Terminal protrusion dimensions are referenced from back of mounting panel
- Main terminals are male quick connect type .250 (6.35) wide x .031 (.79) thick x .377 (9.58) long. Optional 8-32 x .250 (6.35) or 10-32 x .250 (6.35) screw type
- Panel mounting cutout detail mtg. detail tol.: ± .005 (.13) unless noted. Add additional cutouts to correspond to number of poles. Outline drawing tolerance ± .015 (.35) unless noted

Termination Options

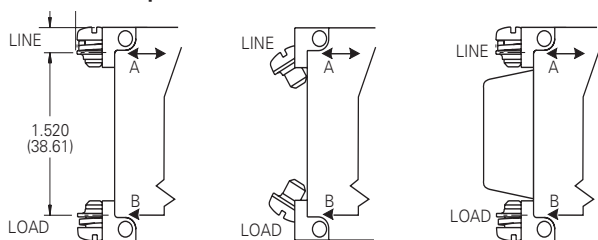

W6/W9 Series Magnetic Hydraulic P&B Circuit Breakers (Continued)

Outline Dimensions - Optional Toggle Guards

W6 Series

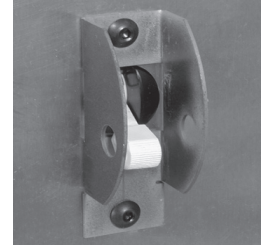
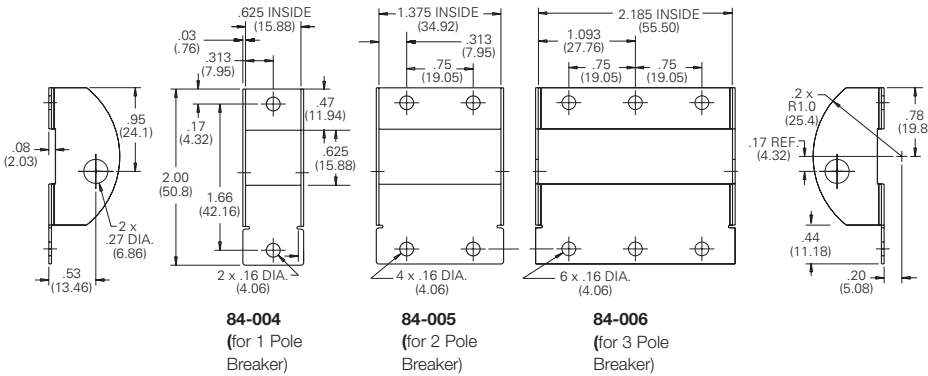

84-004 toggle guard shown with W67 series circuit breaker mounted in a panel.

Optional toggle guards may be ordered separately for use on W6 toggle actuator models. These guards help to prevent accidental operation and allow the breaker to be locked in the "off" position.

Outline Dimensions - Rocker Actuator Models

W6 Series

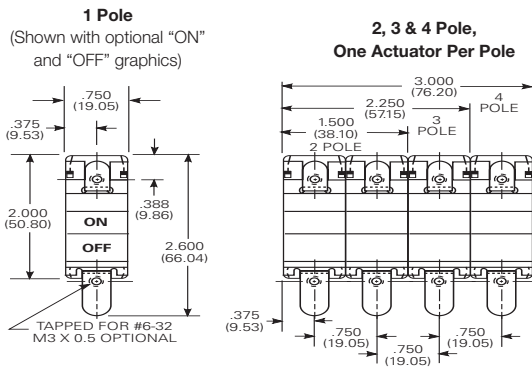
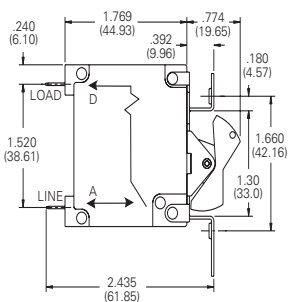

2, 3 & 4 Pole, One Actuator Per Unit

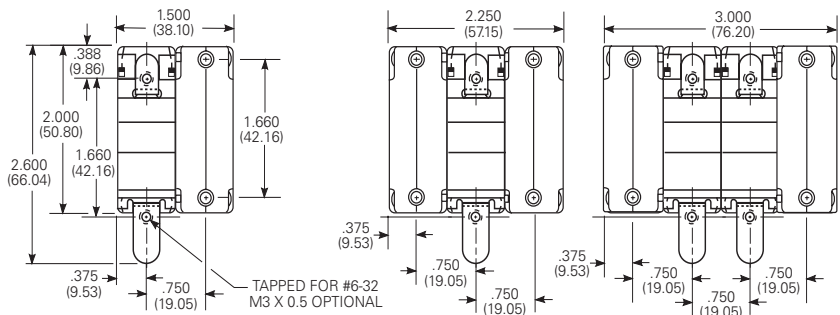

Panel Mounting Cutout

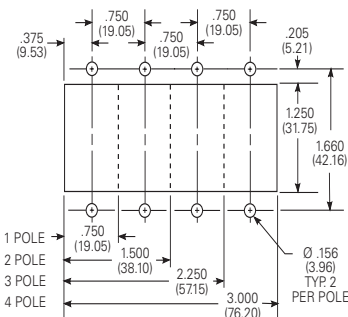

VDE Rocker Marking

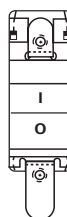

Notes:

1. Outline drawing tolerance  $\pm .015$  (.38) unless noted. Dimensions in brackets ( ) are in millimeters.
2. Mounting Detail Tol.  $\pm .005$  (.013) unless noted

**W6/W9 Series Magnetic Hydraulic P&B Circuit Breakers (Continued)**

**Outline Dimensions**

**W9 Series**

**Series Trip Model**

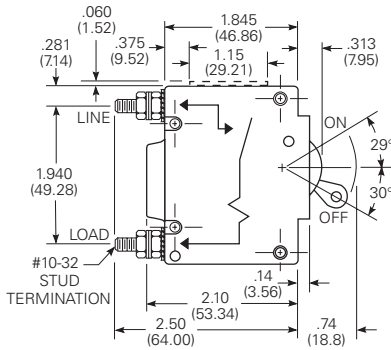

**Note:**

1. Top mounted plate (shown with broken line) is present only on UL1500 models

**Series Trip Model**

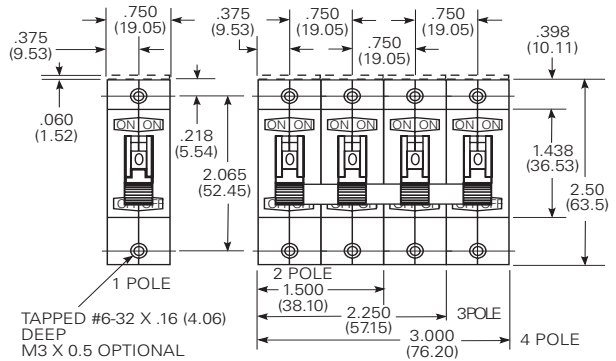

**Panel Mounting Cutout Detail**

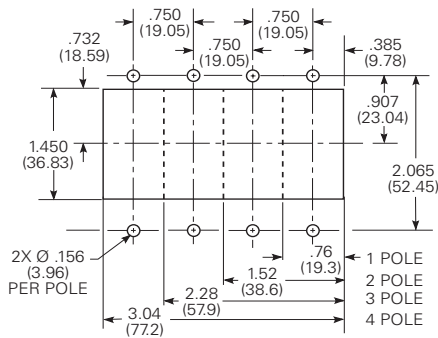

**Notes:**

1. Terminal protrusion dimensions are referenced from the back of the mounting panel
  2. Mounting detail tolerance  $\pm .005$  (13) unless noted
  3. Outline drawing tolerance  $\pm .015$  (.38) unless noted
- Dimensions in brackets ( ) are in millimeters.

**Disclaimer:**

While TE and its affiliates referenced herein have made every reasonable effort to ensure the accuracy of the information contained in this document, TE cannot assure that this information is error free. For this reason, TE does not make any representation or offer any guarantee that such information is accurate, correct, reliable or current. TE reserves the right to make any adjustments to the information at any time. TE expressly disclaims any implied warranty regarding the information contained herein, including, but not limited to, the implied warranties of merchantability or fitness for a particular purpose. TE's only obligations are those stated in TE's Standard Terms and Conditions of Sale. TE will in no case be liable for any incidental, indirect or consequential damages arising from or in connection with, including, but not limited to, the sale, resale, use or misuse of its products. Users should rely on their own judgment to evaluate the suitability of a product for a certain purpose and test each product for its intended application.

In case of any potential ambiguities or questions, please don't hesitate to contact us for clarification.





## Стандарт Электрон Связь

Мы молодая и активно развивающаяся компания в области поставок электронных компонентов. Мы поставляем электронные компоненты отечественного и импортного производства напрямую от производителей и с крупнейших складов мира.

Благодаря сотрудничеству с мировыми поставщиками мы осуществляем комплексные и плановые поставки широчайшего спектра электронных компонентов.

Собственная эффективная логистика и склад в обеспечивает надежную поставку продукции в точно указанные сроки по всей России.

Мы осуществляем техническую поддержку нашим клиентам и предпродажную проверку качества продукции. На все поставляемые продукты мы предоставляем гарантию .

Осуществляем поставки продукции под контролем ВП МО РФ на предприятия военно-промышленного комплекса России , а также работаем в рамках 275 ФЗ с открытием отдельных счетов в уполномоченном банке. Система менеджмента качества компании соответствует требованиям ГОСТ ISO 9001.

Минимальные сроки поставки, гибкие цены, неограниченный ассортимент и индивидуальный подход к клиентам являются основой для выстраивания долгосрочного и эффективного сотрудничества с предприятиями радиоэлектронной промышленности, предприятиями ВПК и научно-исследовательскими институтами России.

С нами вы становитесь еще успешнее!

### Наши контакты:

**Телефон:** +7 812 627 14 35

**Электронная почта:** [sales@st-electron.ru](mailto:sales@st-electron.ru)

**Адрес:** 198099, Санкт-Петербург,  
Промышленная ул, дом № 19, литера Н,  
помещение 100-Н Офис 331