

# MBR3045ST, MBRB3045CT-1

## SWITCHMODE™ Power Rectifier

### Features and Benefits

- Dual Diode Construction — Terminals 1 and 3 May Be Connected for Parallel Operation at Full Rating
- 45 V Blocking Voltage
- Low Forward Voltage Drop
- 175°C Operating Junction Temperature
- Pb-Free Packages are Available

### Applications

- Power Supply – Output Rectification
- Power Management
- Instrumentation

### Mechanical Characteristics

- Case: Epoxy, Molded
- Weight (Approximately): 1.9 Grams (TO-220AB)  
1.5 Grams (TO-262)
- Finish: All External Surfaces Corrosion Resistant and Terminal Leads are Readily Solderable
- Lead Temperature for Soldering Purposes:  
260°C Max. for 10 Seconds
- Epoxy Meets UL 94 V-0 @ 0.125 in

### MAXIMUM RATINGS

| Rating  | Symbol                                 | Value          | Unit             |
|---|--|----------------|------------------|
| Peak Repetitive Reverse Voltage<br>Working Peak Reverse Voltage<br>DC Blocking Voltage                          | $V_{RRM}$<br>$V_{RWM}$<br>$V_R$        | 45             | V                |
| Average Rectified Current<br>( $T_C = 130^\circ\text{C}$ )  | Per Device<br>Per Diode<br>$I_{F(AV)}$ | 30<br>15       | A                |
| Peak Repetitive Forward Current, per Diode<br>(Square Wave, $V_R = 45\text{ V}$ , 20 kHz)                       | $I_{FRM}$                              | 30             | A                |
| Non-Repetitive Peak Surge Current (Surge<br>Applied at Rated Load Conditions,<br>Halfwave, Single Phase, 60 Hz) | $I_{FSM}$                              | 150            | A                |
| Peak Repetitive Reverse Current, per Diode<br>(2.0 $\mu\text{s}$ , 1.0 kHz)                                     | $I_{RRM}$                              | 2.0            | A                |
| Storage Temperature Range   | $T_{stg}$                              | -65 to<br>+175 | °C               |
| Operating Junction Temperature (Note 1)   | $T_J$                                  | -65 to<br>+175 | °C               |
| Peak Surge Junction Temperature<br>(Forward Current Applied)  | $T_{J(pk)}$                            | 175            | °C               |
| Voltage Rate of Change (Rated $V_R$ )   | $dv/dt$                                | 10,000         | V/ $\mu\text{s}$ |

Stresses exceeding Maximum Ratings may damage the device. Maximum Ratings are stress ratings only. Functional operation above the Recommended Operating Conditions is not implied. Extended exposure to stresses above the Recommended Operating Conditions may affect device reliability.

1. The heat generated must be less than the thermal conductivity from Junction-to-Ambient:  $dP_D/dT_J < 1/R_{\theta JA}$ .



ON Semiconductor™

<http://onsemi.com>

## SCHOTTKY BARRIER RECTIFIER 30 AMPERES 45 VOLTS

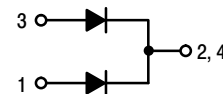

### MARKING DIAGRAMS

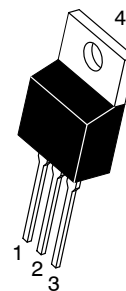

TO-220AB  
CASE 221A  
STYLE 6

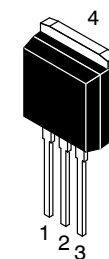

I²PAK (TO-262)  
CASE 418D  
PLASTIC



A = Assembly Location  
Y = Year  
WW = Work Week  
AKA = Polarity Designator  
G = Pb-Free Device

### ORDERING INFORMATION

See detailed ordering and shipping information in the package dimensions section on page 3 of this data sheet.

# MBR3045ST, MBRB3045CT-1

## THERMAL CHARACTERISTICS (Per Diode)

| Characteristic                       | Symbol          | Value | Unit          |
|--------------------------------------|-----------------|-------|---------------|
| Thermal Resistance, Junction to Case | $R_{\theta JC}$ | 1.5   | $^{\circ}C/W$ |

## ELECTRICAL CHARACTERISTICS (Per Diode)

|  |  |       |      |       |
|--|--|-------|------|-------|
| Instantaneous Forward Voltage (Note 2) | ( $i_F = 15$ Amp, $T_C = 25^{\circ}C$ )    | $v_F$ | 0.62 | Volts |
|  | ( $i_F = 15$ Amp, $T_C = 125^{\circ}C$ )   |       | 0.57 |       |
|  | ( $i_F = 30$ Amp, $T_C = 25^{\circ}C$ )    |       | 0.76 |       |
|  | ( $i_F = 30$ Amp, $T_C = 125^{\circ}C$ )   |       | 0.72 |       |
| Instantaneous Reverse Current (Note 2) | ( $V_R = 45$ Volts, $T_C = 25^{\circ}C$ )  | $I_R$ | 0.2  | mA    |
|  | ( $V_R = 45$ Volts, $T_C = 125^{\circ}C$ ) |       | 40   |       |

2 Pulse Test: Pulse Width = 300  $\mu s$ , Duty Cycle  $\leq 2.0\%$

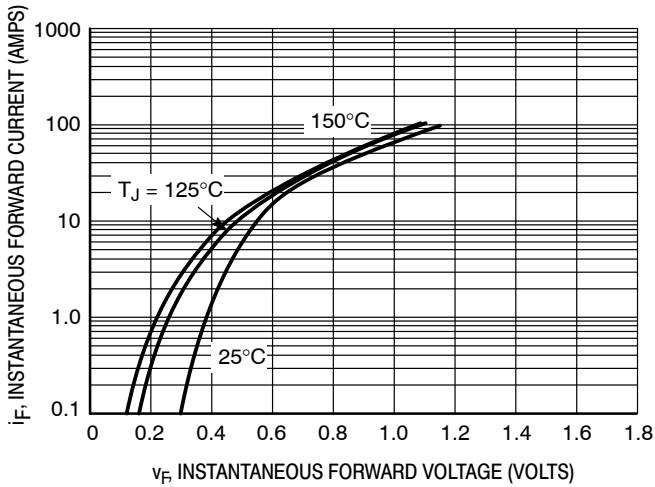

Figure 1. Typical Forward Voltage

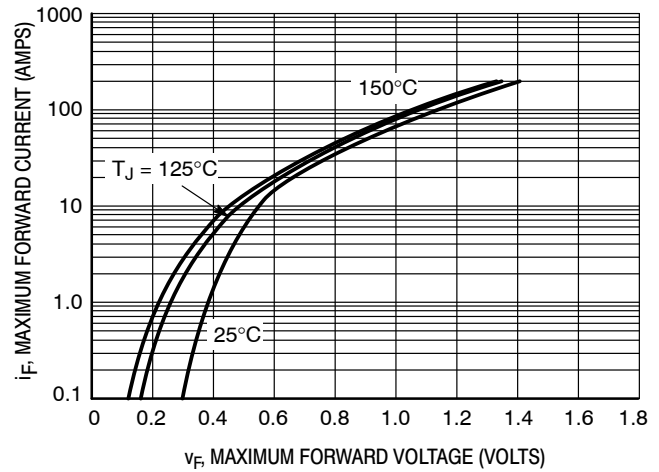

Figure 2. Maximum Reverse Current

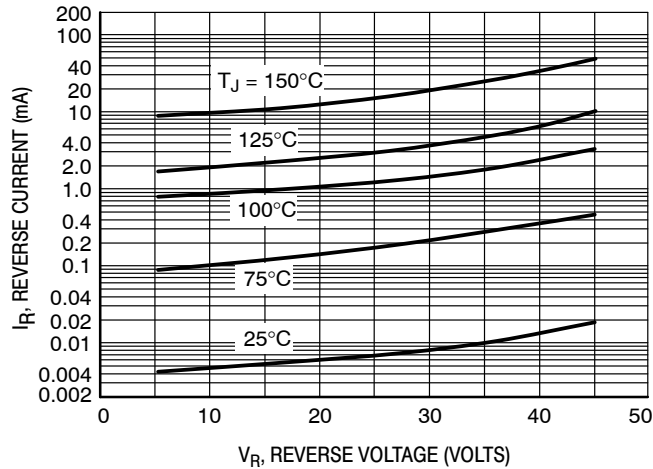

Figure 3. Typical Reverse Current

# MBR3045ST, MBRB3045CT-1

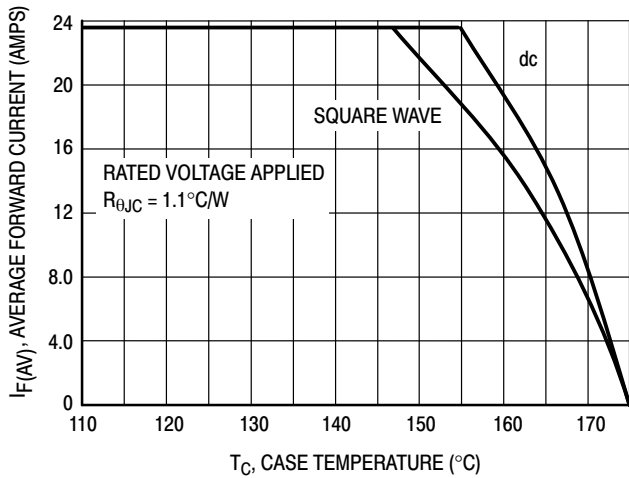

Figure 4. Current Derating, Case

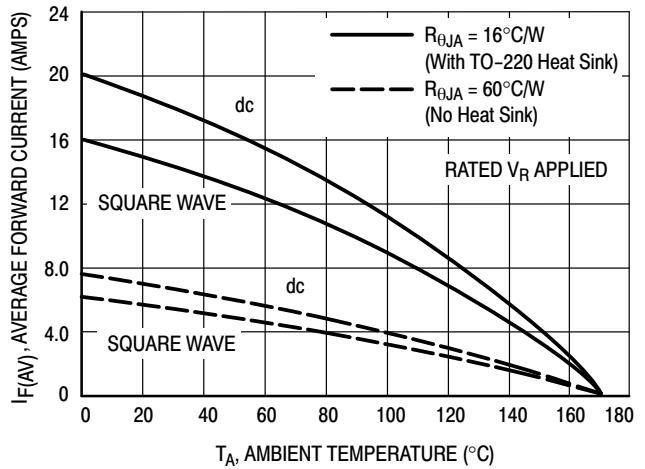

Figure 5. Current Derating, Ambient

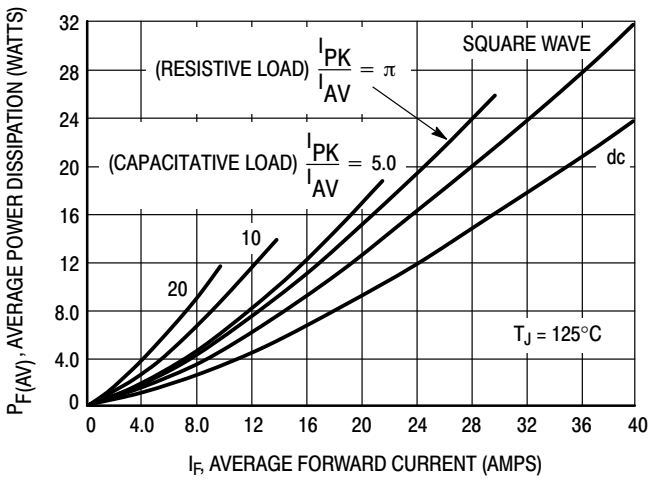

Figure 6. Forward Power Dissipation

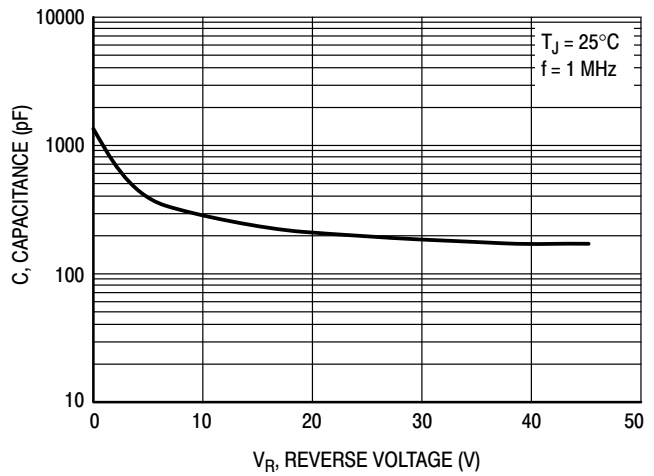

Figure 7. Capacitance

## ORDERING INFORMATION

| Device        | Package             | Shipping      |
|---------------|---------------------|---------------|
| MBR3045ST     | TO-220              | 50 Units/Rail |
| MBR3045STG    | TO-220<br>(Pb-Free) | 50 Units/Rail |
| MBRB3045CT-1  | TO-262              | 50 Units/Rail |
| MBRB3045CT-1G | TO-262<br>(Pb-Free) | 50 Units/Rail |

# MBR3045ST, MBRB3045CT-1

## PACKAGE DIMENSIONS

TO-220  
CASE 221A-09  
ISSUE AF

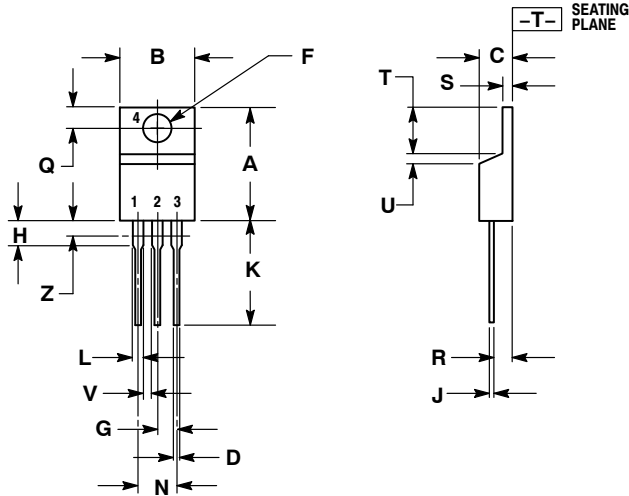

NOTES:

1. DIMENSIONING AND TOLERANCING PER ANSI Y14.5M, 1982.
2. CONTROLLING DIMENSION: INCH.
3. DIMENSION Z DEFINES A ZONE WHERE ALL BODY AND LEAD IRREGULARITIES ARE ALLOWED.

| DIM | INCHES |       | MILLIMETERS |       |
|-----|--------|-------|-------------|-------|
|     | MIN    | MAX   | MIN         | MAX   |
| A   | 0.570  | 0.620 | 14.48       | 15.75 |
| B   | 0.380  | 0.405 | 9.66        | 10.28 |
| C   | 0.160  | 0.190 | 4.07        | 4.82  |
| D   | 0.025  | 0.035 | 0.64        | 0.88  |
| F   | 0.142  | 0.161 | 3.61        | 4.09  |
| G   | 0.095  | 0.105 | 2.42        | 2.66  |
| H   | 0.110  | 0.155 | 2.80        | 3.93  |
| J   | 0.014  | 0.025 | 0.36        | 0.64  |
| K   | 0.500  | 0.562 | 12.70       | 14.27 |
| L   | 0.045  | 0.060 | 1.15        | 1.52  |
| N   | 0.190  | 0.210 | 4.83        | 5.33  |
| Q   | 0.100  | 0.120 | 2.54        | 3.04  |
| R   | 0.080  | 0.110 | 2.04        | 2.79  |
| S   | 0.045  | 0.055 | 1.15        | 1.39  |
| T   | 0.235  | 0.255 | 5.97        | 6.47  |
| U   | 0.000  | 0.050 | 0.00        | 1.27  |
| V   | 0.045  | ---   | 1.15        | ---   |
| Z   | ---    | 0.080 | ---         | 2.04  |

STYLE 6:

- PIN 1. ANODE
- CATHODE
- ANODE
- CATHODE

# MBR3045ST, MBRB3045CT-1

## PACKAGE DIMENSIONS

I<sup>2</sup>PAK (TO-262)  
CASE 418D-01  
ISSUE D

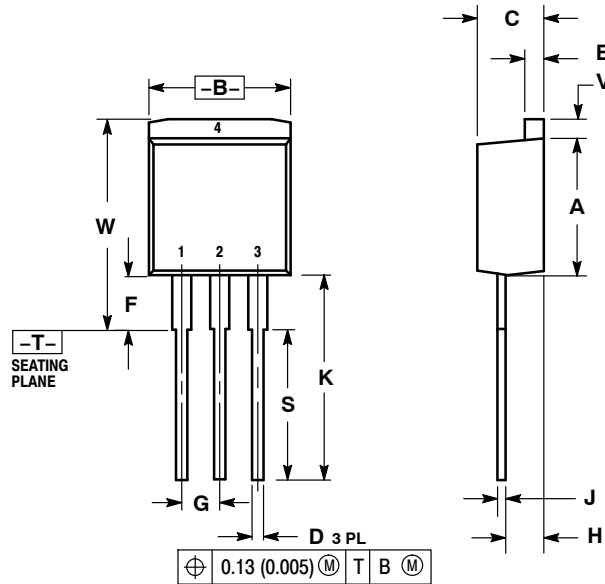

- NOTES:  
1. DIMENSIONING AND TOLERANCING PER ANSI Y14.5M, 1982.  
2. CONTROLLING DIMENSION: INCH.

| DIM | INCHES    |       | MILLIMETERS |       |
|-----|-----------|-------|-------------|-------|
|     | MIN       | MAX   | MIN         | MAX   |
| A   | 0.335     | 0.380 | 8.51        | 9.65  |
| B   | 0.380     | 0.406 | 9.65        | 10.31 |
| C   | 0.160     | 0.185 | 4.06        | 4.70  |
| D   | 0.026     | 0.035 | 0.66        | 0.89  |
| E   | 0.045     | 0.055 | 1.14        | 1.40  |
| F   | 0.122 REF |       | 3.10 REF    |       |
| G   | 0.100 BSC |       | 2.54 BSC    |       |
| H   | 0.094     | 0.110 | 2.39        | 2.79  |
| J   | 0.013     | 0.025 | 0.33        | 0.64  |
| K   | 0.500     | 0.562 | 12.70       | 14.27 |
| S   | 0.390 REF |       | 9.90 REF    |       |
| V   | 0.045     | 0.070 | 1.14        | 1.78  |
| W   | 0.522     | 0.551 | 13.25       | 14.00 |

SWITCHMODE is a trademark of Semiconductor Components Industries, LLC.

ON Semiconductor and are registered trademarks of Semiconductor Components Industries, LLC (SCILLC). SCILLC reserves the right to make changes without further notice to any products herein. SCILLC makes no warranty, representation or guarantee regarding the suitability of its products for any particular purpose, nor does SCILLC assume any liability arising out of the application or use of any product or circuit, and specifically disclaims any and all liability, including without limitation special, consequential or incidental damages. "Typical" parameters which may be provided in SCILLC data sheets and/or specifications can and do vary in different applications and actual performance may vary over time. All operating parameters, including "Typicals" must be validated for each customer application by customer's technical experts. SCILLC does not convey any license under its patent rights nor the rights of others. SCILLC products are not designed, intended, or authorized for use as components in systems intended for surgical implant into the body, or other applications intended to support or sustain life, or for any other application in which the failure of the SCILLC product could create a situation where personal injury or death may occur. Should Buyer purchase or use SCILLC products for any such unintended or unauthorized application, Buyer shall indemnify and hold SCILLC and its officers, employees, subsidiaries, affiliates, and distributors harmless against all claims, costs, damages, and expenses, and reasonable attorney fees arising out of, directly or indirectly, any claim of personal injury or death associated with such unintended or unauthorized use, even if such claim alleges that SCILLC was negligent regarding the design or manufacture of the part. SCILLC is an Equal Opportunity/Affirmative Action Employer. This literature is subject to all applicable copyright laws and is not for resale in any manner.

### PUBLICATION ORDERING INFORMATION

**LITERATURE FULFILLMENT:**  
Literature Distribution Center for ON Semiconductor  
P.O. Box 5163, Denver, Colorado 80217 USA  
**Phone:** 303-675-2175 or 800-344-3860 Toll Free USA/Canada  
**Fax:** 303-675-2176 or 800-344-3867 Toll Free USA/Canada  
**Email:** orderlit@onsemi.com

**N. American Technical Support:** 800-282-9855 Toll Free  
USA/Canada  
**Europe, Middle East and Africa Technical Support:**  
Phone: 421 33 790 2910  
**Japan Customer Focus Center**  
Phone: 81-3-5773-3850

**ON Semiconductor Website:** [www.onsemi.com](http://www.onsemi.com)  
**Order Literature:** <http://www.onsemi.com/orderlit>  
For additional information, please contact your local  
Sales Representative



## Стандарт Электрон Связь

Мы молодая и активно развивающаяся компания в области поставок электронных компонентов. Мы поставляем электронные компоненты отечественного и импортного производства напрямую от производителей и с крупнейших складов мира.

Благодаря сотрудничеству с мировыми поставщиками мы осуществляем комплексные и плановые поставки широчайшего спектра электронных компонентов.

Собственная эффективная логистика и склад в обеспечивает надежную поставку продукции в точно указанные сроки по всей России.

Мы осуществляем техническую поддержку нашим клиентам и предпродажную проверку качества продукции. На все поставляемые продукты мы предоставляем гарантию .

Осуществляем поставки продукции под контролем ВП МО РФ на предприятия военно-промышленного комплекса России , а также работаем в рамках 275 ФЗ с открытием отдельных счетов в уполномоченном банке. Система менеджмента качества компании соответствует требованиям ГОСТ ISO 9001.

Минимальные сроки поставки, гибкие цены, неограниченный ассортимент и индивидуальный подход к клиентам являются основой для выстраивания долгосрочного и эффективного сотрудничества с предприятиями радиоэлектронной промышленности, предприятиями ВПК и научно-исследовательскими институтами России.

С нами вы становитесь еще успешнее!

### Наши контакты:

**Телефон:** +7 812 627 14 35

**Электронная почта:** [sales@st-electron.ru](mailto:sales@st-electron.ru)

**Адрес:** 198099, Санкт-Петербург,  
Промышленная ул, дом № 19, литера Н,  
помещение 100-Н Офис 331