

# IEC and British Standard Fuses

## Section Contents

	Page
<b>Application Data</b> . . . . .	<b>217-218</b>
CSA Type P and Type D fuses (CDS, CDN & PON) . . . . .	.219
Tron® HRC Form II Class C fuses (CGL Form II Class C) . . . . .	.220
HRCI Industrial ceramic body fuses (CIF21 HRCI-CA & CIF06 HRCI-CB) . . . . .	.221
HRCI-J Fast-acting fuses (CJ HRCI-J) . . . . .	.222
HRCI-Miscellaneous Type K fuses (CIH, CIK & CIL HRCI-MISC) . . . . .	.223
HRC Form II current-limiting fuses . . . . .	.224
BS 88 British Standard low voltage fuses (SSD, NSD, ESD & STD, NITD, AAO, BAO, OSD, CEO, DEO BS 88 Part 1) . . . . .	.225
BS 88 British Standard low voltage fuses (AC, AD, BC, BD, CD, DD, ED, EFS & EF, FF, FG, GF, GG, GH BS 88) . . . . .	.226
DIN Style Type D (D16, D27, D33, D125 Type D) . . . . .	.227
Neozed low voltage fuses (NZ01, NZ02 Type D0) . . . . .	.227
NH HRC Fuses . . . . .	<b>228-231</b>
Class gG/gL IEC Industrial ferrule fuses (C08G, C08M, C10G, C10M, C14G, C14M, C22G, C22M) . . . . .	.232
Class aM IEC Industrial ferrule fuses (C08M, C10M, C14M, C22M) . . . . .	.233
Class aM & gG/gL IEC Industrial ferrule fuses with striker (C14G_S, C22G_S, C14M_S, C22M_S) . . . . .	.234
<b>HRC fuse holders</b>	
CAMaster . . . . .	.235
SAFEloc . . . . .	.235

**RED indicates NEW information**



## Application Data

The standard range of fuses for low voltage industrial and general purpose applications meet the requirements of BS 88 and IEC 60269. By using advanced fuse technology, current ratings up to 400A have compact dimensions, but retain standard dimensional and performance requirements. These designs are for 315/240V systems. The standard range of fuses are available from 2-1250A in the following tag forms: Offset Blade - Offset Bolted - Center Bolted.

Supplementary ranges cover applications up to 660Vac and 500Vdc including those with nonstandard tag fixings.

Cooper Bussmann fuses are manufactured under quality systems independently assessed to BS 5750 (ISO 9002) and appropriate ratings carry the ASTA 20 endorsement.

Selecting fuses is relatively simple and effective. The following notes cover the majority of applications. For further information contact our Application Engineers at 636-527-1270.

### Circuit Loading

The current rating of the fuse should not be less than the full load current of the circuit. The circuit should be so designed that small overloads of long duration will not be of frequent occurrence.

### Cable Ratings & Protection

There is an increasing move away from 70°C PVC insulation to materials that are more environmentally friendly, for example 90°C XLPE. The ratings of fusegear, switches, accessories, etc. are generally based upon the equipment being connected to conductors intended to be operated at a temperature not exceeding 70°C in normal service.

In view of the above, it is recommended that the practice of designs based upon conductor temperatures of 70°C be regarded as the norm. The equipment manufacturer should be consulted to ascertain the reduction of nominal current rating of the equipment if conductor temperatures exceeding 70°C are used. In addition, an overriding factor is often voltage drop.

Fuses with gG characteristics protect associated cables against both overload and short-circuit current, provided that the current rating of the fuse 1N is equal or less than the current carrying capacity of the cable 1z.

In motor circuits, the motor starter will provide the overload protection and the fuses will provide the short-circuit protection. The maximum fuse size that can be used depends upon the type of cable used and is determined using the appropriate K factor. The following table gives the maximum sizes of fuses that are recommended for two popular cables with copper conductors, 70°C PVC (K = 115) and 90°C thermosetting (K = 143).

## Application Data for BS Low Voltage Fuses

Cable Size (mm <sup>2</sup> )	Max. Fuse Rating (amps)	
	K = 115	K = 143
1	16	16
1.5	20	25*
2.5	32*	32*
4	50*	50*
6	63*	63*
10	100*	125*
16	125*	160*
25	200*	250*
35	315*	355*
50	400*	500
70	560	630
95	710	800
120	800	1000

\* Extended Motor Circuit dual ratings can be used.

### Protection Against Electrical Shock

For a TN System, a disconnecting time not exceeding 5s is permitted for a distribution circuit. The maximum values of earth fault loop impedance (Zs) of 240V for Cooper Bussmann gG fuses to BS 88: Parts 2 and 6 are:

Rating (A)	Zs (Ohms)	Rating (A)	Zs (Ohms)	Rating (A)	Zs (Ohms)
6	14	50	1.1	250	0.16
10	7.7	63	0.86	315	0.13
16	4.3	80	0.60	400	0.096
20	3.0	100	0.44	500	0.073
25	2.4	125	0.35	630	0.054
32	1.9	160	0.27	800	0.044
40	1.4	200	0.20		

### Ambient Temperature

The derating, in terms of current, of 0.5% per °C above an ambient of 35°C is recommended.

### Interrupting Rating

The standardized interrupting rating values are 80kA for voltages of 415Vac and above, and 40kA for DC applications. The 240Vac designs have an interrupting rating of 50kA.

### Coordination Ratio

All fuses to BS 88 Parts 2 and 6 will give a coordination ratio of 2:1; and for most practical situations a ratio of 1.6:1 (two steps in the R10 series). Example: an upstream fuse rated at 160A will coordinate with a downstream fuse rated at 100A.

### Current and Energy Limitation

The range of fuses have pre-arcing I<sup>2</sup>t values towards the bottom limits of BS 88 Parts 2 and 6. This ensures excellent current and energy limitation. They also have lower power losses at rated current. This assists in the appropriate interchangeability with other makes of fuses.

### Transformers

When fuses are used on the primary side of transformers, the normal fuse current rating should be at least twice the nominal transformer primary current.

### Fluorescent Lighting

The normal fuse current rating should be at least twice the normal full load current of the maximum number of lights to be simultaneously switched.

### Capacitor Circuits

For power factor correction in capacitor circuits, the fuse should be chosen with a current rating greater than 1.5 times the rated capacitor current. This takes into account the high inrush current, circuit harmonics and capacitor tolerances.

### Motor Circuits

In motor circuits, the fuse has to withstand the motor's starting current and often requires a higher rating than the motor's full load current. Coordination recommendations are made by the manufacturers of motor starters in accordance with IEC 60947-4-1. To get Type 2 coordination with fuses, tests are performed with the latest gG or gM fuses to BS 88 or IEC 60269 that have pre-arcing I<sup>2</sup>t values towards the bottom of specified limits. This means that Cooper Bussmann fuses are suitable to provide Type 2 coordination.

Extended dual ratings of motor circuit protection fuses with gM characteristics are available in most popular fuse sizes to extend the use of associated equipment with appropriate economies. In the majority of applications, gG fuses are used. It is not essential to use gM fuses for motor circuit protection, they simply extend the utilization of standard equipment.

Below is a table of recommended fuses at 415V. In most applications, the run-up time is less than 5 seconds and duty is infrequent - no more than twice per hour. The next larger rating should be used for more demanding applications.

Rating Motor	Direct On-line		Asst. Start Standard (gG)
	Standard (gG)	Motor Circuit (gM)	
kW	A	A	A
0.25	0.8	4	-
0.37	1.1	4	-
0.55	1.5	6	-
0.75	2.0	6	-
1.1	3.0	10	-
1.5	3.6	16	-
2.2	5.0	16	-
3.0	6.5	20	-
4.0	8.4	20	-
5.5	11.0	25	20M25
7.5	15.0	40	32M40
11.0	20.0	50	32M50
15.0	27.0	63	32M63
18.5	33.0	80	63M80
22.0	38.0	80	63M80
30.0	54.0	100	63M100
37.0	66.0	125	100M125
45.0	79.0	160	100M160
55.0	98.0	160	100M160
75.0	135.0	250	200M250
90.0	155.0	250	200M250
110.0	185.0	315	200M315
132.0	220.0	355	315M400
150.0	250.0	355	315M400
185.0	310.0	450	400M500
200.0	335.0	500	400M500
225.0	375.0	560	-
250.0	415.0	560	-
280.0	460.0	630	-
335.0	562.0	710	-
355.0	596.0	800	-

## CSA Type P and Type D Fuses

### CDS, CDN & PON Type P & D

#### Specifications

**Description:** CSA time-delay Type D & P fuses.

**Dimensions:** See Catalog Numbers table and Dimensions illustration.

#### Ratings:

Volts: — 250Vac (CDN & PON)  
— 600Vac (CDS)

Amps: — 10-600A

IR: — 10kA minimum

**Agency Information:** CE, CSA Certified to C22.2 No. 59.1.

#### Features and Benefits

- Economical fuse in a variety of ratings for applications not requiring time-delay.

#### Typical Applications

- Lighting, heating and other circuits not subject to temporary surges and where available short-circuit current are relatively low.

#### Basic Catalog Numbers

##### Time-Delay CSA Type "D" Fuses

Catalog Numbers	Volts	Amp Ratings
CDN	250Vac	Below 10A use FRN-R 10, 12, 15, 20, 25, 30, 35, 40, 45, 50, 60, 70, 80, 90, 100
		110, 125, 150, 175, 200, 225, 250, 300, 350, 400, 450, 500, 600
		Below 10A use FRS-R 10, 12, 15, 20, 25, 30, 35, 40, 45, 50, 60
		70, 80, 90, 100, 110, 125, 150, 175, 200, 225, 250, 300, 350, 400, 450, 500, 600
		225, 250, 300, 350, 400, 450, 500, 600
CDS	600Vac	70, 80, 90, 100, 110, 125, 150, 175, 200, 225, 250, 300, 350, 400, 450, 500, 600

##### One-Time CSA Type "P" Fuses

Catalog Number	Volts	Amp Ratings
PON	250Vac	15, 20, 25, 30, 35, 40, 45, 50, 60



#### Dimensions

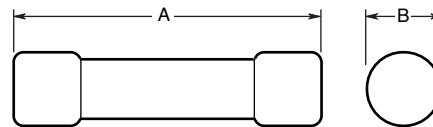

Ferrule Design—1 through 60A

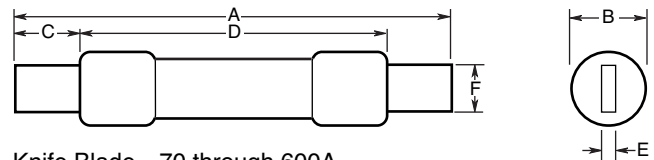

Knife Blade—70 through 600A

IEC & British Fuses

### Catalog Numbers

Basic Catalog Number and Volts	Dimensions in (mm)						
	Amp Ratings	A Overall	B Max Diameter	C Min Blade Length	D Min Barrel Length	E Blade Thickness	F Blade Width
CDN/PON 250Vac	1-30	2.0 (50.8)	0.56 (14.3)	—	—	—	—
	35-60	3.0 (76.2)	0.81 (20.6)	—	—	—	—
	70-100	5.88 (149.4)	—	1.0 (25.4)	—	0.13 (3.2)	0.75 (19.1)
	110-200	7.3 (185.4)	—	1.38 (34.9)	4.13 (104.8)	0.19 (4.8)	1.13 (28.6)
	225-400	8.63 (219.2)	—	1.88 (47.6)	4.63 (117.5)	0.25 (6.4)	1.63 (41.3)
CDS 600Vac	450-600	10.38 (263.7)	—	2.25 (57.2)	5.19 (131.8)	0.25 (6.4)	2 (50.8)
	1-30	5.0 (127.0)	0.81 (20.6)	—	—	—	—
	35-60	5.5 (139.7)	1.06 (27.0)	—	—	—	—
	70-100	7.88 (200.2)	—	1.0 (25.4)	—	0.13 (3.2)	0.75 (19.1)
	110-200	9.63 (244.6)	—	1.38 (34.9)	6.13 (115.6)	0.19 (4.8)	1.13 (28.6)
	225-400	11.63 (295.4)	—	1.88 (47.6)	7.13 (118.1)	0.25 (6.4)	1.63 (41.3)
450-600	13.38 (339.9)	—	2.25 (57.2)	8.19 (208.0)	0.25 (6.4)	2 (50.8)	

#### To Order

To order, specify Basic Catalog Number and amp rating. Example: CDN-30

Data Sheet: 4126

# Tron® HRC Form II Class C Fuses

## CGL Form II Class C

### Specifications

**Description:** Current-limiting HRCII-C fuses designed to withstand inrush currents on typical motor start-ups while offering high current limitation in the short-circuit region.

**Dimensions:** See Dimensions illustrations.

### Ratings:

Volts: — 600Vac/250Vdc (1-30A)

Amps: — 1-600A

IR: — 200kA (40,000A DC)

**Agency Information:** CE, CSA Certified, C22.2 No. 106.

### Features and Benefits

- Close sizing to loads allows using smaller and less costly switches
- Provides a higher degree of short-circuit protection
- Helps protect motors against burnout from overloads

### Typical Applications

- For use in circuits subject to surge currents such as those caused by motors, transformers and other inductive loads

### Catalog Numbers (-Amps)

CGL-1	CGL-40	CGL-175
CGL-2	CGL-45	CGL-200
CGL-3	CGL-50	CGL-225
CGL-4	CGL-60	CGL-250
CGL-6	CGL-70	CGL-300
CGL-10	CGL-80	CGL-350
CGL-15	CGL-90	CGL-400
CGL-20	CGL-100	CGL-450
CGL-25	CGL-110	CGL-500
CGL-30	CGL-125	CGL-600
CGL-35	CGL-150	



### Dimensions

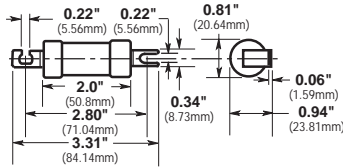

CGL 1-30

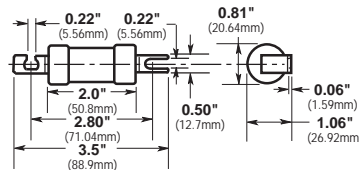

CGL 35-60

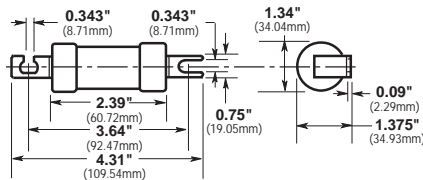

CGL 70-100

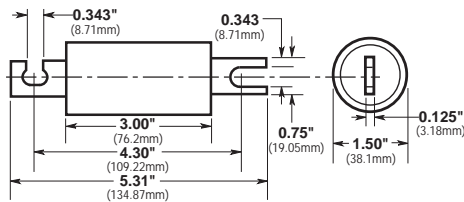

CGL 110-200

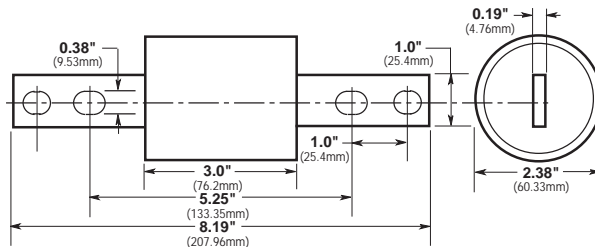

CGL 225-400

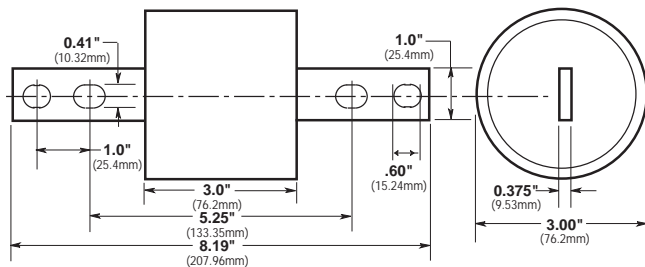

CGL 450-600

## HRCI Industrial Ceramic Body Fuses

### CIF21 HRCI-CA

#### Specifications

**Description:** The HRCI-CA fuse provides both overload and short-circuit protection to HRCI requirements. Offset blades for bolt-on mounting. CIF21 fuse fits the Cooper Bussmann CAMaster fuse holder (see data sheet 4132).

**Dimensions:** See Dimensions illustration.

**Construction:** Ceramic body.

#### Ratings:

Volts: — 600Vac/250Vdc

Amps: — 1-30A

IR: — 200kA RMS Sym.

**Agency Information:** CE, CSA C22.2, No. 106-M92.

**Mounting:** Bolt-on.

#### Catalog Numbers

Catalog Numbers	Amp Ratings
1CIF21	1
3CIF21	3
6CIF21	6
10CIF21	10
15CIF21	15
20CIF21	20
25CIF21	25
30CIF21	30

#### Features and Benefits

- Close sizing to loads allows using smaller and less costly switches
- Provides a higher degree of short-circuit protection
- Helps protect motors against burnout from overloads

#### Typical Applications

- For use in circuits subject to surge currents such as those caused by motors, transformers and other inductive loads

#### Dimensions - in (mm)

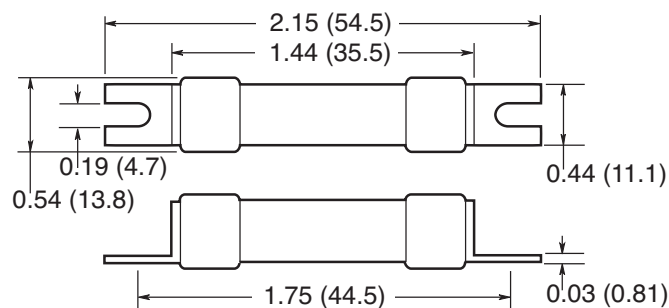

Data Sheet: 4127

### CIF06 HRCI-CB

#### Specifications

**Description:** A miniature industrial fuse that provides both short-circuit and overload protection and the CIF06 fits the 30A SAFEloc fuse holder.

**Dimensions:** See Dimensions illustration.

**Construction:** Ground ceramic body with plated end caps.

#### Ratings:

Volts: — 600Vac/250Vdc

Amps: — 1-30A

IR: — 200kA RMS Sym.

**Agency Information:** CE, CSA C22.2 No. 106-M92 (3-30A only).

**Mounting:** Clip-in offset blades.

#### Catalog Number

Catalog Numbers	Amp Ratings
1CIF06	1
3CIF06	3
6CIF06	6
10CIF06	10
15CIF06	15
20CIF06	20
25CIF06	25
30CIF06	30

#### Features and Benefits

- Close sizing to loads allows using smaller and less costly switches
- Provides a higher degree of short-circuit protection
- Helps protect motors against burnout from overloads

#### Typical Applications

- For use in circuits subject to surge currents such as those caused by motors, transformers and other inductive loads

#### Dimensions - in (mm)



Data Sheet: 4128

# HRCI-J Fast-acting Fuses

## CJ HRCI-J

### Specifications

**Description:** HRCI-J fast-acting fuses are industrial duty fuses with the excellent current-limiting characteristics of fast-acting HRCI-J fuses to limit damage to equipment and installations by the thermal and magnetic energy associated with a large short-circuit fault current. Overload characteristics limit cable damage due to low overload currents.



**Dimensions:** See Catalog Numbers table and Dimensions illustrations.

**Construction:** Ceramic body fuse.

### Ratings:

Volts: — 600Vac (or less), 250Vdc

Amps: — 1-600A

IR: — 200kA

**Agency Information:** CSA C22.2 No. 106 M92; Designed to BS 88:2, IEC 60269-2.

### Dimensions

1CJ to 60CJ

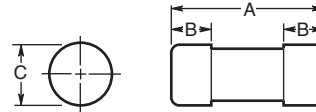

70CJ to 600CJ

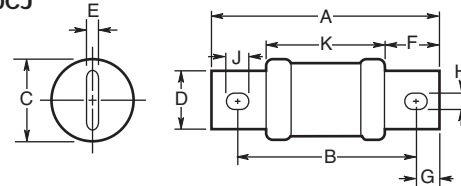

### Catalog Numbers

Catalog Numbers	Amp Ratings	Dimensions in (mm)									
		A	B	C	D	E	F	G	H	J	K
1CJ	1										
3CJ	3										
6CJ	6										
10CJ	10										
15CJ	15	2.25 (57)	0.5 (12.7)	0.81 (20.6)	—	—	—	—	—	—	—
20CJ	20										
25CJ	25										
30CJ	30										
35CJ	35										
40CJ	40										
45CJ	45	2.38 (60)	0.63 (16)	1.06 (27)	—	—	—	—	—	—	—
50CJ	50										
60CJ	60										
70CJ	70										
80CJ	80	4.63 (117)	3.63 (92)	1.13 (28)	0.75 (19)	0.13 (3.2)	1 (25.4)	0.5 (12.7)	0.28 (7.1)	0.38 (9.5)	2.63 (67)
90CJ	90										
100CJ	100										
110CJ	110										
125CJ	125										
150CJ	150	5.75 (146)	4.38 (111)	1.63 (41)	1.13 (28.6)	0.19 (4.8)	1.38 (35)	0.69 (17.5)	0.28 (7.1)	0.38 (9.5)	3 (76)
175CJ	175										
200CJ	200										
225CJ	225										
250CJ	250										
300CJ	300	7.13 (181)	5.25 (133)	2.13 (54)	1.63 (41)	0.25 (6.3)	1.88 (47.6)	0.94 (24)	0.41 (10.3)	0.53 (13.5)	3.38 (86)
350CJ	350										
400CJ	400										
450CJ	450										
500CJ	500	8 (203)	6 (152)	2.63 (66)	2 (51)	0.38 (9.5)	2.13 (54)	1 (25.4)	0.53 (13.5)	0.69 (17.5)	3.75 (96)
600CJ	600										

Data Sheet: 4129



# HRCI - Miscellaneous Type K Fuses

## CIH, CIK & CIL HRCI-MISC

### Specifications

**Description:** HRCI fuses provide both overload and short-circuit protection, featuring offset blades for bolt down mounting.

**Dimensions:** See Catalog Numbers table and Dimensions illustration.

**Construction:** Ceramic body.

### Ratings:

Volts: — 600V

Amps: — 1-100A

IR: — 200kA@600V

**Agency Information:** CE, CSA C22.2 No. 106 M92.



### Dimensions

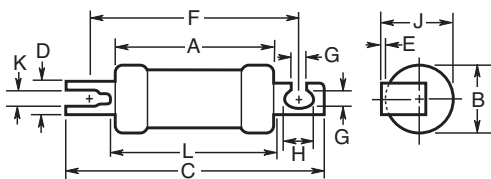

(The CIL14 has a rejection hole, not a slot as shown above.)

IEC &  
British  
Fuses

### Catalog Numbers

Catalog Numbers	Amp Ratings	Dimensions: in (mm)										
		A Max	B Max	C Max	D Nom	E Nom	F Nom	G Nom	H Nom	J Max	K Nom	L Max
1CIH07	1	2.25 (57)	0.94 (24)	3.38 (86)	0.38 (9.2)	0.04 (1.0)	2.88 (73)	0.21 (5.2)	0.31 (8)	1 (25.4)	0.10 (2.6)	2.38 (60)
3CIH07	3											
6CIH07	6											
10CIH07	10											
15CIH07	15											
20CIH07	20											
25CIH07	25											
30CIH07	30	2.28 (58)	1.06 (27)	3.56 (91)	0.5 (12.7)	0.05 (1.2)	2.88 (73)	0.21 (5.2)	0.41 (10.5)	1.09 (28)	0.13 (3.2)	2.38 (61)
35CIK07	35											
40CIK07	40											
50CIK07	50											
60CIK07	60	2.75 (70)	1.44 (37)	4.38 (111)	0.75 (19)	0.09 (2.5)	3.69 (94)	0.34 (8.7)	0.41 (10.5)	1.5 (38.5)	—	2.91 (74)
80CIL14	80											
90CIL14	90											
100CIL14	100											

### Recommended Fuse Holders

Fuse	Fuse Holder
1-30A	CM30CF
35-60A	CM60CF

Data Sheet: 4130

# HRC Form II Current-limiting Fuses

## HRC Form II

### Specifications

**Description:** HRC Form II current-limiting fuses.

**Dimensions:** See Catalog Numbers table and Dimensions illustrations.

**Construction:** Ceramic body.

### Ratings:

Volts: — 600Vac (or less)  
— 250Vdc

Amps: — 2-600A

IR: — 200kA RMS Sym.

**Agency Information:** CE, CSA C22.2 No.106M1992;  
BS 88:2, IEC 60269:2.

### Typical Applications

- Used to protect motor control circuits, together with contactors and overload protection relays to provide Type 2 coordination - per IEC 60947-4.



### Dimensions

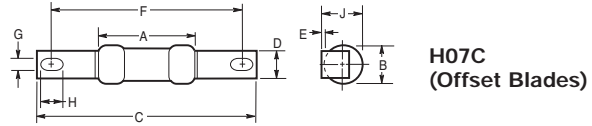

**H07C**  
(Offset Blades)

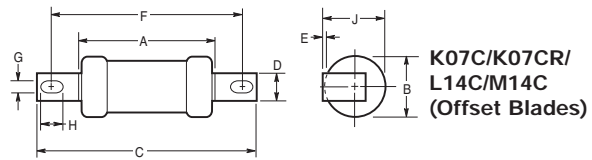

**K07C/K07CR/  
L14C/M14C**  
(Offset Blades)

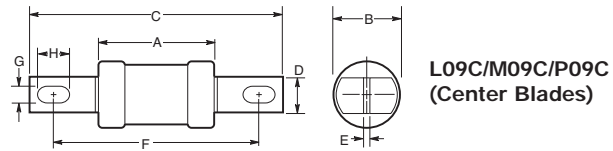

**L09C/M09C/P09C**  
(Center Blades)

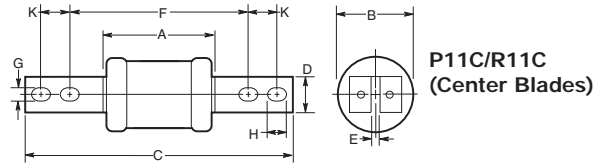

**P11C/R11C**  
(Center Blades)

### Catalog Numbers

Catalog Numbers	Amp Ratings	Dimensions in (mm)										CSA Category											
		A	B	C	D	E	F	G	H	J	K												
2H07C	2	1.38 (35)	0.56 (14)	3.38 (85)	0.38 (9)	0.06 (1.2)	2.88 (73)	0.22 (5.6)	0.31 (8)	0.56 (14)	—	HRCII-C											
4H07C	4																						
6H07C	6																						
10H07C	10																						
15H07C	15																						
20H07C	20																						
25H07C	25																						
30H07C	30																						
40K07C	40												2.19 (56)	0.88 (22)	3.44 (87)	0.5 (13)	0.13 (3.2)	3.69 (94)	0.34 (8.7)	0.88 (22)	—	HRCII-C	
50K07C	50																						
60K07C	60																						
80K07CR	80	2.38 (60)	0.88 (21.4)	4.38 (111)	0.56 (14.3)	0.09 (2.4)	4.38 (111)	0.56 (14)	—	—	HRCII-C												
100K07CR	100																						
80L14C	80	2.56 (65)	1.5 (38)	5.38 (136)	0.75 (19)	0.13 (3.2)	5.25 (133)	0.41 (10)	0.63 (16)	1 (25.4)	—	HRCII-C											
100L14C	100																						
125M14C	125																						
150M14C	150																						
200M14C	200																						
80L09C	80												2.38 (60)	0.88 (21.4)	5.38 (136)	0.56 (14)	0.13 (3.2)	5.25 (133)	0.41 (10)	0.63 (16)	1 (25.4)	—	HRCII-C
100L09C	100																						
125M09C	125																						
150M09C	150																						
200M09C	200																						
250P09C	250	3.06 (178)	2.31 (59)	8.25 (210)	1 (25.4)	0.19 (5)	5.25 (133)	0.41 (10)	0.63 (16)	—	1 (25)	HRCII-C											
300P09C	300																						
350P09C	350																						
400P09C	400																						
250P11C	250																						
300P11C	300	3.19 (81)	2.88 (73)	8.25 (210)	1 (25.4)	0.19 (5)	5.25 (133)	0.41 (10)	0.63 (16)	—	1 (25)	HRCII-C											
350P11C	350																						
400P11C	400																						
450R11C	450																						
500R11C	500																						
600R11C	600																						



## BS 88 British Standard Low Voltage Fuses

### SSD, NSD, ESD BS 88 Part 1

#### Specifications

**Description:** The NSD and ESD are low voltage fuses complying with general purpose gG characteristics.

**Construction:** Ceramic body.

#### Ratings:

Volts: — 240-550Vac (See Catalog Numbers table)

Amps: — 2-63A (See Catalog Numbers table)

— 20M25-63M100A Motor Starter ratings  
(See Catalog Numbers table)

IR: — 33kA (SSD)

— 80kA (NSD, ESD)

**Agency Information:** CE, Meets the requirements of BS 88 Part 1 and IEC 60269-1.

**Mounting:** Offset blades.

#### Basic Catalog Numbers

Basic Catalog Numbers	Amp Ratings	Max AC Voltage Ratings	BS 88 Ref.
SSD	2, 4, 6, 10, 16, 20, 25, 32	240	E1
NSD	2, 4, 6, 10, 16, 20, 25, 32,	550	F1
	20M25*, 20M32*, 20M36*, 32M36*, 32M40*,	415	F1
	32M50*, 32M63*	415	F1
ESD	2, 4, 6, 10, 16, 25, 32	550	F2
	40, 50, 63, 63M80, 63M100*	415	F2

\*"M" indicates motor starter ratings.

#### To Order

To order, specify Basic Catalog Number and amp rating. Example: SSD-20

#### Recommended Fuse Holders

Basic Fuse Catalog Numbers	Holder Catalog Numbers
NSD	32NNSF
ESD	63ENSF



### STD, NITD, AAO, BAO, OSD, CEO, DEO BS 88 Part 1

#### Specifications

**Description:** The STD to DEO types are low voltage fuses complying with general purpose gG characteristics.

**Construction:** Ceramic body.

#### Ratings:

Volts: — 240-550Vac (See Catalog Numbers table)

Amps: — 2-200A (See Catalog Numbers table)

— 20M25-200M315A Motor Starter ratings  
(See Catalog Numbers table)

IR: — 33kA (STD)

— 80kA (NITD, AAO, BAO, CEO, DEO)

**Agency Information:** CE, Meets the requirements of BS 88 Part 1 and IEC 60269-1.

**Mounting:** Offset bolted blades.

#### Typical Applications

- The STD type are used in 240V street lighting cut-outs.
- NITD to DEO types used for industrial and general purpose applications

#### Basic Catalog Numbers

Basic Catalog Numbers	Amp Ratings	Max AC Voltage Ratings	BS 88 Ref.
STD	2, 4, 6, 10, 16, 20, 25, 32	240	—
NITD	2, 4, 6, 10, 16, 20, 25, 32	550	—
	20M25*, 20M32*, 32M40*, 32M50*, 32M63*	415	—
AAO	2, 4, 6, 10, 16, 20, 25, 32, 32M40*, 32M50*, 32M63*	550	—
BAO	40, 50, 63, 63M80*, 63M100*	550	A3
CEO	32, 40, 50, 63, 80, 100	550	A4
	100M125*, 100M160*, 100M200*	415	A4
DEO	125, 160, 200, 200M250*, 200M315*	415	—
OSD	80, 100	550	—
	100M125*, 100M160*	415	—

\*"M" indicates motor starter ratings.

#### To Order

To order, specify Basic Catalog Number and amp rating. Example: BAO-16

#### Recommended Fuse Blocks & Holders

Basic Fuse Catalog Numbers	Block/Holder Catalog Numbers
NITD	CM32FC
AAO	CM32F
BAO	CM63F
OSD	CM100F
CEO	BH-0111

Data Sheets 4123 (STD), 4106 (NITD), 4109 (AAO), 4112 (BAO), 4107 (OSD), 4115 (CEO) and 4117 (DEO)

Data Sheets 4105 (SSD), 4100 (NSD) and 4101 (ESD)

# BS 88 British Standard Low Voltage Fuses

## AC, AD, BC, BD, CD, DD, ED, EFS BS 88

### Specifications

**Description:** Low voltage fuses that comply with general purpose gG characteristics and available up to 400A with two hole mount and up to 1250A with four hole mount.

**Construction:** Ceramic body.

### Ratings:

Volts: — 415/550Vac, 250Vdc (See Catalog Numbers table)

Amps: — 2-400A (See Catalog Numbers table)  
 — 63M80-400M500A Motor Starter ratings (See Catalog Numbers table)

IR: — See Catalog Numbers table

**Agency Information:** CE, Meets the requirements of BS 88 Parts 1 and 2 and IEC 60269-1.

**Mounting:** Center bolted blades, two-hole mount.



### Basic Catalog Numbers

Basic Catalog Numbers	Amp Ratings	Interrupting Ratings		Max Voltage Ratings		BS 88 Ref.
		AC	DC	AC	DC	
AC	2, 4, 6, 10, 16, 20, 25, 32	80kA	40kA	550	250	—
AD	2, 4, 6, 10, 16, 20, 25, 32	80kA	40kA	550	250	—
BC	40, 50, 63 63M80*, 63M100*	80kA	40kA	550	250	—
BD	40, 50, 63	80kA	—	550	—	—
CD	40, 50, 63	80kA	40kA	550	250	—
DD	80, 100, 100M125*, 100M160*, 100M200*, 100M200*	80kA	—	415	—	B1
ED	125, 160, 200, 200M250*, 200M315*	80kA	—	415	—	B2
EFS	250, 315, 355, 400, 315M400*, 400M500*	80kA	—	415	—	B3 B4
EFS	125, 160, 200, 250, 315	80kA	—	415	—	—

\*"M" indicates motor starter ratings.

### To Order

To order, specify Basic Catalog Number and amp rating. Example: BC-40

### Recommended Fuse Blocks & Holder

Basic Fuse Catalog Numbers	Block/Holder Catalog Numbers
AC	BH-0111 Modular fuse block
AD	200DF Fuse holder
BC	BH-0111 Modular fuse block
BD	200DF Fuse holder
CD	200DF Fuse holder
DD	200DF Fuse holder
ED	BH-1131 Modular fuse block

Data Sheets 4110 (AC), 4111 (AD), 4113 (BC), 4114 (BD), 4116 (CD), 4118 (DD), 4119 (ED) and 4121 (EFS)

## EF, FF, FG, GF, GG, GH BS 88

### Specifications

**Description:** Low voltage fuses complying with general purpose gG characteristics and available up to 400A with two hole mount and up to 1250A with four hole mount.

**Construction:** Ceramic body.

### Ratings:

Volts: — 415/550Vac, 250/400Vdc (See Catalog Numbers table for details)

Amps: — 355-1250

IR: — See Catalog Numbers table

**Agency Information:** CE, Meets the requirements of BS 88 Parts 1 and 2 and IEC269-1.

**Mounting:** Center bolted blades, four-hole mount.



### Basic Catalog Numbers

Basic Catalog Numbers	Amp Ratings	Interrupting Ratings		Max Voltage Ratings		BS 88 Ref.
		AC	DC	AC	DC	
EF	355, 400 400M500*	80kA	—	415	—	C1
FF	450, 500, 560, 630	80kA	40kA	550	400	C2
FG	450, 500, 560, 630	80kA	40kA	550	400	—
GF	710, 800	80kA	40kA	550	250	C3
GG	710, 800 1000, 1250	80kA	40kA	550	250	—
GH	710, 800, 1000, 1250	80kA	—	550	—	—

\*"M" indicates motor starter ratings. \*"M" indicates motor starter ratings.

### To Order

To order, specify Basic Catalog Number and amp rating. Example: FG-450

Data Sheets 4120 (EF), 4102 (FF), 4122 (FG), 4103 (GF), 4104 (GG) and 4108 (GH)

# DIN Style Type D and Neozed Low Voltage Fuses

## D16, D27, D33, D125 Type D

**Specifications**

**Description:** DIN style Type D low voltage fuses.

**Dimensions:** See Catalog Numbers table and Dimensions illustrations.

**Construction:** Ceramic body.

**Ratings:**

Volts: — 500Vac

Amps: — 2-100A

IR: — 100kA

**Agency Information:** CE, "D" type fuses complying with DIN 49360 Part 2 and DIN 49515, operating class gL.

**Catalog Numbers**

Catalog Numbers	Amp Ratings	Dimension "D" (mm)	Color Code	Figure Number
2D16	2	6	Pink	1
4D16	4	6	Brown	
6D16	6	6	Green	
10D16	10	8	Red	
16D16	16	10	Grey	
20D16	20	12	Blue	
25D16	25	14	Yellow	
2D27	2	6	Pink	2
4D27	4	6	Brown	
6D27	6	6	Green	
10D27	10	8	Red	
16D27	16	10	Grey	
20D27	20	12	Blue	
25D27	25	14	Yellow	
35D33	35	16	Black	3
50D33	50	18	White	
63D33	63	20	Copper	
80D125	80	5	Silver	4
100D125	100	7	Red	

Additional Fuselinks: Quick acting fuselinks in body sized D16, D27, D33 and D125 rated 2-100A. Reference number suffixed Q, i.e. 10D27Q. Voltage rating 500V. Gauge rings and keys can also be supplied.

**Dimensions (mm)**

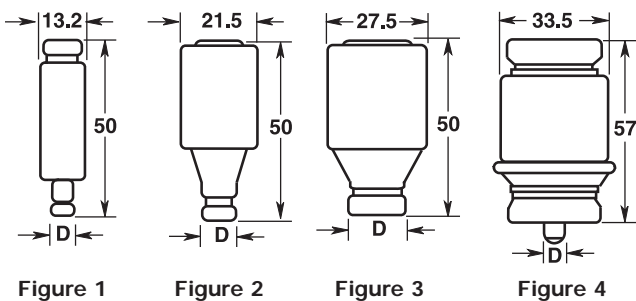

## NZ01, NZ02 Type D0

**Specifications**

**Description:** Low voltage Neozed fuses suitable for use on 250Vdc systems.

**Dimensions:** See Catalog Numbers table and Dimensions illustration.

**Construction:** Ceramic body.

**Ratings:**

Volts: — 400Vac

Amps: — 2-63A

IR: — 100kA

**Agency Information:** CE

**Catalog Numbers**

Catalog Numbers	Amp Ratings	Dimension "D" (mm)	Color Code
2NZ01	2	11	Pink
4NZ01	4	11	Brown
6NZ01	6	11	Green
10NZ01	10	11	Red
16NZ01	16	11	Grey
20NZ02	20	15	Blue
25NZ02	25	15	Yellow
35NZ02	35	15	Black
50NZ02	50	15	White
63NZ02	63	15	Copper

**Dimensions (mm)**

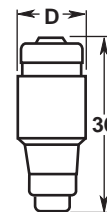

IEC & British Fuses

# NH HRC Fuses

## \_\_NHG\_\_B

**Specifications**

**Class:** gG/gL

**Description:** DIN square bodied, dual indication industrial fuses.

**Construction:** Steatite insulator, corrosion-proof (aluminum) metal parts with full-contact, silver-plated copper blades.

**Sizes:** DIN 000 to 4.

**Selectivity Ratio:** 1:1.6 up to 500Vac.



**Ratings:**

Volts: — 500Vac/250Vdc

— 690Vac/250Vdc

Amps: — 2-1250A

IR: — 120kA

Frequency: — 50Hz

Operating Frequency: — 45-62Hz

**Agency Information:** IEC 60269, VDE0636, DIN 43620 Part 1 to 4, VDE Mark and CE.

Fuse Blocks	Size
SB00-D	000-00
SB1-D	1*, 1
SB2-D	02, 2, 03, 3

**Dimensions (mm)**

Fuse Size	a <sup>1</sup>	a <sup>2</sup> (max)	a <sup>3</sup>	a <sup>4</sup>	b (nom)	c <sup>1</sup> (± 8)	c <sup>2</sup> (nom)	D (nom)	e <sup>1</sup> (max)	e <sup>2</sup> (max)	e <sup>3</sup> (max)	e <sup>4</sup> (nom)	f (max)
000	78.5 ± 1.5	54	45 ± 1.5	49 ± 1.5	15	35	10	2 ± 0.5	41	21	16	6	8
00	78.5 ± 1.5	54	45 ± 1.5	49 ± 1.5	15	35	11	7.0 ± 0.5	48	30	25	6	15
0	125 ± 2.5	68	62 +3/-1.5	68 +1.5/-3	15	35	11	2.5 ± 0.5	48	30	25	6	15
01	135 ± 2.5	75	62 ± 2.5	68 ± 2.5	15	40	11	2.5 ± 0.5	48	30	25	6	15
1	135 ± 2.5	75	62 ± 2.5	68 ± 2.5	20	40	11	2.5 ± 0.5	53	52	25	6	15
02	150 ± 2.5	75	62 ± 2.5	68 ± 2.5	20	48	11	2.5 ± 0.5	53	52	25	6	15
2	150 ± 2.5	75	62 ± 2.5	68 ± 2.5	25	48	11	2.5 ± 0.5	61	60	25	6	15
03	150 ± 3	75	62 ± 2.5	68 ± 2.5	25	60	11	2.5 ± 0.5	61	60	25	6	15
3	150 ± 3	75	62 ± 2.5	68 ± 2.5	32	60	11	3.0 ± 0.5	75	70	25	6	18
4	200	84	80	90	50	85	11	3	120	87	—	8	30

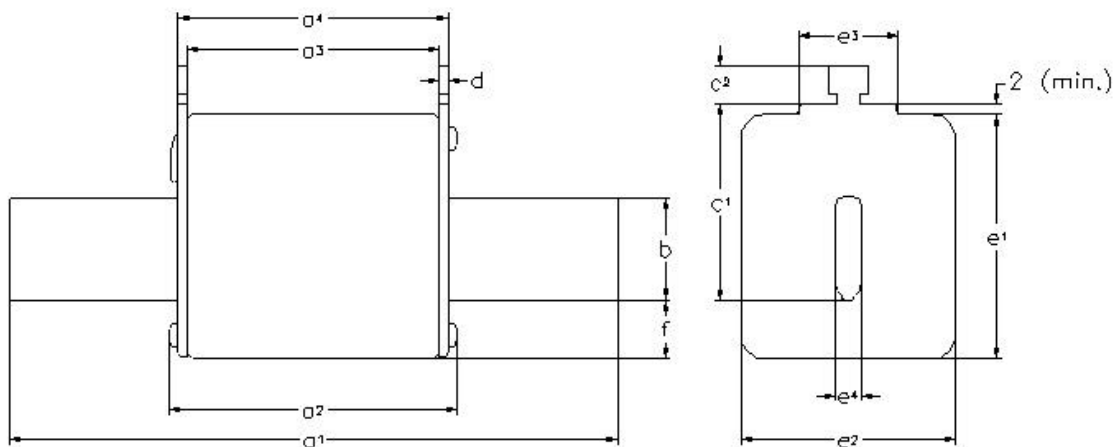

## NH HRC Fuses

500Vac / 250Vdc	Size	Rated Current (Amps)	gG/gL Dual Indicator Voltage Conducting Metal Gripping Lugs	Carton Quantity
		2	2NHG00B	3
		4	4NHG00B	3
		6	6NHG00B	3
		10	10NHG00B	3
		16	16NHG00B	3
		20	20NHG00B	3
	000	25	25NHG00B	3
		32	32NHG00B	3
		35	35NHG00B	3
		40	40NHG00B	3
		50	50NHG00B	3
		63	63NHG00B	3
		80	80NHG00B	3
		100	100NHG00B	3
	00	125	125NHG00B	3
		160	160NHG00B	3
		10	10NHGOB	3
		16	16NHGOB	3
		20	20NHGOB	3
		25	25NHGOB	3
		32	32NHGOB	3
	0	35	35NHGOB	3
		40	40NHGOB	3
		50	50NHGOB	3
		63	63NHGOB	3
		80	80NHGOB	3
		100	100NHGOB	3
		125	125NHGOB	3
		160	160NHGOB	3
		10	10NHG01B	3
		16	16NHG01B	3
		20	20NHG01B	3
		25	25NHG01B	3
		32	32NHG01B	3
	01	35	35NHG01B	3
		40	40NHG01B	3
		50	50NHG01B	3
		63	63NHG01B	3
		80	80NHG01B	3
		100	100NHG01B	3
		125	125NHG01B	3
		160	160NHG01B	3
	1	200	200NHG1B	3
		224	224NHG1B	3
		250	250NHG1B	3
		35	35NHG02B	3
		40	40NHG02B	3
		50	50NHG02B	3
		63	63NHG02B	3
	02	80	80NHG02B	3
		100	100NHG02B	3
		125	125NHG02B	3
		160	160NHG02B	3
		200	200NHG02B	3
		224	224NHG02B	3
		250	250NHG02B	3
	2	315	315NHG2B	3
		355	355NHG2B	3
		400	400NHG2B	3
		250	250NHG03B	3
		315	315NHG03B	3
	03	355	355NHG03B	3
		400	400NHG03B	3
	3	500	500NHG3B	3
		630	630NHG3B	3
		500	500NHG4G	1
	4	630	630NHG4G	1
	Single Indicator	800	800NHG4G	1
	Slotted End	1000	1000NHG4G	1
	Tags	1250	1250NHG4G	1



## NH HRC Fuses

690Vac / 250Vdc	Size	Rated Current (Amps)	gG/gL Dual Indicator Voltage Conducting Metal Gripping Lugs	Carton Quantity		
	000	2	2NHG000B-690	3		
		4	4NHG000B-690	3		
		6	6NHG000B-690	3		
		10	10NHG000B-690	3		
		16	16NHG000B-690	3		
		20	20NHG000B-690	3		
		25	25NHG000B-690	3		
		32	32NHG000B-690	3		
		35	35NHG000B-690	3		
		40	40NHG000B-690	3		
	00	50	50NHG00B-690	3		
		63	63NHG00B-690	3		
		80	80NHG00B-690	3		
		100	100NHG00B-690	3		
			0	6	6NHGOB-690	3
				10	10NHGOB-690	3
				16	16NHGOB-690	3
				20	20NHGOB-690	3
				25	25NHGOB-690	3
				32	32NHGOB-690	3
35	35NHGOB-690			3		
40	40NHGOB-690			3		
50	50NHGOB-690			3		
63	63NHGOB-690			3		
	1	80	80NHGOB-690	3		
		100	100NHGOB-690	3		
		50	50NHG1B-690	3		
		63	63NHG1B-690	3		
		80	80NHG1B-690	3		
		100	100NHG1B-690	3		
		125	125NHG1B-690	3		
		160	160NHG1B-690	3		
		200	200NHG1B-690	3		
			2	63	63NHG2B-690	3
80	80NHG2B-690			3		
100	100NHG2B-690			3		
125	125NHG2B-690			3		
160	160NHG2B-690			3		
200	200NHG2B-690			3		
224	224NHG2B-690			3		
250	250NHG2B-690			3		
315	315NHG2B-690			3		
	3			250	250NHG3B-690	3
		315	315NHG3B-690	3		
		355	355NHG3B-690	3		
		400	400NHG3B-690	3		
		425	425NHG3B-690	3		
		500	500NHG3B-690	3		



## NH Fuse Bases

### SB\*-D, SB\*-S

Up to 690V / 160 - 1250A

Sizes 00, 0, 1, 2, 3, 4



**Description:** NH fuse bases with thermoplastic bodies. DIN rail and screw mounting (size 4 screw fix). Range of protection accessories for live parts in order to obtain IP20 protection standard.

#### Ratings:

- Voltage: up to 690Vac
- Amps: 2 to 1250A

**Applications:** Protection of industrial circuits and electrical apparatus

**Standards and Approvals:** IEC 60269, DIN 43620

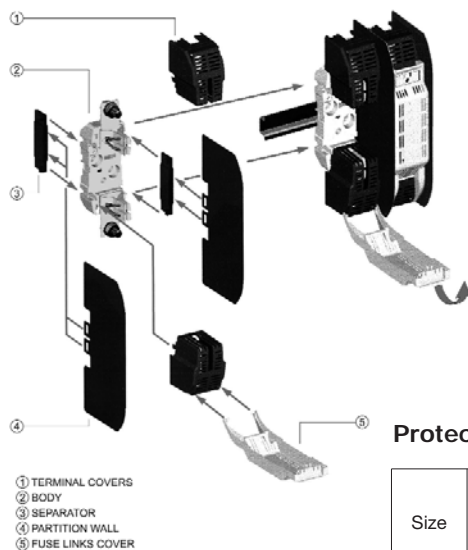

#### Part Numbers

Size	Poles	Current (Amps)	Part Numbers	Carton Quantity	Compatible Fuse Size
			DIN Screw		
00	1 3	160A	SB00-D	3	000 & 00
			TB00-D TB00-D-IP20		
0	1 3	160A	SB0-D	3	0
			TB0-D		
1	1 3	250A	SB1-D	3	01 & 1
			TB1-D		
2	1 3	400A	SB2-D	3	02 & 2
			TB2-D		
3	1 3	630A	SB3-D	3	03 & 3
			TB3-D		
4	1	1250A	SB4-S (Screw Connection only)	3	4

#### Neutral

Size	Current (Amps)	Part Ref	Carton Quantity
NH00	160	SL00	3
NH0	160	SL0	
NH1	250	SL1	
NH2	400	SL2	
NH3	630	SL3	
NH4	1000	SL4	



#### Fuse extraction handle

Size	Part Ref	Carton Quantity
C00-3	FEH	1



#### Protection accessories

Size	Current (Amps)	Separation Partition ④		Fuse Casing ⑤		Terminal Cover ①		Separator ③	
		Part Ref	Carton Quantity	Part Ref	Carton Quantity	Part Ref	Carton Quantity	Part Ref	Carton Quantity
NH00*	160A	SP00*	2	FC00*	3	CS00*	6	BC00*	2
NH0	160A	SP0	2	FC0	3	CS0	6	BC0	2
NH1	250A	SP1-2	2	FC1-2	3	CS1	6	BC1-2	2
NH2	400A	SP1-2	2	FC1-2	3	CS2	6	BC1-2	2
NH3	630A	SP3	2	FC3	3	CS3	6	BC3	2

\* For single pole only

#### IP Protection Kits

Part Reference	Description
TB00-D-IP20	Complete triple pole fuse base IP20 rated
FPK0-3P	IP20 kit for TB0-D fuse base
FPK1-3P	IP20 kit for TB1-D fuse base
FPK2-3P	IP20 kit for TB2-D fuse base
FPK3-3P	IP20 kit for TB3-D fuse base

#### Microswitch

Part Ref	Carton Quantity
BVL-50	1



Microswitch suitable for the following NH Fuse links:

- 400 Volts gG/gL
- 500 Volts gG/gL and aM
- 690 Volts gG/gL and aM

## Class gG/gL IEC 60269 Industrial Ferrule Fuses

8 x 31mm: 400Vac, 0.5 - 25A

Catalog Number	Rated Amps	Rated Voltage	Dimensions (mm)		
			A	B	C
C08G0-5	0.5	400Vac	8.5	31.5	6.3
C08G1	1				
C08G2	2				
C08G4	4				
C08G6	6				
C08G8	8				
C08G10	10				
C08G12	12				
C08G16	16				
C08G20	20				
C08G25	25				

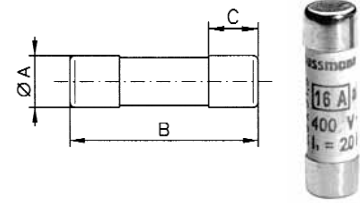

10 x 38mm: 500Vac, 0.5 - 32A

Catalog Number	Rated Amps	Rated Voltage	Dimensions (mm)		
			A	B	C
C10G0-5	0.5	500Vac	10.3	38	10
C10G1	1				
C10G2	2				
C10G4	4				
C10G6	6				
C10G8	8				
C10G10	10				
C10G12	12				
C10G16	16				
C10G20	20				
C10G25	25				
C10G32	32				
C10G32	32				

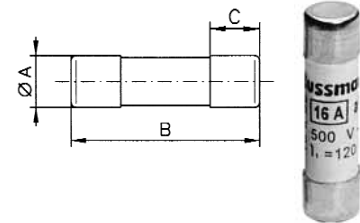

14 x 51mm: 400Vac - 500Vac - 690Vac, 1 - 50A

Catalog Number	Rated Amps	Rated Voltage	Dimensions (mm)				
			A	B	C	D	E
C14G1	1	690Vac	14.3	51	13	8	4
C14G2	2						
C14G4	4						
C14G6	6						
C14G8	8						
C14G10	10						
C14G12	12						
C14G16	16						
C14G20	20						
C14G25	25						
C14G32	32						
C14G40	40						
C14G50	50						
C14G50	50	500Vac					
C14G50	50	400Vac					

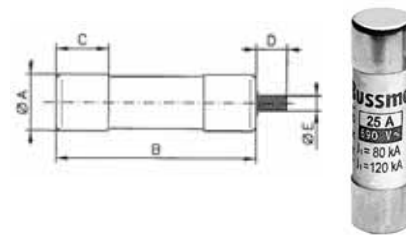

22 x 58mm: 400Vac - 500Vac - 690Vac, 2 - 125A

Catalog Number	Rated Amps	Rated Voltage	Dimensions (mm)				
			A	B	C	D	E
C22G2	2	690Vac	22.2	58	16	8	4
C22G4	4						
C22G6	6						
C22G8	8						
C22G10	10						
C22G12	12						
C22G16	16						
C22G20	20						
C22G25	25						
C22G32	32						
C22G40	40						
C22G50	50						
C22G63	63						
C22G80	80						
C22G100	100						
C22G125	125						
C22G125	125	500Vac					
C22G125	125	400Vac					

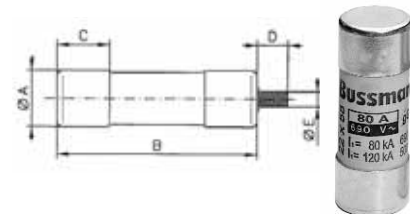

## Class aM IEC Industrial Ferrule Fuses - Class aM IEC 60269

8 x 31mm: 400Vac, 1 - 8A

Catalog Number	Rated Amps	Rated Voltage	Dimensions (mm)		
			A	B	C
C08M1	1	400Vac	8.5	31.5	6.3
C08M2	2				
C08M4	4				
C08M6	6				
C08M8	8				

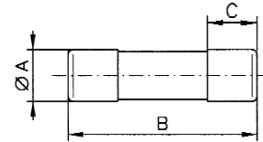

10 x 38mm: 400Vac - 550Vac, 0.16 - 25A

Catalog Number	Rated Amps	Rated Voltage	Dimensions (mm)		
			A	B	C
C10M0-16	0.16	550Vac	10.3	38.0	10.0
C10M0-25	0.25				
C10M0-5	0.5				
C10M1	1				
C10M2	2				
C10M4	4				
C10M6	6				
C10M8	8				
C10M10	10				
C10M12	12				
C10M16	16				
C10M20	20				
C10M25	25				

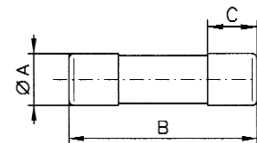

14 x 51mm: 690Vac - 500Vac, 0.25 - 50A

Catalog Number	Rated Amps	Rated Voltage	Dimensions (mm)		
			A	B	C
C14M0-25	0.25	690Vac	14.3	51	13
C14M1	1				
C14M2	2				
C14M4	4				
C14M6	6				
C14M8	8				
C14M10	10				
C14M12	12				
C14M16	16				
C14M20	20				
C14M25	25				
C14M32	32				
C14M40	40				
C14M50	50				

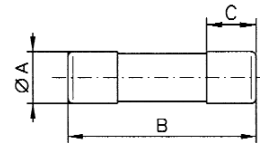

22 x 58mm: 400Vac - 500Vac - 690Vac, 2 - 125A

Catalog Number	Rated Amps	Rated Voltage	Dimensions (mm)		
			A	B	C
C22M2	2	690Vac	22.2	58	16
C22M4	4				
C22M6	6				
C22M8	8				
C22M10	10				
C22M12	12				
C22M16	16				
C22M20	20				
C22M25	25				
C22M32	32				
C22M40	40				
C22M50	50				
C22M63	63				
C22M80	80				
C22M100	100	500Vac			
C22M125	125	400Vac			

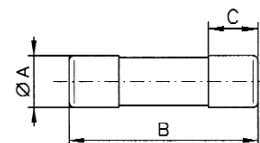

Neutral Links

Catalog Number	Product Class
C8NL	QR
C10NL	
C14NL	
C22NL	

IEC & British Fuses

# Class aM & gG/gL IEC Industrial Ferrule Fuses with Striker

14 X 51



## Class gG/gL with Striker

Catalog Number With Striker	Amp Rating	Watts Loss (W)	Voltage (AC)	Interrupting Rating (kA)
C14G2S	2	0.24	500	120
C14G4S	4	0.45		
C14G6S	6	0.42		
C14G8S	8	0.70		
C14G10S	10	0.53		
C14G12S	12	0.88		
C14G16S	16	1.16		
C14G20S	20	1.23		
C14G25S	25	1.46		
C14G32S	32	2.04		
C14G40S	40	3.34		
C14G50S	50	3.04		

22 X 58



Catalog Number With Striker	Amp Rating	Watts Loss (W)	Voltage (AC)	Interrupting Rating (kA)
C22G4S	4	0.48	690	80
C22G6S	6	0.47		
C22G8S	8	0.73		
C22G10S	10	0.74		
C22G12S	12	0.83		
C22G16S	16	1.21		
C22G20S	20	1.29		
C22G25S	25	1.53		
C22G32S	32	2.13		
C22G40S	40	3.40		
C22G50S	50	3.48		
C22G63S	63	4.46		
C22G80S	80	5.86		
C22G100S	100	6.61	500	120
C22G125S	125	8.42	400	

14 X 51



## Class aM with Striker

Catalog Number With Striker	Amp Rating	Watts Loss (W)	Voltage (AC)	Interrupting Rating (kA)
C14M1S	1	0.14	500	120
C14M2S	2	0.24		
C14M4S	4	0.45		
C14M6S	6	0.42		
C14M8S	8	0.70		
C14M10S	10	0.53		
C14M12S	12	0.88		
C14M16S	16	1.16		
C14M20S	20	1.23		
C14M25S	25	1.46		
C14M32S	32	2.04		
C14M40S	40	3.34		
C14M50S	50	3.04		

22 X 58



Catalog Number With Striker	Amp Rating	Watts Loss (W)	Voltage (AC)	Interrupting Rating (kA)
C22M2S	2	0.29	690	80
C22M4S	4	0.48		
C22M6S	6	0.47		
C22M8S	8	0.73		
C22M10S	10	0.74		
C22M12S	12	0.83		
C22M16S	16	1.21		
C22M20S	20	1.29		
C22M25S	25	1.53		
C22M32S	32	2.13		
C22M40S	40	3.40		
C22M50S	50	3.48		
C22M63S	63	4.46		
C22M80S	80	5.86		
C22M100S	100	6.61		
C22M125S	125	8.42	400	

## HRC Fuse Holders

### CAMaster

#### Specifications Catalog Symbol:

See table below.

**Description:** The CAMaster HRC fuse holder features a unique cam-action for easy fuse removal while allowing significantly improved contact pressure between fuse carrier and base contact that enhances electrical performance. A range of lockable safety carriers for the fuse holder (catalog reference: LSC), are available.

#### Ratings:

Volts: — 690V

Amps: — 30-100A (See Catalog Number table for details)

**Agency Information:** CE, CSA C22.2 No. 39; IEC 269 AND BS 88.

**Mounting:** 35mm DIN-rail or single screw mounting.

#### Catalog Numbers

Catalog Numbers	Amp Ratings	Details For:	Fuse Accepted
CM20CF	30	HRCI-CA Applications	_CIF21
CM30CF	30		_H07C
CM60CF	60	HRCII Applications	_K07C
CM100CF	100		_K07CR

#### Accessory Catalog Numbers for CAMaster Units

Catalog Numbers	Amp Ratings	Details	Fuse Holder Accepted
20BS	30	Back Stud	CM20CF
32BS	30		CM30CF
60/100BS	60/100		CM60/100CF
GLP	All	Ganging Link Kit	3-Pole
NI	All	660V Neon Indicator	—
20LSC	30	Security Carrier with Clip	CM20CF
30LSC	30		CM30CF
60/100LSC	60/100A		CM60/100CF



### SAFEloc

#### Specifications Catalog Symbol:

See table below.

**Description:** The SAFEloc HRC fuse holders (for use with HRCI-CB fuses) provides a positive, stress-free fuse fitting and locks it in position to ensure safe insertion and withdrawal from the base. Base contacts are fully shrouded to help protect against electric shock. Shrouds utilize simple slide/snap action allowing access to the contact terminal screws.

#### Ratings:

Volts: — 600V

Amps: — 30-60A (See Catalog Number table for details)

**Agency Information:** CE, Designed to accommodate the compact range of offset blade fuse to CSA C22.2 No. 106, HRCI-CB.

**Mounting:** 35mm DIN rail or single screw mounting.

#### Catalog Numbers\*

Catalog Numbers	Amp Ratings	Connection	Fuse Accepted
C30F	30	Front	_CIF06
C30BS		Back	
C30FBS		Front-Back	
C60F	60	Front	EK-Amp
C60BS		Back	
C60FBS		Front-Back	

\*For use with HRCI-CB Fuses.





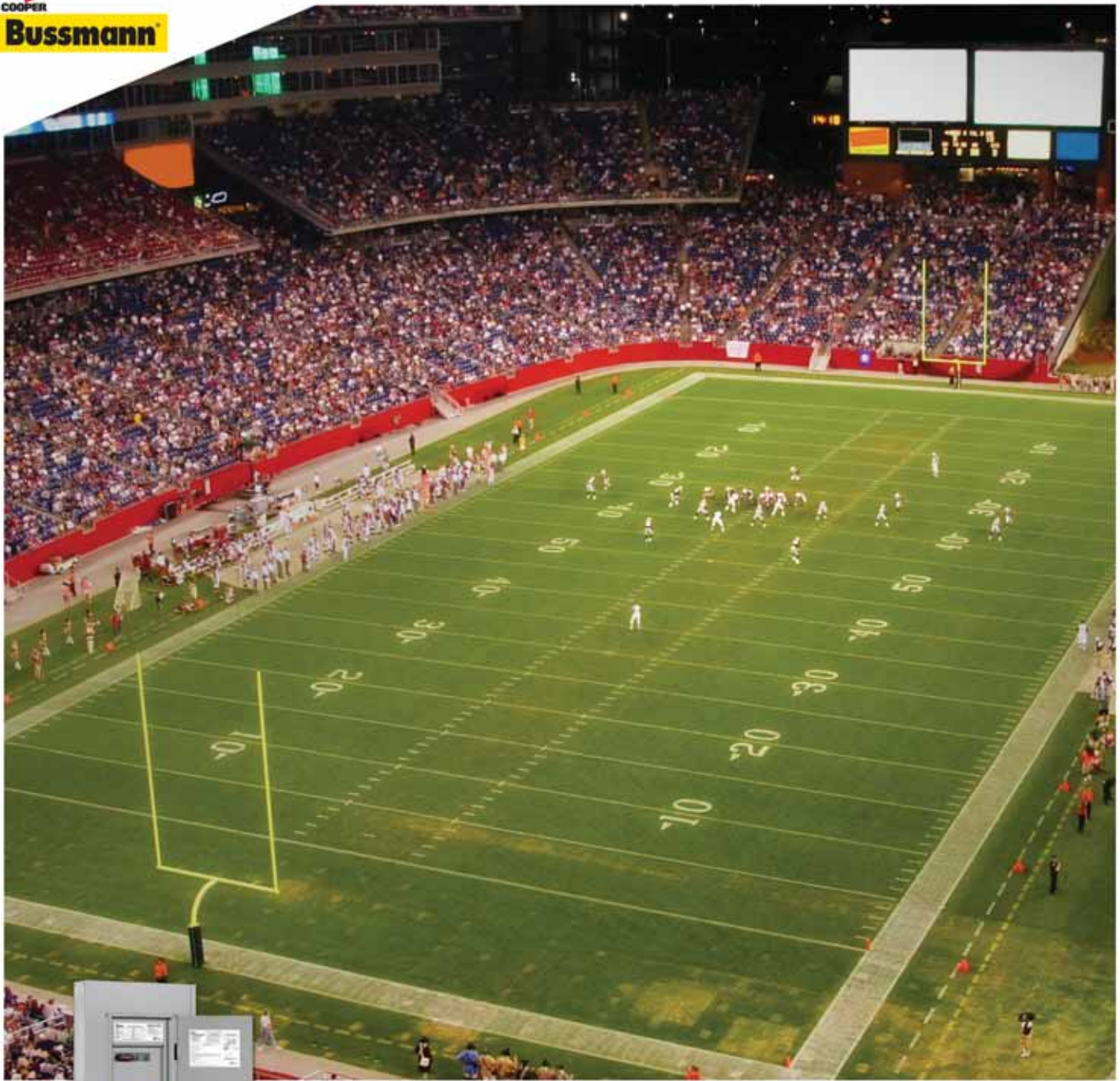

## Quik-Spec™ Coordination Panelboard

The New Standard in Panelboards Simplifies  
Selective Coordination with More Flexible  
Configurations and Features





## Стандарт Электрон Связь

Мы молодая и активно развивающаяся компания в области поставок электронных компонентов. Мы поставляем электронные компоненты отечественного и импортного производства напрямую от производителей и с крупнейших складов мира.

Благодаря сотрудничеству с мировыми поставщиками мы осуществляем комплексные и плановые поставки широчайшего спектра электронных компонентов.

Собственная эффективная логистика и склад в обеспечивает надежную поставку продукции в точно указанные сроки по всей России.

Мы осуществляем техническую поддержку нашим клиентам и предпродажную проверку качества продукции. На все поставляемые продукты мы предоставляем гарантию .

Осуществляем поставки продукции под контролем ВП МО РФ на предприятия военно-промышленного комплекса России , а также работаем в рамках 275 ФЗ с открытием отдельных счетов в уполномоченном банке. Система менеджмента качества компании соответствует требованиям ГОСТ ISO 9001.

Минимальные сроки поставки, гибкие цены, неограниченный ассортимент и индивидуальный подход к клиентам являются основой для выстраивания долгосрочного и эффективного сотрудничества с предприятиями радиоэлектронной промышленности, предприятиями ВПК и научно-исследовательскими институтами России.

С нами вы становитесь еще успешнее!

### Наши контакты:

**Телефон:** +7 812 627 14 35

**Электронная почта:** [sales@st-electron.ru](mailto:sales@st-electron.ru)

**Адрес:** 198099, Санкт-Петербург,  
Промышленная ул, дом № 19, литера Н,  
помещение 100-Н Офис 331