

Surface Mount Glass Passivated Rectifier

DO-214AB (SMC)

FEATURES

- Low profile package
- Ideal for automated placement
- Glass passivated chip junction
- Low forward voltage drop
- Low leakage current
- High forward surge capability
- Meets MSL level 1, per J-STD-020, LF maximum peak of 260 °C
- AEC-Q101 qualified
- Material categorization: For definitions of compliance please see www.vishay.com/doc?99912

RoHS
COMPLIANT

TYPICAL APPLICATIONS

For use in general purpose rectification of power supplies, inverters, converters, and freewheeling diodes for consumer, automotive, and telecommunication.

MECHANICAL DATA

Case: DO-214AB (SMC)

Molding compound meets UL 94 V-0 flammability rating
 Base P/N-E3 - RoHS-compliant, commercial grade
 Base P/NHE3_X - RoHS-compliant and AEC-Q101 qualified
 ("_X" denotes revision code e.g. A, B,.....)

Terminals: Matte tin plated leads, solderable per J-STD-002 and JESD 22-B102

E3 suffix meets JESD 201 class 2 whisker test, HE3 suffix meets JESD 201 class 2 whisker test

Polarity: Color band denotes cathode end

PRIMARY CHARACTERISTICS	
$I_{F(AV)}$	3.0 A
V_{RRM}	50 V, 100 V, 200 V, 400 V, 600 V, 800 V, 1000 V
I_{FSM}	100 A
I_R	10 μ A
V_F	1.15 V
$T_J \text{ max.}$	150 °C
Package	DO-214AB (SMC)
Diode variations	Single die

MAXIMUM RATINGS ($T_A = 25$ °C unless otherwise noted)									
PARAMETER	SYMBOL	S3A	S3B	S3D	S3G	S3J	S3K	S3M	UNIT
Device marking code		SA	SB	SD	SG	SJ	SK	SM	
Maximum recurrent peak reverse voltage	V_{RRM}	50	100	200	400	600	800	1000	V
Maximum RMS voltage	V_{RMS}	35	70	140	280	420	560	700	V
Maximum DC blocking voltage	V_{DC}	50	100	200	400	600	800	1000	V
Maximum average forward rectified current at $T_L = 103$ °C	$I_{F(AV)}$	3.0							A
Peak forward surge current 8.3 ms single half sine-wave superimposed on rated load	I_{FSM}	100							A
Operating junction and storage temperature range	T_J, T_{STG}	- 55 to + 150							°C



ELECTRICAL CHARACTERISTICS (T _A = 25 °C unless otherwise noted)										
PARAMETER	TEST CONDITIONS	SYMBOL	S3A	S3B	S3D	S3G	S3J	S3K	S3M	UNIT
Maximum instantaneous forward voltage	2.5 A	V _F	1.15							V
Maximum DC reverse current at rated DC blocking voltage	T _A = 25 °C	I _R	10							μA
	T _A = 125 °C		250							
Typical reverse recovery time	I _F = 0.5 A, I _R = 1.0 A, I _{rr} = 0.25 A	t _{rr}	2.5							μs
Typical junction capacitance	4.0 V, 1 MHz	C _J	60							pF

THERMAL CHARACTERISTICS (T _A = 25 °C unless otherwise noted)										
PARAMETER	SYMBOL	S3A	S3B	S3D	S3G	S3J	S3K	S3M	UNIT	
Typical thermal resistance ⁽¹⁾	R _{θJA}	47							°C/W	
	R _{θJL}	13								

Note

⁽¹⁾ Thermal resistance from junction to ambient and from junction to lead mounted on PCB with 0.3" x 0.3" (8.0 mm x 8.0 mm) copper pad area

ORDERING INFORMATION (Example)				
PREFERRED P/N	UNIT WEIGHT (g)	PREFERRED PACKAGE CODE	BASE QUANTITY	DELIVERY MODE
S3J-E3/57T	0.211	57T	850	7" diameter plastic tape and reel
S3J-E3/9AT	0.211	9AT	3500	13" diameter plastic tape and reel
S3JHE3_A/H ⁽¹⁾	0.211	H	850	7" diameter plastic tape and reel
S3JHE3_A/I ⁽¹⁾	0.211	I	3500	13" diameter plastic tape and reel

Note

⁽¹⁾ AEC-Q101 qualified

RATINGS AND CHARACTERISTICS CURVES (T_A = 25 °C unless otherwise noted)

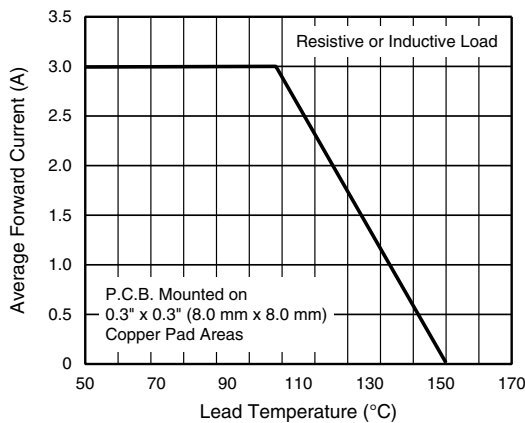

Fig. 1 - Forward Current Derating Curve

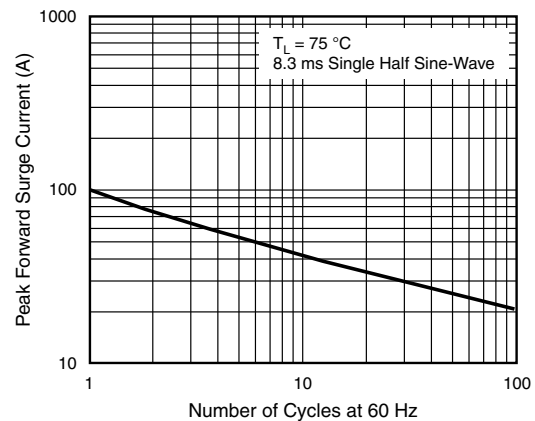

Fig. 2 - Maximum Non-Repetitive Peak Forward Surge Current

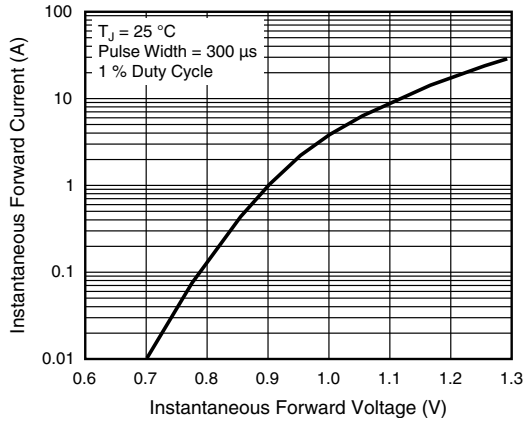

Fig. 3 - Typical Instantaneous Forward Characteristics

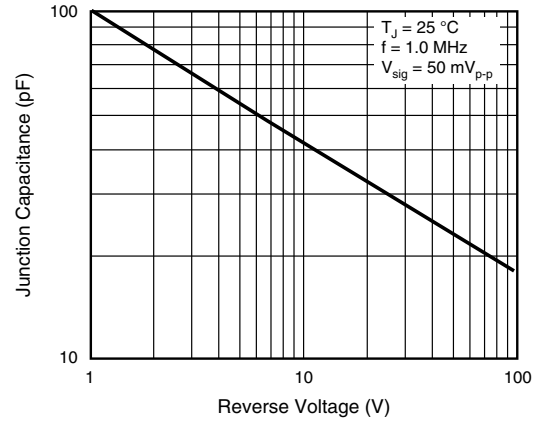

Fig. 5 - Typical Junction Capacitance

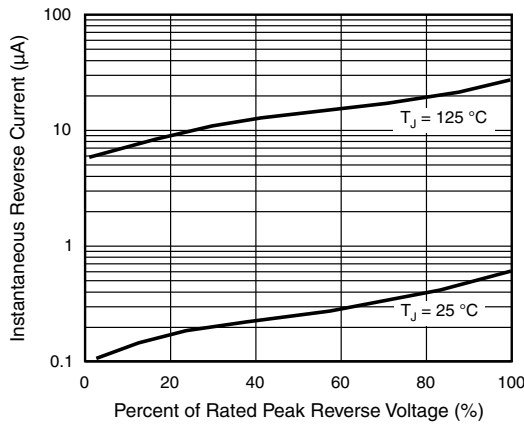

Fig. 4 - Typical Reverse Characteristics

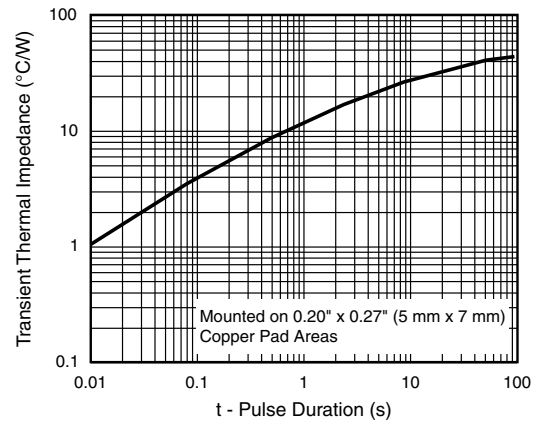
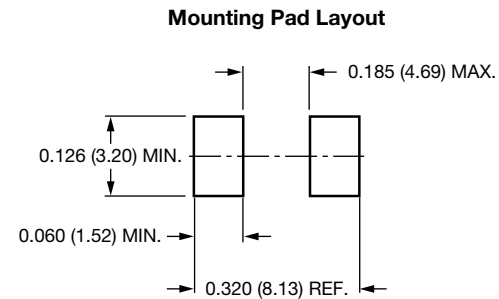
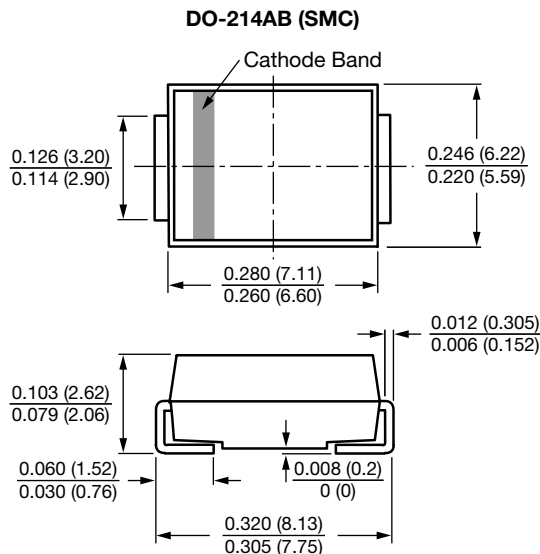

Fig. 6 - Typical Transient Thermal Impedance

PACKAGE OUTLINE DIMENSIONS in inches (millimeters)





Disclaimer

ALL PRODUCT, PRODUCT SPECIFICATIONS AND DATA ARE SUBJECT TO CHANGE WITHOUT NOTICE TO IMPROVE RELIABILITY, FUNCTION OR DESIGN OR OTHERWISE.

Vishay Intertechnology, Inc., its affiliates, agents, and employees, and all persons acting on its or their behalf (collectively, "Vishay"), disclaim any and all liability for any errors, inaccuracies or incompleteness contained in any datasheet or in any other disclosure relating to any product.

Vishay makes no warranty, representation or guarantee regarding the suitability of the products for any particular purpose or the continuing production of any product. To the maximum extent permitted by applicable law, Vishay disclaims (i) any and all liability arising out of the application or use of any product, (ii) any and all liability, including without limitation special, consequential or incidental damages, and (iii) any and all implied warranties, including warranties of fitness for particular purpose, non-infringement and merchantability.

Statements regarding the suitability of products for certain types of applications are based on Vishay's knowledge of typical requirements that are often placed on Vishay products in generic applications. Such statements are not binding statements about the suitability of products for a particular application. It is the customer's responsibility to validate that a particular product with the properties described in the product specification is suitable for use in a particular application. Parameters provided in datasheets and/or specifications may vary in different applications and performance may vary over time. All operating parameters, including typical parameters, must be validated for each customer application by the customer's technical experts. Product specifications do not expand or otherwise modify Vishay's terms and conditions of purchase, including but not limited to the warranty expressed therein.

Except as expressly indicated in writing, Vishay products are not designed for use in medical, life-saving, or life-sustaining applications or for any other application in which the failure of the Vishay product could result in personal injury or death. Customers using or selling Vishay products not expressly indicated for use in such applications do so at their own risk. Please contact authorized Vishay personnel to obtain written terms and conditions regarding products designed for such applications.

No license, express or implied, by estoppel or otherwise, to any intellectual property rights is granted by this document or by any conduct of Vishay. Product names and markings noted herein may be trademarks of their respective owners.

Material Category Policy

Vishay Intertechnology, Inc. hereby certifies that all its products that are identified as RoHS-Compliant fulfill the definitions and restrictions defined under Directive 2011/65/EU of The European Parliament and of the Council of June 8, 2011 on the restriction of the use of certain hazardous substances in electrical and electronic equipment (EEE) - recast, unless otherwise specified as non-compliant.

Please note that some Vishay documentation may still make reference to RoHS Directive 2002/95/EC. We confirm that all the products identified as being compliant to Directive 2002/95/EC conform to Directive 2011/65/EU.

Vishay Intertechnology, Inc. hereby certifies that all its products that are identified as Halogen-Free follow Halogen-Free requirements as per JEDEC JS709A standards. Please note that some Vishay documentation may still make reference to the IEC 61249-2-21 definition. We confirm that all the products identified as being compliant to IEC 61249-2-21 conform to JEDEC JS709A standards.



**Стандарт
Электрон
Связь**

Мы молодая и активно развивающаяся компания в области поставок электронных компонентов. Мы поставляем электронные компоненты отечественного и импортного производства напрямую от производителей и с крупнейших складов мира.

Благодаря сотрудничеству с мировыми поставщиками мы осуществляем комплексные и плановые поставки широчайшего спектра электронных компонентов.

Собственная эффективная логистика и склад в обеспечивает надежную поставку продукции в точно указанные сроки по всей России.

Мы осуществляем техническую поддержку нашим клиентам и предпродажную проверку качества продукции. На все поставляемые продукты мы предоставляем гарантию .

Осуществляем поставки продукции под контролем ВП МО РФ на предприятия военно-промышленного комплекса России , а также работаем в рамках 275 ФЗ с открытием отдельных счетов в уполномоченном банке. Система менеджмента качества компании соответствует требованиям ГОСТ ISO 9001.

Минимальные сроки поставки, гибкие цены, неограниченный ассортимент и индивидуальный подход к клиентам являются основой для выстраивания долгосрочного и эффективного сотрудничества с предприятиями радиоэлектронной промышленности, предприятиями ВПК и научно-исследовательскими институтами России.

С нами вы становитесь еще успешнее!

Наши контакты:

Телефон: +7 812 627 14 35

Электронная почта: sales@st-electron.ru

Адрес: 198099, Санкт-Петербург,
Промышленная ул, дом № 19, литера Н,
помещение 100-Н Офис 331