

## AMP03

### FEATURES

**High CMRR: 100 dB Typ**  
**Low Nonlinearity: 0.001% Max**  
**Low Distortion: 0.001% Typ**  
**Wide Bandwidth: 3 MHz Typ**  
**Fast Slew Rate: 9.5 V/ $\mu$ s Typ**  
**Fast Settling (0.01%): 1  $\mu$ s Typ**  
**Low Cost**

### APPLICATIONS

**Summing Amplifiers**  
**Instrumentation Amplifiers**  
**Balanced Line Receivers**  
**Current-Voltage Conversion**  
**Absolute Value Amplifier**  
**4 to 20 mA Current Transmitter**  
**Precision Voltage Reference Applications**  
**Lower Cost and Higher Speed Version of INA105**

### GENERAL DESCRIPTION

The AMP03 is a monolithic unity-gain, high speed differential amplifier. Incorporating a matched thin film resistor network, the AMP03 features stable operation over temperature without requiring expensive external matched components. The AMP03 is a basic analog building block for differential amplifier and instrumentation applications.

The differential amplifier topology of the AMP03 both amplifies the difference between two signals and provides extremely high rejection of the common-mode input voltage. By providing common-mode rejection (CMR) of 100 dB typical, the AMP03 solves common problems encountered in instrumentation design. As an example, the AMP03 is ideal for performing either addition or subtraction of two signals without using expensive externally matched precision resistors. The large common-mode rejection is made possible by matching the internal resistors to better than 0.002% and maintaining a thermally symmetric layout. Additionally, due to high CMR over frequency, the AMP03 is an ideal general amplifier for buffering signals in a noisy environment into data acquisition systems.

The AMP03 is a higher speed alternative to the INA105. Featuring slew rates of 9.5 V/ $\mu$ s and a bandwidth of 3 MHz, the AMP03 offers superior performance to the INA105 for high speed current sources, absolute value amplifiers, and summing amplifiers.

REV. F

Information furnished by Analog Devices is believed to be accurate and reliable. However, no responsibility is assumed by Analog Devices for its use, nor for any infringements of patents or other rights of third parties that may result from its use. No license is granted by implication or otherwise under any patent or patent rights of Analog Devices. Trademarks and registered trademarks are the property of their respective owners.

### FUNCTIONAL BLOCK DIAGRAM

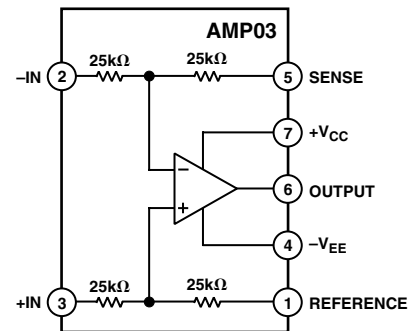

### PIN CONNECTIONS

#### 8-Lead PDIP (P Suffix)

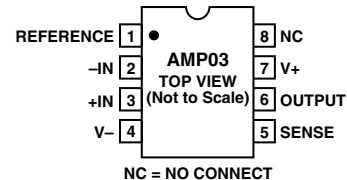

#### 8-Lead SOIC (S Suffix)

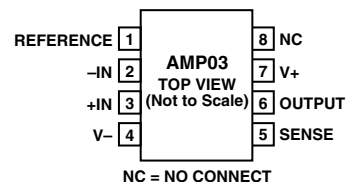

#### Header (J Suffix)

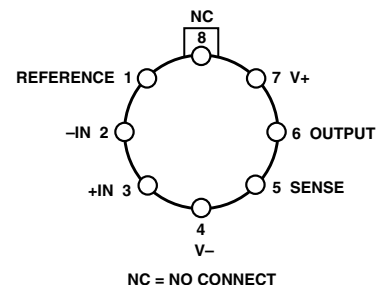

# AMP03—SPECIFICATIONS

## ELECTRICAL CHARACTERISTICS (@ $V_S = \pm 15\text{ V}$ , $T_A = +25^\circ\text{C}$ , unless otherwise noted.)

Parameter	Symbol	Conditions	AMP03F			AMP03B			AMP03G			Unit
			Min	Typ	Max	Min	Typ	Max	Min	Typ	Max	
Offset Voltage	$V_{OS}$	$V_{CM} = 0\text{ V}$	-400	+10	+400	-700	+20	+700	-750	+25	+750	$\mu\text{V}$
Gain Error		No Load, $V_{IN} = \pm 10\text{ V}$ , $R_S = 0\ \Omega$		0.00004	0.008		0.00004	0.008		0.001	0.008	%
Input Voltage Range	IVR	(Note 1)	$\pm 20$			$\pm 20$			$\pm 20$			V
Common-Mode Rejection	CMR	$V_{CM} = \pm 10\text{ V}$	85	100		80	95		80	95		dB
Power Supply Rejection Ratio	PSRR	$V_S = \pm 6\text{ V}$ to $\pm 18\text{ V}$		0.6	10		0.6	10		0.7	10	$\mu\text{V/V}$
Output Swing	$V_O$	$R_L = 2\text{ k}\Omega$	$\pm 12$	$\pm 13.7$		$\pm 12$	$\pm 13.7$		$\pm 12$	$\pm 13.7$		V
Short-Circuit Current Limit	$I_{SC}$	Output Shorted to Ground	$+45/-15$			$+45/-15$			$+45/-15$			mA
Small-Signal Bandwidth (-3 dB)	BW	$R_L = 2\text{ k}\Omega$		3			3			3		MHz
Slew Rate	SR	$R_L = 2\text{ k}\Omega$	6	9.5		6	9.5		6	9.5		V/ $\mu\text{s}$
Capacitive Load Drive Capability	$C_L$	No Oscillation		300			300			300		pF
Supply Current	$I_{SY}$	No Load		2.5	3.5		2.5	3.5		2.5	3.5	mA

### NOTES

<sup>1</sup>Input voltage range guaranteed by CMR test.

Specifications subject to change without notice.

## ELECTRICAL CHARACTERISTICS (@ $V_S = \pm 15\text{ V}$ , $-55^\circ\text{C} \leq T_A \leq +125^\circ\text{C}$ for B Grade)

Parameter	Symbol	Conditions	AMP03B			Unit
			Min	Typ	Max	
Offset Voltage	$V_{OS}$	$V_{CM} = 0\text{ V}$	-1500	+150	+1500	$\mu\text{V}$
Gain Error		No Load, $V_{IN} = \pm 10\text{ V}$ , $R_S = 0\ \Omega$		0.0014	0.02	%
Input Voltage Range	IVR		$\pm 20$			V
Common-Mode Rejection	CMR	$V_{CM} = \pm 10\text{ V}$	75	95		dB
Power Supply Rejection Ratio	PSRR	$V_S = \pm 6\text{ V}$ to $\pm 18\text{ V}$		0.7	20	$\mu\text{V/V}$
Output Swing	$V_O$	$R_L = 2\text{ k}\Omega$	$\pm 12$	$\pm 13.7$		V
Slew Rate	SR	$R_L = 2\text{ k}\Omega$		9.5		V/ $\mu\text{s}$
Supply Current	$I_{SY}$	No Load		3.0	4.0	mA

Specifications subject to change without notice.

## ELECTRICAL CHARACTERISTICS (@ $V_S = \pm 15\text{ V}$ , $-40^\circ\text{C} \leq T_A \leq +85^\circ\text{C}$ for F and G Grades)

Parameter	Symbol	Conditions	AMP03F			AMP03G			Unit
			Min	Typ	Max	Min	Typ	Max	
Offset Voltage	$V_{OS}$	$V_{CM} = 0\text{ V}$	-1000	+100	+1000	-2000	+200	+2000	$\mu\text{V}$
Gain Error		No Load, $V_{IN} = \pm 10\text{ V}$ , $R_S = 0\ \Omega$		0.0008	0.015		0.002	0.02	%
Input Voltage Range	IVR		$\pm 20$			$\pm 20$			V
Common-Mode Rejection	CMR	$V_{CM} = \pm 10\text{ V}$	80	95		75	90		dB
Power Supply Rejection Ratio	PSRR	$V_S = \pm 6\text{ V}$ to $\pm 18\text{ V}$		0.7	15		1.0	15	$\mu\text{V/V}$
Output Swing	$V_O$	$R_L = 2\text{ k}\Omega$	$\pm 12$	$\pm 13.7$		$\pm 12$	$\pm 13.7$		V
Slew Rate	SR	$R_L = 2\text{ k}\Omega$		9.5			9.5		V/ $\mu\text{s}$
Supply Current	$I_{SY}$	No Load		2.6	4.0		2.6	4.0	mA

Specifications subject to change without notice.

## WAFER TEST LIMITS (@ $V_S = \pm 15\text{ V}$ , $T_A = 25^\circ\text{C}$ , unless otherwise noted.)\*

Parameter	Symbol	Conditions	AMP03GBC Limit	Unit
Offset Voltage	$V_{OS}$	$V_S = \pm 18\text{ V}$	0.5	mV max
Gain Error		No Load, $V_{IN} = \pm 10\text{ V}$ , $R_S = 0\ \Omega$	0.008	% max
Input Voltage Range	IVR		$\pm 10$	V min
Common-Mode Rejection	CMR	$V_{CM} = \pm 10\text{ V}$	80	dB min
Power Supply Rejection Ratio	PSRR	$V_S = \pm 6\text{ V}$ to $\pm 18\text{ V}$	8	$\mu\text{V/V}$ max
Output Swing	$V_O$	$R_L = 2\text{ k}\Omega$	$\pm 12$	V max
Short-Circuit Current Limit	$I_{SC}$	Output Shorted to Ground	+45/-15	mA min
Supply Current	$I_{SY}$	No Load	3.5	mA max

\*Electrical tests are performed at wafer probe to the limits shown. Due to variations in assembly methods and normal yield loss, yield after packaging is not guaranteed for standard product dice. Consult factory to negotiate specifications based on dice lot qualifications through sample lot assembly and testing.

### ABSOLUTE MAXIMUM RATINGS<sup>1</sup>

Supply Voltage	$\pm 18\text{ V}$
Input Voltage <sup>2</sup>	Supply Voltage
Output Short-Circuit Duration	Continuous
Storage Temperature Range	
P, J Package	$-65^\circ\text{C}$ to $+150^\circ\text{C}$
Lead Temperature (Soldering, 60 sec)	$300^\circ\text{C}$
Junction Temperature	$150^\circ\text{C}$
Operating Temperature Range	
AMP03B	$-55^\circ\text{C}$ to $+125^\circ\text{C}$
AMP03F, AMP03G	$-40^\circ\text{C}$ to $+85^\circ\text{C}$

Package Type	$\theta_{JA}$ <sup>3</sup>	$\theta_{JC}$	Unit
Header (J)	150	18	$^\circ\text{C/W}$
8-Lead PDIP (P)	103	43	$^\circ\text{C/W}$
8-Lead SOIC (S)	155	40	$^\circ\text{C/W}$

### NOTES

<sup>1</sup>Absolute maximum ratings apply to both DICE and packaged parts, unless otherwise noted.

<sup>2</sup>For supply voltages less than  $\pm 18\text{ V}$ , the absolute maximum input voltage is equal to the supply voltage.

<sup>3</sup> $\theta_{JA}$  is specified for worst-case mounting conditions, i.e.,  $\theta_{JA}$  is specified for device in socket for header and PDIP packages and for device soldered to printed circuit board for SOIC package.

### ORDERING GUIDE

Model <sup>1</sup>	Temperature Range	Package Description	Package Option <sup>2</sup>
AMP03GP	$-40^\circ\text{C}$ to $+85^\circ\text{C}$	8-Lead PDIP	P-8
AMP03BJ	$-40^\circ\text{C}$ to $+85^\circ\text{C}$	Header	H-08B
AMP03FJ	$-40^\circ\text{C}$ to $+85^\circ\text{C}$	Header	H-08B
AMP03BJ/883C	$-55^\circ\text{C}$ to $+125^\circ\text{C}$	Header	H-08B
AMP03GS	$-40^\circ\text{C}$ to $+85^\circ\text{C}$	8-Lead SOIC	S-8
AMP03GS-REEL	$-40^\circ\text{C}$ to $+85^\circ\text{C}$	8-Lead SOIC	S-8
5962-9563901MGA	$-55^\circ\text{C}$ to $+125^\circ\text{C}$	Header	H-08B
AMP03GBC		Die	

### NOTES

<sup>1</sup>Burn-in is available on commercial and industrial temperature range parts in PDIP and header packages.

<sup>2</sup>Consult factory for /883 data sheet.

### CAUTION

ESD (electrostatic discharge) sensitive device. Electrostatic charges as high as 4000 V readily accumulate on the human body and test equipment and can discharge without detection. Although the AMP03 features proprietary ESD protection circuitry, permanent damage may occur on devices subjected to high energy electrostatic discharges. Therefore, proper ESD precautions are recommended to avoid performance degradation or loss of functionality.

### DICE CHARACTERISTICS

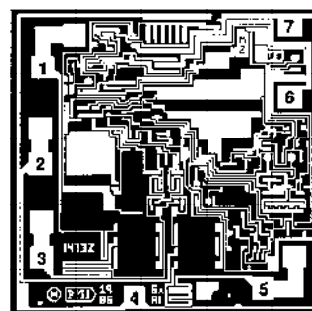

1. REFERENCE
2. -IN
3. +IN
4. -VEE
5. SENSE
6. OUTPUT
7. +VCC
8. NC

DIE SIZE 0.076 inch  $\times$  0.076 inch, 5,776 sq. mm  
(1.93 mm  $\times$  1.93 mm, 3.73 sq. mm)

### BURN-IN CIRCUIT

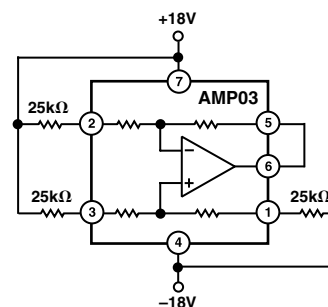

### SLEW RATE TEST CIRCUIT

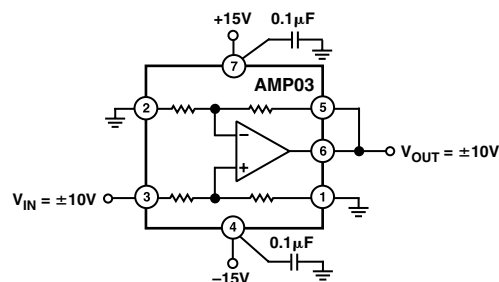

# AMP03—Typical Performance Characteristics

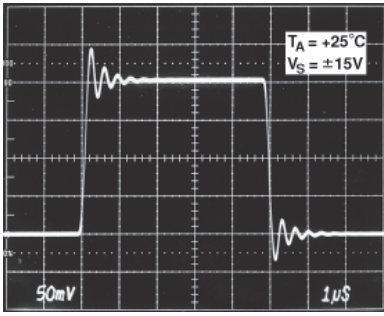

TPC 1. Small Signal Transient Response

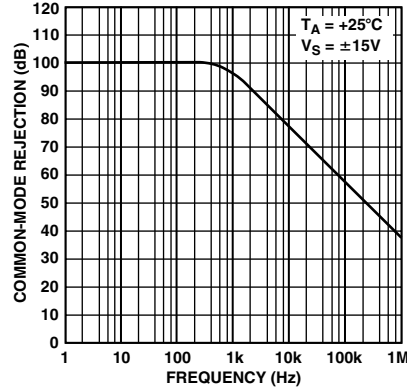

TPC 2. Common-Mode Rejection vs. Frequency

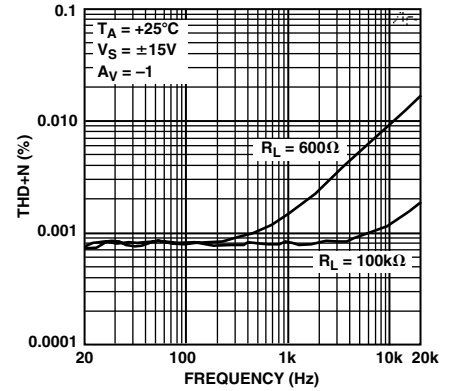

TPC 3. Total Harmonic Distortion vs. Frequency

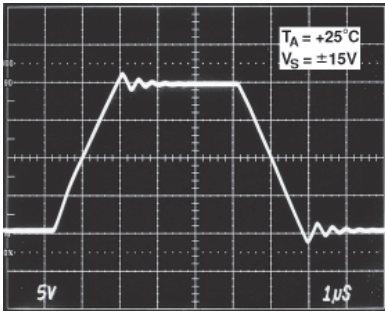

TPC 4. Large Signal Transient Response

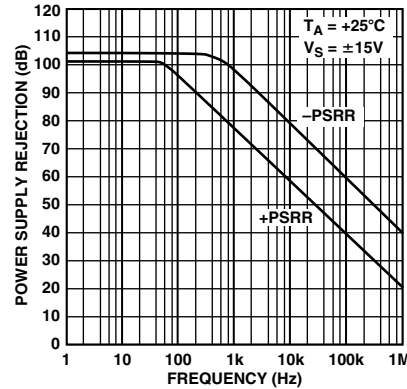

TPC 5. Power Supply Rejection vs. Frequency

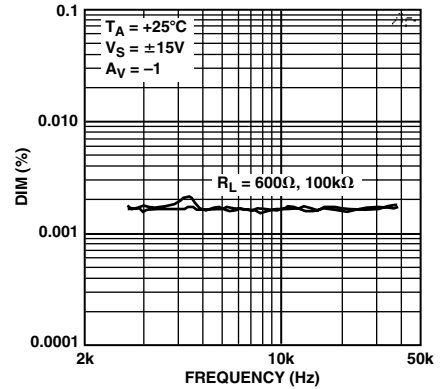

TPC 6. Dynamic Intermodulation Distortion vs. Frequency

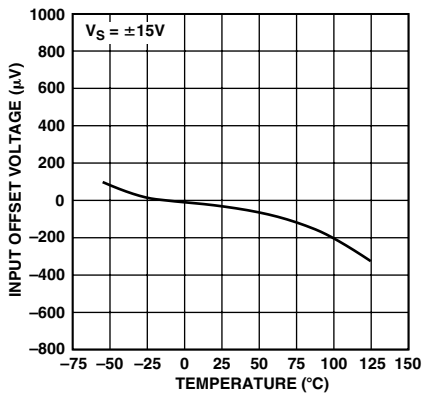

TPC 7. Input Offset Voltage vs. Temperature

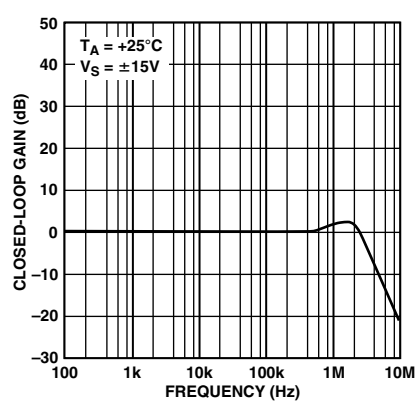

TPC 8. Closed-Loop Gain vs. Frequency

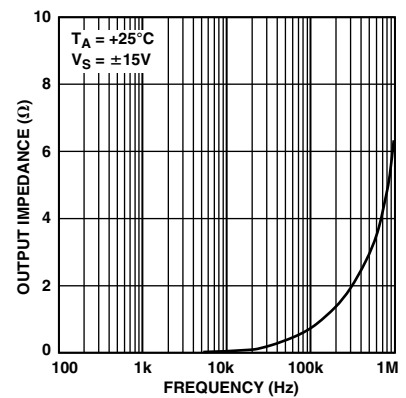

TPC 9. Closed-Loop Output Impedance vs. Frequency

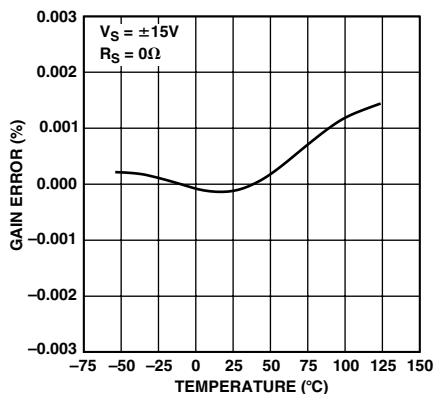

TPC 10. Gain Error vs. Temperature

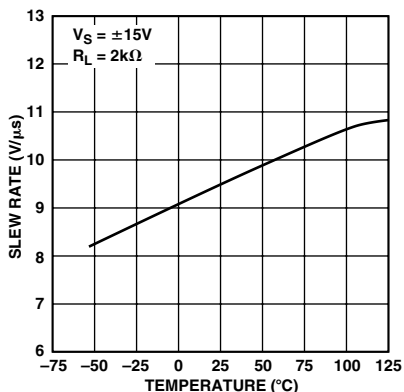

TPC 11. Slew Rate vs. Temperature

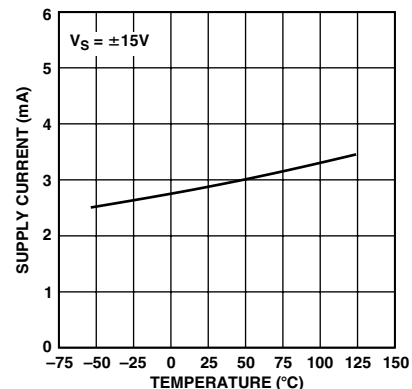

TPC 12. Supply Current vs. Temperature

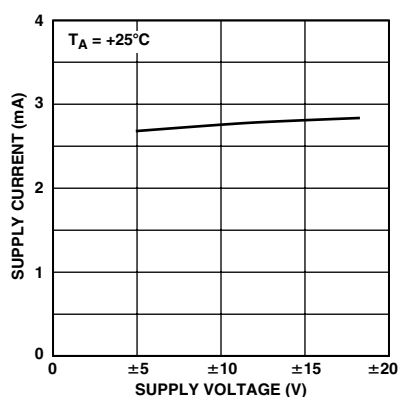

TPC 13. Supply Current vs. Supply Voltage

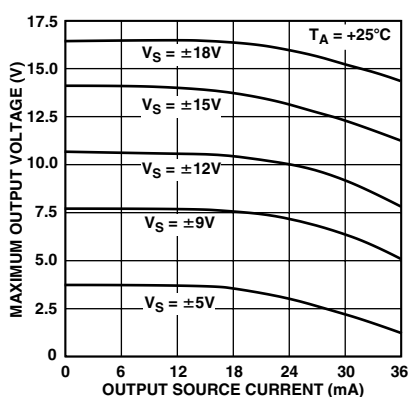

TPC 14. Maximum Output Voltage vs. Output Current (Source)

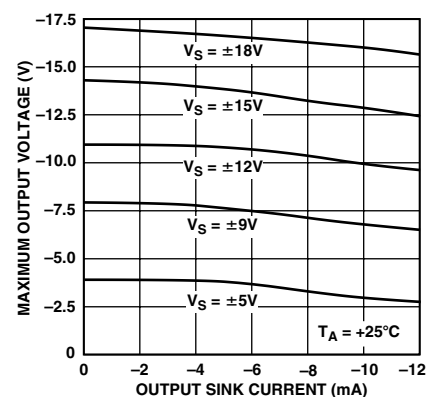

TPC 15. Maximum Output Voltage vs. Output Current (Sink)

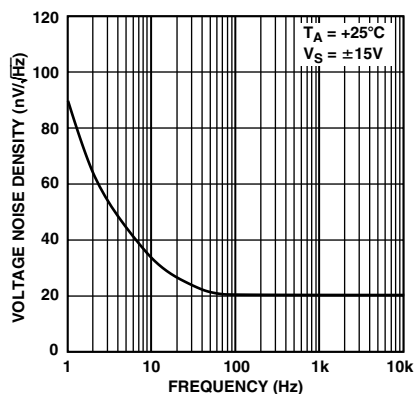

TPC 16. Voltage Noise Density vs. Frequency

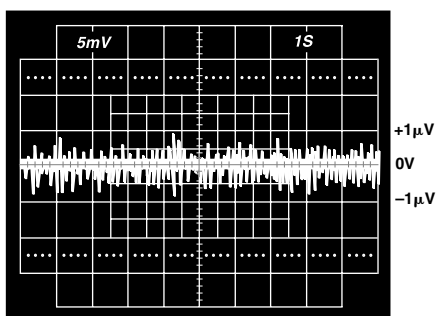

0.1 TO 10Hz PEAK-TO-PEAK NOISE

TPC 17. Low Frequency Voltage Noise

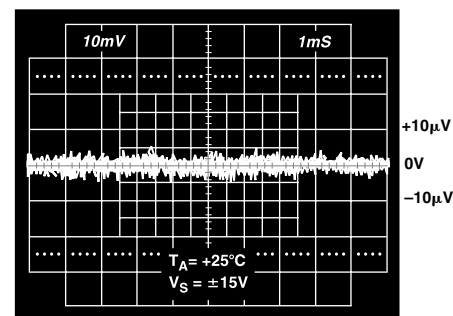

NOTE: EXTERNAL AMPLIFIER GAIN = 1000; THEREFORE, VERTICAL SCALE = 10μV/DIV.

TPC 18. Voltage Noise from 0 kHz to 1 kHz

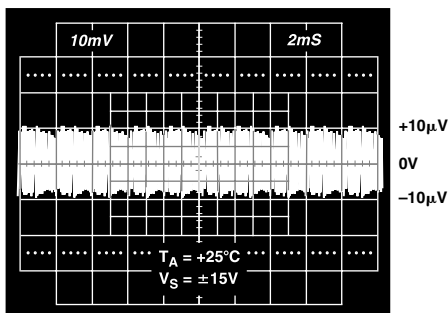

NOTE: EXTERNAL AMPLIFIER GAIN = 1000; THEREFORE, VERTICAL SCALE = 10μV/DIV.

TPC 19. Voltage Noise from 0 kHz to 10 kHz

# AMP03

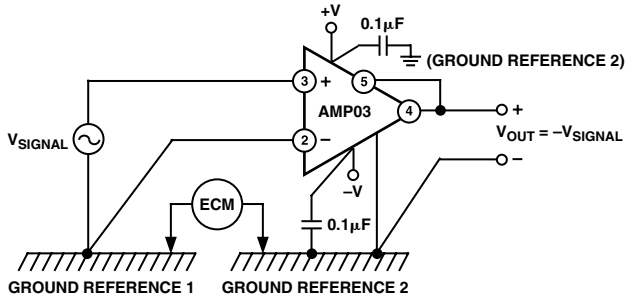

Figure 1. AMP03 Serves to Reject Common-Mode Voltages in Instrumentation Systems. Common-Mode Voltages Occur Due to Ground Current Returns.  $V_{\text{SIGNAL}}$  and  $E_{\text{CM}}$  Must Be within the Common-Mode Range of AMP03.

## APPLICATIONS INFORMATION

The AMP03 represents a versatile analog building block. In order to capitalize on the fast settling time, high slew rate, and high CMR, proper decoupling and grounding techniques must be employed. Figure 1 illustrates the use of 0.1 μF decoupling capacitors and proper ground connections.

## MAINTAINING COMMON-MODE REJECTION

In order to achieve the full common-mode rejection capability of the AMP03, the source impedance must be carefully controlled. Slight imbalances of the source resistance will result in a degradation of dc CMR—even a 5 Ω imbalance will degrade CMR by 20 dB. Also, the matching of the reactive source impedance must be matched in order to preserve the CMRR over frequency.

## APPLICATION CIRCUITS

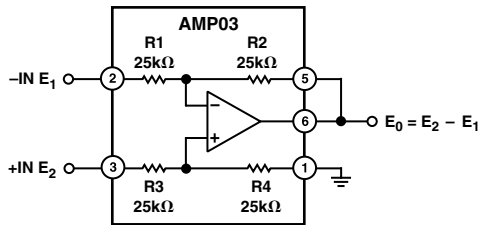

Figure 2. Precision Difference Amplifier. Rejects Common-Mode Signal =  $(E_1 + E_2)/2$  by 100 dB

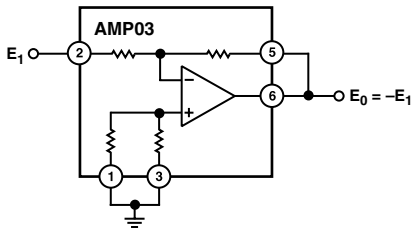

Figure 3. Precision Unity-Gain Inverting Amplifier

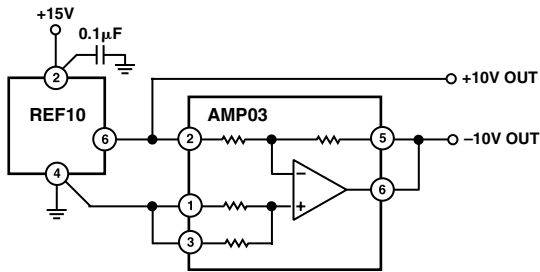

Figure 4. ±10 V Precision Voltage Reference

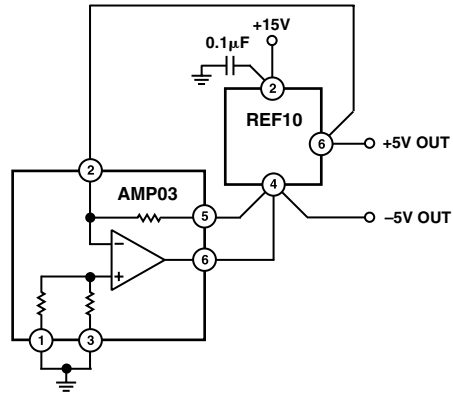

Figure 5. ±5 V Precision Voltage Reference

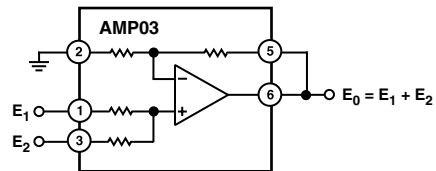

Figure 6. Precision Summing Amplifier

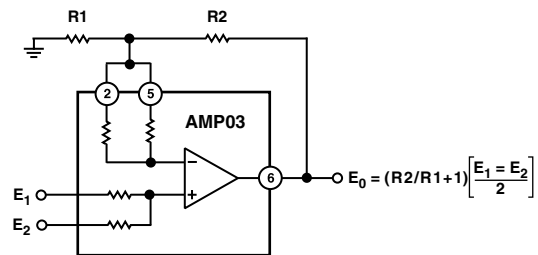

Figure 7. Precision Summing Amplifier with Gain

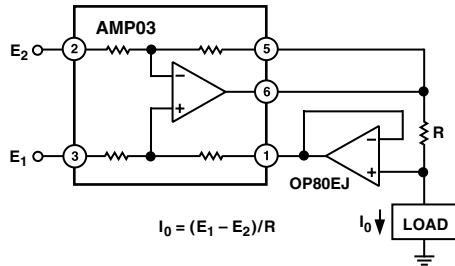

Figure 8. Differential Input Voltage-to-Current Converter for Low  $I_{OUT}$ . OP80EJ maintains 250 fA max input current, allowing  $I_0$  to be less than 1 pA.

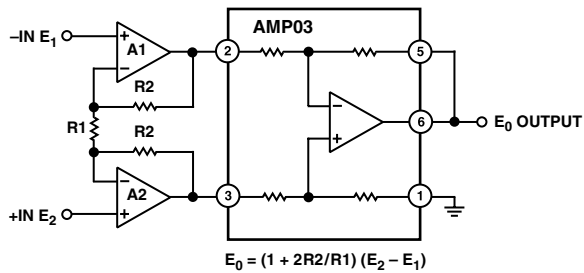

Figure 9. Suitable Instrumentation Amplifier Requirements Can Be Addressed by Using an Input Stage Consisting of A1, A2, R1, and R2. The following matrix suggests a suitable amplifier.

System Design Requirement	Suggested Op Amp For A1 and A2
Source Impedance Low, Need Low Voltage Noise Performance	OP27, OP37 OP227 (Dual Matched) OP270 (Dual) OP271 OP470 OP471
Source Impedance High ( $R_S \geq 15 \text{ k}\Omega$ ). Need Low Current Noise	OP80 OP41 OP43 OP249 OP97
Require Ultrahigh Input Impedance	OP80 OP97 OP41 OP43
Need Wider Bandwidth and High Speed	OP42 OP43 OP249

## OUTLINE DIMENSIONS

### 8-Lead Plastic Dual In-Line Package [PDIP] [P Suffix] (N-8)

Dimensions shown in inches and (millimeters)

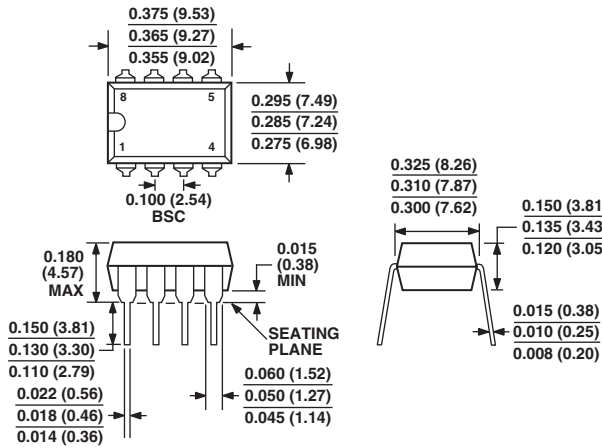

COMPLIANT TO JEDEC STANDARDS MO-095AA

CONTROLLING DIMENSIONS ARE IN INCHES; MILLIMETER DIMENSIONS (IN PARENTHESES) ARE ROUNDED-OFF INCH EQUIVALENTS FOR REFERENCE ONLY AND ARE NOT APPROPRIATE FOR USE IN DESIGN

### 8-Lead Small Outline Package [SOIC] [S Suffix] (R-8)

Dimensions shown in millimeters and (inches)

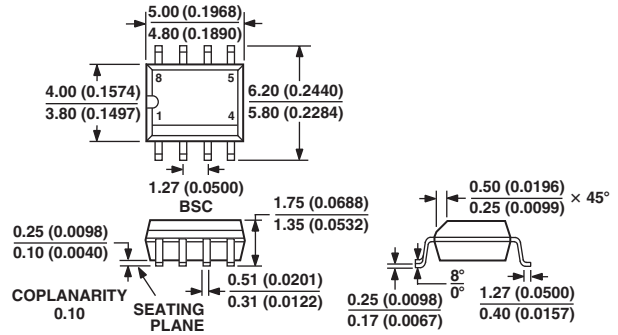

COMPLIANT TO JEDEC STANDARDS MS-012AA

CONTROLLING DIMENSIONS ARE IN MILLIMETERS; INCH DIMENSIONS (IN PARENTHESES) ARE ROUNDED-OFF MILLIMETER EQUIVALENTS FOR REFERENCE ONLY AND ARE NOT APPROPRIATE FOR USE IN DESIGN

### 8-Lead Metal Can [TO-99] [J Suffix] (H-08B)

Dimensions shown in inches and (millimeters)

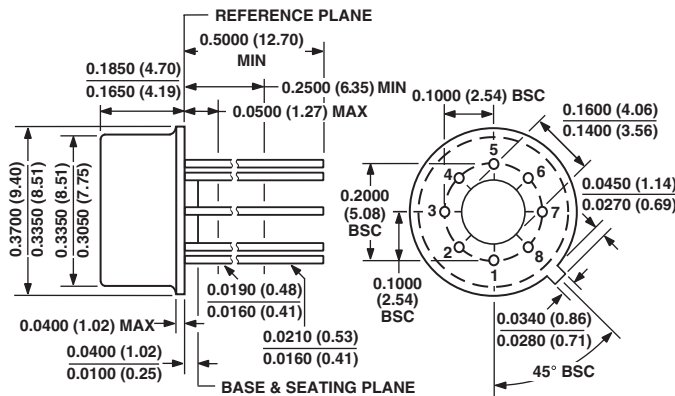

COMPLIANT TO JEDEC STANDARDS MO-002AK

CONTROLLING DIMENSIONS ARE IN INCHES; MILLIMETERS DIMENSIONS (IN PARENTHESES) ARE ROUNDED-OFF INCH EQUIVALENTS FOR REFERENCE ONLY AND ARE NOT APPROPRIATE FOR USE IN DESIGN

## Revision History

Location	Page
12/03—Data Sheet changed from REV. E to REV. F.	
Changes to ELECTRICAL CHARACTERISTICS	2
Changes to ORDERING GUIDE	3
Updated OUTLINE DIMENSIONS	7





## Стандарт Электрон Связь

Мы молодая и активно развивающаяся компания в области поставок электронных компонентов. Мы поставляем электронные компоненты отечественного и импортного производства напрямую от производителей и с крупнейших складов мира.

Благодаря сотрудничеству с мировыми поставщиками мы осуществляем комплексные и плановые поставки широчайшего спектра электронных компонентов.

Собственная эффективная логистика и склад в обеспечивает надежную поставку продукции в точно указанные сроки по всей России.

Мы осуществляем техническую поддержку нашим клиентам и предпродажную проверку качества продукции. На все поставляемые продукты мы предоставляем гарантию .

Осуществляем поставки продукции под контролем ВП МО РФ на предприятия военно-промышленного комплекса России , а также работаем в рамках 275 ФЗ с открытием отдельных счетов в уполномоченном банке. Система менеджмента качества компании соответствует требованиям ГОСТ ISO 9001.

Минимальные сроки поставки, гибкие цены, неограниченный ассортимент и индивидуальный подход к клиентам являются основой для выстраивания долгосрочного и эффективного сотрудничества с предприятиями радиоэлектронной промышленности, предприятиями ВПК и научно-исследовательскими институтами России.

С нами вы становитесь еще успешнее!

### Наши контакты:

**Телефон:** +7 812 627 14 35

**Электронная почта:** [sales@st-electron.ru](mailto:sales@st-electron.ru)

**Адрес:** 198099, Санкт-Петербург,  
Промышленная ул, дом № 19, литера Н,  
помещение 100-Н Офис 331