

## High Voltage, Input Rectifier Diode, 80 A

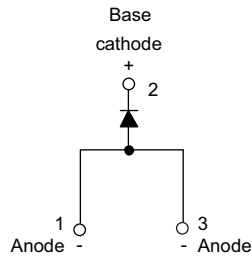

TO-247AC



### FEATURES

- Very low forward voltage drop
- 150 °C max. operating junction temperature
- Designed and qualified according to JEDEC®-JESD47
- Material categorization:  
For definitions of compliance please see [www.vishay.com/doc?99912](http://www.vishay.com/doc?99912)



### APPLICATIONS

- Input rectification
- Vishay Semiconductors switches and output rectifiers which are available in identical package outlines

### DESCRIPTION

High voltage rectifiers optimized for very low forward voltage drop with moderate leakage.

These devices are intended for use in main rectification (single or three phase bridge).

PRODUCT SUMMARY	
Package	TO-247AC
$I_{F(AV)}$	80 A
$V_R$	800 V to 1200 V
$V_F$ at $I_F$	1.17 V
$I_{FSM}$	1500 A
$T_J$ max.	150 °C
Diode variation	Single die

MAJOR RATINGS AND CHARACTERISTICS			
SYMBOL	CHARACTERISTICS	VALUES	UNITS
$I_{F(AV)}$	Sinusoidal waveform	80	A
$V_{RRM}$	Range	800/1200	V
$I_{FSM}$		1500	A
$V_F$	80 A, $T_J = 25$ °C	1.17	V
$T_J$		-40 to 150	°C

VOLTAGE RATINGS			
PART NUMBER	$V_{RRM}$ , MAXIMUM PEAK REVERSE VOLTAGE V	$V_{RSM}$ , MAXIMUM NON-REPETITIVE PEAK REVERSE VOLTAGE V	$I_{RRM}$ AT 150 °C mA
VS-80APS08PbF, VS-80APS08-M3	800	900	1.5
VS-80APS12PbF, VS-80APS12-M3	1200	1300	

ABSOLUTE MAXIMUM RATINGS				
PARAMETER	SYMBOL	TEST CONDITIONS	VALUES	UNITS
Maximum average forward current	$I_{F(AV)}$	$T_C = 100$ °C, 180° conduction half sine wave	80	A
Maximum peak one cycle non-repetitive surge current	$I_{FSM}$	10 ms sine pulse, rated $V_{RRM}$ applied	1450	
		10 ms sine pulse, no voltage reapplied	1500	
Maximum $I^2t$ for fusing	$I^2t$	10 ms sine pulse, rated $V_{RRM}$ applied	10 500	A <sup>2</sup> s
		10 ms sine pulse, no voltage reapplied	14 000	
Maximum $I^2\sqrt{t}$ for fusing	$I^2\sqrt{t}$	$t = 0.1$ ms to 10 ms, no voltage reapplied	140 000	A <sup>2</sup> √s



ELECTRICAL SPECIFICATIONS					
PARAMETER	SYMBOL	TEST CONDITIONS		VALUES	UNITS
Maximum forward voltage drop	$V_{FM}$	80 A, $T_J = 25\text{ }^\circ\text{C}$		1.17	V
Forward slope resistance	$r_f$	$T_J = 150\text{ }^\circ\text{C}$		3.17	$\text{m}\Omega$
Threshold voltage	$V_{F(TO)}$			0.73	V
Maximum reverse leakage current	$I_{RM}$	$T_J = 25\text{ }^\circ\text{C}$	$V_R = \text{Rated } V_{RRM}$	0.1	mA
		$T_J = 150\text{ }^\circ\text{C}$		1.5	

THERMAL - MECHANICAL SPECIFICATIONS				
PARAMETER	SYMBOL	TEST CONDITIONS	VALUES	UNITS
Maximum junction and storage temperature range	$T_J, T_{Stg}$		-40 to 150	$^\circ\text{C}$
Maximum thermal resistance, junction to case	$R_{thJC}$	DC operation	0.35	$^\circ\text{C}/\text{W}$
Maximum thermal resistance, junction to ambient	$R_{thJA}$		40	
Typical thermal resistance, case to heatsink	$R_{thCS}$	Mounting surface, flat, smooth and greased	0.2	
Approximate weight			6	g
			0.21	oz.
Mounting torque	minimum		6 (5)	kgf · cm (lbf · in)
	maximum		12 (10)	
Marking device		Case style TO-247AC (JEDEC)	80APS08	
			80APS12	

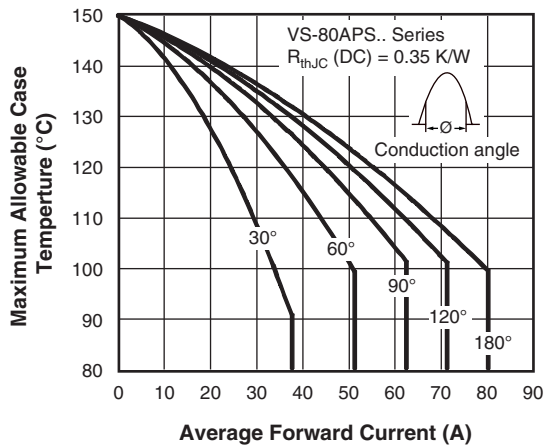

Fig. 1 - Current Rating Characteristics

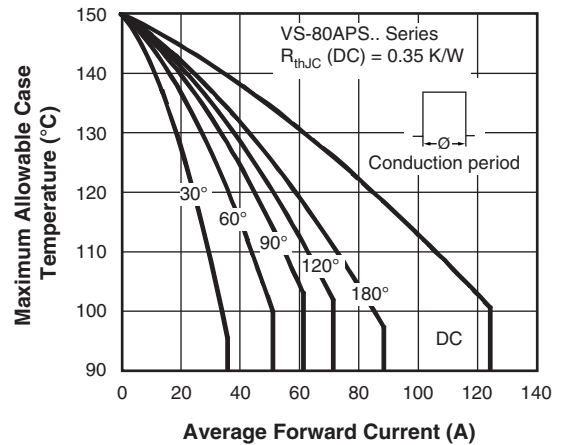

Fig. 2 - Current Rating Characteristics

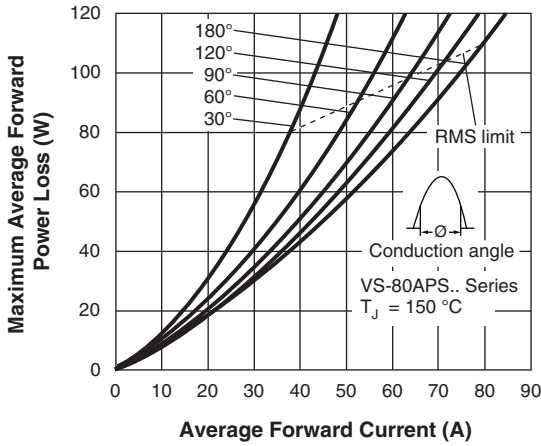

Fig. 3 - Forward Power Loss Characteristics

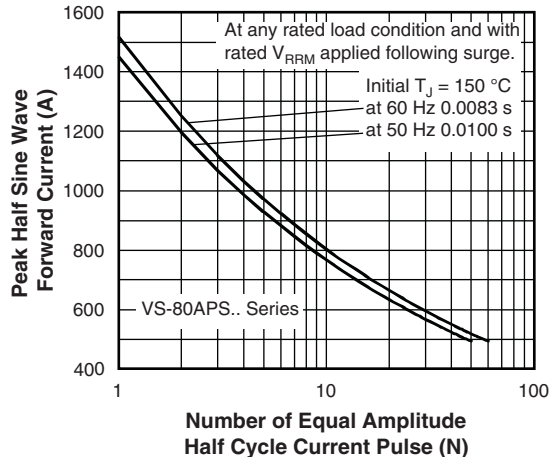

Fig. 5 - Maximum Non-Repetitive Surge Current

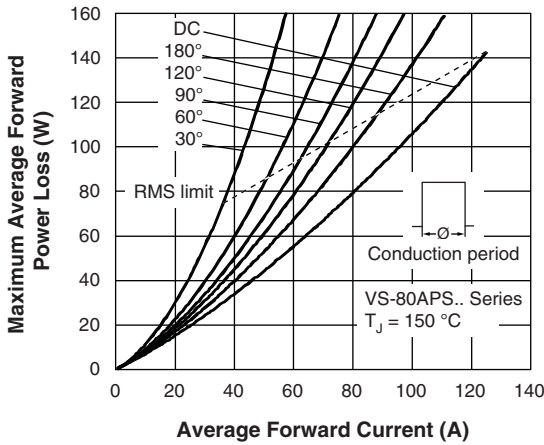

Fig. 4 - Forward Power Loss Characteristics

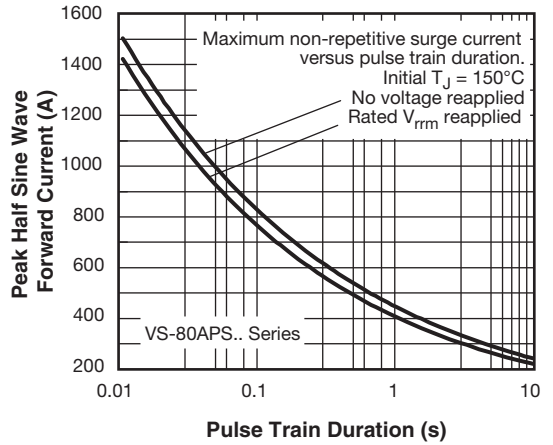

Fig. 6 - Maximum Non-Repetitive Surge Current

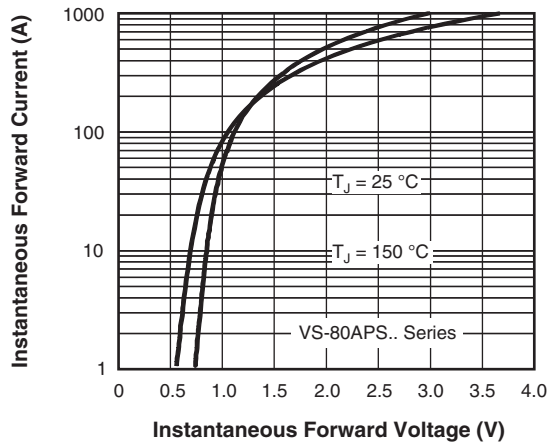

Fig. 7 - Forward Voltage Drop Characteristics

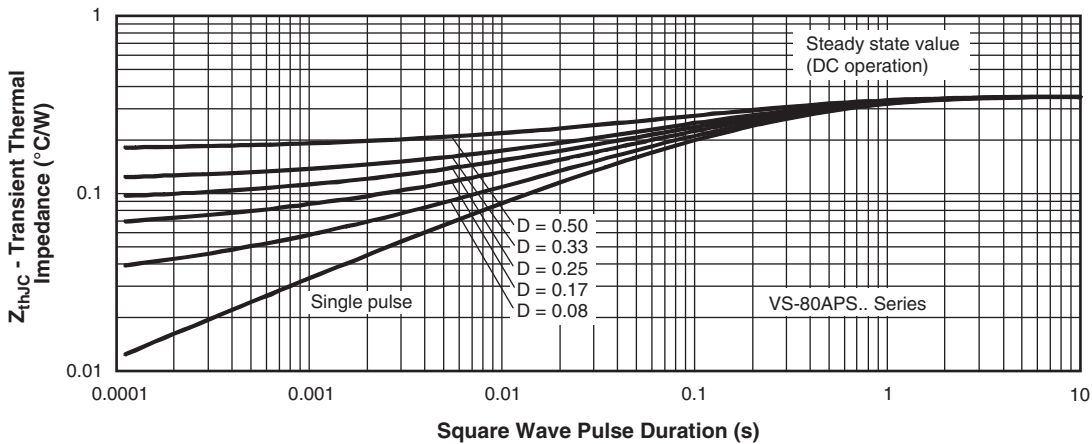

Fig. 8 - Thermal Impedance  $Z_{thJC}$  Characteristics

**ORDERING INFORMATION TABLE**

Device code	<b>VS-</b>	<b>80</b>	<b>A</b>	<b>P</b>	<b>S</b>	<b>12</b>	<b>PbF</b>
	①	②	③	④	⑤	⑥	

- 1** - Vishay Semiconductors product
- 2** - Current rating (80 = 80 A)
- 3** - Circuit configuration:  
A = Single diode, 3 pins
- 4** - Package:  
P = TO-247AC
- 5** - Type of silicon:  
S = Standard recovery rectifier
- 6** - Voltage ratings ————— 08 = 800 V  
12 = 1200 V
- 7** - Environmental digit:  
PbF = Lead (Pb)-free and RoHS compliant  
-M3 = Halogen-free, RoHS compliant and terminations lead (Pb)-free

<b>ORDERING INFORMATION (Example)</b>			
PREFERRED P/N	QUANTITY PER T/R	MINIMUM ORDER QUANTITY	PACKAGING DESCRIPTION
VS-80APS08PbF	25	500	Antistatic plastic tubes
VS-80APS08-M3	25	500	Antistatic plastic tubes
VS-80APS12PbF	25	500	Antistatic plastic tubes
VS-80APS12-M3	25	500	Antistatic plastic tubes

<b>LINKS TO RELATED DOCUMENTS</b>		
Dimensions		<a href="http://www.vishay.com/doc?95542">www.vishay.com/doc?95542</a>
Part marking information	TO-247AC modified PbF	<a href="http://www.vishay.com/doc?95226">www.vishay.com/doc?95226</a>
	TO-247AC modified -M3	<a href="http://www.vishay.com/doc?95007">www.vishay.com/doc?95007</a>
SPIICE model		<a href="http://www.vishay.com/doc?95550">www.vishay.com/doc?95550</a>



# TO-247 - 50 mils L/F

**DIMENSIONS** in millimeters and inches

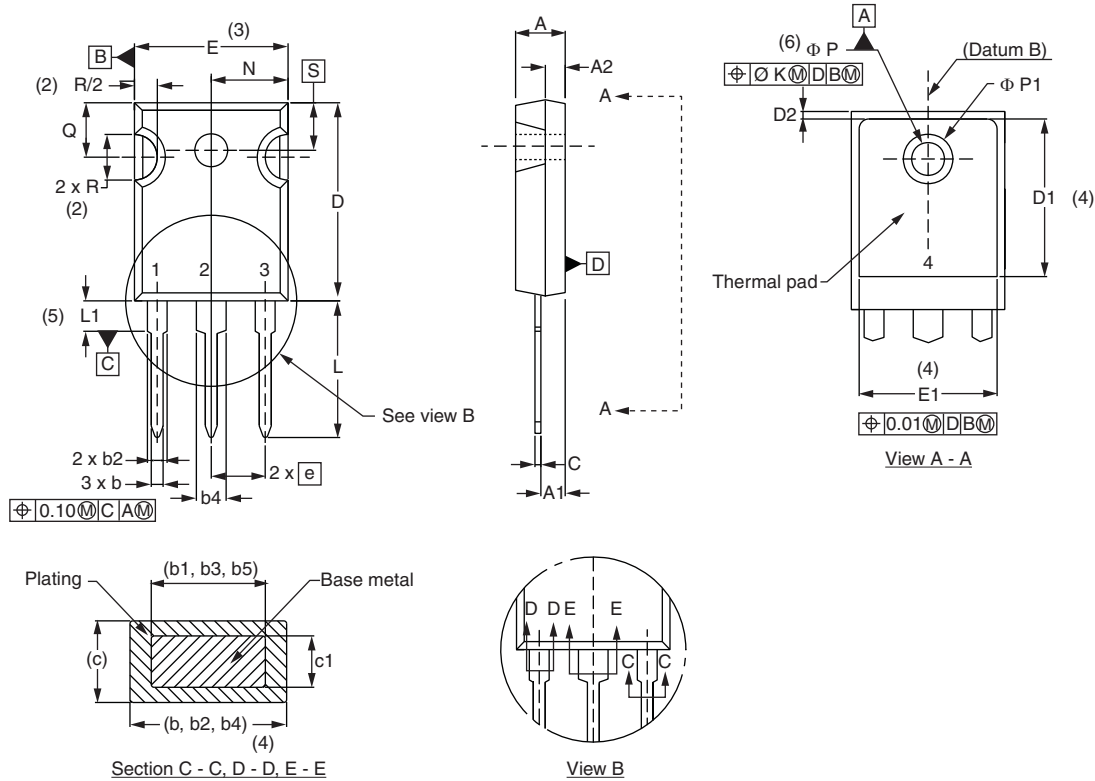

SYMBOL	MILLIMETERS		INCHES		NOTES	SYMBOL	MILLIMETERS		INCHES		NOTES
	MIN.	MAX.	MIN.	MAX.			MIN.	MAX.	MIN.	MAX.	
A	4.65	5.31	0.183	0.209		D2	0.51	1.35	0.020	0.053	
A1	2.21	2.59	0.087	0.102		E	15.29	15.87	0.602	0.625	3
A2	1.17	1.37	0.046	0.054		E1	13.46	-	0.53	-	
b	0.99	1.40	0.039	0.055		e	5.46 BSC		0.215 BSC		
b1	0.99	1.35	0.039	0.053		$\varnothing K$	0.254		0.010		
b2	1.65	2.39	0.065	0.094		L	14.20	16.10	0.559	0.634	
b3	1.65	2.34	0.065	0.092		L1	3.71	4.29	0.146	0.169	
b4	2.59	3.43	0.102	0.135		N	7.62 BSC		0.3		
b5	2.59	3.38	0.102	0.133		$\varnothing P$	3.56	3.66	0.14	0.144	
c	0.38	0.89	0.015	0.035		$\varnothing P1$	-	7.39	-	0.291	
c1	0.38	0.84	0.015	0.033		Q	5.31	5.69	0.209	0.224	
D	19.71	20.70	0.776	0.815	3	R	4.52	5.49	0.178	0.216	
D1	13.08	-	0.515	-	4	S	5.51 BSC		0.217 BSC		

**Notes**

- (1) Dimensioning and tolerancing per ASME Y14.5M-1994
- (2) Contour of slot optional
- (3) Dimension D and E do not include mold flash. Mold flash shall not exceed 0.127 mm (0.005") per side. These dimensions are measured at the outermost extremes of the plastic body
- (4) Thermal pad contour optional with dimensions D1 and E1
- (5) Lead finish uncontrolled in L1
- (6)  $\varnothing P$  to have a maximum draft angle of 1.5 to the top of the part with a maximum hole diameter of 3.91 mm (0.154")
- (7) Outline conforms to JEDEC® outline TO-247 with exception of dimension c and Q



## Disclaimer

ALL PRODUCT, PRODUCT SPECIFICATIONS AND DATA ARE SUBJECT TO CHANGE WITHOUT NOTICE TO IMPROVE RELIABILITY, FUNCTION OR DESIGN OR OTHERWISE.

Vishay Intertechnology, Inc., its affiliates, agents, and employees, and all persons acting on its or their behalf (collectively, "Vishay"), disclaim any and all liability for any errors, inaccuracies or incompleteness contained in any datasheet or in any other disclosure relating to any product.

Vishay makes no warranty, representation or guarantee regarding the suitability of the products for any particular purpose or the continuing production of any product. To the maximum extent permitted by applicable law, Vishay disclaims (i) any and all liability arising out of the application or use of any product, (ii) any and all liability, including without limitation special, consequential or incidental damages, and (iii) any and all implied warranties, including warranties of fitness for particular purpose, non-infringement and merchantability.

Statements regarding the suitability of products for certain types of applications are based on Vishay's knowledge of typical requirements that are often placed on Vishay products in generic applications. Such statements are not binding statements about the suitability of products for a particular application. It is the customer's responsibility to validate that a particular product with the properties described in the product specification is suitable for use in a particular application. Parameters provided in datasheets and/or specifications may vary in different applications and performance may vary over time. All operating parameters, including typical parameters, must be validated for each customer application by the customer's technical experts. Product specifications do not expand or otherwise modify Vishay's terms and conditions of purchase, including but not limited to the warranty expressed therein.

Except as expressly indicated in writing, Vishay products are not designed for use in medical, life-saving, or life-sustaining applications or for any other application in which the failure of the Vishay product could result in personal injury or death. Customers using or selling Vishay products not expressly indicated for use in such applications do so at their own risk. Please contact authorized Vishay personnel to obtain written terms and conditions regarding products designed for such applications.

No license, express or implied, by estoppel or otherwise, to any intellectual property rights is granted by this document or by any conduct of Vishay. Product names and markings noted herein may be trademarks of their respective owners.

## Material Category Policy

**Vishay Intertechnology, Inc. hereby certifies that all its products that are identified as RoHS-Compliant fulfill the definitions and restrictions defined under Directive 2011/65/EU of The European Parliament and of the Council of June 8, 2011 on the restriction of the use of certain hazardous substances in electrical and electronic equipment (EEE) - recast, unless otherwise specified as non-compliant.**

**Please note that some Vishay documentation may still make reference to RoHS Directive 2002/95/EC. We confirm that all the products identified as being compliant to Directive 2002/95/EC conform to Directive 2011/65/EU.**

**Vishay Intertechnology, Inc. hereby certifies that all its products that are identified as Halogen-Free follow Halogen-Free requirements as per JEDEC JS709A standards. Please note that some Vishay documentation may still make reference to the IEC 61249-2-21 definition. We confirm that all the products identified as being compliant to IEC 61249-2-21 conform to JEDEC JS709A standards.**



## Стандарт Электрон Связь

Мы молодая и активно развивающаяся компания в области поставок электронных компонентов. Мы поставляем электронные компоненты отечественного и импортного производства напрямую от производителей и с крупнейших складов мира.

Благодаря сотрудничеству с мировыми поставщиками мы осуществляем комплексные и плановые поставки широчайшего спектра электронных компонентов.

Собственная эффективная логистика и склад в обеспечивает надежную поставку продукции в точно указанные сроки по всей России.

Мы осуществляем техническую поддержку нашим клиентам и предпродажную проверку качества продукции. На все поставляемые продукты мы предоставляем гарантию .

Осуществляем поставки продукции под контролем ВП МО РФ на предприятия военно-промышленного комплекса России , а также работаем в рамках 275 ФЗ с открытием отдельных счетов в уполномоченном банке. Система менеджмента качества компании соответствует требованиям ГОСТ ISO 9001.

Минимальные сроки поставки, гибкие цены, неограниченный ассортимент и индивидуальный подход к клиентам являются основой для выстраивания долгосрочного и эффективного сотрудничества с предприятиями радиоэлектронной промышленности, предприятиями ВПК и научно-исследовательскими институтами России.

С нами вы становитесь еще успешнее!

### Наши контакты:

**Телефон:** +7 812 627 14 35

**Электронная почта:** [sales@st-electron.ru](mailto:sales@st-electron.ru)

**Адрес:** 198099, Санкт-Петербург,  
Промышленная ул, дом № 19, литера Н,  
помещение 100-Н Офис 331