

LOW POWER AND LOW OFFSET VOLTAGE SUPER SMALL-SIZED SINGLE C-MOS COMPARATOR

■GENERAL DESCRIPTION

The **NJU7108** is a super small-sized package single C-MOS comparator with push pull output.

The operating voltage is from 1V to 5.5V, and the interface can be connected with most of TTL and C-MOS type standard logic ICs.

Furthermore, The input offset voltage is lower than 4mV and Low operating current 10 μ A, therefore they can be suitable for battery use items and other portable items.

The available package is not only SC88A, but also ultra small package TSON6.

■PACKAGE INFORMATION



**NJU7108F3
(SC88A)**



**NJU7108KL1
(TSON6)**

■FEATURES

- Single Low Power Supply $V_{DD}=1.0\sim 5.5V$
- Low Offset Voltage $V_{IO}=4mV$ max
- Low Operating Current $I_{DD}=10\mu A$ typ
- Push Pull Output
- Package Outline SC88A, TSON6
- C-MOS Technology

■PIN CONFIGURATION

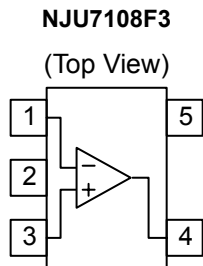

- NJU7108F3
PIN CONFIGURATION**
1. -INPUT
 2. V_{SS}
 3. +INPUT
 4. OUTPUT
 5. V_{DD}

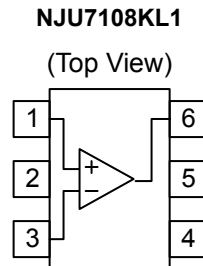

- NJU7108KL1
PIN CONFIGURATION**
1. +INPUT
 2. V_{SS}
 3. -INPUT
 4. V_{DD}
 5. V_{SS}
 6. OUTPUT

(CAUTION) There is not pin-compatible with NJU7108F3 and NJU7108KL1.

■EQUIVALENT CIRCUIT

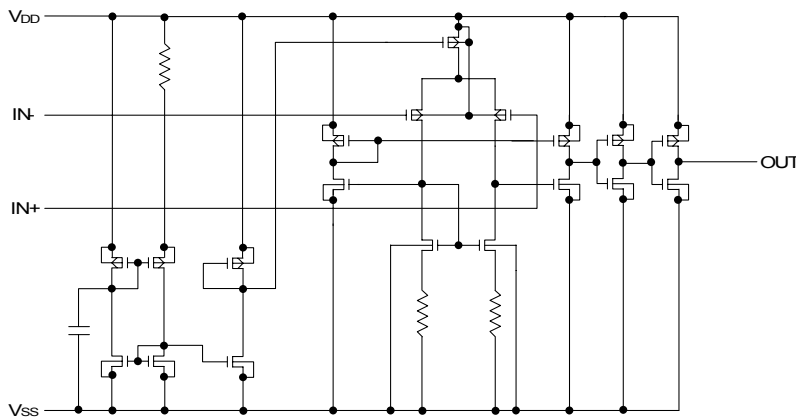

■ABSOLUTE MAXIMUM RATINGS

(Ta=25°C)

PARAMETER	SYMBOL	RATING	UNIT
Supply Voltage	V _{DD}	7.0	V
Differential Input Voltage	V _{ID}	±7.0	V
Common Mode Input Voltage	V _{IC}	-0.3~7.0 (Note1)	V
Power Dissipation	P _D	SC88A : 250 (Note2) TSON6 : 515 (Note3)	mW
Operating Temperature	T _{opr}	-40~+85	°C
Storage Temperature	T _{stg}	-55~+125	°C

(Note1) For supply voltage less than +7.0V, the absolute maximum input voltage is equal to supply voltage.

(Note2) Mounted on a glass epoxy board (FR-4) in size of 50x50x1.6mm.

(Note3) Mounted on Two layer board(40x40x1.6mm, single layer, both-side 50% share of the wiring substrate).

(Note4) Decoupling capacitor should be connected between V_{DD} and V_{SS} due to the stabilized operation for the circuit.

■ELECTRICAL CHARACTERISTICS

(V_{DD}=3.0V, R_L=∞, Ta=25°C)

PARAMETER	SYMBOL	CONDITIONS	MIN	TYP	MAX	UNIT
Operating Voltage	V _{DD}		1.0	-	5.5	V
Input Offset Voltage	V _{IO}	V _{IN} =V _{DD} /2	-	-	4	mV
Input Offset Current	I _{IO}		-	1	-	pA
Input Bias Current	I _{IB}		-	1	-	pA
Input Common Mode Voltage Range	V _{ICM}		0~2.5	-	-	V
High Level Output Voltage	V _{OH}	I _{OH} =-5mA	2.7	-	-	V
Low Level Output Voltage	V _{OL}	I _{OL} =+5mA	-	-	0.3	V
Supply Current	I _{DD}		-	10	20	uA

(V_{DD}=3.0V, f=19kHz, C_L=15pF, Ta=25°C)

PARAMETER	SYMBOL	CONDITIONS	MIN	TYP	MAX	UNIT
Propagation Delay Low to High	t _{PLH}	Over Drive=100mV	-	500	-	ns
Propagation Delay High to Low	t _{PHL}	Over Drive=100mV	-	190	-	ns
Output Signal Rising Time	t _{TLH}	Over Drive=100mV	-	10	-	ns
Output Signal Falling Time	t _{THL}	Over Drive=100mV	-	5	-	ns

■TIMING WAVEFORM

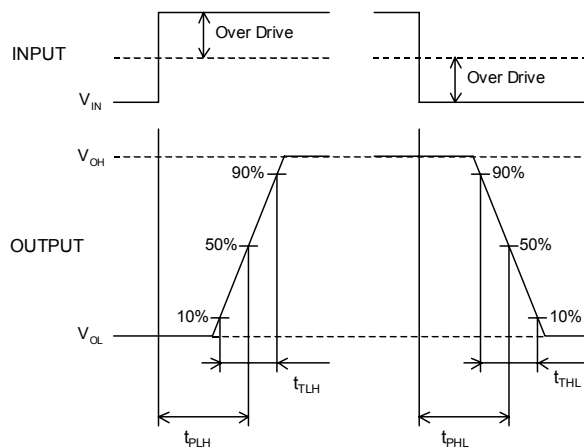

■ TYPICAL CHARACTERISTICS

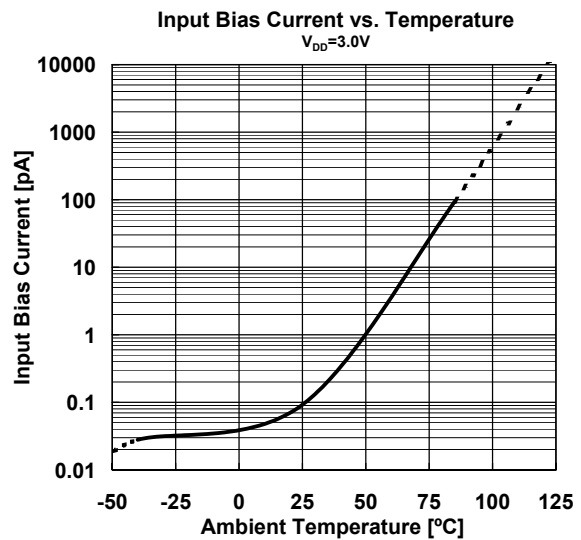
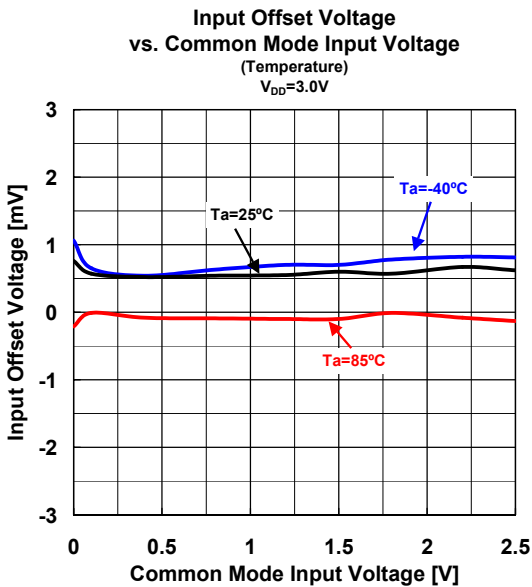
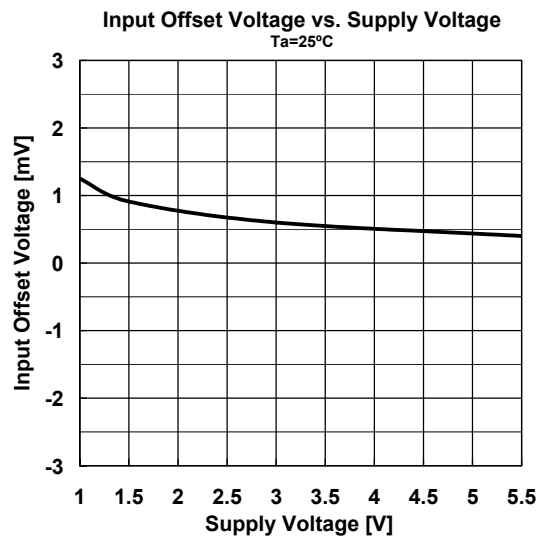
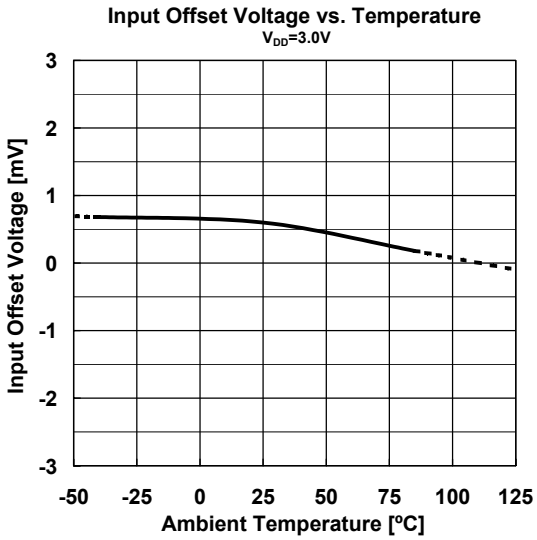
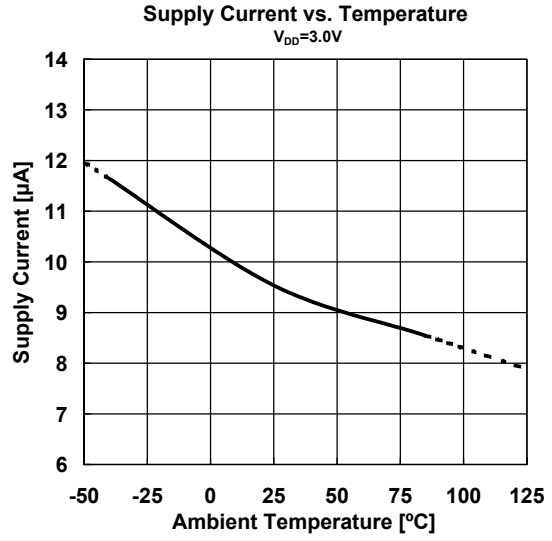
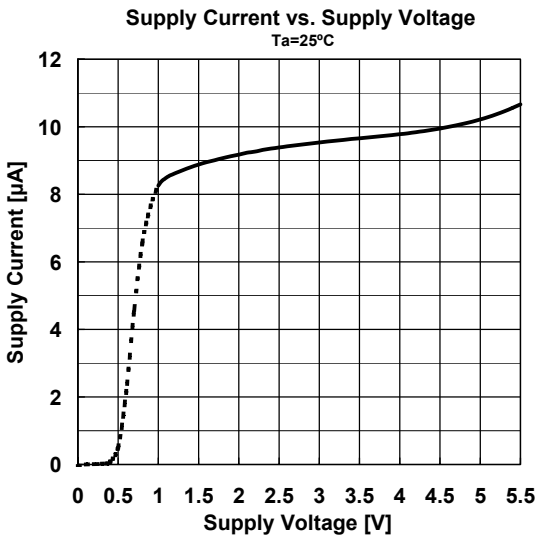

■ TYPICAL CHARACTERISTICS

High Level Output Voltage vs. Output Current
(Temperature)
 $V_{DD}=1.0V$

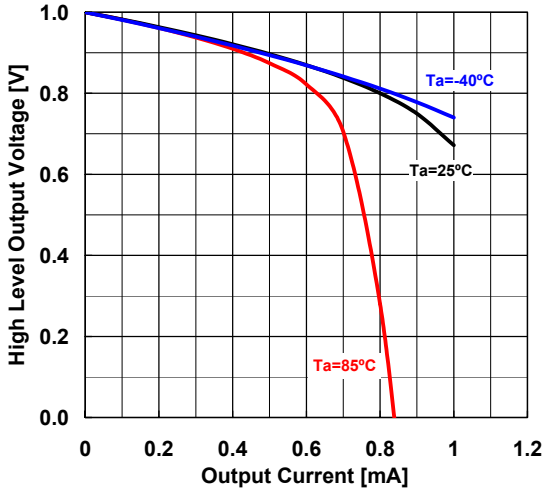

Low Level Output Voltage vs. Output Current
(Temperature)
 $V_{DD}=1.0V$

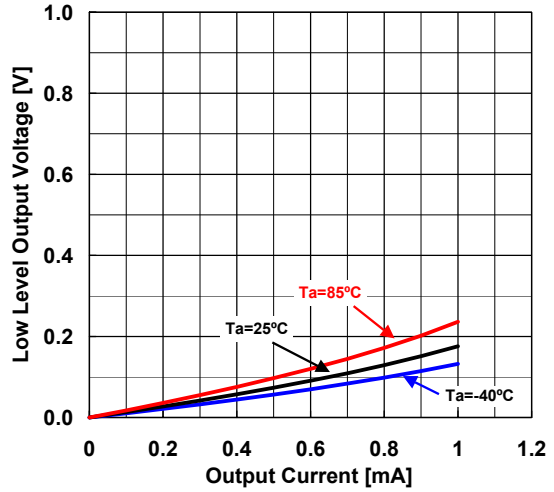

High Level Output Voltage vs. Output Current
(Temperature)
 $V_{DD}=3.0V$

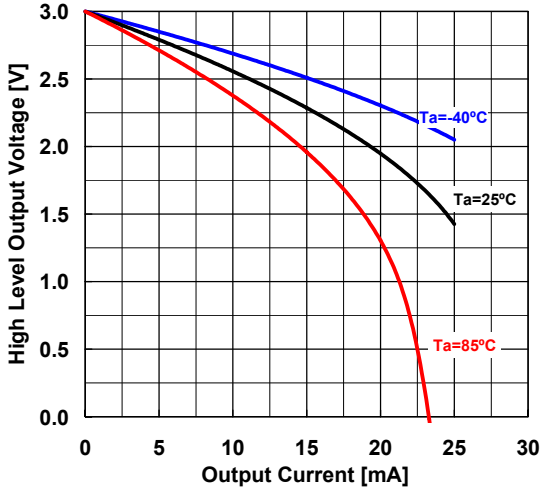

Low Level Output Voltage vs. Output Current
(Temperature)
 $V_{DD}=3.0V$

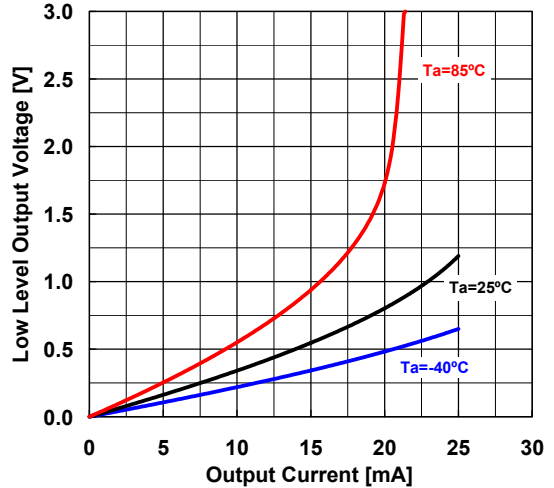

High Level Output Voltage vs. Output Current
(Temperature)
 $V_{DD}=5.5V$

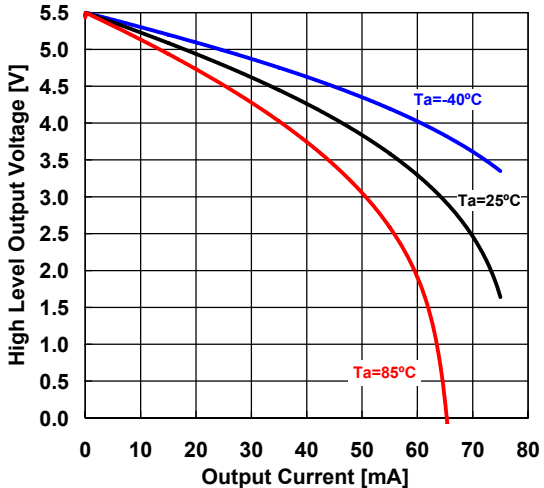

Low Level Output Voltage vs. Output Current
(Temperature)
 $V_{DD}=5.5V$

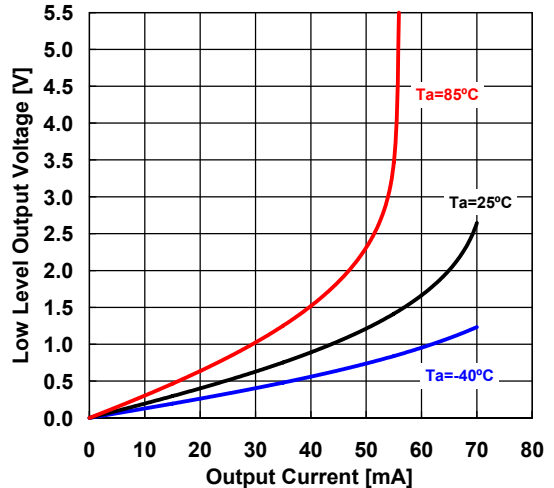

■ TYPICAL CHARACTERISTICS

Propagation Delay t_{PLH}

$V_{DD}/V_{SS} = \pm 1.5V$, Over Drive=100mV, $C_L=15pF$, $T_a=25^\circ C$

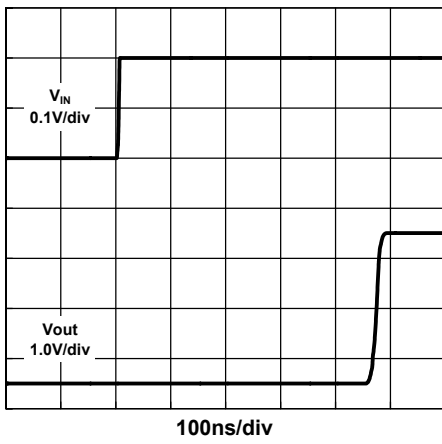

Propagation Delay t_{PHL}

$V_{DD}/V_{SS} = \pm 1.5V$, Over Drive=100mV, $C_L=15pF$, $T_a=25^\circ C$

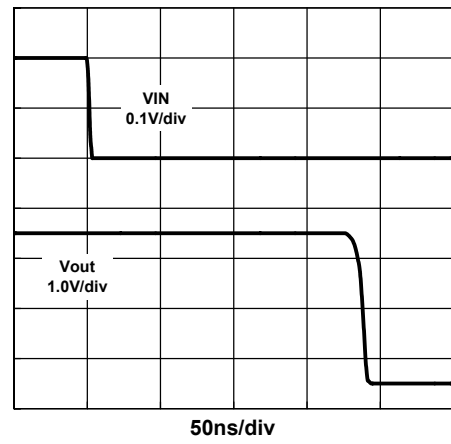

Propagation Delay vs. Temperature

$V_{DD}/V_{SS} = \pm 1.5V$, $V_{IN} = 200mV_{pp}$, Over Drive=100mV, $C_L=15pF$

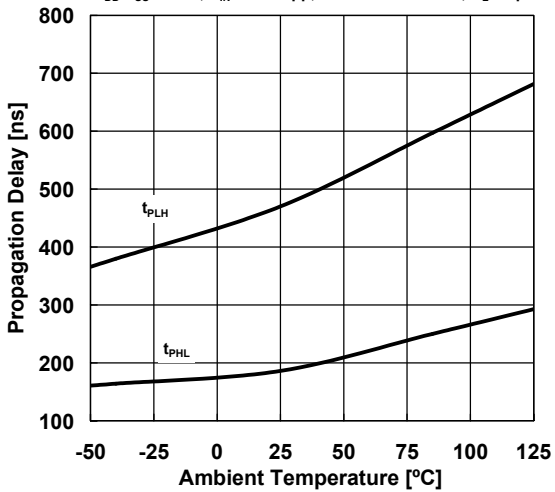

Propagation Delay vs. Supply Voltage

$V_{IN} = 200mV_{pp}$, Over Drive=100mV, $C_L=15pF$, $T_a=25^\circ C$

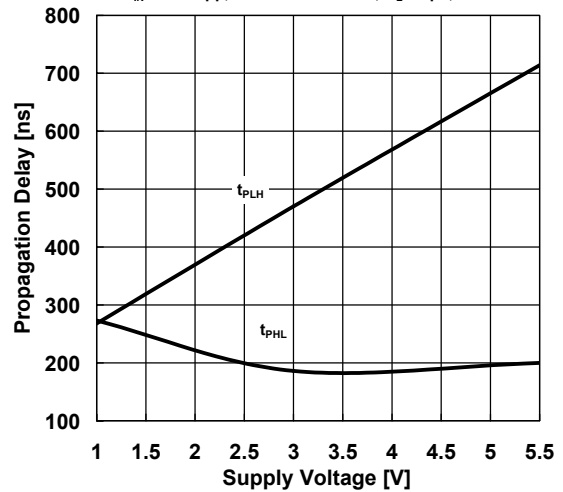

■ TEST CIRCUIT

Switching Characteristics Measurement Circuit

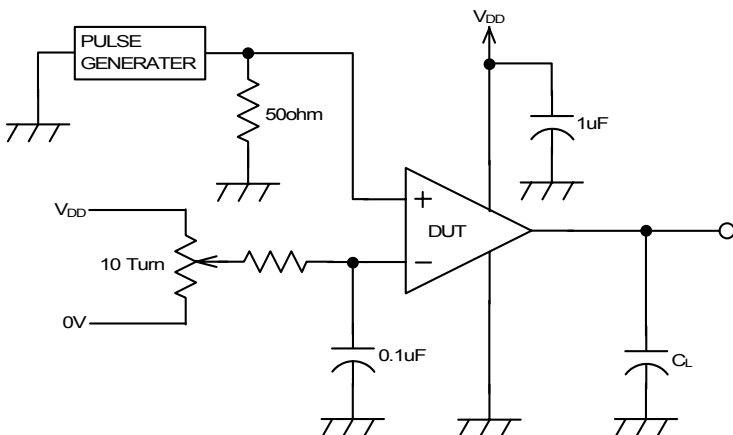

■ PACKAGE DIMENSIONS

SC88A

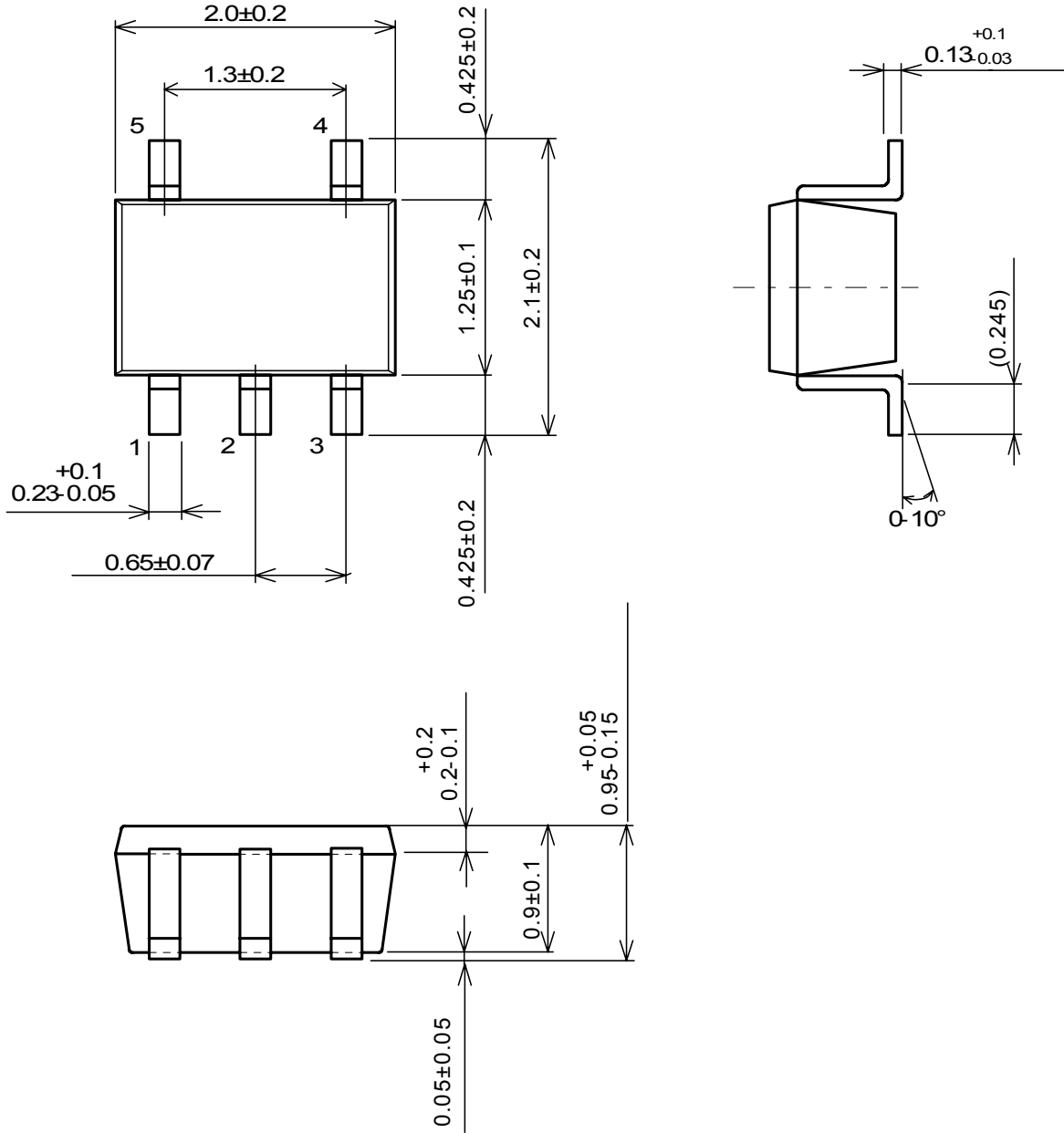

■PACKAGE DIMENSIONS

TS0N6

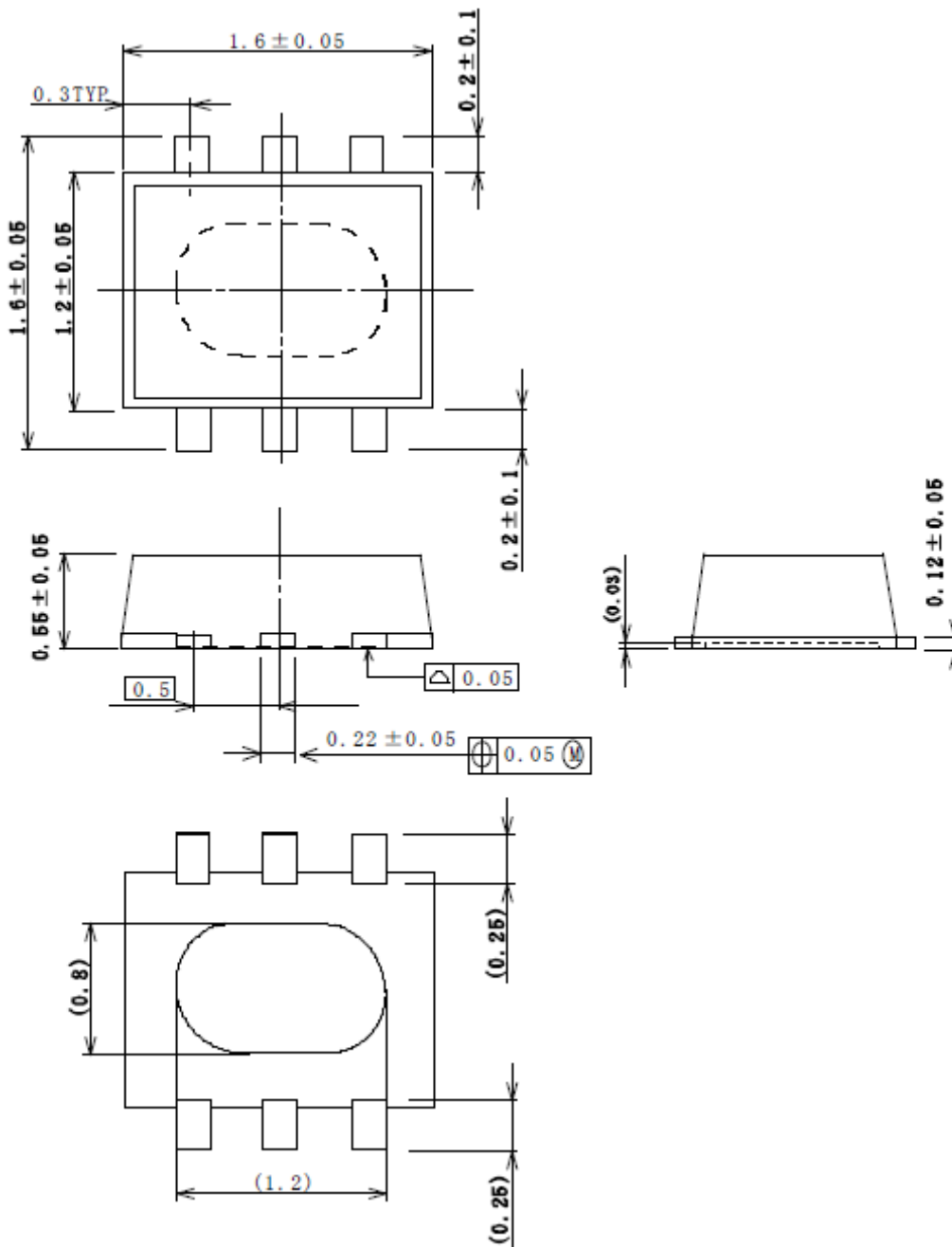

[CAUTION]
 The specifications on this data book are only given for information, without any guarantee as regards either mistakes or omissions. The application circuits in this data book are described only to show representative usages of the product and not intended for the guarantee or permission of any right including the industrial rights.

Mouser Electronics

Authorized Distributor

Click to View Pricing, Inventory, Delivery & Lifecycle Information:

[NJR:](#)

[NJU7108F3-TE2](#) [NJU7108F3-TE1](#)



Стандарт Электрон Связь

Мы молодая и активно развивающаяся компания в области поставок электронных компонентов. Мы поставляем электронные компоненты отечественного и импортного производства напрямую от производителей и с крупнейших складов мира.

Благодаря сотрудничеству с мировыми поставщиками мы осуществляем комплексные и плановые поставки широчайшего спектра электронных компонентов.

Собственная эффективная логистика и склад в обеспечивает надежную поставку продукции в точно указанные сроки по всей России.

Мы осуществляем техническую поддержку нашим клиентам и предпродажную проверку качества продукции. На все поставляемые продукты мы предоставляем гарантию .

Осуществляем поставки продукции под контролем ВП МО РФ на предприятия военно-промышленного комплекса России , а также работаем в рамках 275 ФЗ с открытием отдельных счетов в уполномоченном банке. Система менеджмента качества компании соответствует требованиям ГОСТ ISO 9001.

Минимальные сроки поставки, гибкие цены, неограниченный ассортимент и индивидуальный подход к клиентам являются основой для выстраивания долгосрочного и эффективного сотрудничества с предприятиями радиоэлектронной промышленности, предприятиями ВПК и научно-исследовательскими институтами России.

С нами вы становитесь еще успешнее!

Наши контакты:

Телефон: +7 812 627 14 35

Электронная почта: sales@st-electron.ru

Адрес: 198099, Санкт-Петербург,
Промышленная ул, дом № 19, литера Н,
помещение 100-Н Офис 331