

**IGBT/SiC Diode Co-pack**

$V_{CES}$	=	<b>1200 V</b>
$I_{CM}$	=	<b>100 A</b>
$V_{CE(SAT)}$	=	<b>1.9 V</b>

**Features**

- Optimal Punch Through (OPT) technology
- SiC freewheeling diode
- Positive temperature coefficient for easy paralleling
- Extremely fast switching speeds
- Temperature independent switching behavior of SiC rectifier
- Best RBSOA/SCSOA capability in the industry
- High junction temperature
- Industry standard packaging

**Package**

- RoHS Compliant

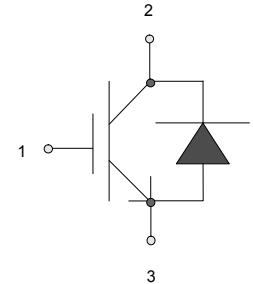
**SOT – 227**
**Advantages**

- Industry's highest switching speeds
- High temperature operation
- Improved circuit efficiency
- Low switching losses

**Applications**

- Solar Inverters
- Aerospace Actuators
- Server Power Supplies
- Resonant Inverters > 100 kHz
- Inductive Heating
- Electronic Welders

**Maximum Ratings at  $T_j = 175\text{ }^\circ\text{C}$ , unless otherwise specified**

Parameter	Symbol	Conditions	Values	Unit
<b>IGBT</b>				
Collector-Emitter Voltage	$V_{CES}$		1200	V
DC-Collector Current	$I_C$	$T_C \leq 130\text{ }^\circ\text{C}$	100	A
Peak Collector Current	$I_{CM}$	Limited by $T_{vjmax}$	200	A
Gate Emitter Peak Voltage	$V_{GES}$		$\pm 20$	V
IGBT Short Circuit SOA	$t_{psc}$	$V_{CC} = 900\text{ V}$ , $V_{CEM} \leq 1200\text{ V}$ $V_{GE} \leq 15\text{ V}$ , $T_{vj} \leq 125\text{ }^\circ\text{C}$	10	$\mu\text{s}$
Operating Temperature	$T_{vj}$		-40 to +175	$^\circ\text{C}$
Storage Temperature	$T_{stg}$		-40 to +175	$^\circ\text{C}$
Isolation Voltage	$V_{ISOL}$	$I_{SOL} < 1\text{ mA}$ , 50/60 Hz, $t = 1\text{ s}$	3000	V

**Free-wheeling Silicon Carbide diode**

DC-Forward Current	$I_F$	$T_C \leq 130\text{ }^\circ\text{C}$	100	A
Non Repetitive Peak Forward Current	$I_{FM}$	$T_C = 25\text{ }^\circ\text{C}$ , $t_p = 10\text{ }\mu\text{s}$	tbd	A
Surge Non Repetitive Forward Current	$I_{F,SM}$	$t_p = 10\text{ ms}$ , half sine, $T_C = 25\text{ }^\circ\text{C}$	tbd	A

**Thermal Characteristics**

Thermal resistance, junction - case	$R_{thJC}$	IGBT	0.08	$^\circ\text{C/W}$
Thermal resistance, junction - case	$R_{thJC}$	SiC Diode	0.53	$^\circ\text{C/W}$

**Mechanical Properties**

	Symbol	Values		
		min.	typ.	max.
Mounting Torque	$M_d$		1.5	Nm
Terminal Connection Torque		1.3		Nm
Weight			29	g
Case Color		Black		
Dimensions		38 x 25.4 x 12 mm		

**Electrical Characteristics at  $T_j = 175\text{ }^\circ\text{C}$ , unless otherwise specified**

Parameter	Symbol	Conditions	Values			Unit
			min.	typ.	max.	
<b>IGBT</b>						
Gate Threshold Voltage	$V_{GE(th)}$	$V_{GE} = V_{CE}, I_C = 4\text{ mA}, T_j = 25\text{ }^\circ\text{C}$	5	6.2	7	V
Collector-Emitter Leakage Current	$I_{CES,25}$	$V_{GE} = 0\text{ V}, V_{CE} = V_{CES}, T_j = 25\text{ }^\circ\text{C}$		0.10	1	mA
	$I_{CES,175}$	$V_{GE} = 0\text{ V}, V_{CE} = V_{CES}, T_j = 175\text{ }^\circ\text{C}$		3.15		mA
Gate-Leakage Current	$I_{GES}$	$V_{CE} = 0\text{ V}, V_{GE} = 20\text{ V}, T_j = 175\text{ }^\circ\text{C}$	-400		400	nA
Collector-Emitter Threshold Voltage	$V_{GE(TO)}$	$T_j = 25\text{ }^\circ\text{C}$		1.1		V
Collector-Emitter Slope Resistance	$R_{CE,25}$	$V_{GE} = 15\text{ V}, T_j = 25\text{ }^\circ\text{C}$		7.9		m $\Omega$
	$R_{CE,175}$	$V_{GE} = 15\text{ V}, T_j = 175\text{ }^\circ\text{C}$		11.4		m $\Omega$
Collector-Emitter Saturation Voltage	$V_{CE(SAT)}$	$I_C = 100\text{ A}, V_{GE} = 15\text{ V}, T_j = 25\text{ }^\circ\text{C} (175\text{ }^\circ\text{C})$		1.9 (2.2)		V
Input Capacitance	$C_{ies}$	$V_{GE} = 0\text{ V}, V_{CE} = 25\text{ V}, f = 1\text{ MHz}, T_j = 150\text{ }^\circ\text{C}$		8.55		nF
Output Capacitance	$C_{oes}$			1.39		nF
Reverse Transfer Capacitance	$C_{res}$			0.25		nF
Internal Gate Resistance	$R_{Gint}$			2		$\Omega$
Gate Charge	$Q_G$	$V_{CC} = 750\text{ V}, I_C = 100\text{ A}, V_{GE} = -8..15\text{ V}, T_j = 25\text{ }^\circ\text{C} (125\text{ }^\circ\text{C})$		900 (900)		nC
Module Lead Resistance	$R_{mod}$	$T_c = 25\text{ }^\circ\text{C} (175\text{ }^\circ\text{C})$		tbid		m $\Omega$
Reverse Bias Safe Operating Area	RBSOA	$T_j = 175\text{ }^\circ\text{C}, R_{\theta} = 56\text{ }^\circ\text{C/W}, V_{CC} = 1200\text{ V}, V_{GE} = 15\text{ V}$		150		A
Short Circuit Current	$I_{sc}$	$T_j = 175\text{ }^\circ\text{C}, R_{\theta} = 56\text{ }^\circ\text{C/W}, V_{CC} = 900\text{ V}, V_{GE} = \pm 15\text{ V}$		470		A
Short Circuit Duration	$t_{sc}$				10	
Rise Time	$t_r$	$V_{CC} = 800\text{ V}, I_C = 100\text{ A}, R_{gon} = R_{goff} = 10\text{ }^\circ\Omega, V_{GE(on)} = 15\text{ V}, V_{GE(off)} = -8\text{ V}, L_S = 0.8\text{ }^\mu\text{H}, T_j = 25\text{ }^\circ\text{C}$		254		ns
Fall Time	$t_f$			153		ns
Turn On Delay Time	$t_{d(on)}$			244		ns
Turn Off Delay Time	$t_{d(off)}$			488		ns
Turn-On Energy Loss Per Pulse	$E_{on}$			14.2		mJ
Turn-Off Energy Loss Per Pulse	$E_{off}$			15.7		mJ
Rise Time	$t_r$	$V_{CC} = 800\text{ V}, I_C = 100\text{ A}, R_{gon} = R_{goff} = 10\text{ }^\circ\Omega, V_{GE(on)} = 15\text{ V}, V_{GE(off)} = -8\text{ V}, L_S = 0.8\text{ }^\mu\text{H}, T_j = 175\text{ }^\circ\text{C}$		211		ns
Fall Time	$t_f$			172		ns
Turn On Delay Time	$t_{d(on)}$			240		ns
Turn Off Delay Time	$t_{d(off)}$			636		ns
Turn-On Energy Loss Per Pulse	$E_{on}$			11.1		mJ
Turn-Off Energy Loss Per Pulse	$E_{off}$			21.8		mJ
<b>Free-wheeling Silicon Carbide Diode</b>						
Forward Voltage	$V_F$	$I_F = 100\text{ A}, V_{GE} = 0\text{ V}, T_j = 25\text{ }^\circ\text{C} (175\text{ }^\circ\text{C})$		2.08 (3.5)		V
Threshold Voltage at Diode	$V_{D(TO)}$	$T_j = 25\text{ }^\circ\text{C}$		0.8		V
Peak Reverse Recovery Current	$I_{rrm}$	$I_F = 100\text{ A}, V_{GE} = 0\text{ V}, V_R = 800\text{ V}, -di_F/dt = 625\text{ A}/\mu\text{s}, T_j = 175\text{ }^\circ\text{C}$		10		A
Reverse Recovery Time	$t_{rr}$			100		ns
Rise Time	$t_r$	$V_{CC} = 800\text{ V}, I_C = 100\text{ A}, R_{gon} = R_{goff} = 10\text{ }^\circ\Omega, V_{GE(on)} = 15\text{ V}, V_{GE(off)} = -8\text{ V}, L_S = 0.8\text{ }^\mu\text{H}, T_j = 25\text{ }^\circ\text{C}$		148		ns
Fall Time	$t_f$			336		ns
Turn-On Energy Loss Per Pulse	$E_{on}$			218		$\mu\text{J}$
Turn-Off Energy Loss Per Pulse	$E_{off}$			113		$\mu\text{J}$
Reverse Recovery Charge	$Q_{rr}$			730		nC
Rise Time	$t_r$			178		ns
Fall Time	$t_f$	$V_{CC} = 800\text{ V}, I_C = 100\text{ A}, R_{gon} = R_{goff} = 10\text{ }^\circ\Omega, V_{GE(on)} = 15\text{ V}, V_{GE(off)} = -8\text{ V}, L_S = 0.8\text{ }^\mu\text{H}, T_j = 175\text{ }^\circ\text{C}$		268		ns
Turn-On Energy Loss Per Pulse	$E_{on}$			23		$\mu\text{J}$
Turn-Off Energy Loss Per Pulse	$E_{off}$			334		$\mu\text{J}$
Reverse Recovery Charge	$Q_{rr}$			480		nC

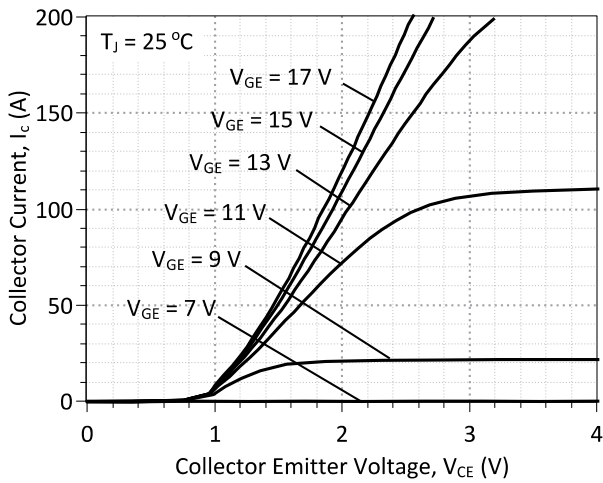

**Figure 1: Typical Output Characteristics at 25 °C**

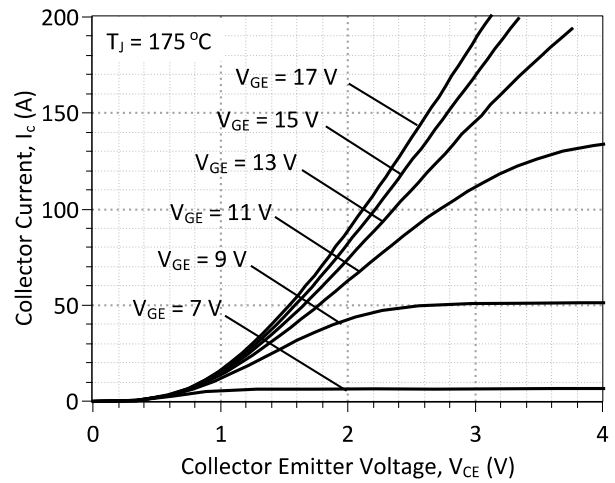

**Figure 2: Typical Output Characteristics at 175 °C**

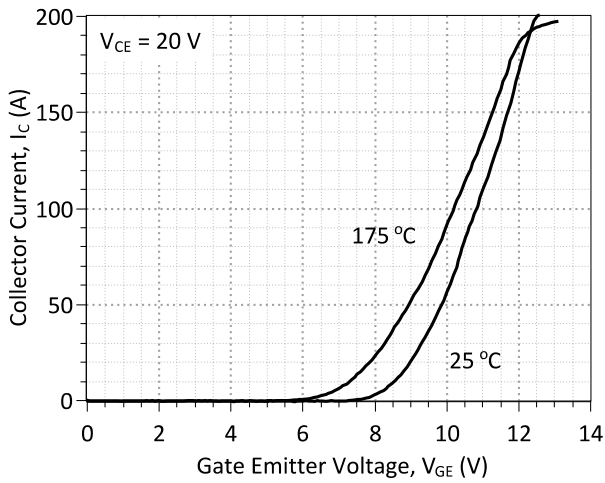

**Figure 3: Typical Transfer Characteristics**

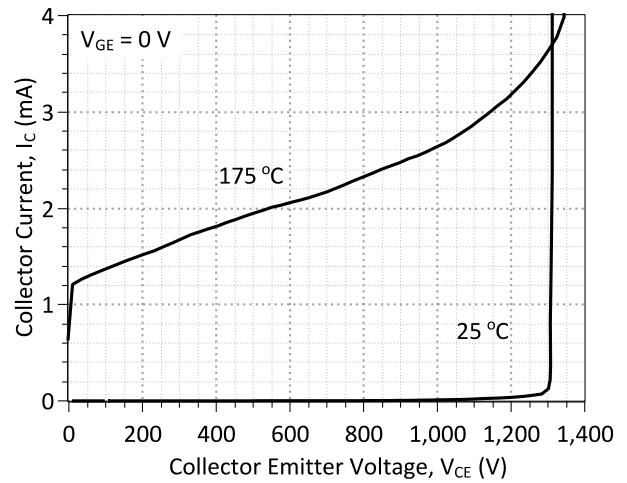

**Figure 4: Typical Blocking Characteristics**

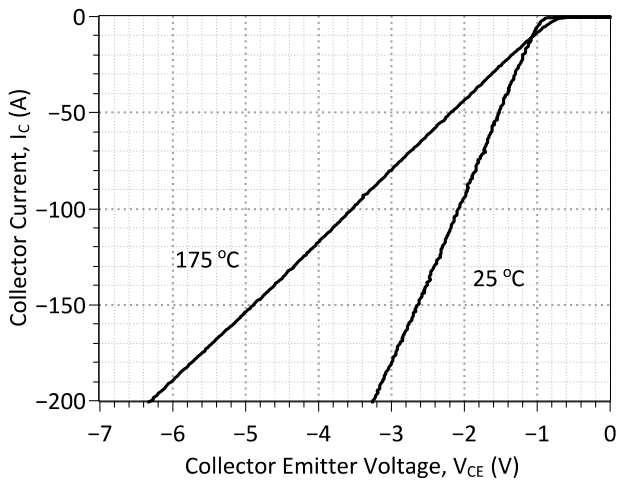

**Figure 5: Typical FWD Forward Characteristics**

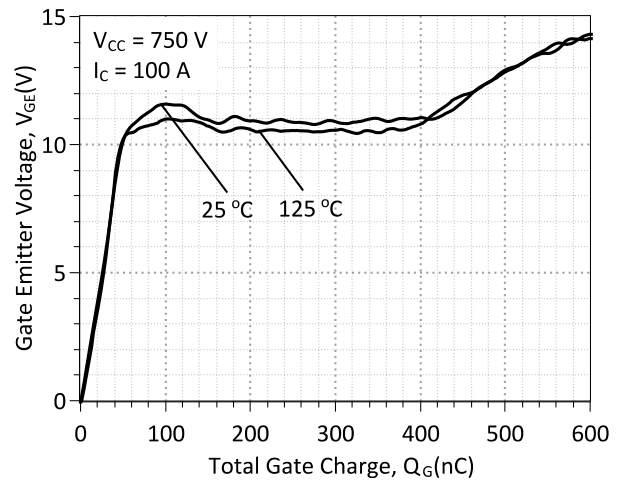

**Figure 6: Typical Turn On Gate Charge**

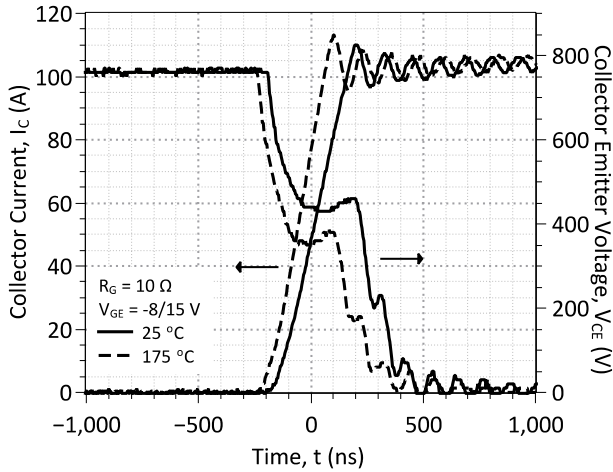

**Figure 7: Typical Hard-Switched IGBT Turn On Waveforms**

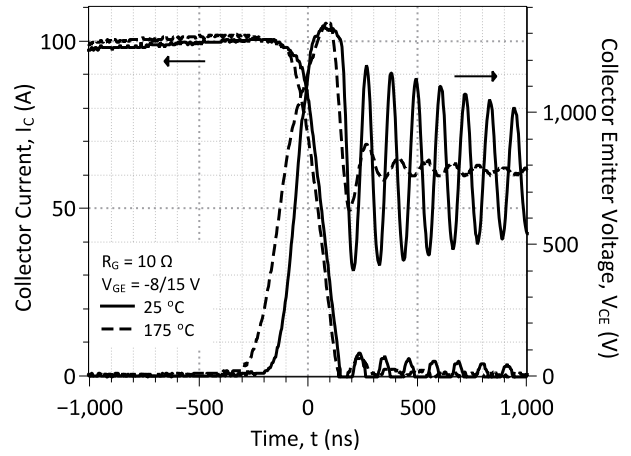

**Figure 8: Typical Hard-Switched IGBT Turn Off Waveforms**

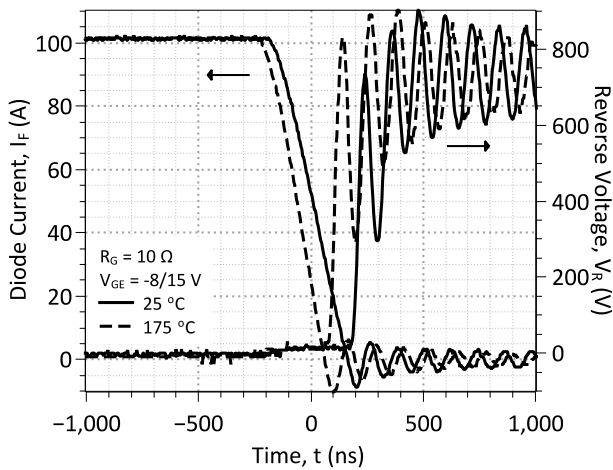

**Figure 9: Typical Hard-Switched Free-wheeling SiC Diode Turn Off Waveforms**

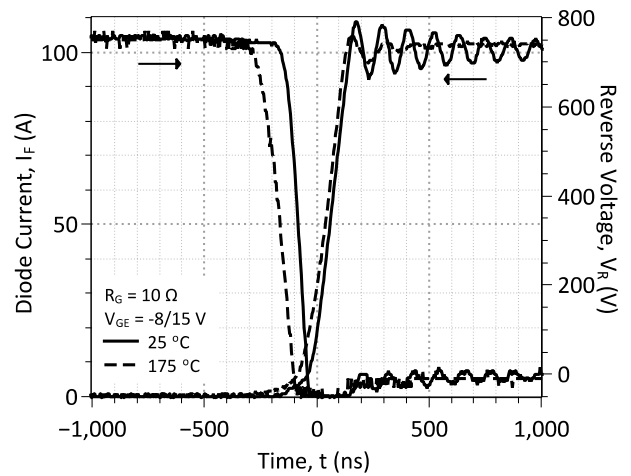

**Figure 10: Typical Hard-Switched Free-wheeling SiC Diode Turn On Waveforms**

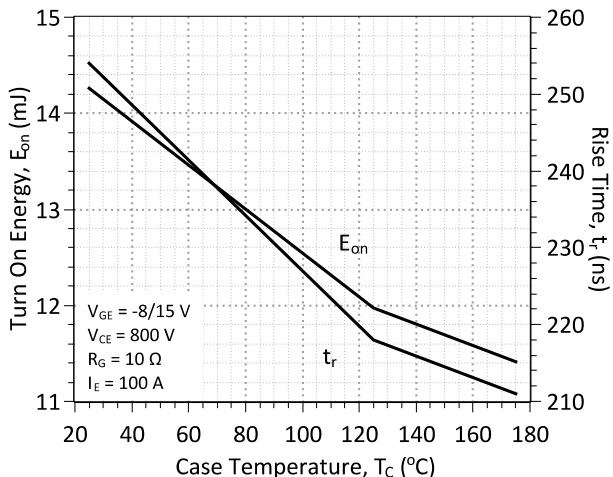

**Figure 11: Typical Module Energy Losses and Switching Times at IGBT Turn On vs. Temperature**

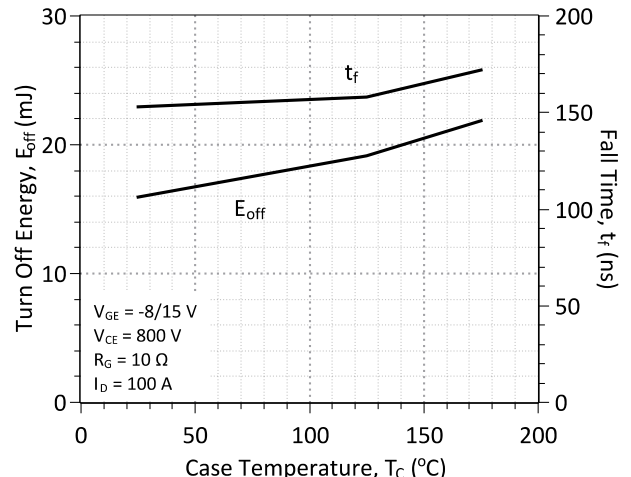

**Figure 12: Typical Module Energy Losses and Switching Times at IGBT Turn Off vs. Temperature**

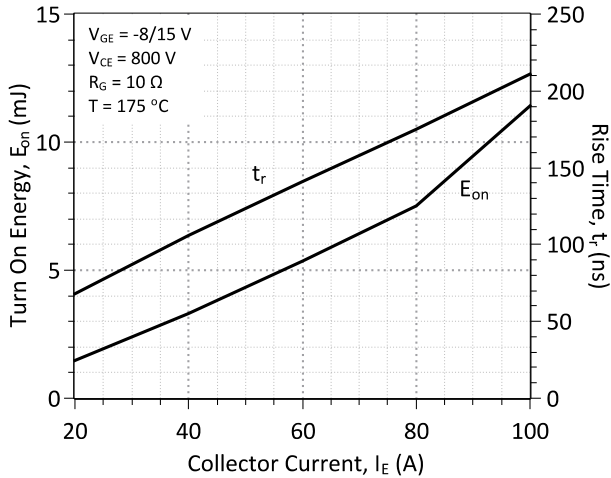

**Figure 13: Typical Module Energy Losses and Switching Times at IGBT Turn On vs. Current**

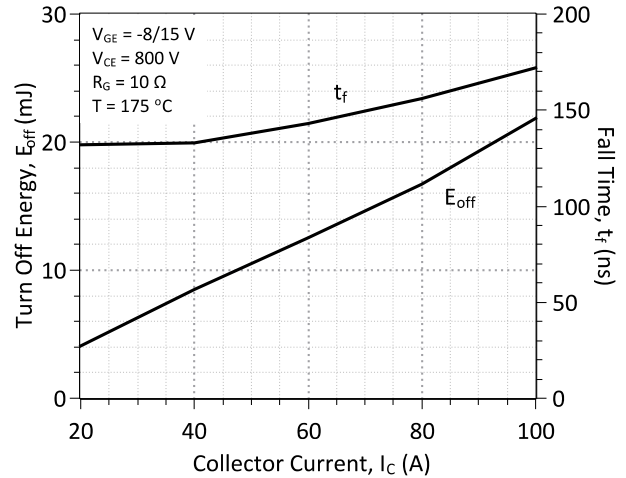

**Figure 14: Typical Module Energy Losses and Switching Times at IGBT Turn Off vs. Current**

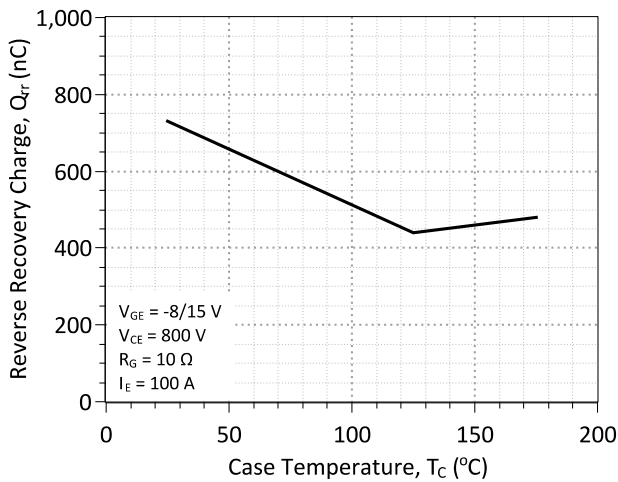

**Figure 15: Typical Hard-Switched Reverse Recovery Charge vs. Temperature**

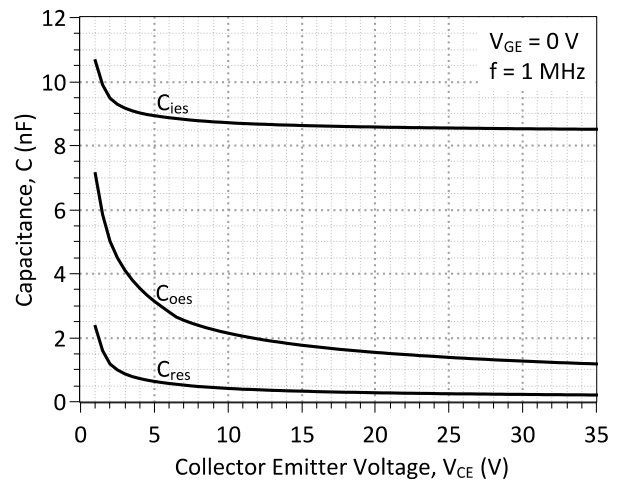

**Figure 16: Typical C-V Characteristics**

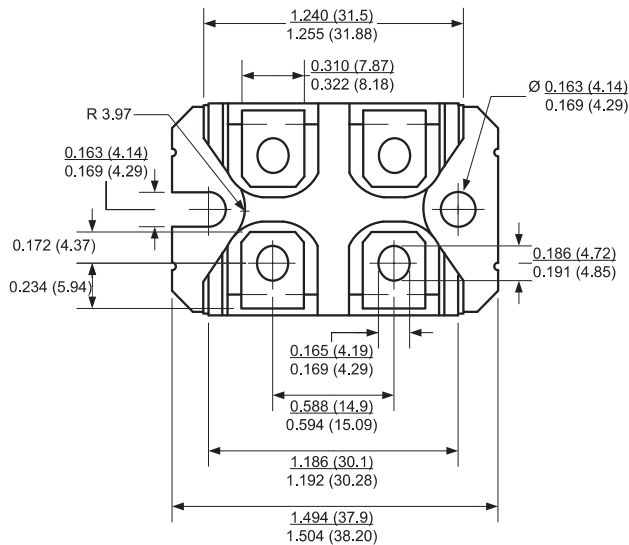
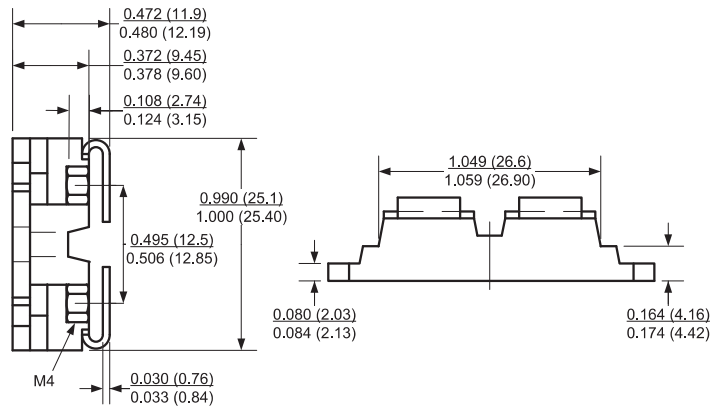
**Package Dimensions:**
**SOT-227**

**PACKAGE OUTLINE**

**NOTE**

1. CONTROLLED DIMENSION IS INCH. DIMENSION IN BRACKET IS MILLIMETER.
2. DIMENSIONS DO NOT INCLUDE END FLASH, MOLD FLASH, MATERIAL PROTRUSIONS

Revision History			
Date	Revision	Comments	Supersedes
2013/02/08	2	Updated Electrical Characteristics	
2012/07/30	1	Second generation release	GA100XCP12-227
2011/01/06	0	Initial release	

Published by  
 GeneSiC Semiconductor, Inc.  
 43670 Trade Center Place Suite 155  
 Dulles, VA 20166

GeneSiC Semiconductor, Inc. reserves right to make changes to the product specifications and data in this document without notice.

GeneSiC disclaims all and any warranty and liability arising out of use or application of any product. No license, express or implied to any intellectual property rights is granted by this document.

Unless otherwise expressly indicated, GeneSiC products are not designed, tested or authorized for use in life-saving, medical, aircraft navigation, communication, air traffic control and weapons systems, nor in applications where their failure may result in death, personal injury and/or property damage.



## Стандарт Электрон Связь

Мы молодая и активно развивающаяся компания в области поставок электронных компонентов. Мы поставляем электронные компоненты отечественного и импортного производства напрямую от производителей и с крупнейших складов мира.

Благодаря сотрудничеству с мировыми поставщиками мы осуществляем комплексные и плановые поставки широчайшего спектра электронных компонентов.

Собственная эффективная логистика и склад в обеспечивает надежную поставку продукции в точно указанные сроки по всей России.

Мы осуществляем техническую поддержку нашим клиентам и предпродажную проверку качества продукции. На все поставляемые продукты мы предоставляем гарантию .

Осуществляем поставки продукции под контролем ВП МО РФ на предприятия военно-промышленного комплекса России , а также работаем в рамках 275 ФЗ с открытием отдельных счетов в уполномоченном банке. Система менеджмента качества компании соответствует требованиям ГОСТ ISO 9001.

Минимальные сроки поставки, гибкие цены, неограниченный ассортимент и индивидуальный подход к клиентам являются основой для выстраивания долгосрочного и эффективного сотрудничества с предприятиями радиоэлектронной промышленности, предприятиями ВПК и научно-исследовательскими институтами России.

С нами вы становитесь еще успешнее!

### Наши контакты:

**Телефон:** +7 812 627 14 35

**Электронная почта:** [sales@st-electron.ru](mailto:sales@st-electron.ru)

**Адрес:** 198099, Санкт-Петербург,  
Промышленная ул, дом № 19, литера Н,  
помещение 100-Н Офис 331