

**Low Loss DuoPack : IGBT in TrenchStop® and Fieldstop technology
 with soft, fast recovery anti-parallel EmCon HE diode**

 Very low $V_{CE(sat)}$ 1.5 V (typ.)

- Maximum Junction Temperature 175 °C
- Short circuit withstand time – 5µs
- Designed for :
 - Frequency Converters
 - Drives
- TrenchStop® and Fieldstop technology for 600 V applications offers :
 - very tight parameter distribution
 - high ruggedness, temperature stable behavior
 - very high switching speed
 - low $V_{CE(sat)}$
- Positive temperature coefficient in $V_{CE(sat)}$
- Low EMI
- Low Gate Charge
- Very soft, fast recovery anti-parallel EmCon HE diode
- Qualified according to JEDEC¹ for target applications
- Pb-free lead plating; RoHS compliant
- Complete product spectrum and PSpice Models : <http://www.infineon.com/igbt/>

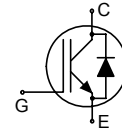

Type	V_{CE}	I_C	$V_{CE(sat), T_j=25^\circ C}$	$T_{j,max}$	Marking	Package
IKP04N60T	600 V	4 A	1.5 V	175 °C	K04T60	PG-TO-220-3-1
IKI04N60T	600 V	4 A	1.5 V	175 °C	K04T60	PG-TO-262-3

Maximum Ratings

Parameter	Symbol	Value	Unit
Collector-emitter voltage	V_{CE}	600	V
DC collector current, limited by $T_{j,max}$ $T_C = 25^\circ C$ $T_C = 100^\circ C$	I_C	8 4	A
Pulsed collector current, t_p limited by $T_{j,max}$	$I_{C,puls}$	12	
Turn off safe operating area ($V_{CE} \leq 600V, T_j \leq 175^\circ C$)	-	12	
Diode forward current, limited by $T_{j,max}$ $T_C = 25^\circ C$ $T_C = 100^\circ C$	I_F	8 4	
Diode pulsed current, t_p limited by $T_{j,max}$	$I_{F,puls}$	12	
Gate-emitter voltage	V_{GE}	± 20	V
Short circuit withstand time ²⁾ $V_{GE} = 15V, V_{CC} \leq 400V, T_j \leq 150^\circ C$	t_{SC}	5	µs
Power dissipation $T_C = 25^\circ C$	P_{tot}	42	W
Operating junction temperature	T_j	-40...+175	°C
Storage temperature	T_{stg}	-55...+175	
Soldering temperature, 1.6mm (0.063 in.) from case for 10s	-	260	

¹ J-STD-020 and JEDEC-022

²⁾ Allowed number of short circuits: <1000; time between short circuits: >1s.

Thermal Resistance

Parameter	Symbol	Conditions	Max. Value	Unit
Characteristic				
IGBT thermal resistance, junction – case	R_{thJC}		3.5	K/W
Diode thermal resistance, junction – case	R_{thJCD}		5	
Thermal resistance, junction – ambient	R_{thJA}		62	

Electrical Characteristic, at $T_j = 25^\circ\text{C}$, unless otherwise specified

Parameter	Symbol	Conditions	Value			Unit
			min.	Typ.	max.	
Static Characteristic						
Collector-emitter breakdown voltage	$V_{(BR)CES}$	$V_{GE}=0V, I_C=0.2mA$	600	-	-	V
Collector-emitter saturation voltage	$V_{CE(sat)}$	$V_{GE} = 15V, I_C=4A$ $T_j=25^\circ\text{C}$ $T_j=175^\circ\text{C}$	- -	1.5 1.9	2.05 -	
Diode forward voltage	V_F	$V_{GE}=0V, I_F=4A$ $T_j=25^\circ\text{C}$ $T_j=175^\circ\text{C}$	- -	1.65 1.6	2.05 -	μA
Gate-emitter threshold voltage	$V_{GE(th)}$	$I_C = 60\mu A, V_{CE} = V_{GE}$	4.1	4.9	5.7	
Zero gate voltage collector current	I_{CES}	$V_{CE}=600V,$ $V_{GE}=0V$ $T_j=25^\circ\text{C}$ $T_j=175^\circ\text{C}$	- -	- -	40 1000	
Gate-emitter leakage current	I_{GES}	$V_{CE}=0V, V_{GE}=20V$	-	-	100	nA
Transconductance	g_{fs}	$V_{CE}=20V, I_C=4A$	-	2.2	-	S
Integrated gate resistor	R_{Gint}			-		Ω

Dynamic Characteristic

Input capacitance	C_{iss}	$V_{CE}=25V,$	-	252	-	pF
Output capacitance	C_{oss}	$V_{GE}=0V,$	-	20	-	
Reverse transfer capacitance	C_{riss}	$f=1MHz$	-	7.5	-	
Gate charge	Q_{Gate}	$V_{CC}=480V, I_C=4A$ $V_{GE}=15V$	-	27	-	nC
Internal emitter inductance measured 5mm (0.197 in.) from case	L_E		-	7	-	nH
Short circuit collector current ¹⁾	$I_{C(SC)}$	$V_{GE}=15V, t_{SC}\leq 5\mu s$ $V_{CC}=400V,$ $T_j\leq 150^\circ\text{C}$	-	36	-	A

¹⁾ Allowed number of short circuits: <1000; time between short circuits: >1s.

Switching Characteristic, Inductive Load, at $T_j=25^\circ\text{C}$

Parameter	Symbol	Conditions	Value			Unit
			min.	Typ.	max.	
IGBT Characteristic						
Turn-on delay time	$t_{d(on)}$	$T_j=25^\circ\text{C}$, $V_{CC}=400\text{V}$, $I_C=4\text{A}$, $V_{GE}=0/15\text{V}$, $R_G=47\ \Omega$, $L_{\sigma}^{1)}$ = 150nH, $C_{\sigma}^{1)}$ = 47pF Energy losses include "tail" and diode reverse recovery.	-	14	-	ns
Rise time	t_r		-	7	-	
Turn-off delay time	$t_{d(off)}$		-	164	-	
Fall time	t_f		-	43	-	
Turn-on energy	E_{on}		-	61	-	μJ
Turn-off energy	E_{off}		-	84	-	
Total switching energy	E_{ts}		-	145	-	
Anti-Parallel Diode Characteristic						
Diode reverse recovery time	t_{rr}	$T_j=25^\circ\text{C}$, $V_R=400\text{V}$, $I_F=4\text{A}$, $di_F/dt=610\text{A}/\mu\text{s}$	-	28	-	ns
Diode reverse recovery charge	Q_{rr}		-	79	-	nC
Diode peak reverse recovery current	I_{rrm}		-	5.3	-	A
Diode peak rate of fall of reverse recovery current during t_b	di_{rr}/dt		-	346	-	A/μs

Switching Characteristic, Inductive Load, at $T_j=175^\circ\text{C}$

Parameter	Symbol	Conditions	Value			Unit
			min.	Typ.	max.	
IGBT Characteristic						
Turn-on delay time	$t_{d(on)}$	$T_j=175^\circ\text{C}$, $V_{CC}=400\text{V}$, $I_C=4\text{A}$, $V_{GE}=0/15\text{V}$, $R_G=47\ \Omega$, $L_{\sigma}^{1)}$ = 150nH, $C_{\sigma}^{1)}$ = 47pF Energy losses include "tail" and diode reverse recovery.	-	14	-	ns
Rise time	t_r		-	10	-	
Turn-off delay time	$t_{d(off)}$		-	185	-	
Fall time	t_f		-	83	-	
Turn-on energy	E_{on}		-	99	-	μJ
Turn-off energy	E_{off}		-	97	-	
Total switching energy	E_{ts}		-	196	-	
Anti-Parallel Diode Characteristic						
Diode reverse recovery time	t_{rr}	$T_j=175^\circ\text{C}$, $V_R=400\text{V}$, $I_F=4\text{A}$, $di_F/dt=610\text{A}/\mu\text{s}$	-	95	-	ns
Diode reverse recovery charge	Q_{rr}		-	291	-	nC
Diode peak reverse recovery current	I_{rrm}		-	6.6	-	A
Diode peak rate of fall of reverse recovery current during t_b	di_{rr}/dt		-	253	-	A/μs

¹⁾ Leakage inductance L_{σ} and Stray capacity C_{σ} due to dynamic test circuit in Figure E.

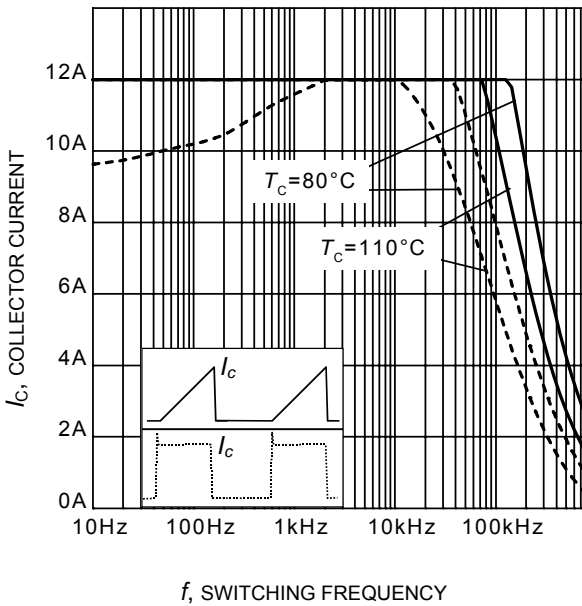

Figure 1. Collector current as a function of switching frequency
($T_j \leq 175^\circ\text{C}$, $D = 0.5$, $V_{CE} = 400\text{V}$, $V_{GE} = 0/+15\text{V}$, $R_G = 47\Omega$)

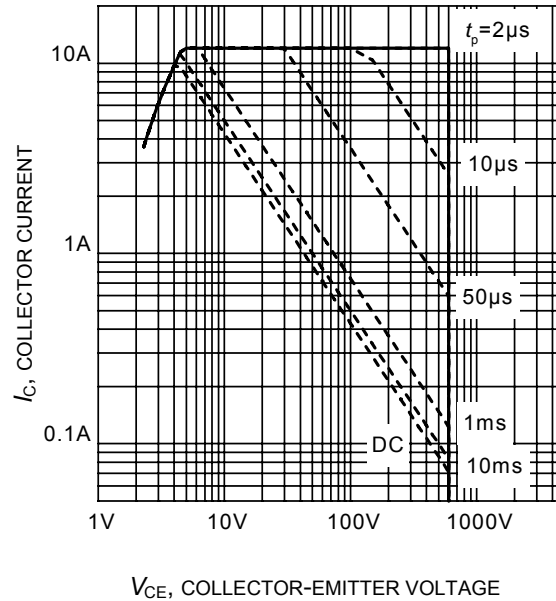

Figure 2. Safe operating area
($D = 0$, $T_C = 25^\circ\text{C}$, $T_j \leq 175^\circ\text{C}$; $V_{GE} = 15\text{V}$)

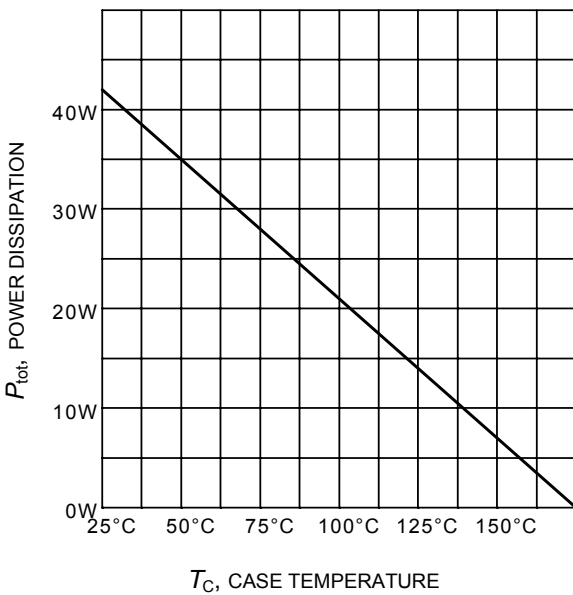

Figure 3. Power dissipation as a function of case temperature
($T_j \leq 175^\circ\text{C}$)

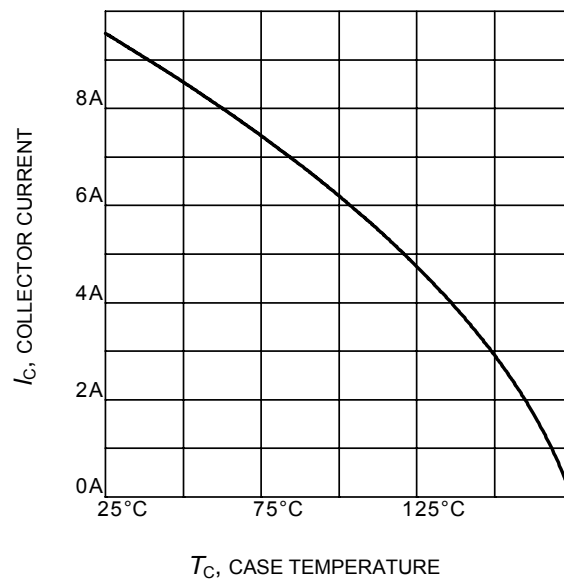

Figure 4. Collector current as a function of case temperature
($V_{GE} \geq 15\text{V}$, $T_j \leq 175^\circ\text{C}$)

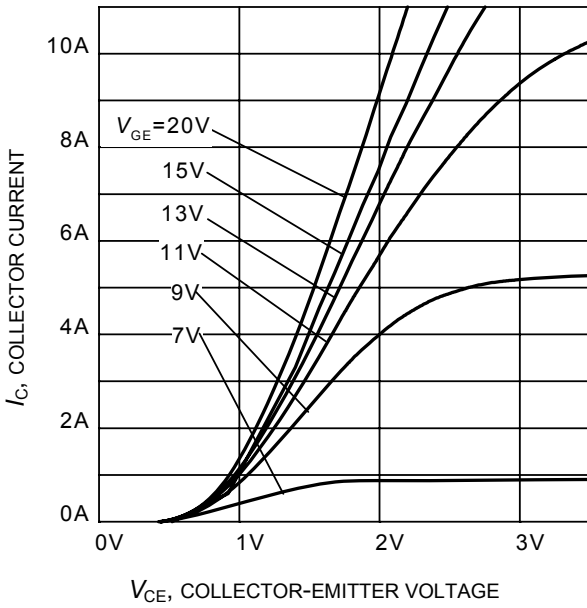

Figure 5. Typical output characteristic
($T_J = 25^\circ\text{C}$)

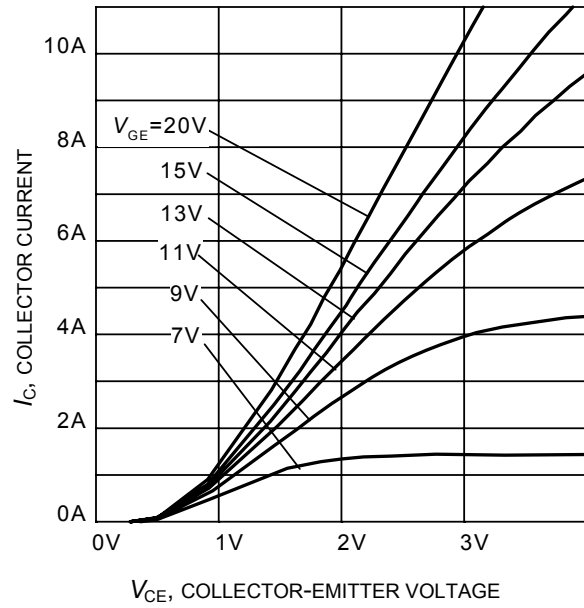

Figure 6. Typical output characteristic
($T_J = 175^\circ\text{C}$)

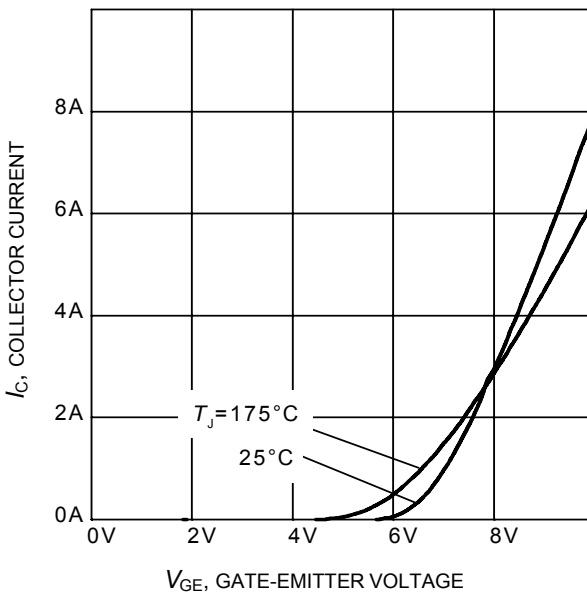

Figure 7. Typical transfer characteristic
($V_{CE} = 20\text{V}$)

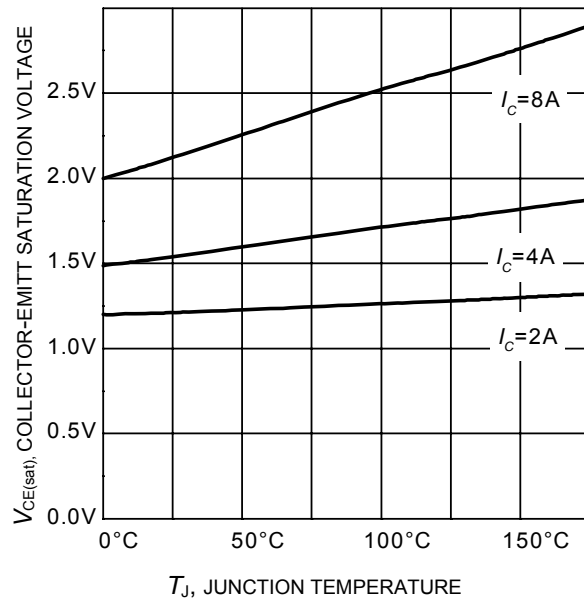
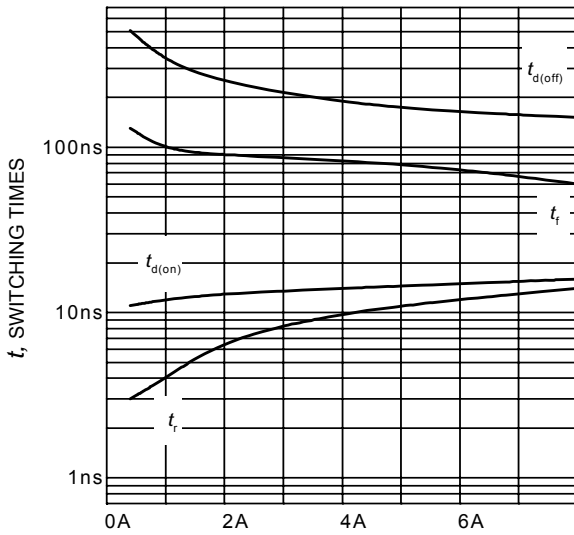
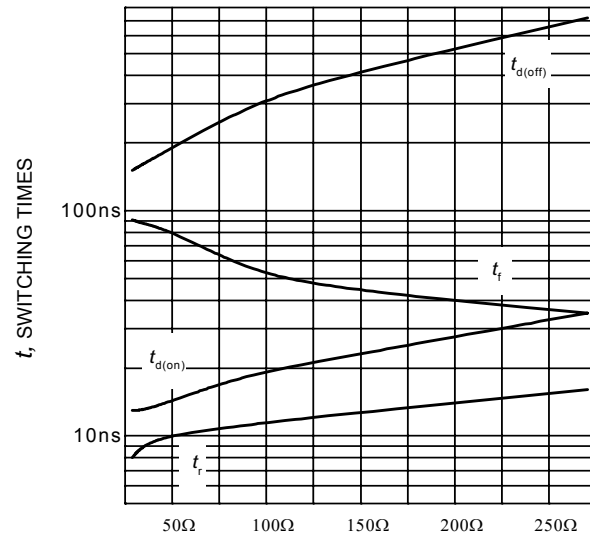

Figure 8. Typical collector-emitter saturation voltage as a function of junction temperature
($V_{GE} = 15\text{V}$)



I_C , COLLECTOR CURRENT

Figure 9. Typical switching times as a function of collector current
(inductive load, $T_J=175^\circ\text{C}$,
 $V_{CE} = 400\text{V}$, $V_{GE} = 0/15\text{V}$, $R_G = 47\Omega$,
Dynamic test circuit in Figure E)



R_G , GATE RESISTOR

Figure 10. Typical switching times as a function of gate resistor
(inductive load, $T_J = 175^\circ\text{C}$,
 $V_{CE} = 400\text{V}$, $V_{GE} = 0/15\text{V}$, $I_C = 4\text{A}$,
Dynamic test circuit in Figure E)

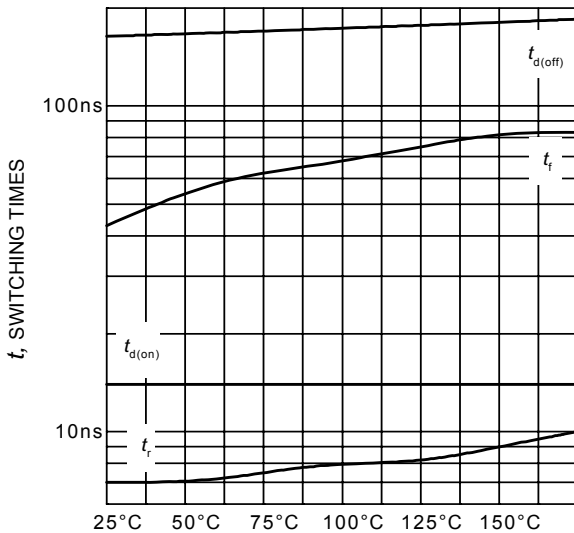

T_J , JUNCTION TEMPERATURE

Figure 11. Typical switching times as a function of junction temperature
(inductive load, $V_{CE} = 400\text{V}$,
 $V_{GE} = 0/15\text{V}$, $I_C = 4\text{A}$, $R_G=47\Omega$,
Dynamic test circuit in Figure E)

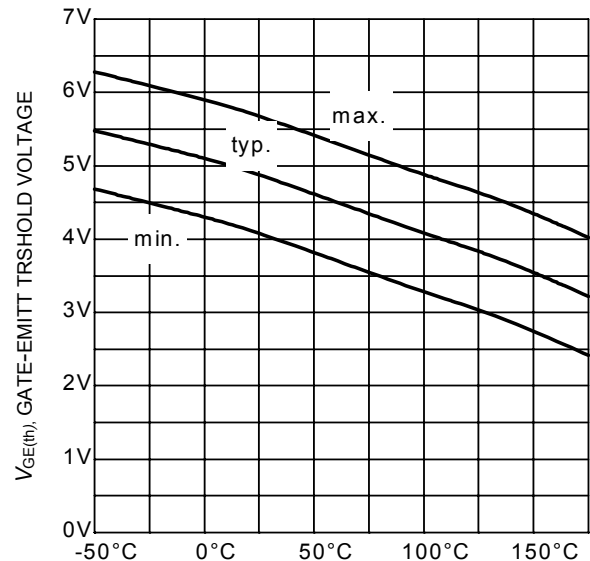

T_J , JUNCTION TEMPERATURE

Figure 12. Gate-emitter threshold voltage as a function of junction temperature
($I_C = 60 \mu\text{A}$)

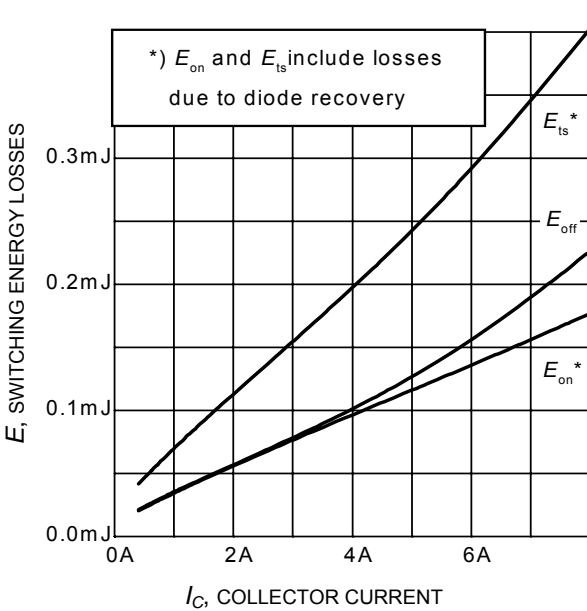

Figure 13. Typical switching energy losses as a function of collector current
(inductive load, $T_J = 175^\circ\text{C}$, $V_{CE} = 400\text{V}$, $V_{GE} = 0/15\text{V}$, $R_G = 47\Omega$, Dynamic test circuit in Figure E)

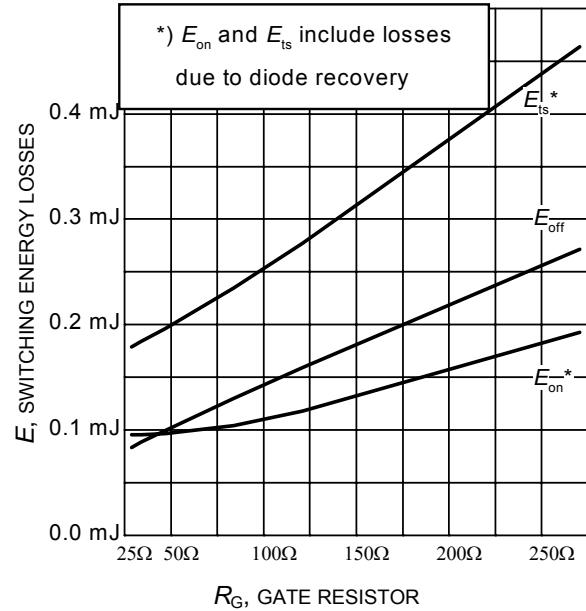

Figure 14. Typical switching energy losses as a function of gate resistor
(inductive load, $T_J = 175^\circ\text{C}$, $V_{CE} = 400\text{V}$, $V_{GE} = 0/15\text{V}$, $I_C = 4\text{A}$, Dynamic test circuit in Figure E)

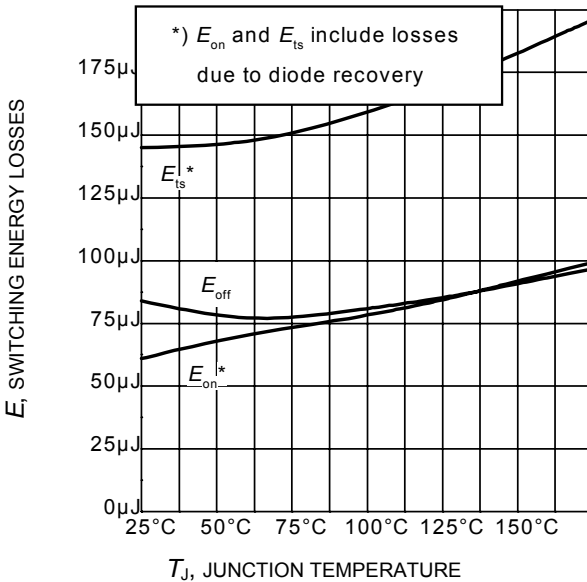

Figure 15. Typical switching energy losses as a function of junction temperature
(inductive load, $V_{CE} = 400\text{V}$, $V_{GE} = 0/15\text{V}$, $I_C = 4\text{A}$, $R_G = 47\Omega$, Dynamic test circuit in Figure E)

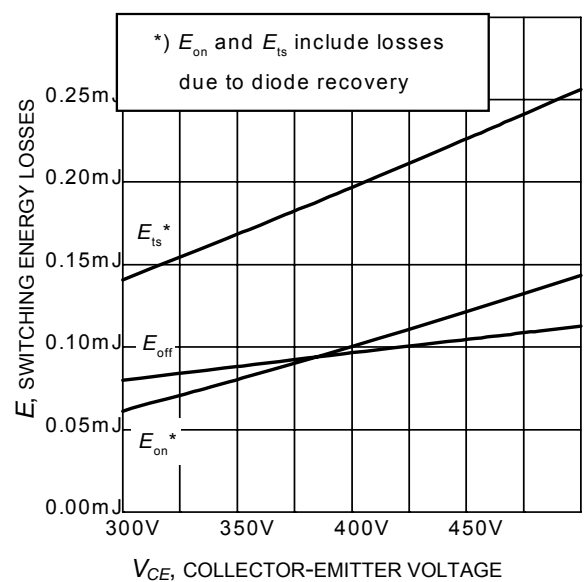

Figure 16. Typical switching energy losses as a function of collector emitter voltage
(inductive load, $T_J = 175^\circ\text{C}$, $V_{GE} = 0/15\text{V}$, $I_C = 4\text{A}$, $R_G = 47\Omega$, Dynamic test circuit in Figure E)

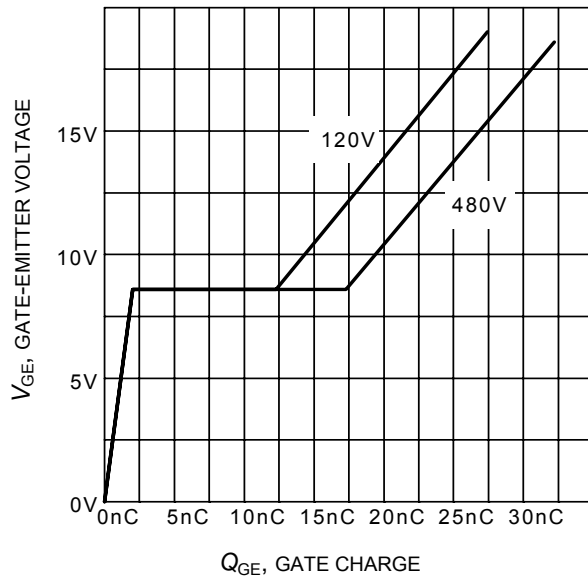

Figure 17. Typical gate charge
($I_C=4\text{ A}$)

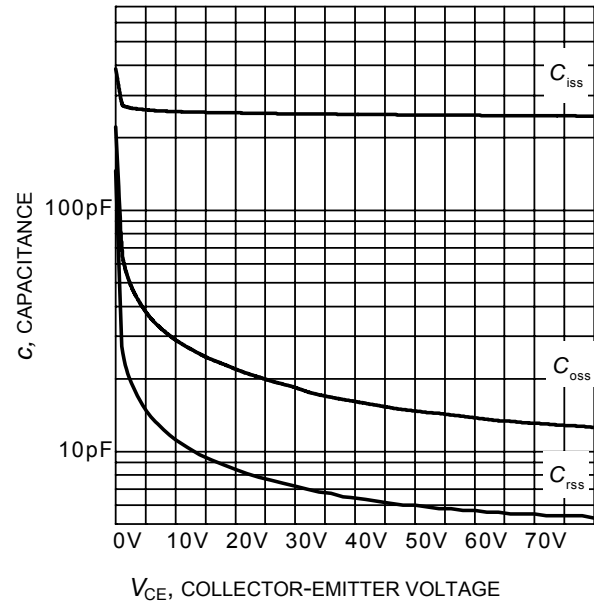

Figure 18. Typical capacitance as a function of collector-emitter voltage
($V_{GE}=0\text{V}$, $f=1\text{ MHz}$)

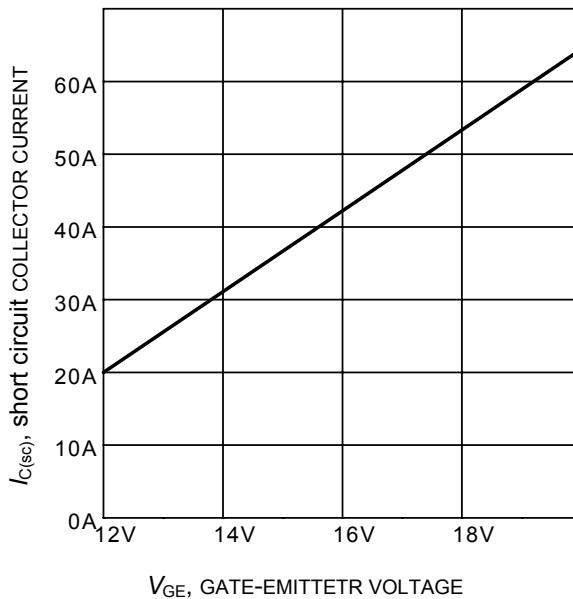

Figure 19. Typical short circuit collector current as a function of gate-emitter voltage
($V_{CE} \leq 400\text{V}$, $T_j \leq 150^\circ\text{C}$)

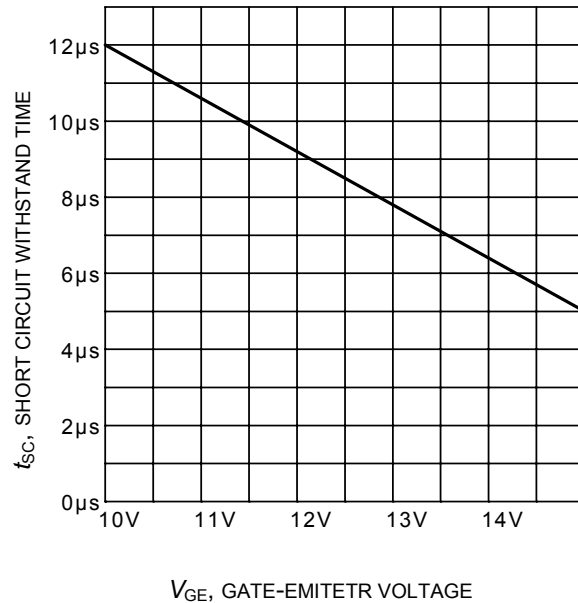

Figure 20. Short circuit withstand time as a function of gate-emitter voltage
($V_{CE}=600\text{V}$, start at $T_j=25^\circ\text{C}$, $T_{jmax}<150^\circ\text{C}$)

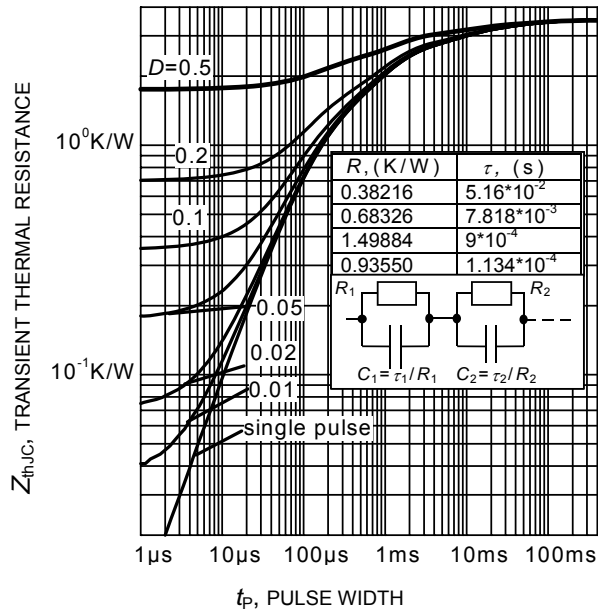

Figure 21. IGBT transient thermal resistance
($D = t_p / T$)

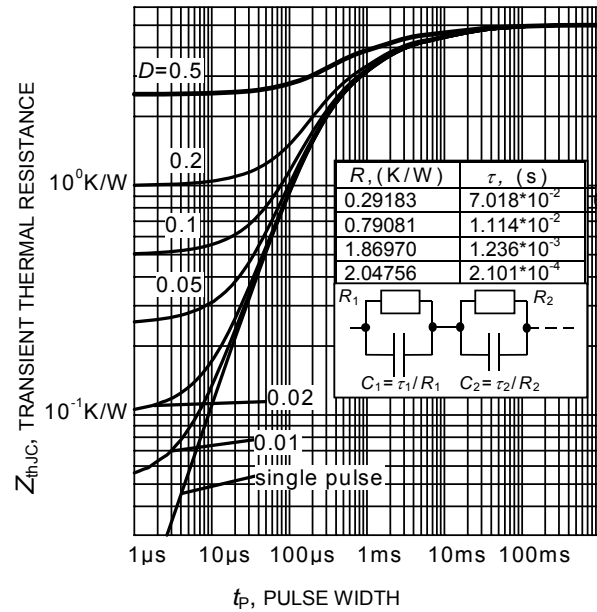

Figure 22. Diode transient thermal impedance as a function of pulse width
($D = t_p / T$)

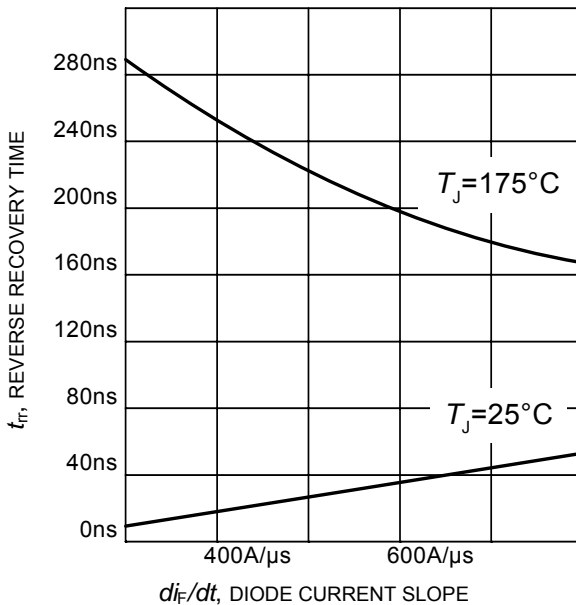

Figure 23. Typical reverse recovery time as a function of diode current slope
($V_R = 400V$, $I_F = 4A$,
Dynamic test circuit in Figure E)

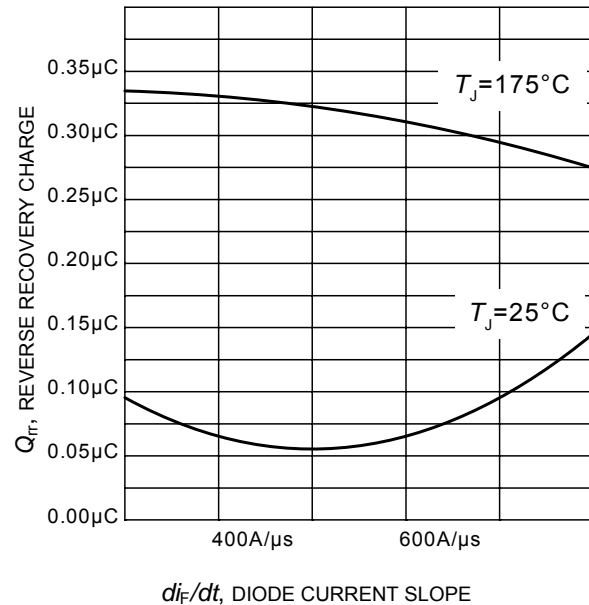
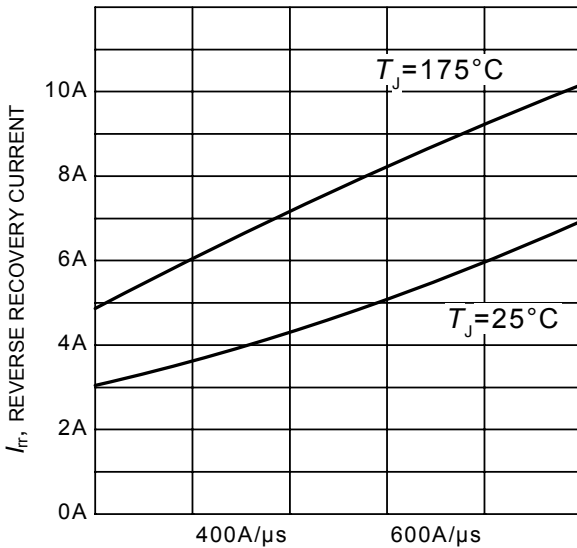
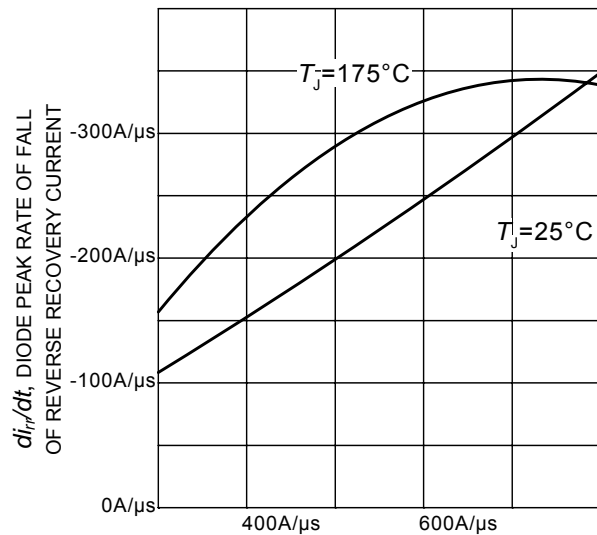

Figure 24. Typical reverse recovery charge as a function of diode current slope
($V_R = 400V$, $I_F = 4A$,
Dynamic test circuit in Figure E)



di_F/dt , DIODE CURRENT SLOPE
Figure 25. Typical reverse recovery current as a function of diode current slope
($V_R = 400V$, $I_F = 4A$,
Dynamic test circuit in Figure E)



di_I/dt , DIODE CURRENT SLOPE
Figure 26. Typical diode peak rate of fall of reverse recovery current as a function of diode current slope
($V_R = 400V$, $I_F = 4A$,
Dynamic test circuit in Figure E)

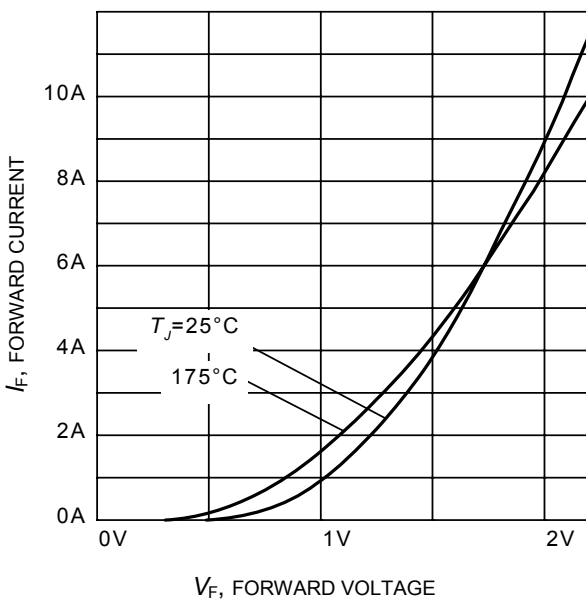

V_F , FORWARD VOLTAGE
Figure 27. Typical diode forward current as a function of forward voltage

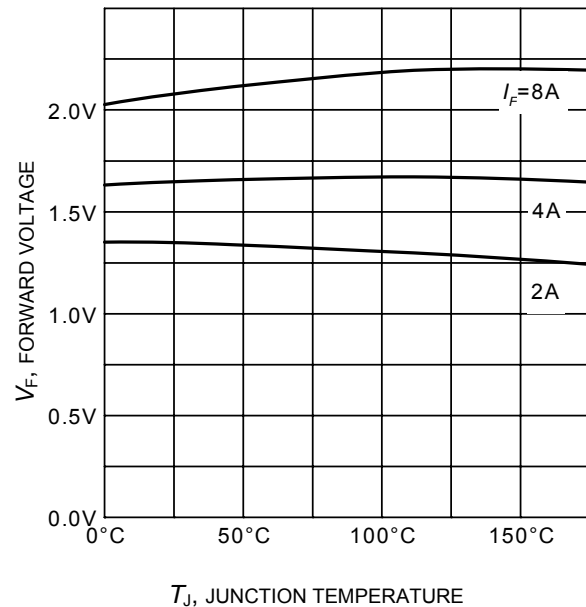

T_J , JUNCTION TEMPERATURE
Figure 28. Typical diode forward voltage as a function of junction temperature

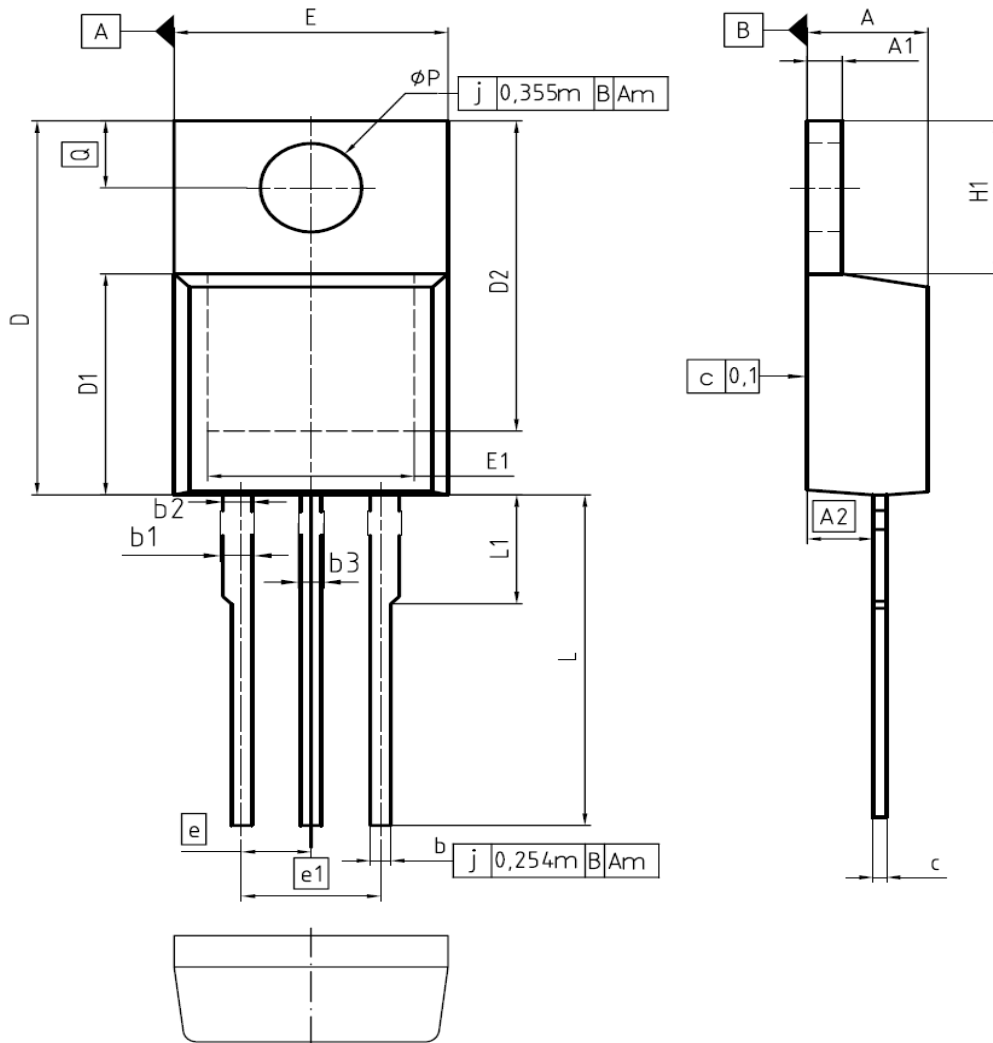

DIM	MILLIMETERS		INCHES	
	MIN	MAX	MIN	MAX
A	4.30	4.57	0.169	0.180
A1	1.17	1.40	0.046	0.055
A2	2.15	2.72	0.085	0.107
b	0.65	0.86	0.026	0.034
b1	0.95	1.40	0.037	0.055
b2	0.95	1.15	0.037	0.045
b3	0.65	1.15	0.026	0.045
c	0.33	0.60	0.013	0.024
D	14.81	15.95	0.583	0.628
D1	8.51	9.45	0.335	0.372
D2	12.19	13.10	0.480	0.516
E	9.70	10.36	0.382	0.408
E1	6.50	8.60	0.256	0.339
e	2.54		0.100	
e1	5.08		0.200	
N	3		3	
H1	5.90	6.90	0.232	0.272
L	13.00	14.00	0.512	0.551
L1	-	4.80	-	0.189
øP	3.60	3.89	0.142	0.153
Q	2.60	3.00	0.102	0.118

DOCUMENT NO.
Z8B00003318

SCALE

EUROPEAN PROJECTION

ISSUE DATE
23-08-2007

REVISION
05

T0262-3-1 / T0262-3-21

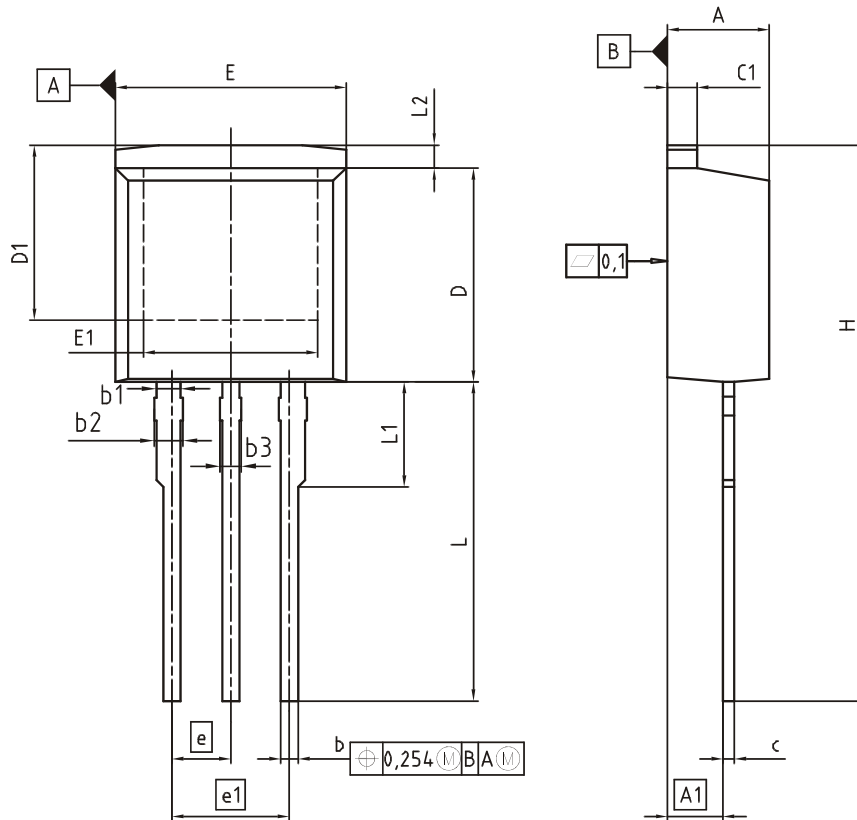

DIM	MILLIMETERS		INCHES	
	MIN	MAX	MIN	MAX
A	4.300	4.572	0.169	0.180
A1	2.150	2.718	0.085	0.107
b	0.650	0.864	0.026	0.034
b1	0.950	1.093	0.037	0.043
b2	0.950	1.400	0.037	0.055
b3	0.650	1.118	0.026	0.044
c	0.330	0.600	0.013	0.024
c1	1.170	1.400	0.046	0.055
D	8.509	9.450	0.335	0.372
D1	6.900	-	0.272	-
E	9.700	10.363	0.382	0.408
E1	6.500	8.600	0.256	0.339
e	2,540		0,100	
e1	5,080		0,200	
N	3		3	
L	13.000	14.000	0.512	0.551
L1	-	4.800	-	0.189
L2	-	1.727	-	0.068

REFERENCE
Z8B00003325

SCALE

EUROPEAN PROJECTION

ISSUE DATE
05-05-2006

REVISION
03

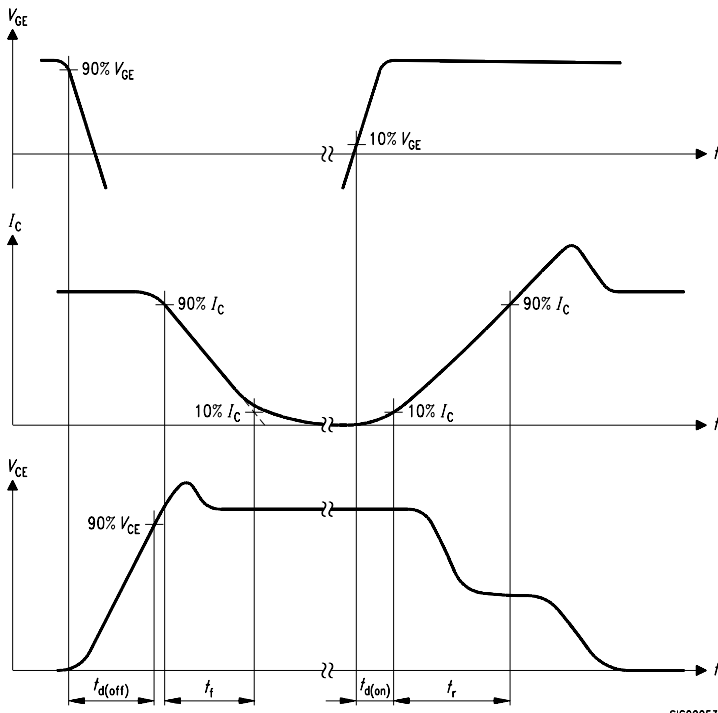

Figure A. Definition of switching times

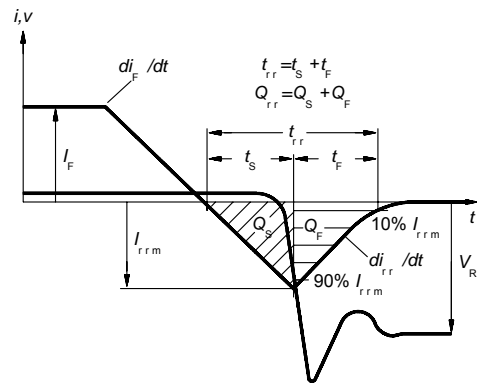

Figure C. Definition of diodes switching characteristics

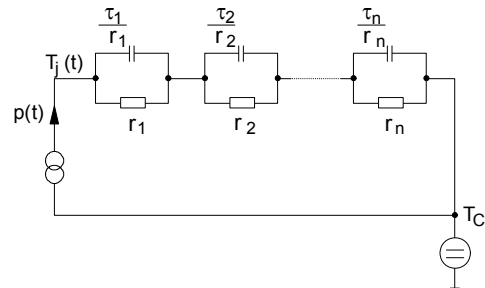

Figure D. Thermal equivalent circuit

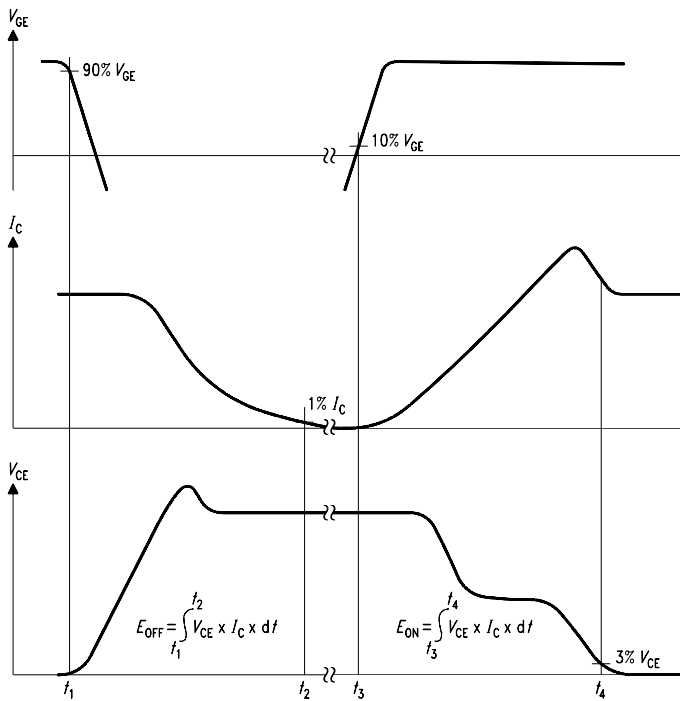

Figure B. Definition of switching losses

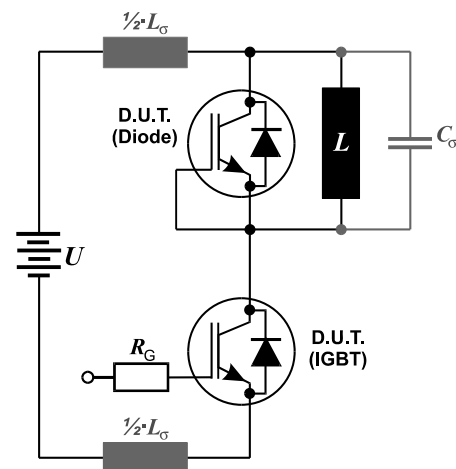

Figure E. Dynamic test circuit
Leakage inductance $L_\sigma = 60\text{nH}$
and Stray capacity $C_\sigma = 40\text{pF}$.

Edition 2006-01

**Published by
Infineon Technologies AG
81726 München, Germany**

**© Infineon Technologies AG 2/16/09.
All Rights Reserved.**

Attention please!

The information given in this data sheet shall in no event be regarded as a guarantee of conditions or characteristics ("Beschaffheitsgarantie"). With respect to any examples or hints given herein, any typical values stated herein and/or any information regarding the application of the device, Infineon Technologies hereby disclaims any and all warranties and liabilities of any kind, including without limitation warranties of non-infringement of intellectual property rights of any third party.

Information

For further information on technology, delivery terms and conditions and prices please contact your nearest Infineon Technologies Office (www.infineon.com).

Warnings

Due to technical requirements components may contain dangerous substances. For information on the types in question please contact your nearest Infineon Technologies Office.

Infineon Technologies Components may only be used in life-support devices or systems with the express written approval of Infineon Technologies, if a failure of such components can reasonably be expected to cause the failure of that life-support device or system, or to affect the safety or effectiveness of that device or system. Life support devices or systems are intended to be implanted in the human body, or to support and/or maintain and sustain and/or protect human life. If they fail, it is reasonable to assume that the health of the user or other persons may be endangered.



Стандарт Электрон Связь

Мы молодая и активно развивающаяся компания в области поставок электронных компонентов. Мы поставляем электронные компоненты отечественного и импортного производства напрямую от производителей и с крупнейших складов мира.

Благодаря сотрудничеству с мировыми поставщиками мы осуществляем комплексные и плановые поставки широчайшего спектра электронных компонентов.

Собственная эффективная логистика и склад в обеспечивает надежную поставку продукции в точно указанные сроки по всей России.

Мы осуществляем техническую поддержку нашим клиентам и предпродажную проверку качества продукции. На все поставляемые продукты мы предоставляем гарантию .

Осуществляем поставки продукции под контролем ВП МО РФ на предприятия военно-промышленного комплекса России , а также работаем в рамках 275 ФЗ с открытием отдельных счетов в уполномоченном банке. Система менеджмента качества компании соответствует требованиям ГОСТ ISO 9001.

Минимальные сроки поставки, гибкие цены, неограниченный ассортимент и индивидуальный подход к клиентам являются основой для выстраивания долгосрочного и эффективного сотрудничества с предприятиями радиоэлектронной промышленности, предприятиями ВПК и научно-исследовательскими институтами России.

С нами вы становитесь еще успешнее!

Наши контакты:

Телефон: +7 812 627 14 35

Электронная почта: sales@st-electron.ru

Адрес: 198099, Санкт-Петербург,
Промышленная ул, дом № 19, литера Н,
помещение 100-Н Офис 331