

DATA SHEET

SMP1321 Series: Low Capacitance, Plastic Packaged PIN Diodes

Applications

- High-performance wireless switches

Features

- Capacitance: 0.18 pF typical @ 30 V
- Series resistance: 1.05 Ω typical @ 10 mA
- Packages rated MSL1, 260 °C per JEDEC J-STD-020



Skyworks Green™ products are compliant with all applicable legislation and are halogen-free. For additional information, refer to *Skyworks Definition of Green™*, document number SQ04-0074.









Description

The SMP1321 series of plastic packaged, surface mountable PIN diodes is designed for use in high volume switch applications from 10 MHz to more than 10 GHz. The low capacitance of these diodes (0.25 pF maximum at 30 V), combined with a low resistance (2.0 Ω maximum at 10 mA), makes the SMP1321 series particularly suited for high isolation, series-connected PIN diode switches in battery operated circuits.

The SMP1321 series is available in a selection of plastic packages and a variety of configurations that include a small footprint SC-79, a low inductance SOT-23, a miniature SOD-882, and an SOD-323.

Table 1 describes the various packages and marking of the SMP1321 series.

Table 1. SMP1321 Series Packaging and Marking

					
Common Anode	Series Pair	Low Inductance	Single	Single	Single
SOT-23	SOT-23	SOT-23	SC-79 Green™	SOD-882 Green™	SOD-323 Green™
SMP1321-003LF Green™ Marking: RM9	◆ SMP1321-005LF Green™ Marking: RM2	SMP1321-007LF Green™ Marking: RMB	SMP1321-079LF Marking: Cathode and C6	SMP1321-040LF Marking: C	SMP1321-011LF Marking: RM
$L_s = 1.5 \text{ nH}$	$L_s = 1.5 \text{ nH}$	$L_s = 0.4 \text{ nH}$	$L_s = 0.7 \text{ nH}$	$L_s = 0.45 \text{ nH}$	$L_s = 1.5 \text{ nH}$

 The Pb-free symbol or "LF" in the part number denotes a lead-free, RoHS-compliant package unless otherwise noted as Green™. Tin/lead (Sn/Pb) packaging is not recommended for new designs.

SMP1321-007

For the -007 configuration of the SOT-23 package, the package inductance is effectively reduced to 0.4 nH compared to the 1.5 nH value of the standard configuration. This lower inductance is particularly beneficial when the diodes are used as shunt connected switches at frequencies higher than 500 MHz in which inductance is the primary limitation on maximum switch isolation.

To achieve the effective 0.4 nH, the SOT-23 package must be inserted in the microstrip circuit board with a gap in the trace, as shown in Figure 1. Because of the polarity of the diode junction, this low inductance feature is realizable only with the cathode connected to ground.

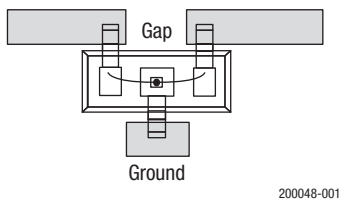

Figure 1. SOT-23 Package Trace Gap

Electrical and Mechanical Specifications

The part number and configuration for the SMP1321 series are provided in Table 1. The absolute maximum ratings of the SMP1321 series are provided in Table 2. Electrical specifications are provided in Table 3. Resistance versus temperature measurements are provided in Table 4.

Typical performance characteristics of the SMP1321 series are illustrated in Figures 2 to 5.

Package Dimensions

Package dimensions are shown in Figures 6 to 12 (even numbers), and tape and reel dimensions are provided in Figures 7 to 13 (odd numbers).

Package and Handling Information

Instructions on the shipping container label regarding exposure to moisture after the container seal is broken must be followed. Otherwise, problems related to moisture absorption may occur when the part is subjected to high temperature during solder assembly.

The SMP1321 series is rated to Moisture Sensitivity Level 1 (MSL1) at 260 °C. It can be used for lead or lead-free soldering. For additional information, refer to the Skyworks Application Note, *Solder Reflow Information*, document number 200164.

Care must be taken when attaching this product, whether it is done manually or in a production solder reflow environment. Production quantities of this product are shipped in a standard tape and reel format.

Table 2. SMP1321 Series Absolute Maximum Ratings (Per Junction)¹

Parameter	Symbol	Minimum	Maximum	Units
Reverse voltage	V_R		100	V
Power dissipation @ 25 °C lead temperature	P_D		400	mW
Storage temperature	T_{STG}	-65	+150	°C
Operating temperature	T_A	-65	+150	°C
Electrostatic discharge: Human Body Model (HBM), Class 1A	ESD		500	V

¹ Exposure to maximum rating conditions for extended periods may reduce device reliability. There is no damage to device with only one parameter set at the limit and all other parameters set at or below their nominal value. Exceeding any of the limits listed here may result in permanent damage to the device.

ESD HANDLING: Although this device is designed to be as robust as possible, electrostatic discharge (ESD) can damage this device. This device must be protected at all times from ESD when handling or transporting. Static charges may easily produce potentials of several kilovolts on the human body or equipment, which can discharge without detection. Industry-standard ESD handling precautions should be used at all times.

Table 3. SMP1321 Series Electrical Specifications (Per Junction)¹
($T_A = +25\text{ °C}$, Unless Otherwise Noted)

Parameter	Symbol	Test Condition	Min	Typical	Max	Units
Reverse current	I_R	$V_R = 100\text{ V}$			10	μA
Capacitance ²	C_T	$F = 1\text{ MHz}, V = 30\text{ V}$		0.18	0.25	pF
Resistance	R_S	$F = 100\text{ MHz}$ $I = 1\text{ mA}$ $I = 10\text{ mA}$		3.00 1.05	2.00	Ω Ω
Forward voltage	V_F	$I_F = 10\text{ mA}$		0.85		V
Carrier lifetime	τ_I	$I_F = 10\text{ mA}$		0.4		μs
I region width				12		μm

¹ Performance is guaranteed only under the conditions listed in this table.

² C_T is 0.4 pF maximum for the SMP1321-007.

Table 4. Resistance vs Temperature @ 500 MHz (Per Junction)

I_F (mA)	$R_S @ -55\text{ °C}$ (Ω)	$R_S @ -15\text{ °C}$ (Ω)	$R_S @ +25\text{ °C}$ (Ω)	$R_S @ +65\text{ °C}$ (Ω)	$R_S @ +100\text{ °C}$ (Ω)
0.02	47.4	50.0	56.3	61.5	65.1
0.10	12.0	12.6	13.9	15.4	16.4
0.3	5.2	5.4	5.8	6.4	6.9
0.5	3.6	3.8	4.1	4.5	4.8
1.0	2.4	2.5	2.6	2.8	3.1
10	1.03	1.04	1.04	1.07	1.15
20	0.871	0.888	0.873	0.889	0.956
100	0.669	0.659	0.642	0.645	0.695

Typical Performance Characteristics (Per Junction)

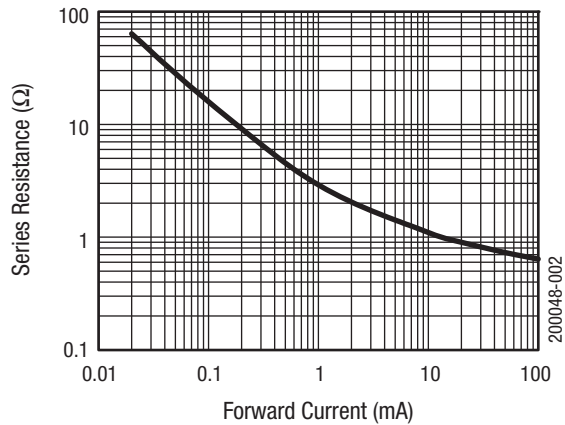

Figure 2. Series Resistance vs Current @ 100 MHz

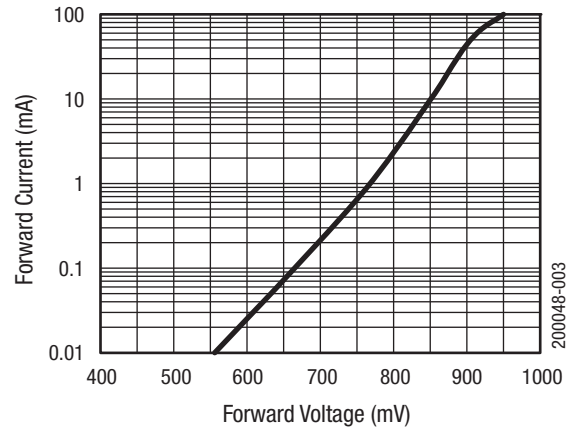

Figure 3. Forward Current vs Voltage

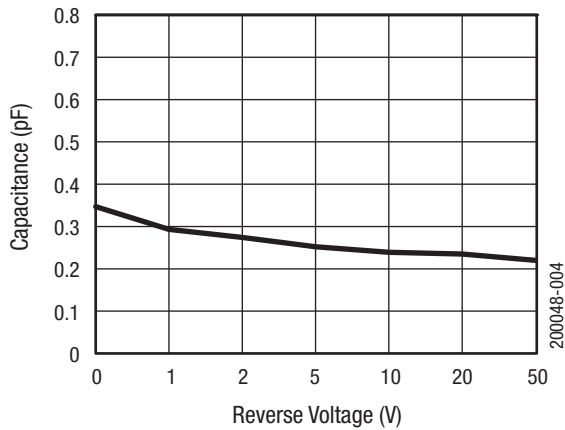

Figure 4. Capacitance vs Reverse Voltage (1 MHz to 1 GHz)

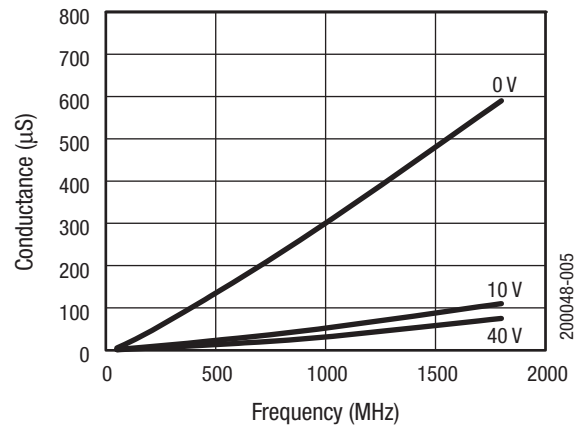
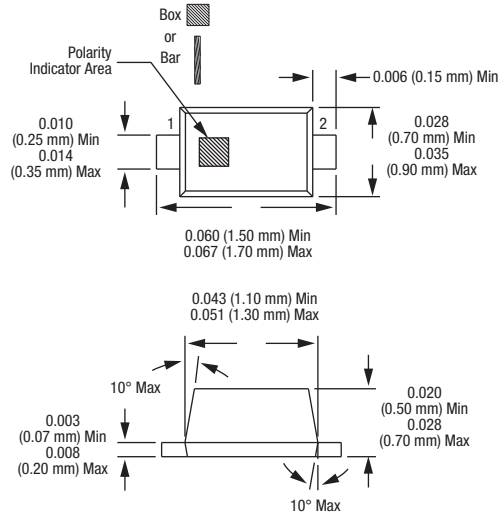
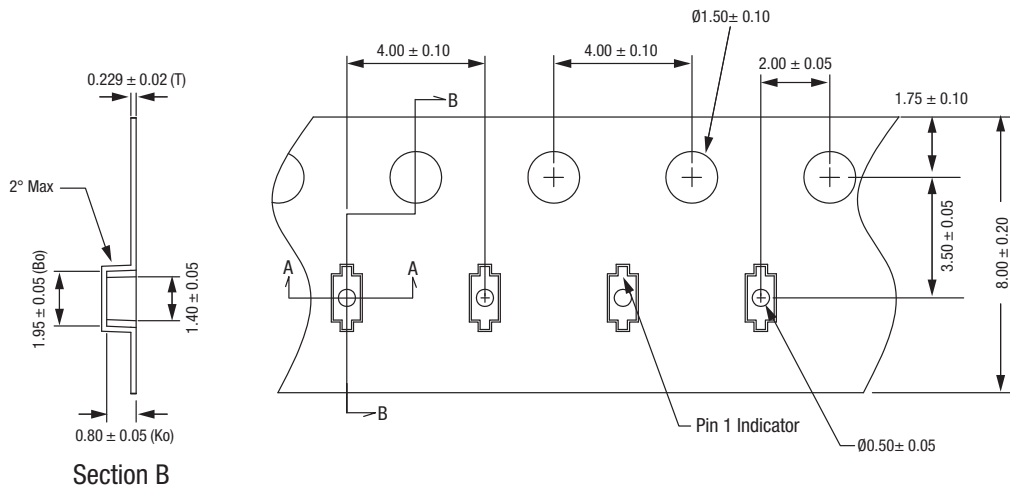

Figure 5. Conductance vs Frequency and Reverse Voltage



Dimensions are in inches (millimeters shown in parentheses) 200048-006

Figure 6. SC-79 Package Dimension Drawing



Notes:

1. Carrier tape: black conductive polycarbonate or polystyrene.
2. Cover tape material: transparent conductive PSA.
3. Cover tape size: 5.4 mm width.
4. ESD-surface resistivity is $\leq 1 \times 10^8$ Ohms/square per EIA, JEDEC TNR Specification.
5. All measurements are in millimeters.

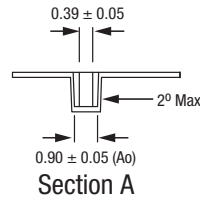

200048-007

Figure 7. SC-79 Tape and Reel Dimensions

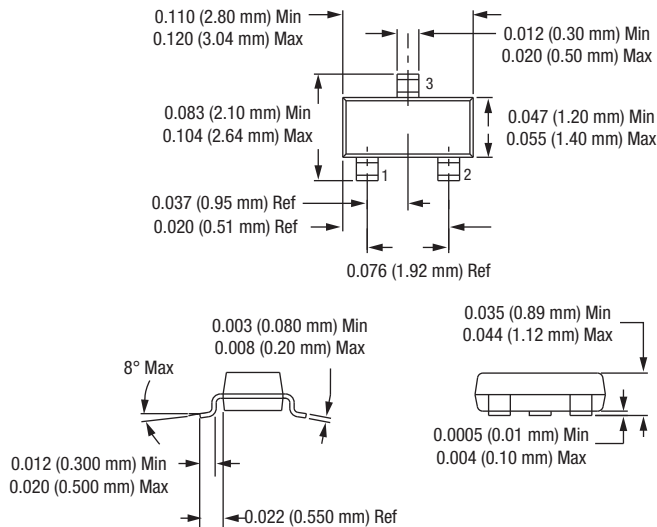

Dimensions are in inches (millimeters shown in parentheses) 200048-008

Figure 8. SOT-23 Package Dimension Drawing

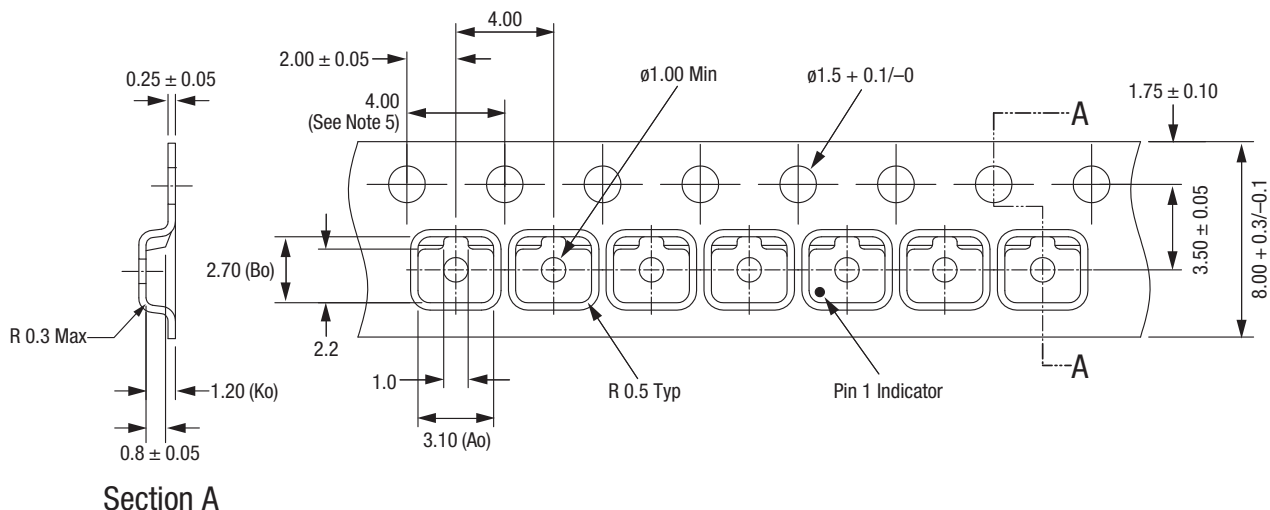

Section A

Notes:

1. Carrier tape: black conductive polycarbonate.
2. Cover tape material: transparent conductive PSA.
3. Cover tape size: 5.40 mm width.
4. Tolerance ±0.10 mm.
5. Ten sprocket hole pitch cumulative tolerance: ±0.2 mm.
6. All measurements are in millimeters.
7. Alternative carrier tape dimensions are:
 $A_o = 3.3$
 $B_o = 2.9$
 $K_o = 1.22$

200048-009

Figure 9. SOT-23 Tape and Reel Dimensions

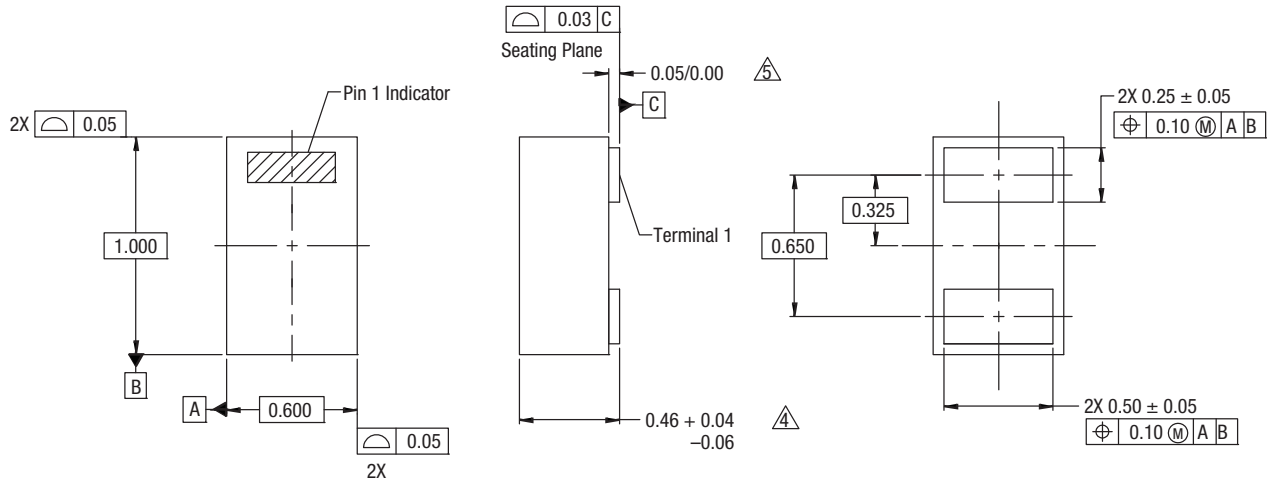

Notes:

1. All measurements are in millimeters.
2. Dimensions and tolerances according to ASME Y14.5M-1994.
3. These packages are used principally for discrete devices.
4. This dimension includes stand-off height and package body thickness, but does not include attached features, e.g., external heatsink or chip capacitors. An integral heatslug is not considered an attached feature.
5. This dimension is primarily terminal plating, but does not include small metal protrusion.

200048-010

Figure 10. SOD-882 Package Dimension Drawing

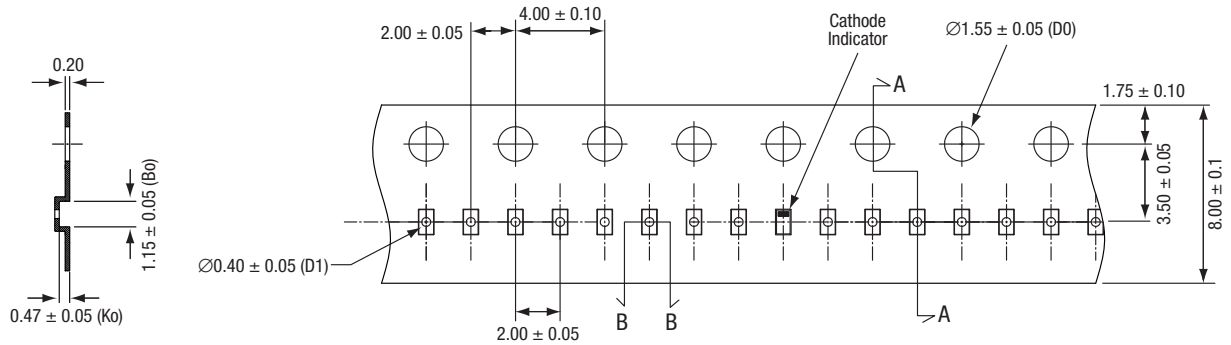

Section A

Notes:

1. Carrier tape: black conductive polycarbonate.
2. Cover tape: transparent conductive material.
3. Cover tape size: 5.4 mm width.
4. ESD surface resistivity is $\geq 1 \times 10^4 \sim \leq 1 \times 10^8$ Ohms/square.
5. All dimensions are in millimeters.

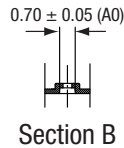

200048-011

Figure 11. SOD-882 Tape and Reel Dimensions

Copyright © 2002-2007, 2009- 2012, 2014-2017 Skyworks Solutions, Inc. All Rights Reserved.

Information in this document is provided in connection with Skyworks Solutions, Inc. ("Skyworks") products or services. These materials, including the information contained herein, are provided by Skyworks as a service to its customers and may be used for informational purposes only by the customer. Skyworks assumes no responsibility for errors or omissions in these materials or the information contained herein. Skyworks may change its documentation, products, services, specifications or product descriptions at any time, without notice. Skyworks makes no commitment to update the materials or information and shall have no responsibility whatsoever for conflicts, incompatibilities, or other difficulties arising from any future changes.

No license, whether express, implied, by estoppel or otherwise, is granted to any intellectual property rights by this document. Skyworks assumes no liability for any materials, products or information provided hereunder, including the sale, distribution, reproduction or use of Skyworks products, information or materials, except as may be provided in Skyworks Terms and Conditions of Sale.

THE MATERIALS, PRODUCTS AND INFORMATION ARE PROVIDED "AS IS" WITHOUT WARRANTY OF ANY KIND, WHETHER EXPRESS, IMPLIED, STATUTORY, OR OTHERWISE, INCLUDING FITNESS FOR A PARTICULAR PURPOSE OR USE, MERCHANTABILITY, PERFORMANCE, QUALITY OR NON-INFRINGEMENT OF ANY INTELLECTUAL PROPERTY RIGHT; ALL SUCH WARRANTIES ARE HEREBY EXPRESSLY DISCLAIMED. SKYWORKS DOES NOT WARRANT THE ACCURACY OR COMPLETENESS OF THE INFORMATION, TEXT, GRAPHICS OR OTHER ITEMS CONTAINED WITHIN THESE MATERIALS. SKYWORKS SHALL NOT BE LIABLE FOR ANY DAMAGES, INCLUDING BUT NOT LIMITED TO ANY SPECIAL, INDIRECT, INCIDENTAL, STATUTORY, OR CONSEQUENTIAL DAMAGES, INCLUDING WITHOUT LIMITATION, LOST REVENUES OR LOST PROFITS THAT MAY RESULT FROM THE USE OF THE MATERIALS OR INFORMATION, WHETHER OR NOT THE RECIPIENT OF MATERIALS HAS BEEN ADVISED OF THE POSSIBILITY OF SUCH DAMAGE.

Skyworks products are not intended for use in medical, lifesaving or life-sustaining applications, or other equipment in which the failure of the Skyworks products could lead to personal injury, death, physical or environmental damage. Skyworks customers using or selling Skyworks products for use in such applications do so at their own risk and agree to fully indemnify Skyworks for any damages resulting from such improper use or sale.

Customers are responsible for their products and applications using Skyworks products, which may deviate from published specifications as a result of design defects, errors, or operation of products outside of published parameters or design specifications. Customers should include design and operating safeguards to minimize these and other risks. Skyworks assumes no liability for applications assistance, customer product design, or damage to any equipment resulting from the use of Skyworks products outside of stated published specifications or parameters.

Skyworks and the Skyworks symbol are trademarks or registered trademarks of Skyworks Solutions, Inc., in the United States and other countries. Third-party brands and names are for identification purposes only, and are the property of their respective owners. Additional information, including relevant terms and conditions, posted at www.skyworksinc.com, are incorporated by reference.



Стандарт Электрон Связь

Мы молодая и активно развивающаяся компания в области поставок электронных компонентов. Мы поставляем электронные компоненты отечественного и импортного производства напрямую от производителей и с крупнейших складов мира.

Благодаря сотрудничеству с мировыми поставщиками мы осуществляем комплексные и плановые поставки широчайшего спектра электронных компонентов.

Собственная эффективная логистика и склад в обеспечивает надежную поставку продукции в точно указанные сроки по всей России.

Мы осуществляем техническую поддержку нашим клиентам и предпродажную проверку качества продукции. На все поставляемые продукты мы предоставляем гарантию .

Осуществляем поставки продукции под контролем ВП МО РФ на предприятия военно-промышленного комплекса России , а также работаем в рамках 275 ФЗ с открытием отдельных счетов в уполномоченном банке. Система менеджмента качества компании соответствует требованиям ГОСТ ISO 9001.

Минимальные сроки поставки, гибкие цены, неограниченный ассортимент и индивидуальный подход к клиентам являются основой для выстраивания долгосрочного и эффективного сотрудничества с предприятиями радиоэлектронной промышленности, предприятиями ВПК и научно-исследовательскими институтами России.

С нами вы становитесь еще успешнее!

Наши контакты:

Телефон: +7 812 627 14 35

Электронная почта: sales@st-electron.ru

Адрес: 198099, Санкт-Петербург,
Промышленная ул, дом № 19, литера Н,
помещение 100-Н Офис 331