

Reduce inventory levels and cost by stocking actuators and base switches separately.

Contura II, III, IV, V, X, XI, XII Base switches separately: specify V with code selections 2-8 in the ordering schemes.

Contura II, III, IV, V Actuator only: VV with code A or C for selection 9, & with selections 10-14 in the ordering schemes.

Panel Seal: VPS

Contura II, III, IV, V Actuator only: VV with code A, C, E, G or P for selection 9 & with selections 10-14 in the ordering schemes.

Contura X, XI, XII actuators with lenses separately: VV with code selections 9-14 in the ordering schemes.

Contura X & XI actuators without lenses separately:

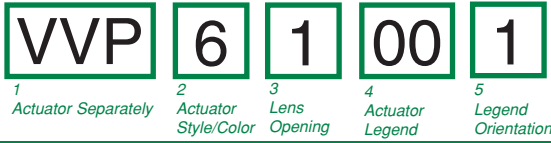

1 CONTURA X & XI ACTUATOR SEPARATELY VVP								
2 ACTUATOR STYLE & COLOR								
	Black	Gray	White	Red				
Contura X	1	2	3	4				
Contura XI	6	7	8	9				
3 LENS OPENING FOR¹								
1	One bar lens	4	Two Square lens					
2	One bar lenses	5	Square lens on top/ bar lens on bottom (Contura X only)					
3	One Square lens							
4 ACTUATOR LENS OR BODY LEGEND								
00 - No Legend this location								
11	ON	12	OFF	13	I	14	O	
	OFF		ON		O		I	
15	O	16	O	17	O	18	I	O
	F		N		N		F	
	F		F		F			
For additional legend options & codes, see page 69 of this catalog								
5 LEGEND ORIENTATION²								
0	No legend							
1	Orientation 1							
2	Orientation 2							
3	Orientation 3							
4	Orientation 4							

Contura X, XI & XII top piece of 2-piece lens separately:

VVT 1		1 TOP OF LENS SEPARATELY VVT
1	2	
Lens Separately	Color	
2 COLOR		
1	2	3
Clear	Smoke	White

Contura X, XI & XII actuator lens assembly:

actuator stem top lens

posts mount toward actuator stem bottom lens } two piece lens assembly

1 piece lens/bar lens are positioned the same as bottom lens for assembly, minus the top lens. Lenses snap in from bottom.

- NOTES**
- 1 If actuator lens opening for 2 bar or 2 square lenses, legend orientation 0, 1, or 2 must be chosen.
 - 2 Center of actuator marking not available for Contura XII.
 - 3 Legend is not available for bar style lens.
 - 4 Not recommended with neon lamps.
 - 5 Must also order top piece of 2 piece square lens separately.

Contura XII actuators without lenses separately:

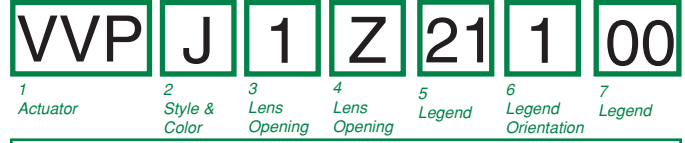

1 CONTURA XII ACTUATOR SEPARATELY VVP										
2 ACTUATOR STYLE & COLOR										
J	K	N	M							
Black	Gray	White	Red							
3,4 LENS OPENING FOR										
Z	1	2								
No lens	Bar lens	Square lens								
5, 7 LENS OR BODY LEGEND²										
00	no legend	21	OFF	22	ON	23	O	24	I	
		25	O	26	O	27	O	28	I	
			F		F		N			
For additional legend options & codes, see page 69 of this catalog.										
6 LEGEND ORIENTATION³										
0	No legend									
1	Orientation 1									
2	Orientation 2									

Contura X, XI & XII actuator lens assembly separately:

VVL 2 1 00 0								
1	2	3	4	5				
Lens Separately	Lens Style	Lens Color	Legend	Legend Orientation				
1 CONTURA X, XI & XII LENS SEPARATELY VVL								
2 LENS STYLE³								
1	2	3						
Bar lens	One Piece Square lens	Bottom of Two-Piece Square lens ⁵						
3 TRANSLUCENT LENS COLOR								
1	2	3	4	5	6			
Clear	White	Amber	Green ⁴	Red	Blue ⁴			
4 LENS OR BODY LEGEND²								
00	No legend							
21	OFF	22	ON	23	O	24	I	
	25	O	26	O	27	O	28	I
		F		N				
For additional legend options & codes, see page 69 of this catalog.								
5 LEGEND ORIENTATION³								
0	No legend							
1	Orientation 1							
2	Orientation 2							
3	Orientation 3							
4	Orientation 4							

Easily integrate Contura products into your system, with Contura Accessories

Contura Connectors

Q.C. SELECTION GUIDE					
COMPANY SERIES	PART NO		WIRE RANGE		ORIENTATION
	PLAIN BRASS	TIN PLATED BRASS	AWG	MM (REF)	
PACKARD 58 SERIES	02965580		12	3.0	B
	02965471	12010601	(2)16-14	(2)1.0-2.0	
	02965470		16-14	1.0-2.0	
	02965469	06288318	20-18	.5-.8	
PACKARD METRI-PACK 630 SERIES		12084590	12	3.0	A
		12052224	12	3.0	
		12015870	16-14	1.0-2.0	
		12020035	(2)22-18	(2).5-.8	
	12015832	12015869	20-18	.5-.8	
		12052222	20-22	.35-.5	
AMP 250 SERIES FASTIN-FASTON	60253-1	60253-2	16-12 (2) 16	1.3-3 (2) 1.3	B
	42100-1	42100-2	18-14	.8-2	
	60295-1	60295-2	22-18	.3-.9	

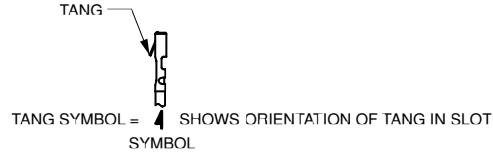

NOTE: Consult Delphi Packard and/or Amp or actual part numbers and availability.
 AMP is a registered trademark of AMP Inc. Harrisburg, PA
 Delphi Packard is a registered trademark of Delphi-Packard Electrical Systems Warren, Ohio

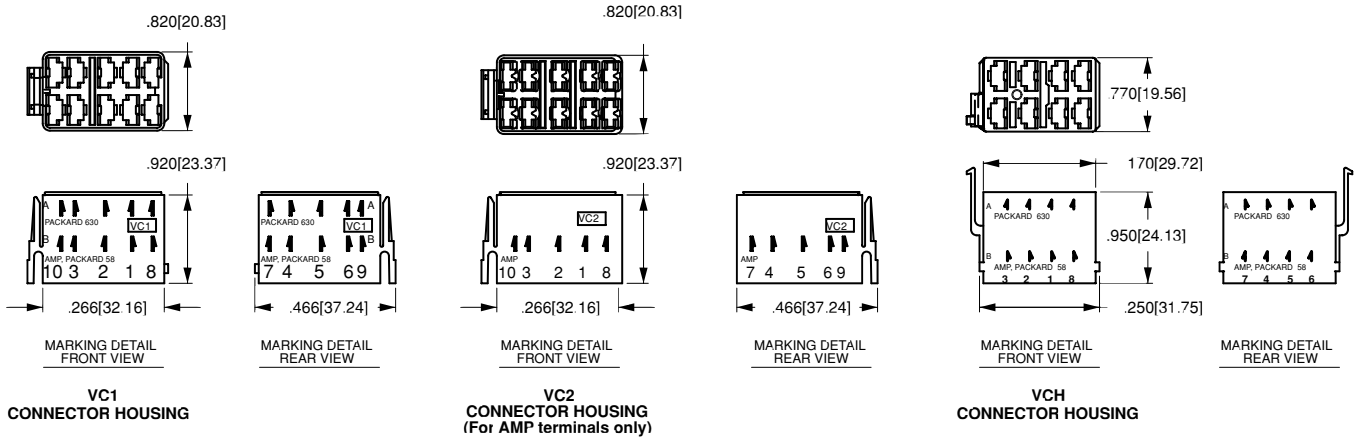

Contura X Boot

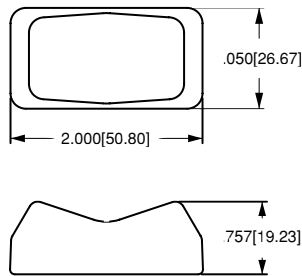

VB1-01
CONTURA X BOOT

Contura II, III, IV & V Actuator Removal Tool

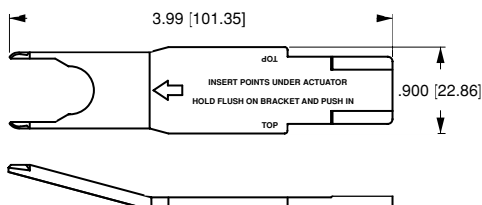

VRT
ACTUATOR REMOVAL
TOOL
(For flush bracket)



Contura Mounting Panels

Dimensional Specifications: in. [mm]

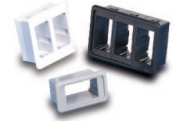
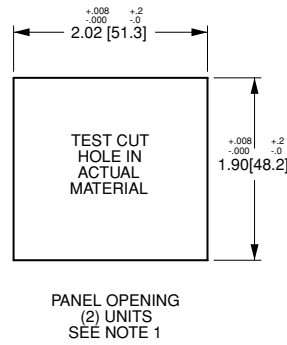
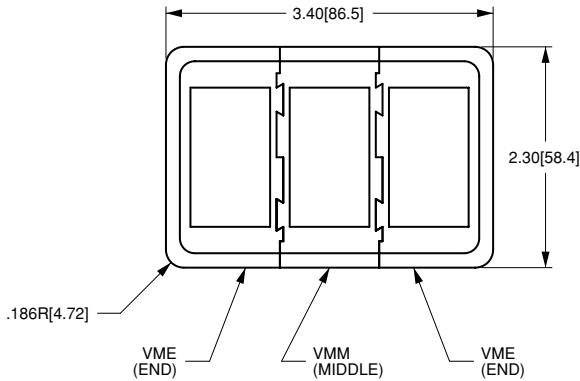

PANEL THICKNESS:
TOLERANCE:

- .062[1.57]
- .093[2.36]
- .125[3.17]
- .187[4.75]
- .250[6.35]
- .375[9.52]

NOTES:

1. FOR ADDITIONAL UNITS, ADD 1.03 [26.2] PER UNIT.
2. FOR MORE THAN 2 V-SERIES SWITCHES, ADD MIDDLE SECTION.

Contura Hole Plug

Dimensional Specifications; in. [mm]

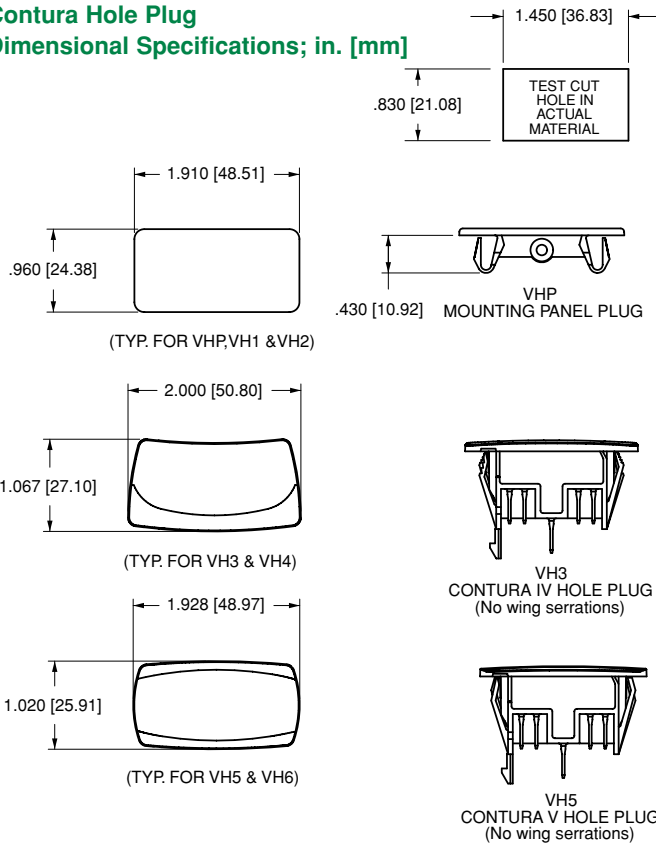

VHP MOUNTING PANEL PLUG

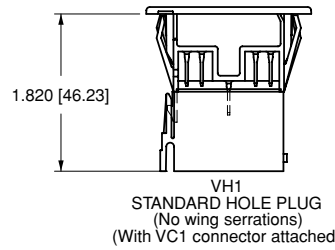

VH2 STANDARD HOLE PLUG (With wing serrations)

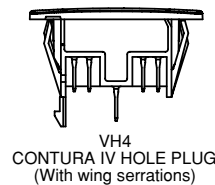
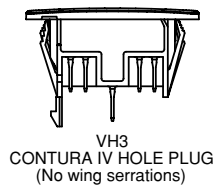

DETAIL VIEW VH3 & VH5 HOLE PLUGS (No wing serrations for ease of removal)

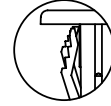
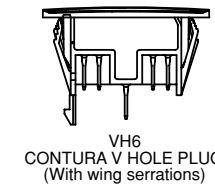
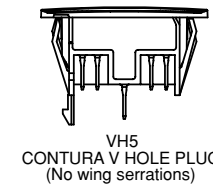

DETAIL VIEW VH2, VH4 & VH6 HOLE PLUGS (With wing serrations)

Additional V-Series Ratings

- | | |
|---|---|
| <p>1 .4VA @ 28VDC Resistive</p> <p>4 10A 250VAC 1/2 HP, 15A 125 VAC 1/2 H, No Agency Listings</p> <p>5 10A 250VAC 1/2 HP, 15A 125 VAC 1/2 HP, UL Recognized, CSA Certified</p> <p>6* 15A 125VAC 1/2 HP, 12(2)A 125 VAC μ T85</p> <p>7* 15A 125VAC 1/2 HP, 12(6)A 125 VAC T85</p> <p>8* 10A 250VAC, 15A 125VAC, 1/2 HP 125-250VAC, 12(2)A 250 VAC μ T85</p> <p>9* 10A 250VAC, 15A 125VAC, 1/2 HP 125-250VAC, 12(6)A 250 VAC T85</p> <p>B 15A 24V</p> <p>C 20A 18V</p> <p>D 20A 12V</p> <p>E 20A 14V, 10A 14VT (circuits 1, 4, A, & D only)</p> <p>F 10A 14V, 6A, 14VT (circuit G only)</p> <p>G 20A 6V</p> <p>H 20A 3V</p> | <p>L 15A 125 VAC, 10A 250VAC, 1/2 HP 125-250 VAC; 6A 125 VAC L</p> <p>M .4VA/20A 12V (combi-contact)
(combination gold/silver contacts for borderline dry circuit applications)</p> <p>N .4VA/15A 24V (combi-contact)
(combination gold/silver contacts for borderline dry circuit applications)</p> |
|---|---|

NOTES

Consult factory to determine availability for individual circuits.
 * Ratings 6 - 9 are UL, CSA, VDE, DEMKO, SEMKO, NEMKO, FIMKO & BEAB certified, require terminations A or B for double pole circuits, & are not available with illumination circuits 4, 8, D, J, N, & T or with wire lead or solder lug terminations. Circuits 1, 4, A & D are not available with rating 6 & 8. Rating 7 & 9 only available with circuits 1, 4, A & D. Circuits 2, 3, 5, 7, 8, K, L are 1/2 HP 250VAC only with rating 8. Ratings 6 & 7 must specify lamp code 1 (125VAC neon). Ratings 8 & 9 must specify lamp code 2 (250VAC neon). Rating L available with circuits 1, 4, A & D only.



**Стандарт
Электрон
Связь**

Мы молодая и активно развивающаяся компания в области поставок электронных компонентов. Мы поставляем электронные компоненты отечественного и импортного производства напрямую от производителей и с крупнейших складов мира.

Благодаря сотрудничеству с мировыми поставщиками мы осуществляем комплексные и плановые поставки широчайшего спектра электронных компонентов.

Собственная эффективная логистика и склад в обеспечивает надежную поставку продукции в точно указанные сроки по всей России.

Мы осуществляем техническую поддержку нашим клиентам и предпродажную проверку качества продукции. На все поставляемые продукты мы предоставляем гарантию .

Осуществляем поставки продукции под контролем ВП МО РФ на предприятия военно-промышленного комплекса России , а также работаем в рамках 275 ФЗ с открытием отдельных счетов в уполномоченном банке. Система менеджмента качества компании соответствует требованиям ГОСТ ISO 9001.

Минимальные сроки поставки, гибкие цены, неограниченный ассортимент и индивидуальный подход к клиентам являются основой для выстраивания долгосрочного и эффективного сотрудничества с предприятиями радиоэлектронной промышленности, предприятиями ВПК и научно-исследовательскими институтами России.

С нами вы становитесь еще успешнее!

Наши контакты:

Телефон: +7 812 627 14 35

Электронная почта: sales@st-electron.ru

Адрес: 198099, Санкт-Петербург,
Промышленная ул, дом № 19, литера Н,
помещение 100-Н Офис 331