

# 74AHC1G17; 74AHCT1G17

Single Schmitt trigger buffer

Rev. 2 — 5 October 2016

Product data sheet

## 1. General description

---

The 74AHC1G17 and 74AHCT1G17 are single buffers with Schmitt-trigger inputs. Inputs are overvoltage tolerant. This feature allows the use of these devices as translators in mixed voltage environments.

The AHC device has CMOS input switching levels and supply voltage range 2 V to 5.5 V.

The AHCT device has TTL input switching levels and supply voltage range 4.5 V to 5.5 V.

## 2. Features and benefits

---

- Symmetrical output impedance
- High noise immunity
- ESD protection:
  - ◆ HBM JESD22-A114E: exceeds 2000 V
  - ◆ MM JESD22-A115-A: exceeds 200 V
  - ◆ CDM JESD22-C101C: exceeds 1000 V
- Low power dissipation
- Balanced propagation delays
- Specified from  $-40\text{ }^{\circ}\text{C}$  to  $+125\text{ }^{\circ}\text{C}$

## 3. Applications

---

- Wave and pulse shapers
- Astable multivibrators
- Monostable multivibrators

## 4. Ordering information

Table 1. Ordering information

Type number	Package			Version
	Temperature range	Name	Description	
74AHC1G17GW	-40 °C to +125 °C	TSSOP5	plastic thin shrink small outline package; 5 leads; body width 1.25 mm	SOT353-1
74AHCT1G17GW				
74AHC1G17GV	-40 °C to +125 °C	SC-74A	plastic surface-mounted package; 5 leads	SOT753
74AHCT1G17GV				

## 5. Marking

Table 2. Marking codes

Type number	Marking code <sup>[1]</sup>
74AHC1G17GW	AJ
74AHCT1G17GW	CJ
74AHC1G17GV	A17
74AHCT1G17GV	C17

[1] The pin 1 indicator is located on the lower left corner of the device, below the marking code.

## 6. Functional diagram

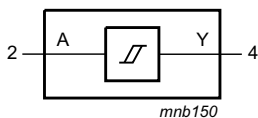


Fig 1. Logic symbol

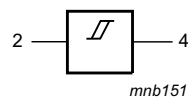


Fig 2. IEC logic symbol

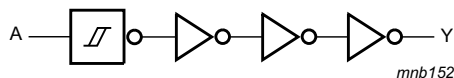


Fig 3. Logic diagram

## 7. Pinning information

### 7.1 Pinning

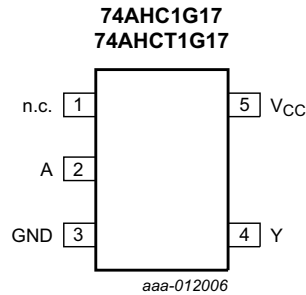


Fig 4. Pin configuration SOT353-1 and SOT753

### 7.2 Pin description

Table 3. Pin description

Symbol	Pin	Description
n.c.	1	not connected
A	2	data input
GND	3	ground (0 V)
Y	4	data output
V <sub>CC</sub>	5	supply voltage

## 8. Functional description

Table 4. Function table

*H = HIGH voltage level; L = LOW voltage level*

Input	Output
A	Y
L	L
H	H

## 9. Limiting values

**Table 5. Limiting values**

In accordance with the Absolute Maximum Rating System (IEC 60134).

Symbol	Parameter	Conditions	Min	Max	Unit
$V_{CC}$	supply voltage		-0.5	+7.0	V
$V_I$	input voltage		-0.5	+7.0	V
$I_{IK}$	input clamping current	$V_I < -0.5$ V	-20	-	mA
$I_{OK}$	output clamping current	$V_O < -0.5$ V or $V_O > V_{CC} + 0.5$ V <a href="#">[1]</a>	-	$\pm 20$	mA
$I_O$	output current	$-0.5$ V $< V_O < V_{CC} + 0.5$ V	-	$\pm 25$	mA
$I_{CC}$	supply current		-	75	mA
$I_{GND}$	ground current		-75	-	mA
$T_{stg}$	storage temperature		-65	+150	°C
$P_{tot}$	total power dissipation	$T_{amb} = -40$ °C to +125 °C <a href="#">[2]</a>	-	250	mW

[1] The input and output voltage ratings may be exceeded if the input and output current ratings are observed.

[2] For TSSOP5 and SC-74A packages: above 87.5 °C the value of  $P_{tot}$  derates linearly with 4.0 mW/K.

## 10. Recommended operating conditions

**Table 6. Recommended operating conditions**

Voltages are referenced to GND (ground = 0 V).

Symbol	Parameter	Conditions	74AHC1G17			74AHCT1G17			Unit
			Min	Typ	Max	Min	Typ	Max	
$V_{CC}$	supply voltage		2.0	5.0	5.5	4.5	5.0	5.5	V
$V_I$	input voltage		0	-	5.5	0	-	5.5	V
$V_O$	output voltage		0	-	$V_{CC}$	0	-	$V_{CC}$	V
$T_{amb}$	ambient temperature		-40	+25	+125	-40	+25	+125	°C

## 11. Static characteristics

**Table 7. Static characteristics**

Voltages are referenced to GND (ground = 0 V).

Symbol	Parameter	Conditions	25 °C			-40 °C to +85 °C		-40 °C to +125 °C		Unit
			Min	Typ	Max	Min	Max	Min	Max	
<b>74AHC1G17</b>										
V <sub>OH</sub>	HIGH-level output voltage	V <sub>I</sub> = V <sub>T+</sub> or V <sub>T-</sub>								
		I <sub>O</sub> = -50 μA; V <sub>CC</sub> = 2.0 V	1.9	2.0	-	1.9	-	1.9	-	V
		I <sub>O</sub> = -50 μA; V <sub>CC</sub> = 3.0 V	2.9	3.0	-	2.9	-	2.9	-	V
		I <sub>O</sub> = -50 μA; V <sub>CC</sub> = 4.5 V	4.4	4.5	-	4.4	-	4.4	-	V
		I <sub>O</sub> = -4.0 mA; V <sub>CC</sub> = 3.0 V	2.58	-	-	2.48	-	2.40	-	V
		I <sub>O</sub> = -8.0 mA; V <sub>CC</sub> = 4.5 V	3.94	-	-	3.8	-	3.70	-	V
V <sub>OL</sub>	LOW-level output voltage	V <sub>I</sub> = V <sub>T+</sub> or V <sub>T-</sub>								
		I <sub>O</sub> = 50 μA; V <sub>CC</sub> = 2.0 V	-	0	0.1	-	0.1	-	0.1	V
		I <sub>O</sub> = 50 μA; V <sub>CC</sub> = 3.0 V	-	0	0.1	-	0.1	-	0.1	V
		I <sub>O</sub> = 50 μA; V <sub>CC</sub> = 4.5 V	-	0	0.1	-	0.1	-	0.1	V
		I <sub>O</sub> = 4.0 mA; V <sub>CC</sub> = 3.0 V	-	-	0.36	-	0.44	-	0.55	V
		I <sub>O</sub> = 8.0 mA; V <sub>CC</sub> = 4.5 V	-	-	0.36	-	0.44	-	0.55	V
I <sub>I</sub>	input leakage current	V <sub>I</sub> = 5.5 V or GND; V <sub>CC</sub> = 0 V to 5.5 V	-	-	0.1	-	1.0	-	2.0	μA
I <sub>CC</sub>	supply current	V <sub>I</sub> = V <sub>CC</sub> or GND; I <sub>O</sub> = 0 A; V <sub>CC</sub> = 5.5 V	-	-	1.0	-	10	-	40	μA
C <sub>I</sub>	input capacitance		-	1.5	10	-	10	-	10	pF
<b>74AHCT1G17</b>										
V <sub>OH</sub>	HIGH-level output voltage	V <sub>I</sub> = V <sub>T+</sub> or V <sub>T-</sub> ; V <sub>CC</sub> = 4.5 V								
		I <sub>O</sub> = -50 μA	4.4	4.5	-	4.4	-	4.4	-	V
		I <sub>O</sub> = -8.0 mA	3.94	-	-	3.8	-	3.70	-	V
V <sub>OL</sub>	LOW-level output voltage	V <sub>I</sub> = V <sub>T+</sub> or V <sub>T-</sub> ; V <sub>CC</sub> = 4.5 V								
		I <sub>O</sub> = 50 μA	-	0	0.1	-	0.1	-	0.1	V
		I <sub>O</sub> = 8.0 mA	-	-	0.36	-	0.44	-	0.55	V
I <sub>I</sub>	input leakage current	V <sub>I</sub> = 5.5 V or GND; V <sub>CC</sub> = 0 V to 5.5 V	-	-	0.1	-	1.0	-	2.0	μA
I <sub>CC</sub>	supply current	V <sub>I</sub> = V <sub>CC</sub> or GND; I <sub>O</sub> = 0 A; V <sub>CC</sub> = 5.5 V	-	-	1.0	-	10	-	40	μA
ΔI <sub>CC</sub>	additional supply current	per input pin; V <sub>I</sub> = 3.4 V; other inputs at V <sub>CC</sub> or GND; I <sub>O</sub> = 0 A; V <sub>CC</sub> = 5.5 V	-	-	1.35	-	1.5	-	1.5	mA
C <sub>I</sub>	input capacitance		-	1.5	10	-	10	-	10	pF

## 11.1 Transfer characteristics

**Table 8. Transfer characteristics**

At recommended operating conditions; voltages are referenced to GND (ground = 0 V). See [Figure 7](#) and [Figure 8](#).

Symbol	Parameter	Conditions	25 °C			−40 °C to +85 °C		−40 °C to +125 °C		Unit
			Min	Typ	Max	Min	Max	Min	Max	
<b>74AHC1G17</b>										
V <sub>T+</sub>	positive-going threshold voltage	V <sub>CC</sub> = 3.0 V	-	-	2.2	-	2.2	-	2.2	V
		V <sub>CC</sub> = 4.5 V	-	-	3.15	-	3.15	-	3.15	V
		V <sub>CC</sub> = 5.5 V	-	-	3.85	-	3.85	-	3.85	V
V <sub>T-</sub>	negative-going threshold voltage	V <sub>CC</sub> = 3.0 V	0.9	-	-	0.9	-	0.9	-	V
		V <sub>CC</sub> = 4.5 V	1.35	-	-	1.35	-	1.35	-	V
		V <sub>CC</sub> = 5.5 V	1.65	-	-	1.65	-	1.65	-	V
V <sub>H</sub>	hysteresis voltage	V <sub>CC</sub> = 3.0 V	0.3	-	1.2	0.3	1.2	0.25	1.2	V
		V <sub>CC</sub> = 4.5 V	0.4	-	1.4	0.4	1.4	0.35	1.4	V
		V <sub>CC</sub> = 5.5 V	0.5	-	1.6	0.5	1.6	0.45	1.6	V
<b>74AHCT1G17</b>										
V <sub>T+</sub>	positive-going threshold voltage	V <sub>CC</sub> = 4.5 V	-	-	2.0	-	2.0	-	2.0	V
		V <sub>CC</sub> = 5.5 V	-	-	2.0	-	2.0	-	2.0	V
V <sub>T-</sub>	negative-going threshold voltage	V <sub>CC</sub> = 4.5 V	0.5	-	-	0.5	-	0.5	-	V
		V <sub>CC</sub> = 5.5 V	0.6	-	-	0.6	-	0.6	-	V
V <sub>H</sub>	hysteresis voltage	V <sub>CC</sub> = 4.5 V	0.4	-	1.4	0.4	1.4	0.35	1.4	V
		V <sub>CC</sub> = 5.5 V	0.4	-	1.6	0.4	1.6	0.35	1.6	V

## 12. Dynamic characteristics

**Table 9. Dynamic characteristics**

$GND = 0\text{ V}$ ;  $t_r = t_f \leq 3.0\text{ ns}$ . For waveform, see [Figure 5](#). For test circuit, see [Figure 6](#).

Symbol	Parameter	Conditions	25 °C			−40 °C to +85 °C		−40 °C to +125 °C		Unit
			Min	Typ	Max	Min	Max	Min	Max	
<b>74AHC1G17</b>										
$t_{pd}$	propagation delay	A to Y <a href="#">[1]</a>								
		$V_{CC} = 3.0\text{ V to }3.6\text{ V}$ <a href="#">[2]</a>								
		$C_L = 15\text{ pF}$	-	4.2	12.8	1.0	15.0	1.0	16.5	ns
		$C_L = 50\text{ pF}$	-	6.0	16.3	1.0	18.5	1.0	20.5	ns
		$V_{CC} = 4.5\text{ V to }5.5\text{ V}$ <a href="#">[3]</a>								
		$C_L = 15\text{ pF}$	-	3.2	8.6	1.0	10.0	1.0	11.0	ns
$C_{PD}$	power dissipation capacitance	$C_L = 50\text{ pF}$	-	4.6	10.6	1.0	12.0	1.0	13.5	ns
		per buffer; $C_L = 50\text{ pF}$ ; $f = 1\text{ MHz}$ ; $V_I = GND\text{ to }V_{CC}$ <a href="#">[4]</a>	-	12	-	-	-	-	-	pF
<b>74AHCT1G17</b>										
$t_{pd}$	propagation delay	A to Y <a href="#">[1][3]</a>								
		$V_{CC} = 4.5\text{ V to }5.5\text{ V}$								
		$C_L = 15\text{ pF}$	-	4.1	7.0	1.0	8.0	1.0	9.0	ns
$C_{PD}$	power dissipation capacitance	$C_L = 50\text{ pF}$	-	5.9	8.5	1.0	10.0	1.0	11.0	ns
		per buffer; $V_I = GND\text{ to }V_{CC}$ <a href="#">[4]</a>	-	13	-	-	-	-	-	pF

[1]  $t_{pd}$  is the same as  $t_{PLH}$  and  $t_{PHL}$ .

[2] Typical values are measured at  $V_{CC} = 3.3\text{ V}$ .

[3] Typical values are measured at  $V_{CC} = 5.0\text{ V}$ .

[4]  $C_{PD}$  is used to determine the dynamic power dissipation  $P_D$  ( $\mu\text{W}$ ).

$$P_D = C_{PD} \times V_{CC}^2 \times f_i + \sum(C_L \times V_{CC}^2 \times f_o) \text{ where:}$$

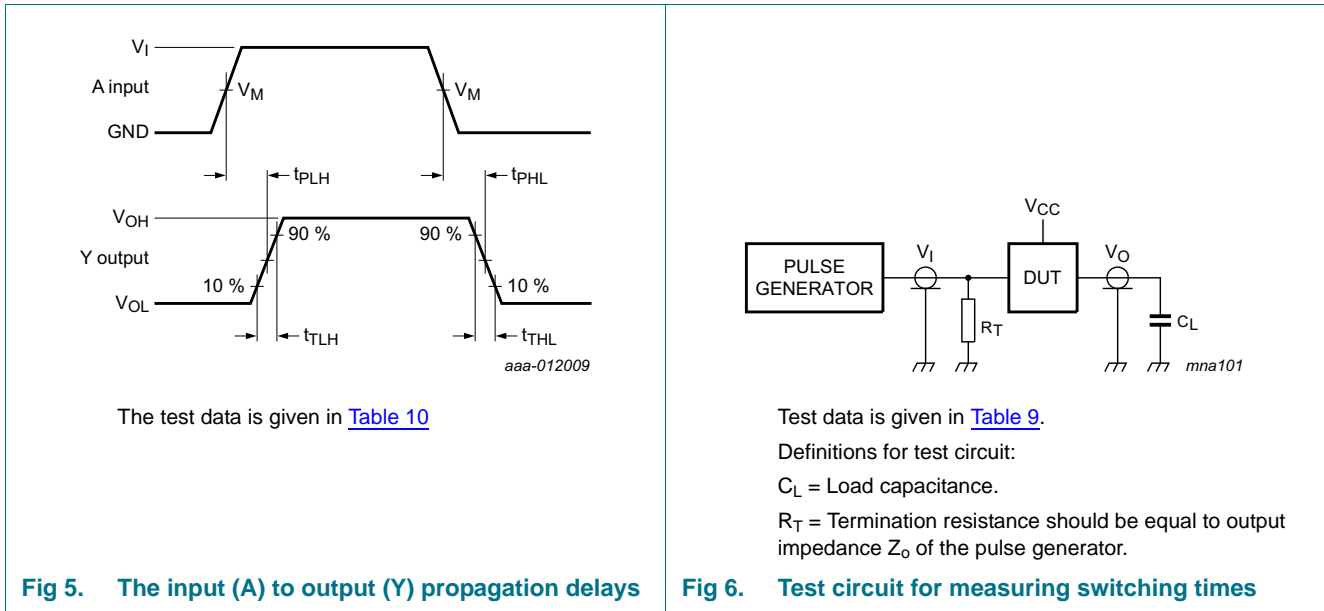
$f_i$  = input frequency in MHz;

$f_o$  = output frequency in MHz;

$C_L$  = output load capacitance in pF;

$V_{CC}$  = supply voltage in Volts.

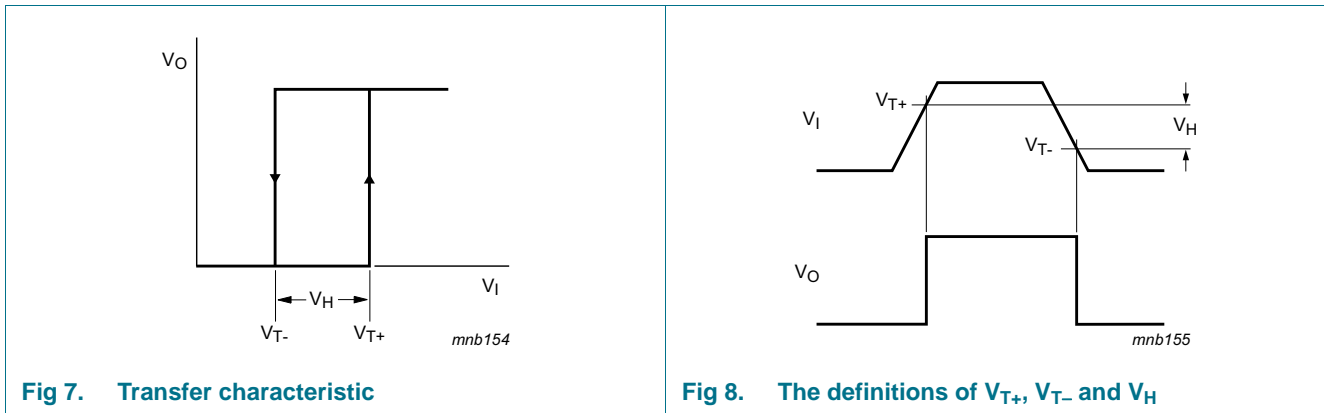
## 13. Waveforms



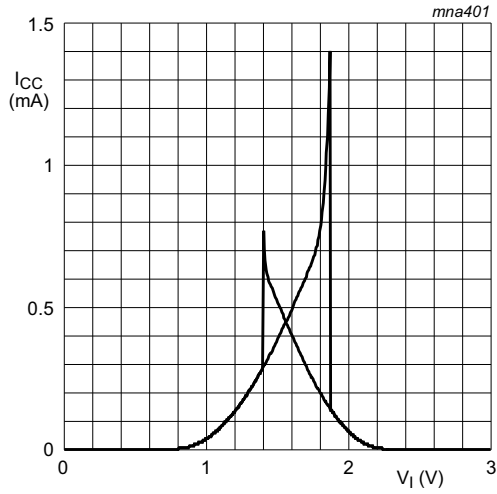
**Table 10. Test data**

Type number	Input		Output
	$V_I$	$V_M$	$V_M$
74AHC1G17	GND to $V_{CC}$	$0.5 \times V_{CC}$	$0.5 \times V_{CC}$
74AHCT1G17	GND to 3.0 V	1.5 V	$0.5 \times V_{CC}$

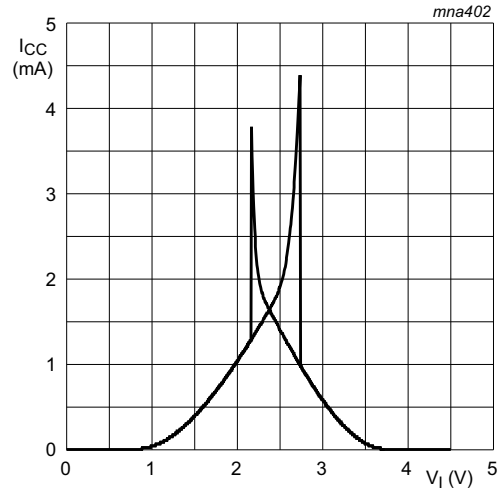
### 13.1 Transfer characteristic waveforms



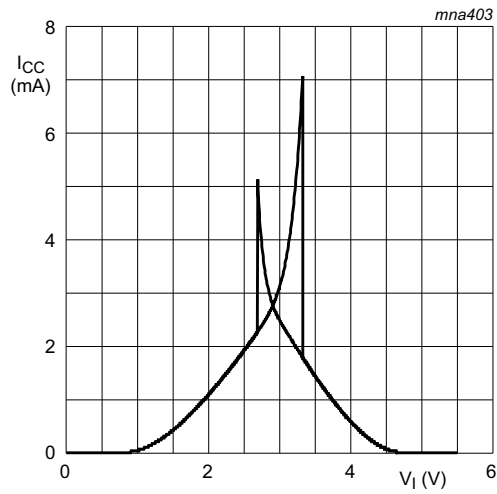




**Fig 9.** Typical 74AHC1G17 transfer characteristics;  $V_{CC} = 3.0\text{ V}$



**Fig 10.** Typical 74AHC1G17 transfer characteristics;  $V_{CC} = 4.5\text{ V}$



**Fig 11.** Typical 74AHC1G17 transfer characteristics;  $V_{CC} = 5.5\text{ V}$

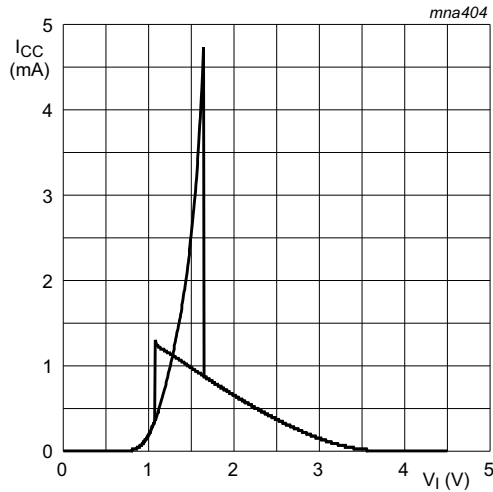


Fig 12. Typical 74AHCT1G17 transfer characteristics;  
 $V_{CC} = 4.5 \text{ V}$

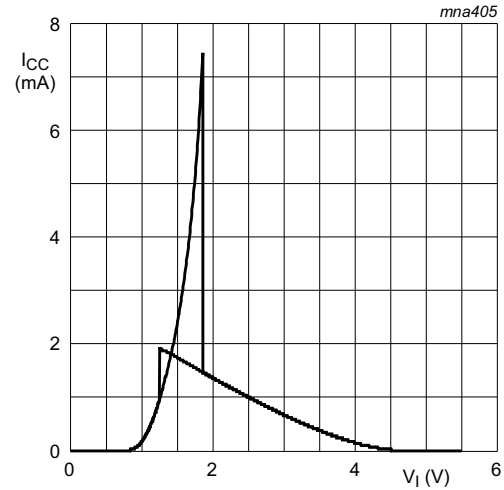


Fig 13. Typical 74AHCT1G17 transfer characteristics;  
 $V_{CC} = 5.5 \text{ V}$

## 14. Application information

The slow input rise and fall times cause additional power dissipation, which can be calculated using the following formula:

$$P_{\text{add}} = f_i \times (t_r \times \Delta I_{\text{CC(AV)}} + t_f \times \Delta I_{\text{CC(AV)}}) \times V_{\text{CC}} \text{ where:}$$

$P_{\text{add}}$  = additional power dissipation ( $\mu\text{W}$ );

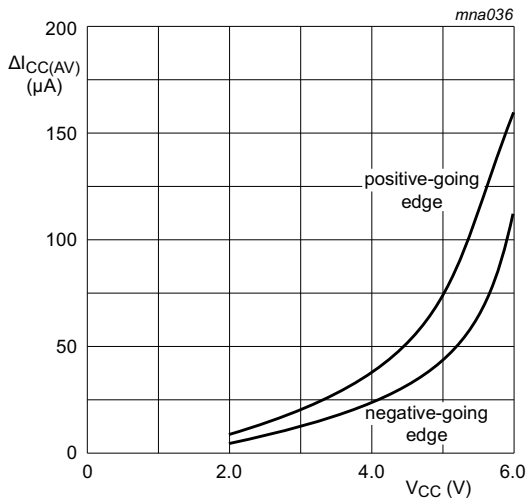
$f_i$  = input frequency (MHz);

$t_r$  = input rise time (ns); 10 % to 90 %;

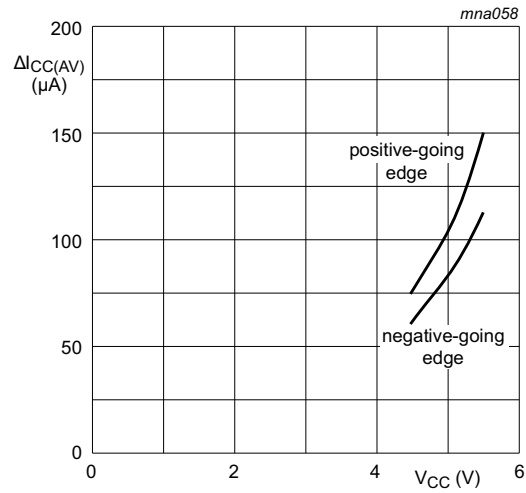
$t_f$  = input fall time (ns); 90 % to 10 %;

$\Delta I_{\text{CC(AV)}}$  = average additional supply current ( $\mu\text{A}$ ).

Average additional  $I_{\text{CC}}$  differs with positive or negative input transitions, as shown in [Figure 14](#) and [Figure 15](#).



**Fig 14. Average additional I<sub>CC</sub> for 74AHC1G17 Schmitt trigger devices; linear change of V<sub>I</sub> between 0.1V<sub>CC</sub> to 0.9V<sub>CC</sub>**



**Fig 15. Average additional I<sub>CC</sub> for 74AHCT1G17 Schmitt trigger devices; linear change of V<sub>I</sub> between 0.1V<sub>CC</sub> to 0.9V<sub>CC</sub>**

## 15. Package outline

TSSOP5: plastic thin shrink small outline package; 5 leads; body width 1.25 mm

SOT353-1

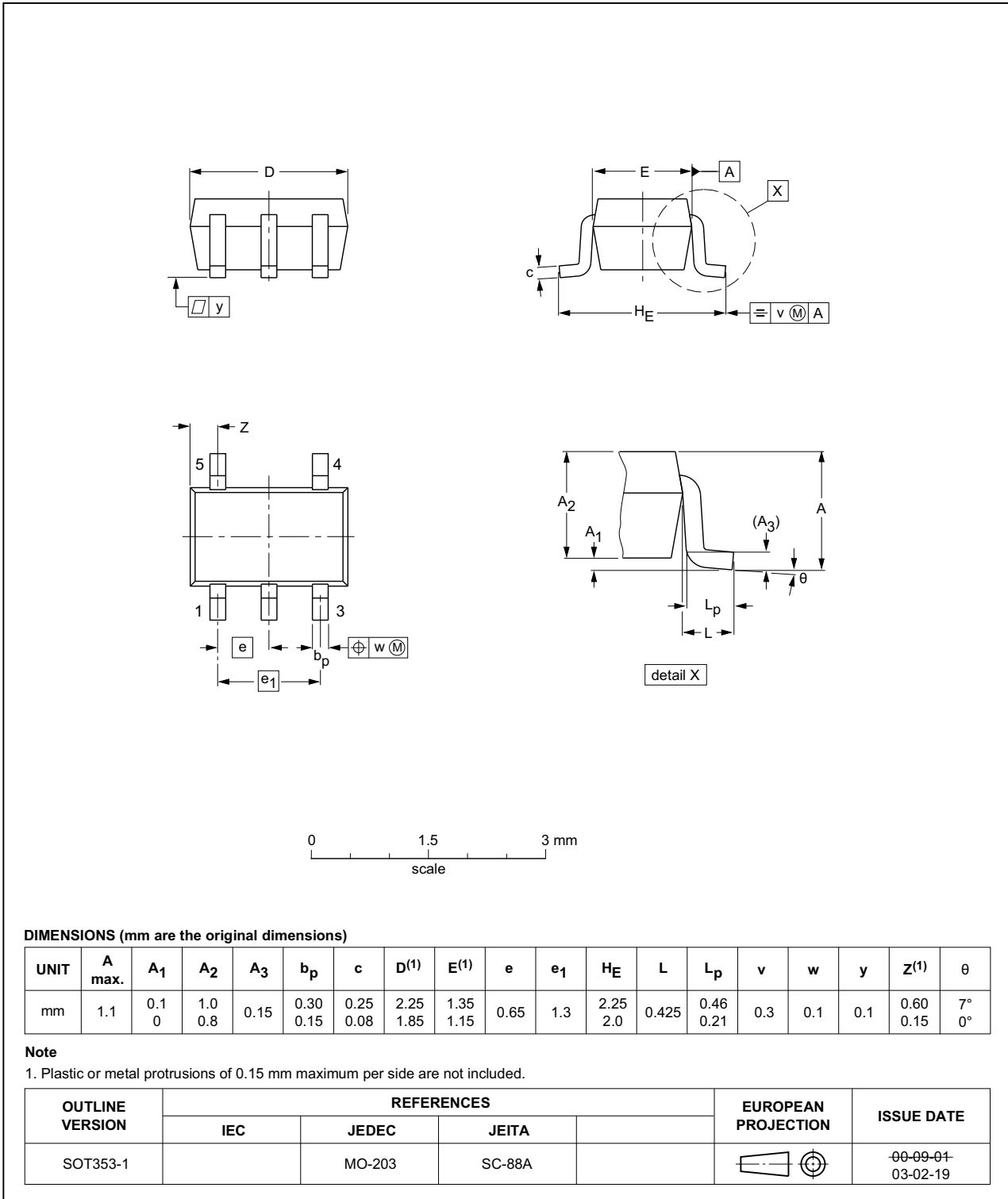


Fig 16. Package outline SOT353-1 (TSSOP5)

Plastic surface-mounted package; 5 leads

SOT753

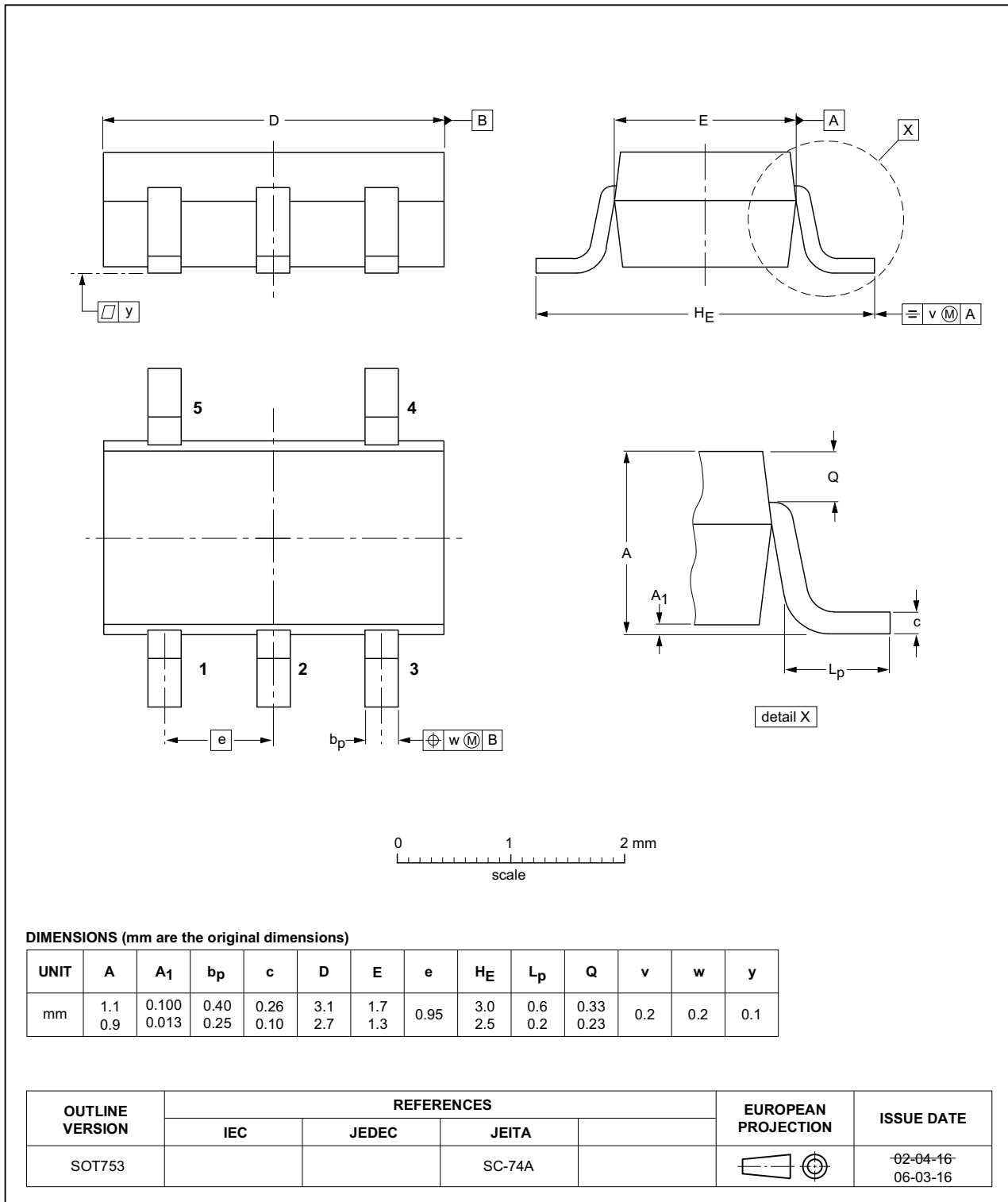


Fig 17. Package outline SOT753 (SC-74A)

## 16. Abbreviations

Table 11. Abbreviations

Acronym	Description
CDM	Charged Device Model
CMOS	Complementary Metal-Oxide Semiconductor
DUT	Device Under Test
ESD	ElectroStatic Discharge
HBM	Human Body Model
MM	Machine Model
TTL	Transistor-Transistor Logic

## 17. Revision history

Table 12. Revision history

Document ID	Release date	Data sheet status	Change notice	Supersedes
74AHC_AHCT1G17 v.2	20161005	Product data sheet	-	74AHC_AHCT1G17 v.1
Modifications:	<ul style="list-style-type: none"> <li>Type numbers 74AHC1G17GF, 74AHC1G17GM, 74AHCT1G17GF and 74AHCT1G17GM removed.</li> </ul>			
74AHC_AHCT1G17 v.1	20140318	Product data sheet	-	-

## 18. Legal information

### 18.1 Data sheet status

Document status <sup>[1][2]</sup>	Product status <sup>[3]</sup>	Definition
Objective [short] data sheet	Development	This document contains data from the objective specification for product development.
Preliminary [short] data sheet	Qualification	This document contains data from the preliminary specification.
Product [short] data sheet	Production	This document contains the product specification.

[1] Please consult the most recently issued document before initiating or completing a design.

[2] The term 'short data sheet' is explained in section "Definitions".

[3] The product status of device(s) described in this document may have changed since this document was published and may differ in case of multiple devices. The latest product status information is available on the Internet at URL <http://www.nexperia.com>.

### 18.2 Definitions

**Draft** — The document is a draft version only. The content is still under internal review and subject to formal approval, which may result in modifications or additions. Nexperia does not give any representations or warranties as to the accuracy or completeness of information included herein and shall have no liability for the consequences of use of such information.

**Short data sheet** — A short data sheet is an extract from a full data sheet with the same product type number(s) and title. A short data sheet is intended for quick reference only and should not be relied upon to contain detailed and full information. For detailed and full information see the relevant full data sheet, which is available on request via the local Nexperia sales office. In case of any inconsistency or conflict with the short data sheet, the full data sheet shall prevail.

**Product specification** — The information and data provided in a Product data sheet shall define the specification of the product as agreed between Nexperia and its customer, unless Nexperia and customer have explicitly agreed otherwise in writing. In no event however, shall an agreement be valid in which the Nexperia product is deemed to offer functions and qualities beyond those described in the Product data sheet.

### 18.3 Disclaimers

**Limited warranty and liability** — Information in this document is believed to be accurate and reliable. However, Nexperia does not give any representations or warranties, expressed or implied, as to the accuracy or completeness of such information and shall have no liability for the consequences of use of such information. Nexperia takes no responsibility for the content in this document if provided by an information source outside of Nexperia.

In no event shall Nexperia be liable for any indirect, incidental, punitive, special or consequential damages (including - without limitation - lost profits, lost savings, business interruption, costs related to the removal or replacement of any products or rework charges) whether or not such damages are based on tort (including negligence), warranty, breach of contract or any other legal theory.

Notwithstanding any damages that customer might incur for any reason whatsoever, Nexperia's aggregate and cumulative liability towards customer for the products described herein shall be limited in accordance with the *Terms and conditions of commercial sale* of Nexperia.

**Right to make changes** — Nexperia reserves the right to make changes to information published in this document, including without limitation specifications and product descriptions, at any time and without notice. This document supersedes and replaces all information supplied prior to the publication hereof.

**Suitability for use** — Nexperia products are not designed, authorized or warranted to be suitable for use in life support, life-critical or safety-critical systems or equipment, nor in applications where failure or malfunction of a Nexperia product can reasonably be expected to result in personal injury, death or severe property or environmental damage. Nexperia and its suppliers accept no liability for inclusion and/or use of Nexperia products in such equipment or applications and therefore such inclusion and/or use is at the customer's own risk.

**Applications** — Applications that are described herein for any of these products are for illustrative purposes only. Nexperia makes no representation or warranty that such applications will be suitable for the specified use without further testing or modification.

Customers are responsible for the design and operation of their applications and products using Nexperia products, and Nexperia accepts no liability for any assistance with applications or customer product design. It is customer's sole responsibility to determine whether the Nexperia product is suitable and fit for the customer's applications and products planned, as well as for the planned application and use of customer's third party customer(s). Customers should provide appropriate design and operating safeguards to minimize the risks associated with their applications and products.

Nexperia does not accept any liability related to any default, damage, costs or problem which is based on any weakness or default in the customer's applications or products, or the application or use by customer's third party customer(s). Customer is responsible for doing all necessary testing for the customer's applications and products using Nexperia products in order to avoid a default of the applications and the products or of the application or use by customer's third party customer(s). Nexperia does not accept any liability in this respect.

**Limiting values** — Stress above one or more limiting values (as defined in the Absolute Maximum Ratings System of IEC 60134) will cause permanent damage to the device. Limiting values are stress ratings only and (proper) operation of the device at these or any other conditions above those given in the Recommended operating conditions section (if present) or the Characteristics sections of this document is not warranted. Constant or repeated exposure to limiting values will permanently and irreversibly affect the quality and reliability of the device.

**Terms and conditions of commercial sale** — Nexperia products are sold subject to the general terms and conditions of commercial sale, as published at <http://www.nexperia.com/profile/terms>, unless otherwise agreed in a valid written individual agreement. In case an individual agreement is concluded only the terms and conditions of the respective agreement shall apply. Nexperia hereby expressly objects to applying the customer's general terms and conditions with regard to the purchase of Nexperia products by customer.

**No offer to sell or license** — Nothing in this document may be interpreted or construed as an offer to sell products that is open for acceptance or the grant, conveyance or implication of any license under any copyrights, patents or other industrial or intellectual property rights.

**Export control** — This document as well as the item(s) described herein may be subject to export control regulations. Export might require a prior authorization from competent authorities.

**Non-automotive qualified products** — Unless this data sheet expressly states that this specific Nexperia product is automotive qualified, the product is not suitable for automotive use. It is neither qualified nor tested in accordance with automotive testing or application requirements. Nexperia accepts no liability for inclusion and/or use of non-automotive qualified products in automotive equipment or applications.

In the event that customer uses the product for design-in and use in automotive applications to automotive specifications and standards, customer (a) shall use the product without Nexperia's warranty of the product for such automotive applications, use and specifications, and (b) whenever customer uses the product for automotive applications beyond

Nexperia's specifications such use shall be solely at customer's own risk, and (c) customer fully indemnifies Nexperia for any liability, damages or failed product claims resulting from customer design and use of the product for automotive applications beyond Nexperia's standard warranty and Nexperia's product specifications.

**Translations** — A non-English (translated) version of a document is for reference only. The English version shall prevail in case of any discrepancy between the translated and English versions.

## 18.4 Trademarks

Notice: All referenced brands, product names, service names and trademarks are the property of their respective owners.

## 19. Contact information

For more information, please visit: <http://www.nexperia.com>

For sales office addresses, please send an email to: [salesaddresses@nexperia.com](mailto:salesaddresses@nexperia.com)



## 20. Contents

---

<b>1</b>	<b>General description</b> . . . . .	<b>1</b>
<b>2</b>	<b>Features and benefits</b> . . . . .	<b>1</b>
<b>3</b>	<b>Applications</b> . . . . .	<b>1</b>
<b>4</b>	<b>Ordering information</b> . . . . .	<b>2</b>
<b>5</b>	<b>Marking</b> . . . . .	<b>2</b>
<b>6</b>	<b>Functional diagram</b> . . . . .	<b>2</b>
<b>7</b>	<b>Pinning information</b> . . . . .	<b>3</b>
7.1	Pinning . . . . .	3
7.2	Pin description . . . . .	3
<b>8</b>	<b>Functional description</b> . . . . .	<b>3</b>
<b>9</b>	<b>Limiting values</b> . . . . .	<b>4</b>
<b>10</b>	<b>Recommended operating conditions</b> . . . . .	<b>4</b>
<b>11</b>	<b>Static characteristics</b> . . . . .	<b>5</b>
11.1	Transfer characteristics . . . . .	6
<b>12</b>	<b>Dynamic characteristics</b> . . . . .	<b>7</b>
<b>13</b>	<b>Waveforms</b> . . . . .	<b>8</b>
13.1	Transfer characteristic waveforms . . . . .	8
<b>14</b>	<b>Application information</b> . . . . .	<b>10</b>
<b>15</b>	<b>Package outline</b> . . . . .	<b>12</b>
<b>16</b>	<b>Abbreviations</b> . . . . .	<b>14</b>
<b>17</b>	<b>Revision history</b> . . . . .	<b>14</b>
<b>18</b>	<b>Legal information</b> . . . . .	<b>15</b>
18.1	Data sheet status . . . . .	15
18.2	Definitions . . . . .	15
18.3	Disclaimers . . . . .	15
18.4	Trademarks . . . . .	16
<b>19</b>	<b>Contact information</b> . . . . .	<b>16</b>
<b>20</b>	<b>Contents</b> . . . . .	<b>17</b>



## Стандарт Электрон Связь

Мы молодая и активно развивающаяся компания в области поставок электронных компонентов. Мы поставляем электронные компоненты отечественного и импортного производства напрямую от производителей и с крупнейших складов мира.

Благодаря сотрудничеству с мировыми поставщиками мы осуществляем комплексные и плановые поставки широчайшего спектра электронных компонентов.

Собственная эффективная логистика и склад в обеспечивает надежную поставку продукции в точно указанные сроки по всей России.

Мы осуществляем техническую поддержку нашим клиентам и предпродажную проверку качества продукции. На все поставляемые продукты мы предоставляем гарантию .

Осуществляем поставки продукции под контролем ВП МО РФ на предприятия военно-промышленного комплекса России , а также работаем в рамках 275 ФЗ с открытием отдельных счетов в уполномоченном банке. Система менеджмента качества компании соответствует требованиям ГОСТ ISO 9001.

Минимальные сроки поставки, гибкие цены, неограниченный ассортимент и индивидуальный подход к клиентам являются основой для выстраивания долгосрочного и эффективного сотрудничества с предприятиями радиоэлектронной промышленности, предприятиями ВПК и научно-исследовательскими институтами России.

С нами вы становитесь еще успешнее!

### Наши контакты:

**Телефон:** +7 812 627 14 35

**Электронная почта:** [sales@st-electron.ru](mailto:sales@st-electron.ru)

**Адрес:** 198099, Санкт-Петербург,  
Промышленная ул, дом № 19, литера Н,  
помещение 100-Н Офис 331