

ISL88011, ISL88012, ISL88013, ISL88014, ISL88015

5 Ld Voltage Supervisors with Adjustable Power-On Reset, Dual Voltage Monitoring or Watchdog Timer Capability

FN8093
Rev 5.00
December 4, 2015

The ISL88011, ISL88012, ISL88013, ISL88014, ISL88015 family of devices offer both fixed and/or adjustable voltage-monitoring that combine popular functions such as Power-On reset control, watchdog timer, supply voltage supervision, and manual reset assertion in a small 5 Ld SOT-23 package.

Unique features on the ISL88013 and ISL88015 include a watchdog timer with a 51s start-up timeout and a 1.6s normal timeout duration. On the ISL88011 and ISL88014, users can increase the nominal 200ms Power-On reset timeout delay by adding an external capacitor to the C_{POR} pin. Both fixed and adjustable voltage monitors are provided by the ISL88012. Complementary active-low and active-high reset outputs are available on the ISL88011, ISL88012 and ISL88013 devices. All devices provide manual reset capability (see "Product Features Table" on page 5).

Seven preprogrammed reset threshold voltages accurate to $\pm 1.5\%$ over temperature are offered (see "Ordering Information" on page 3). The ISL88012, ISL88014 and ISL88015 have a user-adjustable voltage input available for custom monitoring of any voltage down to 0.6V. All parts are specifically designed for low power consumption and high threshold accuracy.

Features

- Single/dual voltage monitoring supervisors
- Fixed-voltage options allow precise monitoring of +2.5V, +3.0V, +3.3V, and +5.0V power supplies
- Dual supervisor has one fixed voltage input and another that is user-adjustable down to 0.6V.
- Both RST and \overline{RST} outputs available
- Adjustable POR timeout delay options
- Watchdog timer with 1.6s normal and 51s start-up timeout durations
- Manual reset input on all devices
- Reset signal valid down to $V_{DD} = 1V$
- Accurate $\pm 1.5\%$ voltage threshold
- Immune to power-supply transients
- Ultra low 5.5 μA supply current
- Small 5 Ld SOT-23 Pb-Free package
- Pb-Free (RoHS Compliant)

Applications

- Process control systems
- Intelligent instruments
- Embedded control systems
- Computer systems
- Critical μP and μC power monitoring
- Portable/battery-powered equipment
- PDA and handheld PC devices

Pinouts

ISL88011
(5 LD SOT-23)
TOP VIEW

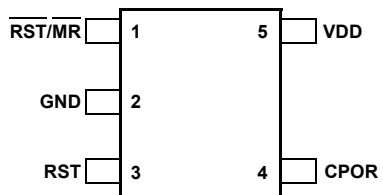

ISL88012
(5 LD SOT-23)
TOP VIEW

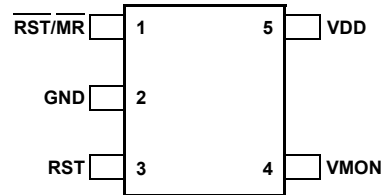

ISL88013
(5 LD SOT-23)
TOP VIEW

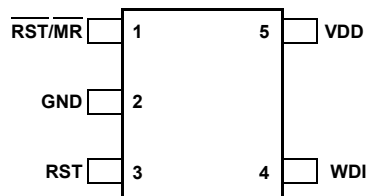

ISL88014
(5 LD SOT-23)
TOP VIEW

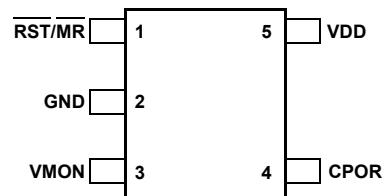

ISL88015
(5 LD SOT-23)
TOP VIEW

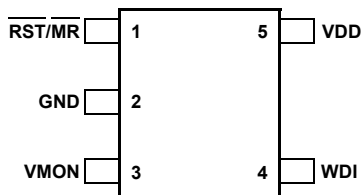

Ordering Information

PART NUMBER (Notes 1, 2, 3)	PART MARKING (Note 4)	V _{THVDD} (V)	V _{THVMON} (V)	TEMPERATURE RANGE (°C)	PACKAGE TAPE AND REEL (Pb-free)	PKG. DWG. #
ISL88011IH546Z-TK	AGU	4.64	N/A	-40 to +85	5 Ld SOT-23	P5.064
ISL88011IH546Z-T7A	AGU	4.64	N/A	-40 to +85	5 Ld SOT-23	P5.064
ISL88011IH544Z-TK	AGV	4.38	N/A	-40 to +85	5 Ld SOT-23	P5.064
ISL88011IH544Z-T7A	AGV	4.38	N/A	-40 to +85	5 Ld SOT-23	P5.064
ISL88011IH531Z-TK	AGW	3.09	N/A	-40 to +85	5 Ld SOT-23	P5.064
ISL88011IH531Z-T7A	AGW	3.09	N/A	-40 to +85	5 Ld SOT-23	P5.064
ISL88011IH529Z-TK	AGX	2.92	N/A	-40 to +85	5 Ld SOT-23	P5.064
ISL88011IH529Z-T7A	AGX	2.92	N/A	-40 to +85	5 Ld SOT-23	P5.064
ISL88011IH526Z-TK	AGY	2.63	N/A	-40 to +85	5 Ld SOT-23	P5.064
ISL88011IH526Z-T7A	AGY	2.63	N/A	-40 to +85	5 Ld SOT-23	P5.064
ISL88011IH523Z-TK	AGZ	2.32	N/A	-40 to +85	5 Ld SOT-23	P5.064
ISL88011IH523Z-T7A	AGZ	2.32	N/A	-40 to +85	5 Ld SOT-23	P5.064
ISL88011IH522Z-TK (No longer available, recommended replacement: ISL88013IH522Z-TK)	AHE	2.19	N/A	-40 to +85	5 Ld SOT-23	P5.064
ISL88011IH522Z-T7A (No longer available, recommended replacement: ISL88013IH522Z-T7A)	AHE	2.19	N/A	-40 to +85	5 Ld SOT-23	P5.064
ISL88012IH546Z-TK (No longer available or supported)	AHF	4.64	0.6 (Note 2)	-40 to +85	5 Ld SOT-23	P5.064
ISL88012IH546Z-T7A (No longer available or supported)	AHF	4.64	0.6 (Note 2)	-40 to +85	5 Ld SOT-23	P5.064
ISL88012IH544Z-TK (No longer available or supported)	AHG	4.38	0.6 (Note 2)	-40 to +85	5 Ld SOT-23	P5.064
ISL88012IH544Z-T7A (No longer available or supported)	AHG	4.38	0.6 (Note 2)	-40 to +85	5 Ld SOT-23	P5.064
ISL88012IH531Z-TK (No longer available or supported)	AHH	3.09	0.6 (Note 2)	-40 to +85	5 Ld SOT-23	P5.064
ISL88012IH531Z-T7A (No longer available or supported)	AHH	3.09	0.6 (Note 2)	-40 to +85	5 Ld SOT-23	P5.064
ISL88012IH529Z-TK (No longer available or supported)	AHI	2.92	0.6 (Note 2)	-40 to +85	5 Ld SOT-23	P5.064
ISL88012IH529Z-T7A (No longer available or supported)	AHI	2.92	0.6 (Note 2)	-40 to +85	5 Ld SOT-23	P5.064
ISL88012IH526Z-TK (No longer available or supported)	AHJ	2.63	0.6 (Note 2)	-40 to +85	5 Ld SOT-23	P5.064
ISL88012IH526Z-T7A (No longer available or supported)	AHJ	2.63	0.6 (Note 2)	-40 to +85	5 Ld SOT-23	P5.064
ISL88012IH523Z-TK (No longer available or supported)	AHK	2.32	0.6 (Note 2)	-40 to +85	5 Ld SOT-23	P5.064
ISL88012IH523Z-T7A (No longer available or supported)	AHK	2.32	0.6 (Note 2)	-40 to +85	5 Ld SOT-23	P5.064
ISL88012IH522Z-TK (No longer available or supported)	AHL	2.19	0.6 (Note 2)	-40 to +85	5 Ld SOT-23	P5.064
ISL88012IH522Z-T7A (No longer available or supported)	AHL	2.19	0.6 (Note 2)	-40 to +85	5 Ld SOT-23	P5.064
ISL88013IH546Z-TK (No longer available, recommended replacement: ISL88011IH546Z-TK)	AHM	4.64	N/A	-40 to +85	5 Ld SOT-23	P5.064
ISL88013IH546Z-T7A (No longer available, recommended replacement: ISL88011IH546Z-T7A)	AHM	4.64	N/A	-40 to +85	5 Ld SOT-23	P5.064
ISL88013IH544Z-TK	AHN	4.38	N/A	-40 to +85	5 Ld SOT-23	P5.064
ISL88013IH544Z-T7A	AHN	4.38	N/A	-40 to +85	5 Ld SOT-23	P5.064
ISL88013IH531Z-TK	AHO	3.09	N/A	-40 to +85	5 Ld SOT-23	P5.064
ISL88013IH531Z-T7A	AHO	3.09	N/A	-40 to +85	5 Ld SOT-23	P5.064
ISL88013IH529Z-TK	AHP	2.92	N/A	-40 to +85	5 Ld SOT-23	P5.064
ISL88013IH529Z-T7A	AHP	2.92	N/A	-40 to +85	5 Ld SOT-23	P5.064

Ordering Information (Continued)

PART NUMBER (Notes 1, 2, 3)	PART MARKING (Note 4)	V _{THVDD} (V)	V _{THVMON} (V)	TEMPERATURE RANGE (°C)	PACKAGE TAPE AND REEL (Pb-free)	PKG. DWG. #
ISL88013IH526Z-TK	AHQ	2.63	N/A	-40 to +85	5 Ld SOT-23	P5.064
ISL88013IH526Z-T7A	AHQ	2.63	N/A	-40 to +85	5 Ld SOT-23	P5.064
ISL88013IH523Z-TK (No longer available, recommended replacement: ISL88011IH523Z-TK)	AHR	2.32	N/A	-40 to +85	5 Ld SOT-23	P5.064
ISL88013IH523Z-T7A (No longer available, recommended replacement: ISL88011IH523Z-T7A)	AHR	2.32	N/A	-40 to +85	5 Ld SOT-23	P5.064
ISL88013IH522Z-TK	AHS	2.19	N/A	-40 to +85	5 Ld SOT-23	P5.064
ISL88013IH522Z-T7A	AHS	2.19	N/A	-40 to +85	5 Ld SOT-23	P5.064
ISL88014IH5Z-TK	AHT	N/A	0.6 (Note 2)	-40 to +85	5 Ld SOT-23	P5.064
ISL88014IH5Z-T7A	AHT	N/A	0.6 (Note 2)	-40 to +85	5 Ld SOT-23	P5.064
ISL88015IH5Z-TK (No longer available or supported)	AHU	N/A	0.6 (Note 2)	-40 to +85	5 Ld SOT-23	P5.064
ISL88015IH5Z-T7A (No longer available or supported)	AHU	N/A	0.6 (Note 2)	-40 to +85	5 Ld SOT-23	P5.064
ISL88011EVAL1Z	ISL88011 Evaluation Card					
ISL88013EVAL1Z	ISL88013 Evaluation Card					
ISL88014EVAL1Z	ISL88014 Evaluation Card					

NOTES:

- These Intersil Pb-free plastic packaged products employ special Pb-free material sets, molding compounds/die attach materials, and 100% matte tin plate plus anneal (e3 termination finish, which is RoHS compliant and compatible with both SnPb and Pb-free soldering operations). Intersil Pb-free products are MSL classified at Pb-free peak reflow temperatures that meet or exceed the Pb-free requirements of IPC/JEDEC J STD-020.
- The voltage trip point can be adjusted to be greater than 0.6V using 2 external resistors. By default, the V_{THVMON} trip point is 0.6V if no external resistors are used.
- For Moisture Sensitivity Level (MSL), please see device information page for [ISL88011](#), [ISL88012](#), [ISL88013](#), [ISL88014](#), [ISL88015](#). For more information on MSL please see techbrief [TB363](#).
- The part marking is located on the bottom of the part.

Functional Block Diagrams



Product Features Table

FUNCTION	ISL88011	ISL88012	ISL88013	ISL88014	ISL88015
Active-Low Reset ($\overline{\text{RST}}$)	x	x	x	x	x
Active-High Reset (RST)	x	x	x		
Watchdog Timer (WDI)			x		x
Dual Voltage Supervision		x			
Adjustable POR Timeout (C_{POR})	x			x	
Manual Reset Input ($\overline{\text{MR}}$)	x	x	x	x	x
Fixed Trip Point Voltage	x	x	x		
Adjustable Trip Point Voltage		x		x	x

Pin Descriptions

PIN					NAME	FUNCTION
ISL88011	ISL88012	ISL88013	ISL88014	ISL88015		
1	1	1	1	1	$\overline{\text{RST}}/\overline{\text{MR}}$	Combined Active-Low Reset Output and Manual Reset Input
2	2	2	2	2	GND	Ground
	4		3	3	VMON	Adjustable Threshold Voltage Input
3	3	3			RST	Active-High Reset Output
4			4		C_{POR}	Adjustable POR Timeout Delay Input
		4		4	WDI	Watchdog Timer Input
5	5	5	5	5	V_{DD}	Supply Voltage and Monitored Input

Absolute Maximum Ratings

Temperature Under Bias	-40°C to +125°C
Storage Temperature	-65°C to +150°C
Voltage on any pin with respect to GND	-1.0V to +7V
DC Output Current	5mA
ESD Rating	
Human Body Model (Tested per JESD22-A114)	2500V
Charged Device Model (Tested per JESD22-C101E)	1200V
Machine Model (Tested per JESD22-A115)	250V

Thermal Information

Thermal Resistance (Typical)	θ_{JA} (°C/W)
5 Ld SOT-23 (Note 5)	190
Maximum Junction Temperature (Plastic Package)	+125°C
Maximum Storage Temperature Range	-65°C to +150°C
Pb-Free Reflow Profile	see link below
	http://www.intersil.com/pbfree/Pb-FreeReflow.asp

Recommended Operating Conditions

Temperature Range (Industrial)	-40°C to +85°C
Pull-up Resistance (R_{PU})	5k Ω to 100k Ω

CAUTION: Do not operate at or near the maximum ratings listed for extended periods of time. Exposure to such conditions may adversely impact product reliability and result in failures not covered by warranty.

NOTE:

5. θ_{JA} is measured with the component mounted on a high effective thermal conductivity test board in free air. See Tech Brief [TB379](#) for details.

Electrical Specifications Over the recommended operating conditions unless otherwise specified, $R_{PU} = 10k\Omega$.

SYMBOL	PARAMETER	TEST CONDITIONS	MIN	TYP	MAX	UNITS
V_{DD}	Supply Voltage Range		2.0		5.5	V
I_{DD}	Supply Current for ISL88011, ISL88012, ISL88013	$V_{DD} = 5.0V$		8	11.5	μA
		$V_{DD} = 3.3V$		7	10	μA
		$V_{DD} = 2.5V$		5.5	9	μA
		Supply Current for ISL88014, ISL88015	$V_{DD} = 3.3V$		4.5	8
I_{LI}	Input Leakage Current (VMON)				100	nA
I_{LO}	Output Leakage Current (VMON)				100	nA
VOLTAGE THRESHOLDS						
V_{THVDD}	Fixed V_{DD} Voltage Trip Point	ISL88011, ISL88012, ISL88013IH546	4.57	4.64	4.71	V
		ISL88011, ISL88012, ISL88013IH544	4.31	4.38	4.45	V
		ISL88011, ISL88012, ISL88013IH531	3.04	3.09	3.14	V
		ISL88011, ISL88012, ISL88013IH529	2.88	2.92	2.96	V
		ISL88011, ISL88012, ISL88013IH526	2.59	2.63	2.67	V
		ISL88011, ISL88012, ISL88013IH523	2.29	2.32	2.35	V
		ISL88011, ISL88012, ISL88013IH522	2.16	2.19	2.22	V
V_{THVDD} HYST	Hysteresis at V_{DD} Input	$V_{THVDD} = 4.64V$		46		mV
		$V_{THVDD} = 4.38V$		44		mV
		$V_{THVDD} = 3.09V$		31		mV
		$V_{THVDD} = 2.92V$		29		mV
		$V_{THVDD} = 2.63V$		26		mV
		$V_{THVDD} = 2.32V$		23		mV
		$V_{THVDD} = 2.19V$		22		mV
V_{THVMON}	Adj. Reset Voltage Trip Point (Note 6)	$V_{THVDD} = 4.64V$	599	605	611	mV
		$V_{THVDD} = 4.38V$	597	603	609	mV
		$V_{THVDD} = 3.09V$	589	595	601	mV
		$V_{THVDD} = 2.92V$	589	595	601	mV
		$V_{THVDD} = 2.63V$	589	595	601	mV
		$V_{THVDD} = 2.32V$	597	603	609	mV
		$V_{THVDD} = 2.19V$	597	603	609	mV

Electrical Specifications Over the recommended operating conditions unless otherwise specified, $R_{PU} = 10k\Omega$. (Continued)

SYMBOL	PARAMETER	TEST CONDITIONS	MIN	TYP	MAX	UNITS
V_{THVMON}	Adj. Reset Voltage Trip Point (Note 7)		594	600	606	mV
V_{THVMON} $HYST$	Hysteresis Voltage (Notes 6, 7)			3		mV
RESET						
V_{OL}	Reset Output Voltage Low	$V_{DD} \geq 3.3V$, Sinking 0.5mA		0.05	0.40	V
		$V_{DD} < 3.3V$, Sinking 0.5mA		0.05	0.40	V
V_{OH}	Reset Output Voltage High	$V_{DD} \geq 3.3V$, Sourcing 0.4mA	$V_{DD}-0.6$	$V_{DD}-0.4$		V
		$V_{DD} < 3.3V$, Sourcing 0.4mA	$V_{DD}-0.6$	$V_{DD}-0.4$		V
t_{RPD}	V_{TH} to Reset Asserted Delay			60		μs
t_{POR}	POR Timeout Delay	ISL88012, ISL88013, ISL88015	140	200	260	ms
		ISL88011, ISL88014 with $C_{POR} = OPEN$	200	250		ms
C_{LOAD}	Load Capacitance on Reset Pins			5		pF
MANUAL RESET						
V_{MR}	\overline{MR} Input Voltage		0		100	mV
t_{MR}	\overline{MR} Minimum Pulse Width		1			μs
WATCHDOG TIMER (Note 8)						
Start t_{WDT}	Start-up Watchdog Timeout Period		32	51	64	sec
t_{WDT}	Normal Watchdog Timeout Period		1.0	1.6	2.0	sec
t_{WDPS}	WDI Minimum Pulse Width		100			ns
V_{IL}	Watchdog Input Voltage Low				$0.3 \times V_{DD}$	V
V_{IH}	Watchdog Input Voltage High		$0.85 \times V_{DD}$			V
I_{WDT}	Watchdog Input Current				100	nA

NOTES:

6. Applies to ISL88012.
7. Applies to ISL88014 and ISL88015.
8. Applies to ISL88013 and ISL88015.

Pin Description

RST

The push-pull RST output is set to V_{DD} (HIGH) listed in the following:

1. The device is first powered up.
2. Either V_{DD} or the voltage on VMON falls below their respective minimum voltage sense levels.
3. \overline{MR} is asserted.
4. The watchdog timeout expires.

$\overline{RST}/\overline{MR}$

This pin functions as both a reset output and a manual reset input. The \overline{RST} output functions identically to the complementary RST output but is an open drain output that is pulled to GND (LOW) when reset is asserted. The \overline{MR} input is an active-low debounced input to which a user can connect a push-button to add manual reset capability or drive with active low signal from a controller.

V_{DD}

The V_{DD} pin is the power supply terminal. It is monitored by the ISL88011, ISL88012 and ISL88013. For these devices, the voltage at this pin is compared against an internal factory-programmed voltage trip point, V_{THVDD} . A reset is first asserted when the device is initially powered up to

ensure that the power supply has stabilized. Thereafter, reset is again asserted whenever V_{DD} falls below V_{THVDD} . The device is designed with hysteresis to help prevent chattering due to noise.

VMON

The VMON pin on the ISL88012, ISL88014 and ISL88015 is a monitored input voltage that is user-adjustable. The voltage at this pin is compared against an internal 600mV reference voltage (V_{THVMON}) and a reset is asserted whenever the monitored voltage falls below this trip point.

WDI

The Watchdog Input takes an input from a microprocessor and ensures that it periodically toggles the WDI pin, otherwise the internal watchdog timer runs out and reset is asserted. The internal Watchdog Timer is cleared whenever the WDI input pin sees a rising or falling edge or the device is manually reset.

CPOR

The CPOR input pin lets users increase the Power-On Reset timeout delay (t_{POR}) by connecting a capacitor between CPOR and ground. (See Figure 3)

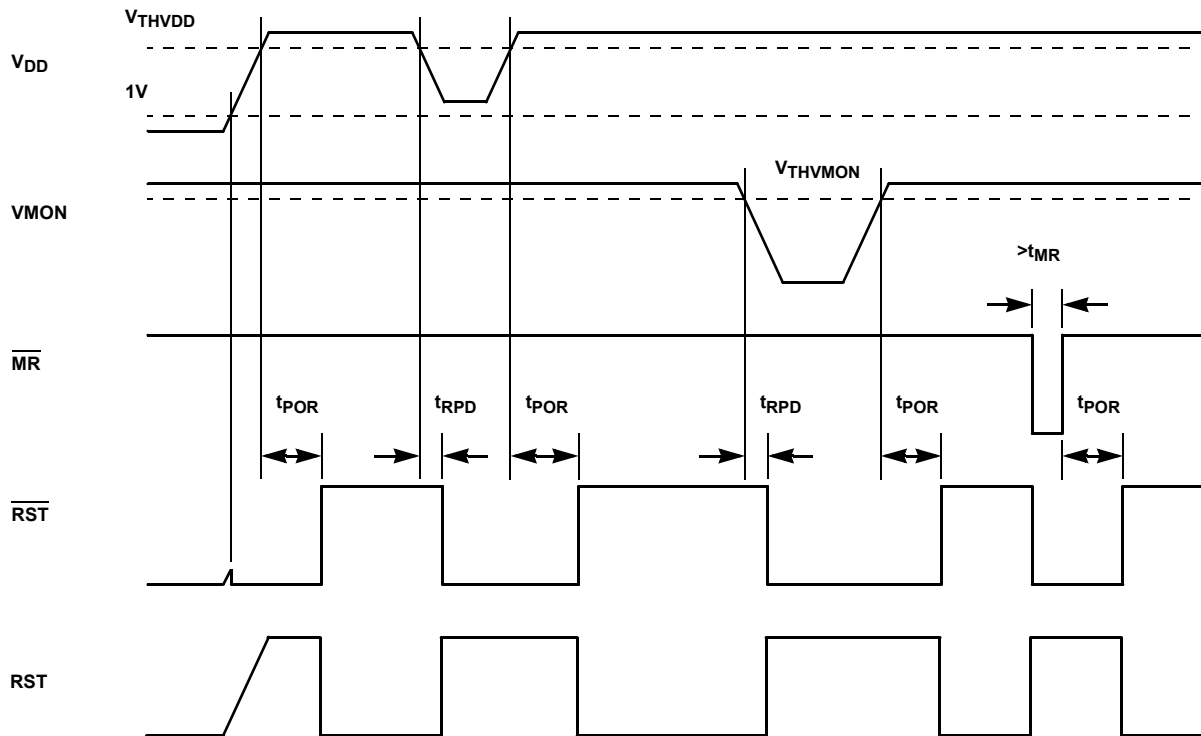

FIGURE 1. VOLTAGE MONITORING TIMING DIAGRAM

Principles of Operation

The ISL88011, ISL88012, ISL88013, ISL88014, ISL88015 devices provide those functions needed for critical voltage monitoring. These features include Power-On Reset control, customizable supply voltage supervision, Watchdog Timer capability, and manual reset assertion. By integrating all of these features into a small 5 Ld SOT-23 package and using only 5.5µA of supply current, the ISL88011, ISL88012, ISL88013, ISL88014, ISL88015 devices can assist in lowering system cost, reducing board space requirements, and increasing the reliability of a system.

Low Voltage Monitoring

During normal operation, these supervisors monitor both the voltage level of V_{DD} (ISL88011, ISL88012, ISL88013) and/or VMON (ISL88012, ISL88014, ISL88015). The device asserts a reset if any of these voltages falls below their respective trip points. The reset signal effectively prevents the system from operating during a power failure or brownout condition. This reset signal remains asserted until V_{DD} and the voltage on VMON exceed their voltage threshold setting for the reset time delay period t_{POR} of 200ms (See Figure 1)

The ISL88012, ISL88014 and ISL88015 allow users to customize the minimum voltage sense level on the VMON input pin. To do this, connect an external resistor divider network to the VMON pin in order to set the trip point to some voltage above 600mV according to the following Equation 1 (See Figure 2).

$$V_{INTRIP} = 0.6 \times \frac{(R_1 + R_2)}{R_2} \quad (\text{EQ. 1})$$



FIGURE 2. USING VMON TO MONITOR V_{IN} VIA RESISTORS

Power-On Reset (POR)

Applying at least 1V to the V_{DD} pin activates a POR circuit which asserts reset (i.e., RST goes HIGH while $\overline{\text{RST}}$ goes LOW). The reset signals remain asserted until the voltage at V_{DD} and/or VMON rise above the minimum voltage sense level for time period t_{POR}. This ensures that the voltages have stabilized.

These reset signals provide several benefits:

- It prevents the system microprocessor from starting to operate with insufficient voltage.
- It prevents the processor from operating prior to stabilization of the oscillator.
- It ensures that the monitored device is held out of operation until internal registers are properly loaded.
- It allows time for an FPGA to download its configuration prior to initialization of the circuit.

Adjusting POR Timeout via C_{POR} Pin

On the ISL88011 and ISL88014, users can adjust the Power-On Reset timeout delay (t_{POR}) up to many times the normal t_{POR} of 250ms. To do this, connect a capacitor between C_{POR} and ground (see Figure 3). For example, connecting a 30pF capacitor to C_{POR} will increase t_{POR} from a typical 250ms to about 2.5s. **NOTE:** Care should be taken in PCB layout and capacitor placement in order to reduce stray capacitance as much as possible, which lengthens the t_{POR} timeout period.

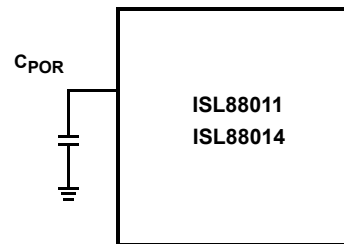

FIGURE 3. ADJUSTING t_{POR} WITH A CAPACITOR

Manual Reset

The manual reset input (\overline{MR}) allows the user to trigger a reset by using a push-button switch. The \overline{MR} input is an active-low debounced input. By connecting a push-button directly from \overline{MR} to ground, the designer adds manual system reset capability (see Figure 4). Reset is asserted if the \overline{MR} pin is pulled low to less than 100mV for 1 μ s or longer while the push-button is closed. After \overline{MR} is released, the reset outputs remain asserted for t_{POR} (200ms) and then released.

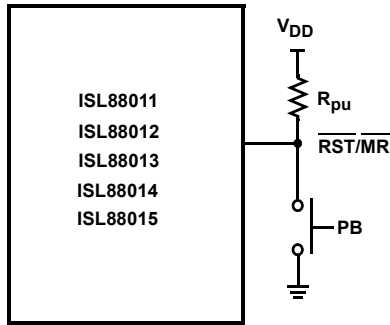

FIGURE 4. CONNECTING A MANUAL RESET PUSH-BUTTON

Watchdog Timer

The Watchdog Timer circuit checks microprocessor activity by monitoring the WDI input pin. The microprocessor must periodically toggle the WDI pin within t_{WDT} (1.6s nominal), otherwise the reset signal is asserted (see Figure 5). Internally, the 1.6s timer is cleared by either a reset or by toggling the WDI input.

Besides the 1.6s default timeout during normal operation, these devices also have a longer 51s timeout for start-up. During this time, a reset cannot be asserted due to the WDI not being toggled. The longer delay at power-on allows an operating system to boot, an FPGA to initialize, or the system software to initialize without the burden of dealing with the Watchdog.

Symbol Table

WAVEFORM	INPUTS	OUTPUTS
	Must be steady	Will be steady
	May change from LOW to HIGH	Will change from LOW to HIGH
	May change from HIGH to LOW	Will change from HIGH to LOW
	Don't Care: Changes Allowed	Changing: State Not Known
	N/A	Center Line is High Impedance

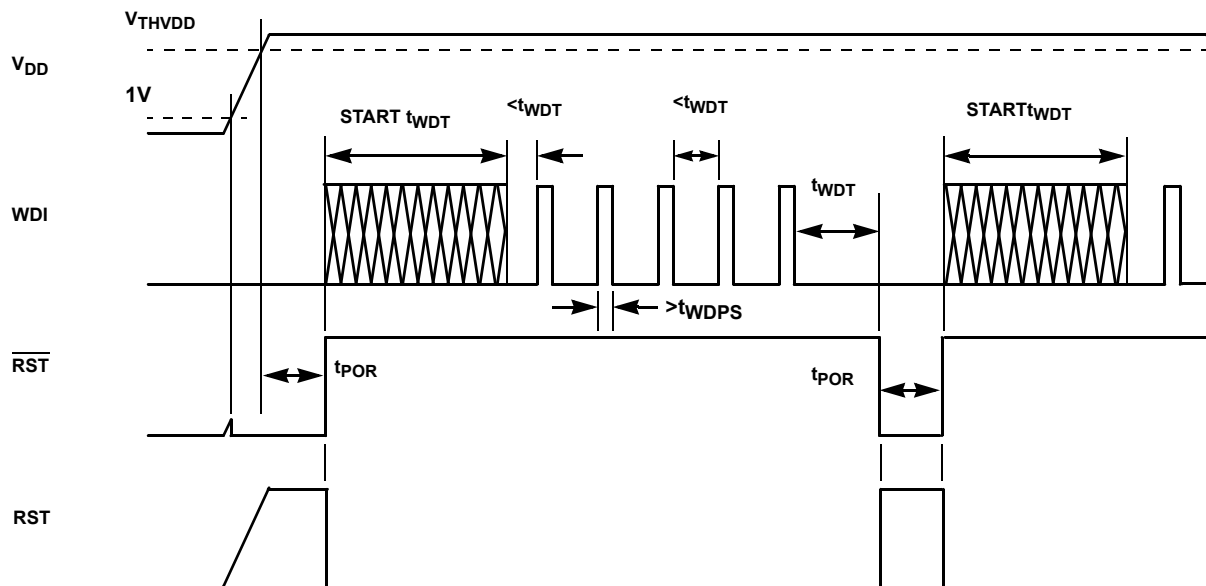

FIGURE 5. WATCHDOG TIMING DIAGRAM

Typical Parametric Performance Curves

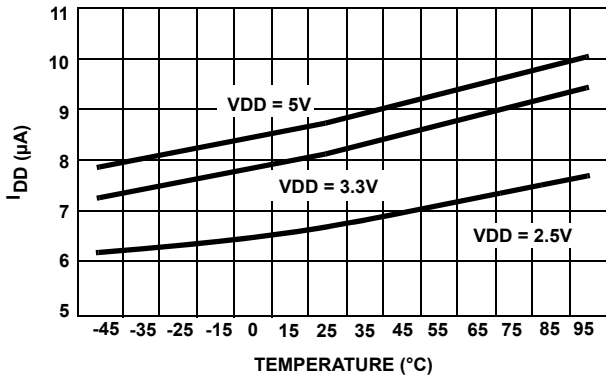

FIGURE 6. I_{DD} (ISL88011, ISL88012, ISL88013) vs TEMPERATURE

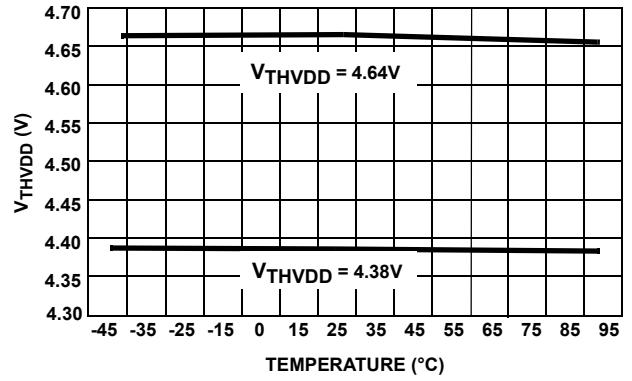

FIGURE 7. V_{THVDD} , $V_{DD} = 5V$ vs TEMPERATURE

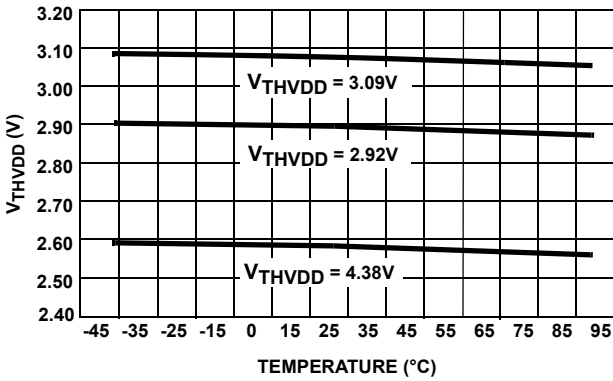

FIGURE 8. V_{THVDD} , $V_{DD} = 3.3V$ vs TEMPERATURE



FIGURE 9. V_{THVDD} , $V_{DD} = 2.5V$ vs TEMPERATURE



FIGURE 10. V_{THVMON} vs TEMPERATURE



FIGURE 11. t_{POR} (C_{POR} OPEN) vs TEMPERATURE

Typical Application Circuits



FIGURE 12. HIGH ACCURACY 12V SUPPLY MONITOR



FIGURE 13. 12V SUPPLY PGOOD or PGOOD

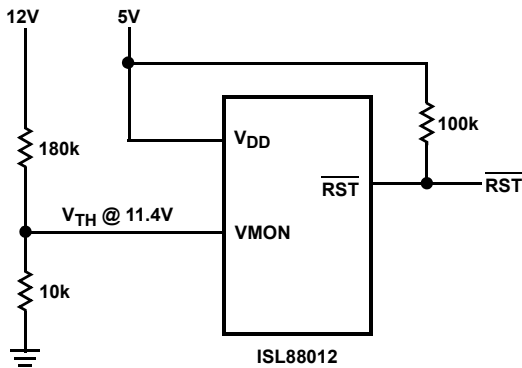

FIGURE 14. MONITOR 5V AND 12V SUPPLIES



PGOOD = HIGH IF $-V < -4.6V$ AND $-V + +V > 9.4$ (abs)

FIGURE 15. +5V AND -5V MONITOR



VOLTAGE OUT OF RANGE = PGOOD LOW

FIGURE 16. OVER/UNDERVOLTAGE MONITOR

ISL8801XEVAL1Z Board Schematics

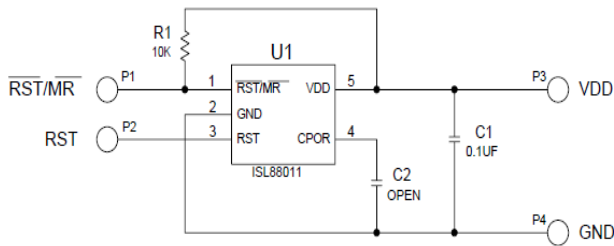

FIGURE 17. ISL88011EVAL1Z

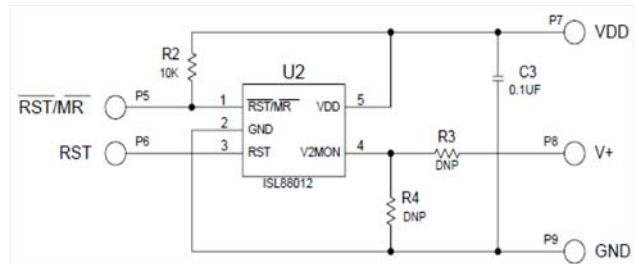

FIGURE 18. ISL88012EVAL1Z

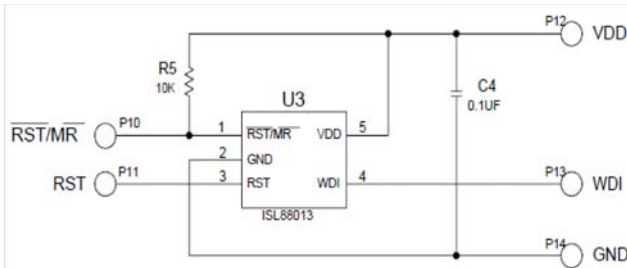

FIGURE 19. ISL88013EVAL1Z

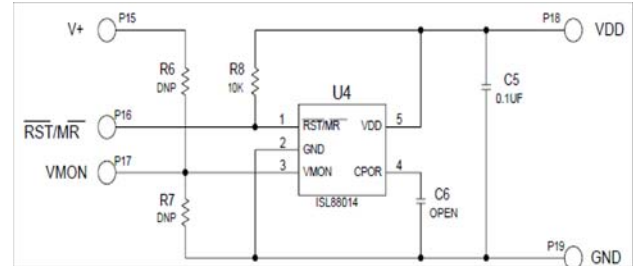

FIGURE 20. ISL88014EVAL1Z

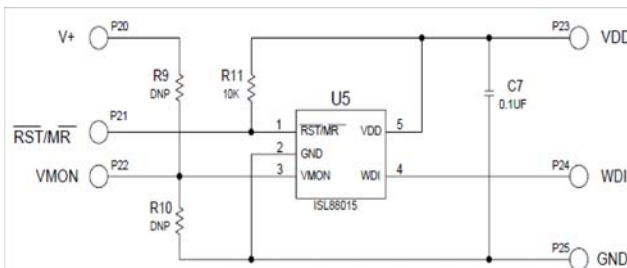

FIGURE 21. ISL88015EVAL1Z



Each of the ISL8801X parts has its own evaluation board provided with minimal customization, allowing the user to program with passive components both the POR timing and adjustable VMON thresholds, where applicable. The ISL88011EVAL1Z, ISL88012EVAL1Z and ISL88013EVAL1Z have a 4.6V Vth part installed.

FIGURE 22. THE TYPICAL ISL8801XEVAL1Z MEASURING 0.5" x 1"

Revision History

The revision history provided is for informational purposes only and is believed to be accurate, but not warranted. Please go to the web to make sure that you have the latest revision.

DATE	REVISION	CHANGE
December 4, 2015	FN8093.5	Updated Ordering Information Table on page 3 and page 4. Added Revision History and About Intersil sections.

About Intersil

Intersil Corporation is a leading provider of innovative power management and precision analog solutions. The company's products address some of the largest markets within the industrial and infrastructure, mobile computing and high-end consumer markets. For the most updated datasheet, application notes, related documentation and related parts, please see the respective product information page found at www.intersil.com.

You may report errors or suggestions for improving this datasheet by visiting www.intersil.com/ask.

Reliability reports are also available from our website at www.intersil.com/support

© Copyright Intersil Americas LLC 2004-2015. All Rights Reserved.
All trademarks and registered trademarks are the property of their respective owners.

For additional products, see www.intersil.com/en/products.html

Intersil products are manufactured, assembled and tested utilizing ISO9001 quality systems as noted in the quality certifications found at www.intersil.com/en/support/qualandreliability.html

Intersil products are sold by description only. Intersil may modify the circuit design and/or specifications of products at any time without notice, provided that such modification does not, in Intersil's sole judgment, affect the form, fit or function of the product. Accordingly, the reader is cautioned to verify that datasheets are current before placing orders. Information furnished by Intersil is believed to be accurate and reliable. However, no responsibility is assumed by Intersil or its subsidiaries for its use; nor for any infringements of patents or other rights of third parties which may result from its use. No license is granted by implication or otherwise under any patent or patent rights of Intersil or its subsidiaries.

For information regarding Intersil Corporation and its products, see www.intersil.com

Package Outline Drawing

P5.064

5 LEAD SMALL OUTLINE TRANSISTOR PLASTIC PACKAGE

Rev 3, 4/11



NOTES:

1. Dimensioning and tolerance per ASME Y14.5M-1994.
2. Package conforms to EIAJ SC-74 and JEDEC MO178AA.
3. Package length and width are exclusive of mold flash, protrusions, or gate burrs.
4. Footlength measured at reference to gauge plane.
5. Lead thickness applies to the flat section of the lead between 0.08mm and 0.15mm from the lead tip.
6. Controlling dimension: MILLIMETER.
Dimensions in () for reference only.



Стандарт Электрон Связь

Мы молодая и активно развивающаяся компания в области поставок электронных компонентов. Мы поставляем электронные компоненты отечественного и импортного производства напрямую от производителей и с крупнейших складов мира.

Благодаря сотрудничеству с мировыми поставщиками мы осуществляем комплексные и плановые поставки широчайшего спектра электронных компонентов.

Собственная эффективная логистика и склад в обеспечивает надежную поставку продукции в точно указанные сроки по всей России.

Мы осуществляем техническую поддержку нашим клиентам и предпродажную проверку качества продукции. На все поставляемые продукты мы предоставляем гарантию .

Осуществляем поставки продукции под контролем ВП МО РФ на предприятия военно-промышленного комплекса России , а также работаем в рамках 275 ФЗ с открытием отдельных счетов в уполномоченном банке. Система менеджмента качества компании соответствует требованиям ГОСТ ISO 9001.

Минимальные сроки поставки, гибкие цены, неограниченный ассортимент и индивидуальный подход к клиентам являются основой для выстраивания долгосрочного и эффективного сотрудничества с предприятиями радиоэлектронной промышленности, предприятиями ВПК и научно-исследовательскими институтами России.

С нами вы становитесь еще успешнее!

Наши контакты:

Телефон: +7 812 627 14 35

Электронная почта: sales@st-electron.ru

Адрес: 198099, Санкт-Петербург,
Промышленная ул, дом № 19, литера Н,
помещение 100-Н Офис 331