



SILICON RFIC LOW CURRENT AMPLIFIER FOR MOBILE COMMUNICATIONS

UPC8179TB

FEATURES

- **HIGH DENSITY SURFACE MOUNTING:**
6 Pin Super Minimold Package (2.0 x 1.25 x 0.9 mm)
- **SUPPLY VOLTAGE:**
V_{CC} = 2.4 to 3.3 V
- **HIGH EFFICIENCY:**
P_o(1dB) = +3.0 dBm TYP at f = 1.0 GHz
P_o(1dB) = +1.5 dBm TYP at f = 1.9 GHz
P_o(1dB) = +1.0 dBm TYP at f = 2.4 GHz
- **POWER GAIN:**
GP = 13.5 dB TYP at f = 1.0 GHz
GP = 15.5 dB TYP at f = 1.9 GHz
GP = 15.5 dB TYP at f = 2.4 GHz
- **EXCELLENT ISOLATION:**
ISL = 44 dB TYP at f = 1.0 GHz
ISL = 42 dB TYP at f = 1.9 GHz
ISL = 41 dB TYP at f = 2.4 GHz
- **LOW CURRENT CONSUMPTION:**
I_{CC} = 4.0 mA TYP AT V_{CC} = 3.0 V
- **OPERATING FREQUENCY:**
I_{CC} = 4.0 mA TYP AT V_{CC} = 3.0 V
- **LIGHT WEIGHT:**
7 mg (standard Value)

APPLICATION

- Buffer amplifiers for 0.1 to 2.4 GHz mobile communications systems.

ELECTRICAL CHARACTERISTICS,

(Unless otherwise specified, T_A = +25°C, V_{CC} = V_{OUT} = 3.0 V, Z_S = Z_L = 50Ω, at LC matched Frequency)

PART NUMBER PACKAGE OUTLINE			UPC8179TB S06		
SYMBOLS	PARAMETERS AND CONDITIONS	UNITS	MIN	TYP	MAX
I _{CC}	Circuit Current (no input signal)	mA	2.9	4.0	5.4
GP	Power Gain, f = 1.0 GHz, P _{IN} = -30 dBm f = 1.9 GHz, P _{IN} = -30 dBm f = 2.4 GHz, P _{IN} = -30 dBm	dB	11.0 13.0 13.0	13.5 15.5 15.5	15.5 17.5 17.5
ISOL	Isolation, f = 1.0 GHz, P _{IN} = -30 dBm f = 1.9 GHz, P _{IN} = -30 dBm f = 2.4 GHz, P _{IN} = -30 dBm	dB	39.0 37.0 36.0	44.0 42.0 41.0	– – –
P _{1dB}	Output Power at 1 dB gain compression, f = 1.0 GHz f = 1.9 GHz f = 2.4 GHz	dB	-0.5 -2.0 -3.0	3.0 1.5 1.0	– – –
NF	Noise Figure, f = 1.0 GHz f = 1.9 GHz f = 2.4 GHz	dB	– – –	5.0 5.0 5.0	6.5 6.5 6.5
RL _{IN}	Input Return Loss, (without matching circuit) f = 1.0 GHz, P _{IN} = -30 dBm f = 1.9 GHz, P _{IN} = -30 dBm f = 2.4 GHz, P _{IN} = -30 dBm	dB	4.0 4.0 6.0	7.0 7.0 9.0	– – –

POWER GAIN vs. FREQUENCY

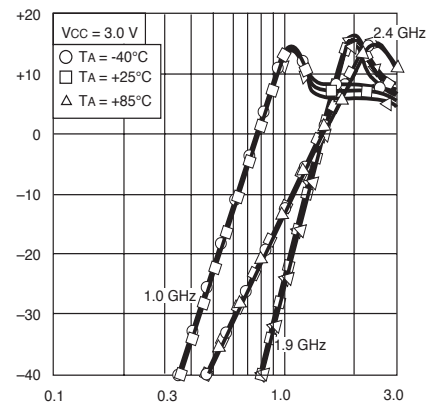

Output match for best performance at each frequency

DESCRIPTION

NEC's UPC8179TB is a silicon monolithic integrated circuit designed as amplifier for mobile communications. This IC can realize low current consumption with external chip inductor which can be realized on internal 50Ω wideband matched IC. This low current amplifier uns on 3.0 V. This IC is manufactured using NEC's 30 GHz fMAX UHS0 (Ultra High Speed Process) silicon bipolar process. This process uses direct silicon nitride passivation film and gold electrodes. These materials can protect the chip surface from pollution and prevent corrosion/migration. Thus this IC has excellent performance uniformity and reliability.

ABSOLUTE MAXIMUM RATINGS¹ (TA = 25°C)

SYMBOLS	PARAMETERS	UNITS	RATINGS
Vcc	Supply Voltage, Pins 4 & 6	V	3.6
Icc	Circuit Current	mA	15
Pd	Power Dissipation ²	mW	270
TOP	Operating Temperature	°C	-40 to +85
TSTG	Storage Temperature	°C	-55 to +150
PIN	Input Power	dBm	+5

Notes:

1. Operation in excess of any one of these parameters may result in permanent damage.
2. Mounted on a 50 x 50 x 1.6 mm epoxy glass PWB (TA = +85°C).

RECOMMENDED OPERATING CONDITIONS

SYMBOLS	PARAMETERS	UNITS	MIN	TYP	MAX
Vcc	Supply Voltage	V	2.7	3.0	3.3
TA	Operating Ambient Temperature	°C	-40	+25	+85

PIN FUNCTIONS

Pin No.	Symbol	Pin Voltage	Description	Internal Equivalent Circuit
1	INPUT	1.09 V	Signal Input Pin. A internal matching circuit, configured with resistors, enable 50 W connection over a wide band. This pin must be coupled to signal source with capacitor for DC cut.	
2 3 5	GND	through external inductor	Ground pin. This pin should be connected to the system ground with minimum inductance. Ground pattern on the board should be formed as wide as possible. All the ground pins must be connected together with wide ground pattern to decrease impedance difference.	
4	OUTPUT	Same as Vcc voltage	Signal output pin. This pin is designed as collector output. Due to the high impedance output, this pin should be externally equipped with matching LC matching circuit to next stage. For L, a size 1005 chip inductor can be chosen.	
6	Vcc	2.4 to 3.3	Power supply pin. This pin should be externally equipped with bypass capacitor to minimize its impedance.	

TYPICAL PERFORMANCE CURVES (Unless otherwise specified, TA = 25°C)

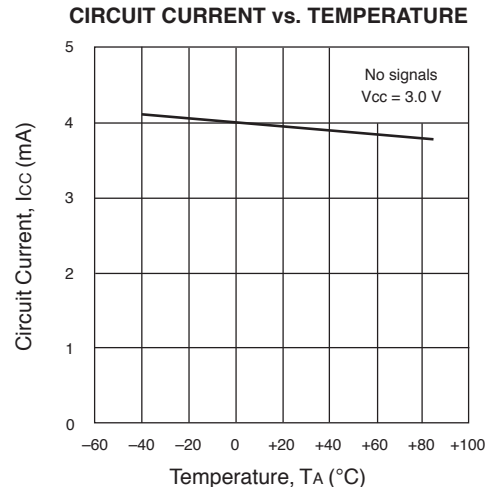
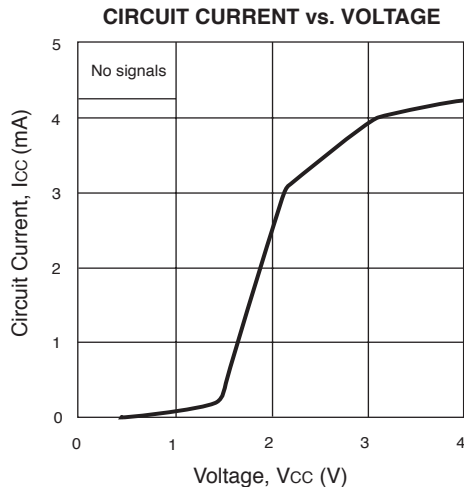

TYPICAL PERFORMANCE CURVES (Unless otherwise specified, $T_A = 25^\circ\text{C}$)

1.0 GHz Output Port Matching

GAIN vs. FREQUENCY

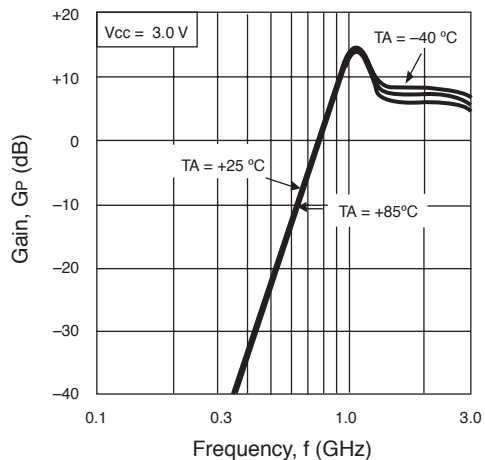

ISOLATION vs. FREQUENCY

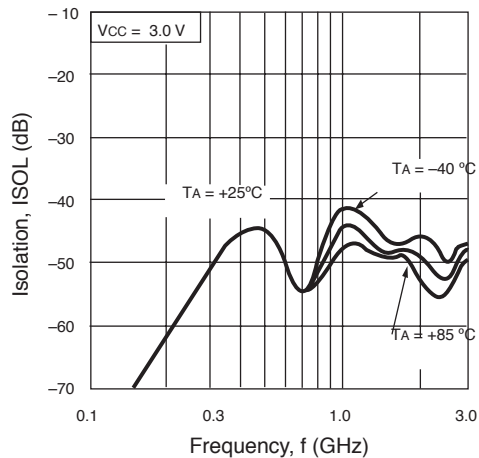

INPUT RETURN LOSS vs. FREQUENCY

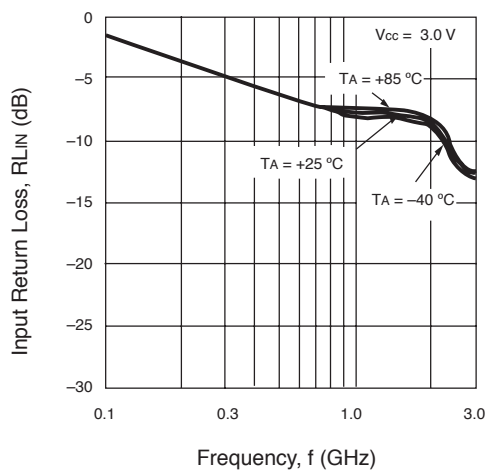

OUTPUT RETURN LOSS vs. FREQUENCY

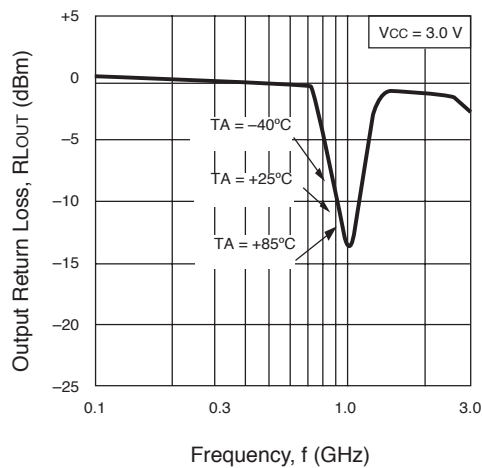

OUTPUT POWER vs. INPUT POWER

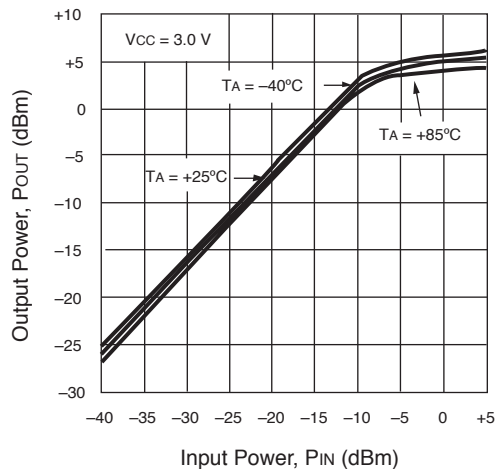

THIRD ORDER INTERMODULATION DISTORTION vs. OUTPUT POWER OF EACH TONE

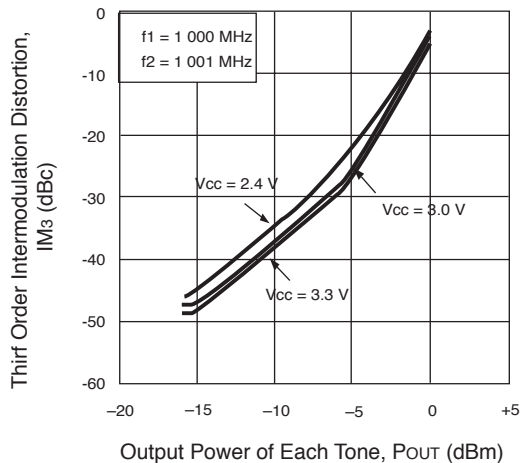

TYPICAL PERFORMANCE CURVES (Unless otherwise specified, $T_A = 25^\circ\text{C}$)

1.0 GHz Output Port Matching

NOISE FIGURE vs. VOLTAGE

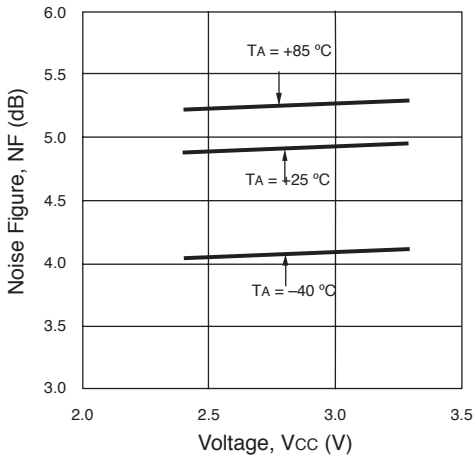

1.9 GHz Output Port Matching

GAIN vs. FREQUENCY

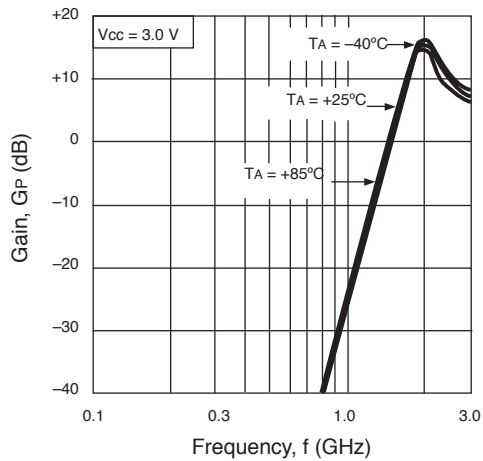

ISOLATION vs. FREQUENCY

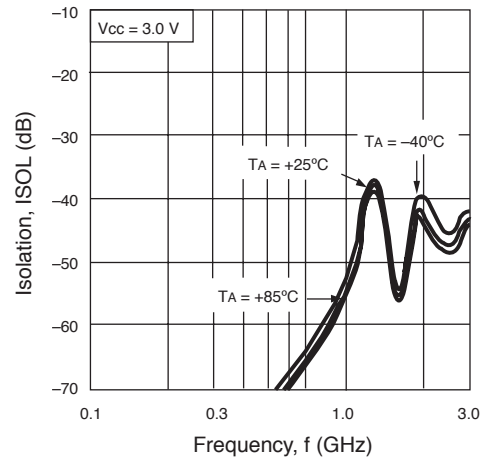

INPUT RETURN LOSS vs. FREQUENCY

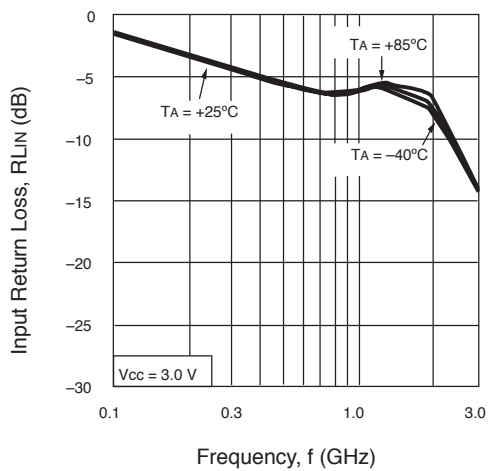

OUTPUT RETURN LOSS vs. FREQUENCY

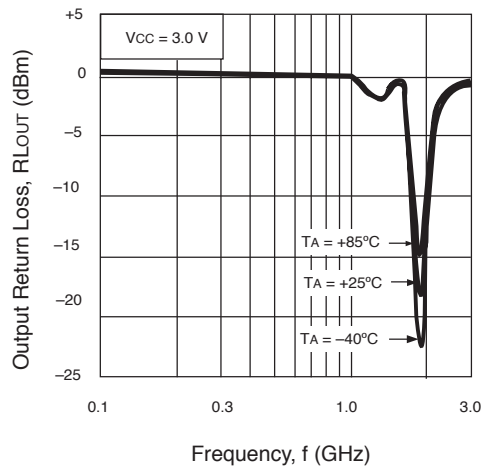

TYPICAL PERFORMANCE CURVES (Unless otherwise specified, $T_A = 25^\circ\text{C}$)

1.9 GHz Output Port Matching

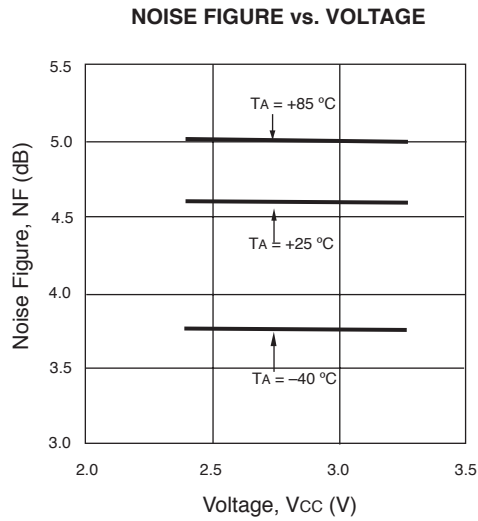
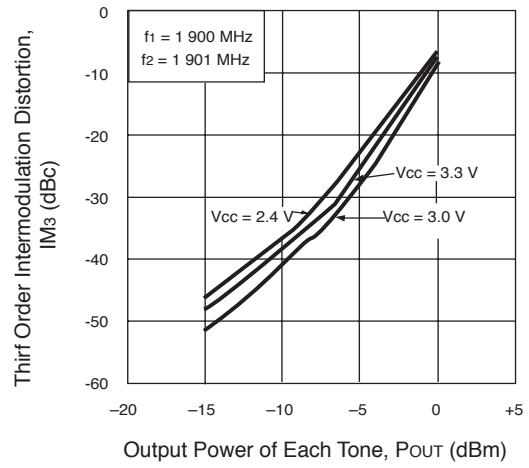
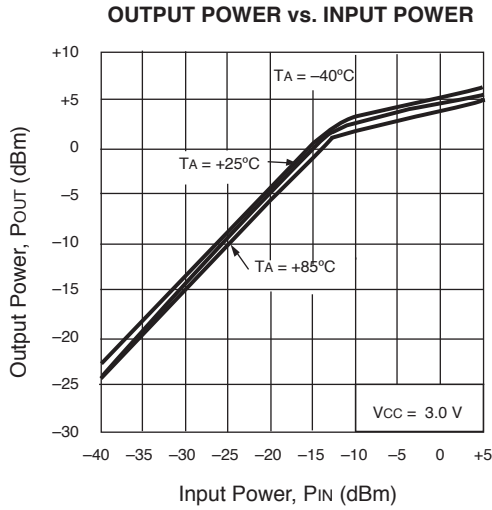

2.4 GHz Output Port Matching

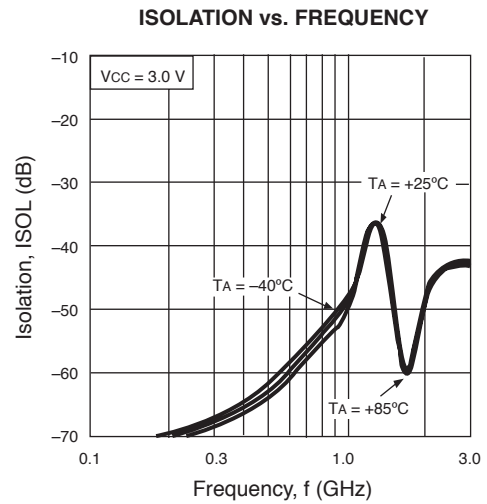
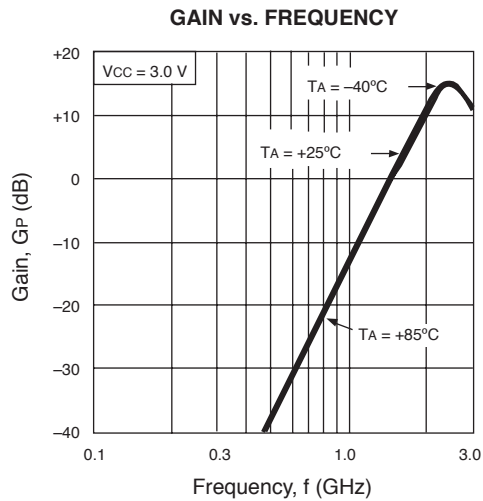

TYPICAL PERFORMANCE CURVES (Unless otherwise specified, $T_A = 25^\circ\text{C}$)

2.4 GHz Output Port Matching

INPUT RETURN LOSS vs. FREQUENCY

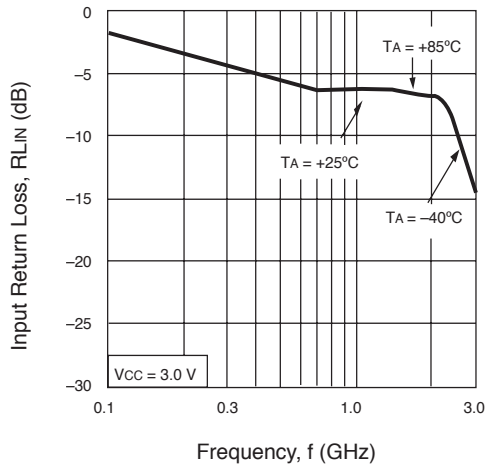

OUTPUT RETURN LOSS vs. FREQUENCY

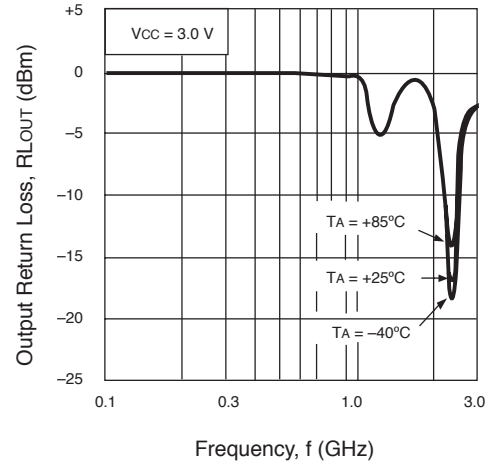

OUTPUT POWER vs. INPUT POWER

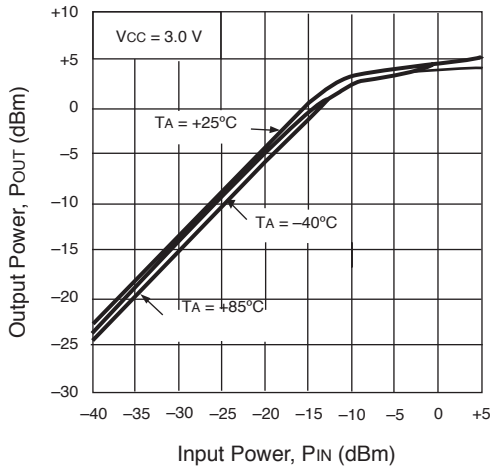

THIRD ORDER INTERMODULATION DISTORTION vs. OUTPUT POWER OF EACH TONE

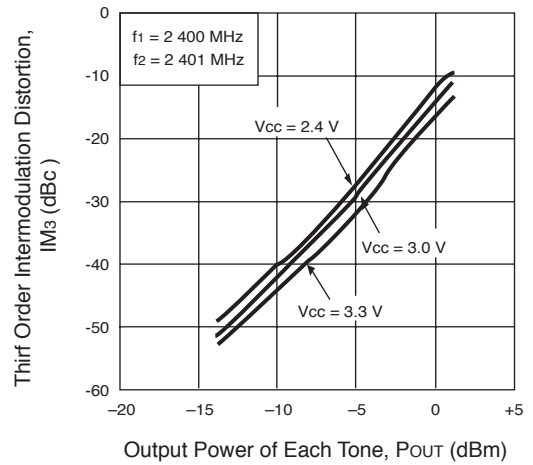

NOISE FIGURE vs. VOLTAGE

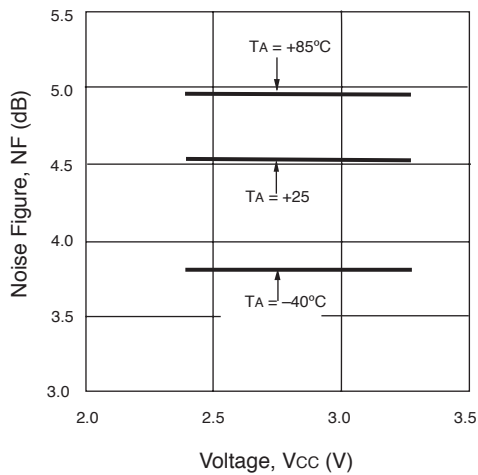

TYPICAL SCATTERING PARAMETERS (TA = 25°C)

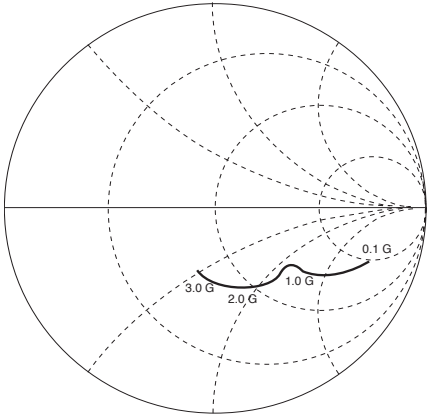

S11

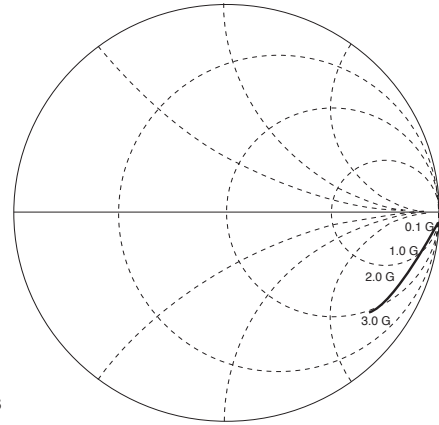

S22

Coordinates in Ohms
Frequency in GHz
 Vcc = Vout = 3.0 V, Icc = 4.0 mA

Vcc = Vout = 3.0 V, Icc = 4.0 mA

FREQUENCY GHz	S11		S21		S12		S22	
	MAG	ANG	MAG	ANG	MAG	ANG	MAG	ANG
0.1	0.824	-17.1	1.181	-177.7	0.002	108.8	0.996	-2.4
0.2	0.692	-25.9	1.181	-172.4	0.003	64.7	0.986	-4.0
0.3	0.594	-29.2	1.247	-167.4	0.004	51.3	0.980	-5.8
0.4	0.533	-30.7	1.370	-164.1	0.005	55.8	0.965	-7.5
0.5	0.499	-31.1	1.514	-162.4	0.005	60.6	0.958	-8.6
0.6	0.474	-32.0	1.677	-162.9	0.006	46.6	0.950	-10.1
0.7	0.460	-32.7	1.885	-163.8	0.006	42.9	0.941	-11.2
0.8	0.450	-34.0	2.050	-166.3	0.006	45.9	0.935	-12.4
0.9	0.441	-35.6	2.237	-169.2	0.005	42.1	0.929	-13.8
1.0	0.438	-37.7	2.460	-173.1	0.007	34.0	0.918	-14.9
1.1	0.431	-39.8	2.627	-177.3	0.007	46.9	0.914	-16.0
1.2	0.426	-42.0	2.772	178.4	0.005	27.7	0.903	-17.0
1.3	0.427	-44.8	2.965	173.2	0.005	40.2	0.895	-18.3
1.4	0.417	-48.1	3.123	168.0	0.004	24.4	0.891	-19.5
1.5	0.413	-50.6	3.199	161.8	0.006	45.5	0.884	-20.4
1.6	0.408	-54.6	3.351	156.8	0.005	44.6	0.877	-21.1
1.7	0.398	-57.6	3.345	151.2	0.003	42.4	0.867	-22.1
1.8	0.387	-61.6	3.103	145.5	0.005	44.6	0.877	-21.1
1.9	0.380	-64.9	3.361	140.9	0.005	59.5	0.859	-24.4
2.0	0.366	-69.1	3.375	136.3	0.004	45.4	0.852	-25.1
2.1	0.352	-72.1	3.350	132.3	0.003	58.3	0.846	-25.9
2.2	0.341	-75.6	3.304	127.9	0.003	73.9	0.847	-26.4
2.3	0.330	-79.4	3.347	124.8	0.006	81.1	0.839	-27.4
2.4	0.320	-82.4	3.325	121.2	0.006	98.3	0.839	-28.2
2.5	0.304	-85.6	3.275	117.3	0.006	100.5	0.838	-29.1
2.6	0.296	-88.2	3.284	113.7	0.004	114.6	0.834	-29.7
2.7	0.285	-91.7	3.283	111.0	0.005	104.8	0.830	-30.6
2.8	0.272	-94.3	3.224	106.5	0.005	114.1	0.831	-31.4
2.9	0.267	-96.9	3.333	104.3	0.008	127.8	0.837	-32.0
3.0	0.256	-99.5	3.251	101.1	0.009	126.3	0.831	-33.4
3.1	0.248	-101.9	3.381	96.0	0.008	134.1	0.833	-34.0

ILLUSTRATION OF THE TEST CIRCUIT ASSEMBLED ON EVALUATION BOARD

COMPONENT LIST

1.0 GHz Output Port Matching	
C1	1000 pF
C2	0.75 pF
C3	10 pF
L1	12 nH

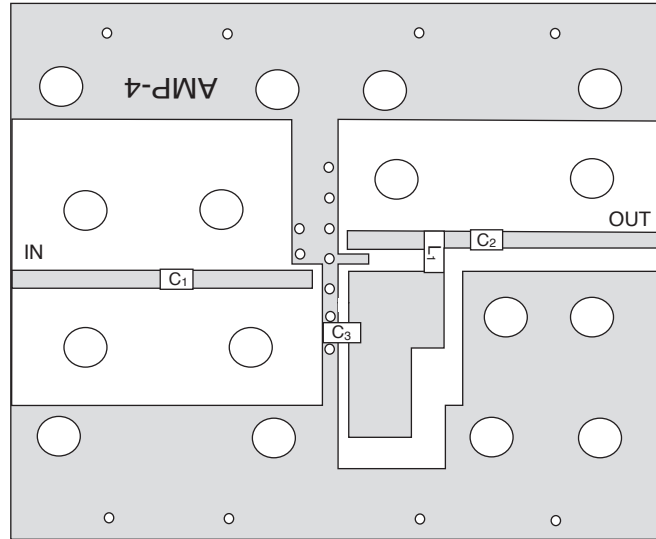
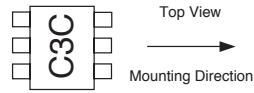

COMPONENT LIST

1.9GHz Output Port Matching	
C1, C3, C5, C6	1000 pF
C2	0.75 pF
C4	10 pF
L1	3.3 nH

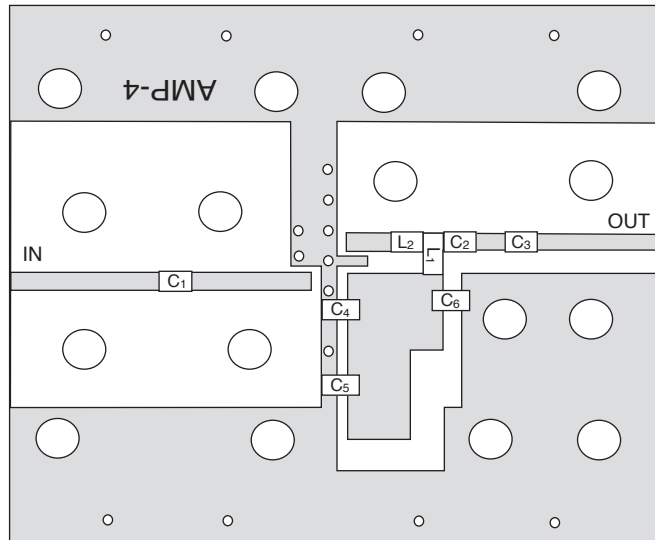

COMPONENT LIST

2.4 GHz Output Port Matching	
C1, C2, C4, C5	1000 pF
C3	10 pF
L1	1.8 nH
L2	2.7 nH

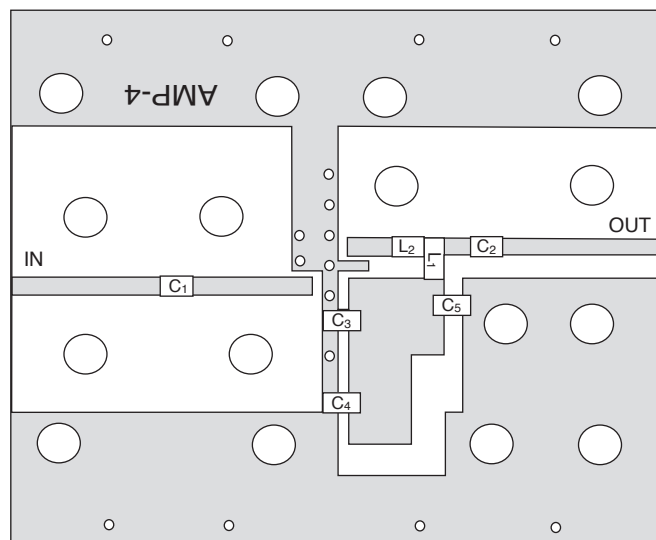

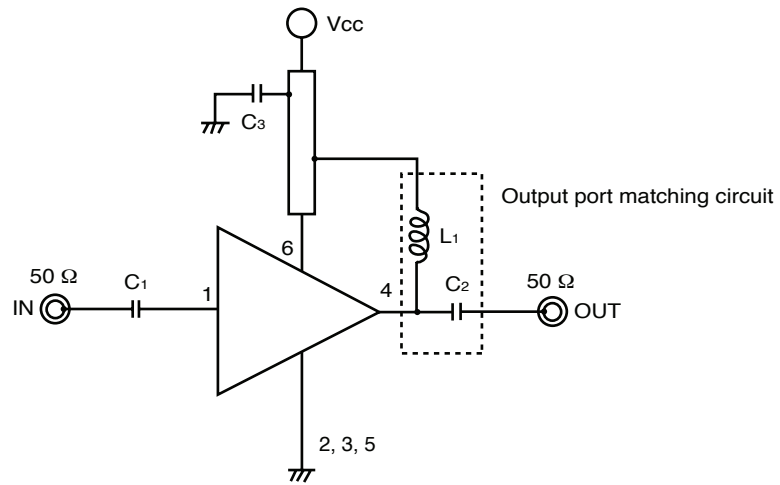
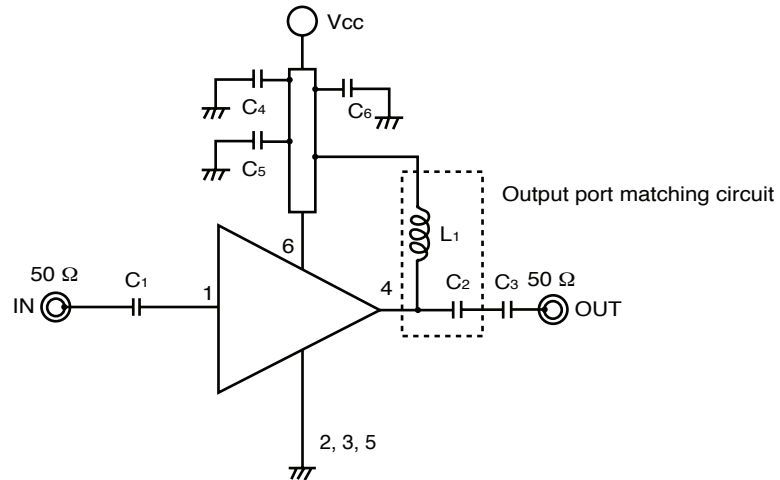
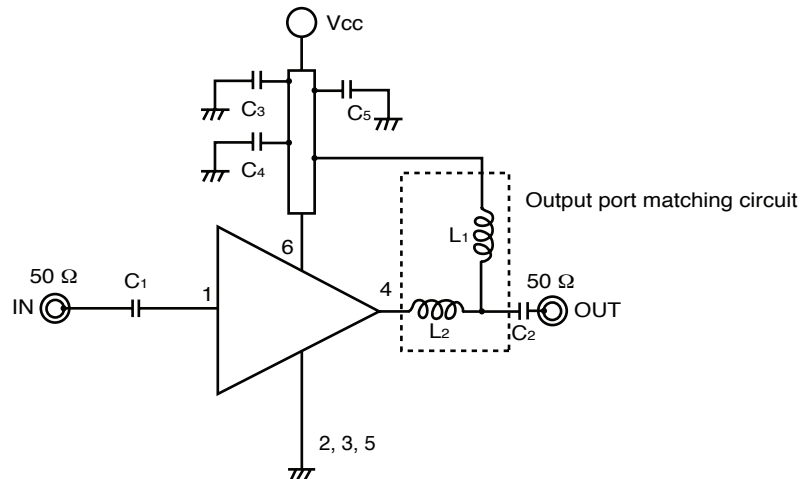
TEST CIRCUITS<1> $f = 1.0 \text{ GHz}$ <2> $f = 1.9 \text{ GHz}$ <3> $f = 2.4 \text{ GHz}$ 

SYSTEM APPLICATION EXAMPLE

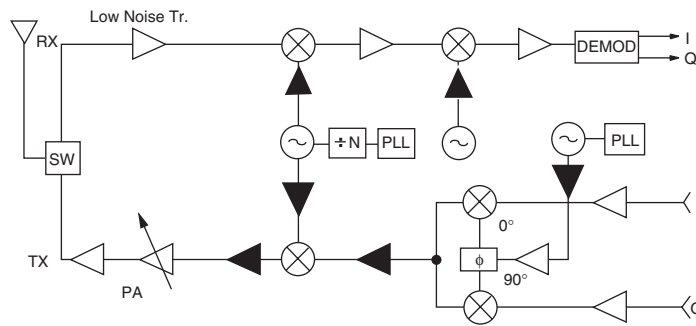

OUTLINE DIMENSIONS (Units in mm)

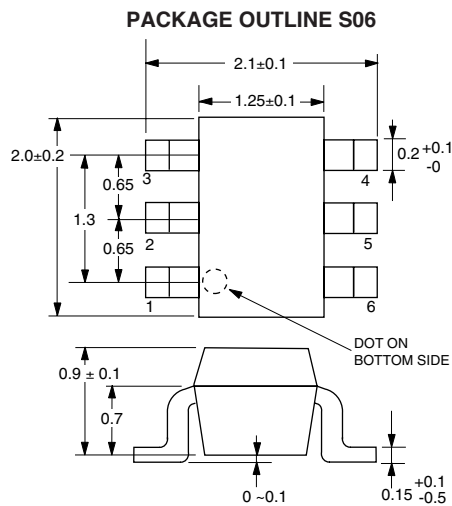

LEAD CONNECTIONS

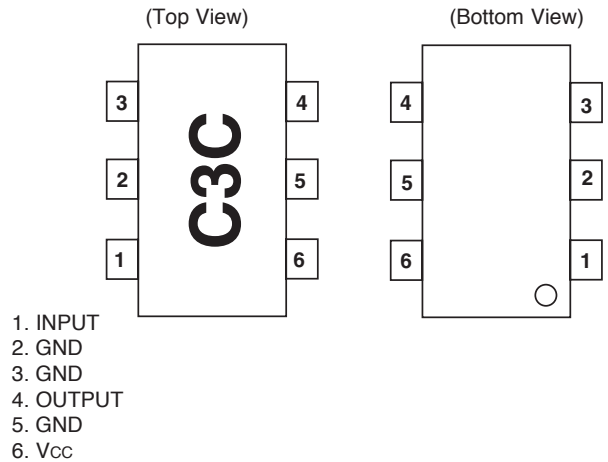

RECOMMENDED P.C.B. LAYOUT (Units in mm)

Note:
All dimensions are typical unless otherwise specified.

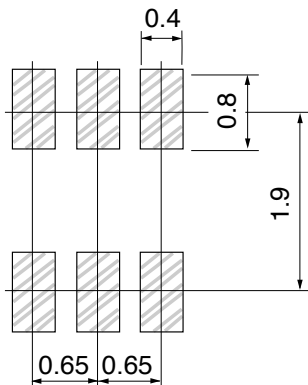

ORDERING INFORMATION

PART NUMBER	QTY
UPC8179TB-E3-A	3K/Reel

Note:
Embossed tape, 8 mm wide. Pins 1, 2, 3 are in tape pull-out direction.

Life Support Applications

These NEC products are not intended for use in life support devices, appliances, or systems where the malfunction of these products can reasonably be expected to result in personal injury. The customers of CEL using or selling these products for use in such applications do so at their own risk and agree to fully indemnify CEL for all damages resulting from such improper use or sale.

EXCLUSIVE NORTH AMERICAN AGENT FOR NEC RF, MICROWAVE & OPTOELECTRONIC SEMICONDUCTORS

CEL CALIFORNIA EASTERN LABORATORIES • Headquarters • 4590 Patrick Henry Drive • Santa Clara, CA 95054-1817 • (408) 919-2500 • Telex 34-6393 • FAX (408) 988-0279
DATA SUBJECT TO CHANGE WITHOUT NOTICE

Internet: <http://WWW.CEL.COM>

05/03/2006

Subject: Compliance with EU Directives

CEL certifies, to its knowledge, that semiconductor and laser products detailed below are compliant with the requirements of European Union (EU) Directive 2002/95/EC Restriction on Use of Hazardous Substances in electrical and electronic equipment (RoHS) and the requirements of EU Directive 2003/11/EC Restriction on Penta and Octa BDE.

CEL Pb-free products have the same base part number with a suffix added. The suffix –A indicates that the device is Pb-free. The –AZ suffix is used to designate devices containing Pb which are exempted from the requirement of RoHS directive (*). In all cases the devices have Pb-free terminals. All devices with these suffixes meet the requirements of the RoHS directive.

This status is based on CEL’s understanding of the EU Directives and knowledge of the materials that go into its products as of the date of disclosure of this information.

Restricted Substance per RoHS	Concentration Limit per RoHS (values are not yet fixed)	Concentration contained in CEL devices	
		-A	-AZ
Lead (Pb)	< 1000 PPM	Not Detected	(*)
Mercury	< 1000 PPM	Not Detected	
Cadmium	< 100 PPM	Not Detected	
Hexavalent Chromium	< 1000 PPM	Not Detected	
PBB	< 1000 PPM	Not Detected	
PBDE	< 1000 PPM	Not Detected	

If you should have any additional questions regarding our devices and compliance to environmental standards, please do not hesitate to contact your local representative.

Important Information and Disclaimer: Information provided by CEL on its website or in other communications concerning the substance content of its products represents knowledge and belief as of the date that it is provided. CEL bases its knowledge and belief on information provided by third parties and makes no representation or warranty as to the accuracy of such information. Efforts are underway to better integrate information from third parties. CEL has taken and continues to take reasonable steps to provide representative and accurate information but may not have conducted destructive testing or chemical analysis on incoming materials and chemicals. CEL and CEL suppliers consider certain information to be proprietary, and thus CAS numbers and other limited information may not be available for release.

In no event shall CEL’s liability arising out of such information exceed the total purchase price of the CEL part(s) at issue sold by CEL to customer on an annual basis.

See CEL Terms and Conditions for additional clarification of warranties and liability.



Стандарт Электрон Связь

Мы молодая и активно развивающаяся компания в области поставок электронных компонентов. Мы поставляем электронные компоненты отечественного и импортного производства напрямую от производителей и с крупнейших складов мира.

Благодаря сотрудничеству с мировыми поставщиками мы осуществляем комплексные и плановые поставки широчайшего спектра электронных компонентов.

Собственная эффективная логистика и склад в обеспечивает надежную поставку продукции в точно указанные сроки по всей России.

Мы осуществляем техническую поддержку нашим клиентам и предпродажную проверку качества продукции. На все поставляемые продукты мы предоставляем гарантию .

Осуществляем поставки продукции под контролем ВП МО РФ на предприятия военно-промышленного комплекса России , а также работаем в рамках 275 ФЗ с открытием отдельных счетов в уполномоченном банке. Система менеджмента качества компании соответствует требованиям ГОСТ ISO 9001.

Минимальные сроки поставки, гибкие цены, неограниченный ассортимент и индивидуальный подход к клиентам являются основой для выстраивания долгосрочного и эффективного сотрудничества с предприятиями радиоэлектронной промышленности, предприятиями ВПК и научно-исследовательскими институтами России.

С нами вы становитесь еще успешнее!

Наши контакты:

Телефон: +7 812 627 14 35

Электронная почта: sales@st-electron.ru

Адрес: 198099, Санкт-Петербург,
Промышленная ул, дом № 19, литера Н,
помещение 100-Н Офис 331