

# E3C

**Thin, Compact Head Saves Space and Mounts Closely. Built-in Interference Protection Provided.**

- Input indicator on the Sensor Unit simplifies settings.























 Be sure to read *Safety Precautions* on page 11.

## Ordering Information

### Sensors

**Sensor Units** [Refer to *Dimensions* on page 12.]

 Red light  Infrared light

Sensing method	Application	Appearance	Sensing distance	Model	
Through-beam (Emitter + Receiver) *	Small type		 100 mm	<b>E3C-S10 2M</b> Emitter E3C-S10L 2M Receiver E3C-S10D 2M	
			 500 mm	<b>E3C-S50 2M</b> Emitter E3C-S50L 2M Receiver E3C-S50D 2M	
			 1 m	<b>E3C-1 2M</b> Emitter E3C-1L 2M Receiver E3C-1D 2M	
			 2 m	<b>E3C-2 2M</b> Emitter E3C-2L 2M Receiver E3C-2D 2M	
			 200 mm	<b>E3C-S20W 2M</b> Emitter E3C-S20LW 2M Receiver E3C-S20DW 2M	
			 300 mm	<b>E3C-S30W 2M</b> Emitter E3C-S30LW 2M Receiver E3C-S30DW 2M	
	Side-view			<b>E3C-S30T 2M</b> Emitter E3C-S30LT 2M Receiver E3C-S30DT 2M	
	Diffuse-reflective	Small type		 100 mm	<b>E3C-DS10 2M</b>
		Slim type		 50 mm	<b>E3C-DS5W 2M</b>
		Side-view		 100 mm	<b>E3C-DS10T 2M</b>
Convergent-reflective	Small type		 30±3 mm	<b>E3C-LS3R 2M</b>	

\* Through-beam Sensors are normally sold in sets that include both the Emitter and Receiver. Orders for individual Emitters and Receivers are accepted. (Modifications are required for some models. Ask your OMRON representative for details.)

**Amplifier Units** [Refer to *Amplifier Units* on page 15.]

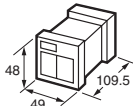
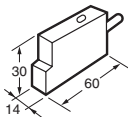
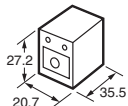
Power supply	Application	Appearance	Functions	Model
AC	Standard models		---	E3C-A
			Timer	E3C-C
DC	Slim type		Self diagnostic	E3C-JC4P 2M
	Small type		---	E3C-GE4

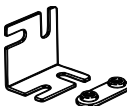
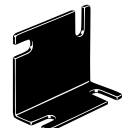
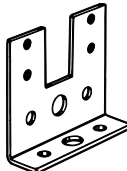
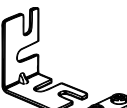

**Accessories (Order Separately)**
**Mounting Brackets** [Refer to *E39-L/F39-L/E39-S/E39-R* for Dimensions.]

Appearance	Model	Quantity	Remarks
	E39-L41	2	Provided with the E3C-1.
	E39-L42	2	Provided with the E3C-2. Can be used with the E3C-DS10.
	E39-L127-T1	1	Can be used with the E3C-S10.
	E39-L127-T2	1	
	E39-L127-T3	1	
	E39-L31	1*	Can be used with the E3C-S50.

Note: Refer to *E39-L/F39-F/E39-S/E39-R* for Dimensions.

\* When using through-beam models, order one bracket for the Receiver and one for the Emitter.

**Connector** [Refer to *E39-L/F39-L/E39-S/E39-R* for Dimensions.]

Name	Appearance	Model	Quantity	Remarks
Front connection socket		PF113A	1	Provided with the E3C-A/C.
		PYF08A	1	Can be used with the E3C-GE4.
Rear connection socket		PY08	1	Can be used with the E3C-GE4.

## Ratings and Specifications

### Sensors

Sensing method		Through-beam					
Item	Model	E3C-S10	E3C-S20W	E3C-S50	E3C-S30T E3C-S30W	E3C-1	E3C-2
Sensing distance		100 mm	200 mm	500 mm	300 mm	1 m	2 m
Standard sensing object		Opaque, 2-mm dia. min.		Opaque, 3-mm dia. min.	Opaque, 1.5-mm dia. min.	Opaque, 4-mm dia. min.	Opaque, 8-mm dia. min.
Directional angle		Emitter/Receiver: 10 to 60° each		Emitter/Receiver: 10 to 40° each		Emitter/Receiver: 3 to 20° each	Emitter/Receiver: 3 to 15° each
Light source (wavelength)		Infrared LED (950 nm)			Infrared LED (940 nm)	Infrared LED (950 nm)	
Ambient illuminance (Receiver side)		Incandescent lamp: 3,000 lx max., Sunlight 10,000 lx max.					
Ambient temperature range		Operating/Storage: -25°C to 70°C (with no icing or condensation)					
Ambient humidity range		Operating: 35% to 85%, Storage: 35% to 95% (with no condensation)					
Insulation resistance		20 MΩ min. at 500 VDC					
Dielectric strength		500 VAC at 50/60 Hz for 1 minute					
Vibration resistance		Destruction: 10 to 55 Hz, 1.5-mm double amplitude for 2 hours each in X, Y, and Z directions					
Shock resistance		Destruction: 500 m/s <sup>2</sup> for 3 times each in X, Y, and Z directions					
Degree of protection		IEC 60529 IP64 Limited to indoor use	IEC 60529 IP50 Limited to indoor use	IEC 60529 IP64 Limited to indoor use	IEC 60529 IP60 Limited to indoor use	IEC 60529 IP66 Limited to indoor use	
Connection method		Pre-wired models (standard length: 2 m)					
Weight (packed state)		Approx. 50 g			Approx. 24 g	Approx. 60 g	Approx. 120 g
Material	Case	Polycarbonate		ABS	Polycarbonate		Zinc die-cast
	Lens	Polycarbonate		Acrylics	Polycarbonate		
	Mounting Brackets	---				Steel	
Accessories	Instruction manual	Phillips screw M2×8, spring washer, flat washer, M2 nut, instruction manual	Instruction manual	Phillips screw M2×8, spring washer, flat washer, nut M2, instruction manual	Mounting Bracket (with screws), instruction manual	Mounting Bracket (with screws), instruction manual	

Sensing method		Diffuse-reflective			Convergent-reflective	
Item	Model	E3C-DS5W	E3C-DS10T	E3C-DS10	E3C-LS3R	
Sensing distance		50 mm (White paper 100 × 100 mm)	100 mm (White paper 100 × 100 mm)	100 mm (White paper 50 × 50 mm)	30 ± 3 mm (White paper 10 × 10 mm)	
Differential travel		20% max. of sensing distance			10% max.	±3% max.
Light source (wavelength)		Infrared LED (950 nm)	Infrared LED (950 nm)		Red LED (680 nm)	
Ambient illuminance (Receiver side)		Incandescent lamp: 3,000 lx max., Sunlight 10,000 lx max.				
Ambient temperature range		Operating/Storage: -25°C to 70°C (with no icing or condensation)				
Ambient humidity range		Operating: 35% to 85%, Storage: 35% to 95% (with no condensation)				
Insulation resistance		20 MΩ min. at 500 VDC				
Dielectric strength		500 VAC at 50/60 Hz for 1 minute				
Vibration resistance		Destruction: 10 to 55 Hz, 1.5-mm double amplitude for 2 hours each in X, Y, and Z directions				
Shock resistance		Destruction: 500 m/s <sup>2</sup> for 3 times each in X, Y, and Z directions				
Degree of protection		IEC 60529 IP50 (Limited to indoor use)			IEC 60529 IP64 (Limited to indoor use)	
Connection method		Pre-wired models (standard length: 2 m)				
Weight (packed state)		Approx. 50 g			Approx. 55 g	
Material	Case	Polycarbonate				
	Lens	Polycarbonate				
Accessories		Phillips screw M2×8, spring washer, flat washer, M2 nut, instruction manual	Instruction manual			

## Amplifier Units

Item	Model	E3C-A	E3C-C	E3C-JC4P	E3C-GE4
Power supply voltage		100 to 240 VAC±10%, 50/60 Hz		12 to 24 VDC±10%, ripple (p-p): 1 V max.	
Power (current) consumption		3 W max.		50 mA max.	
Control output	Transistor output	Load power supply voltage: 24 VDC max., load current: 80 mA max., voltage output type, output current: 1 to 4 mA (residual voltage: 1.2 V max.) Light-ON/Dark-ON switch selectable		Load power supply voltage: 24 VDC max., load current: 100 mA max., NPN open collector output type (residual voltage: 1 V max.) Light-ON/Dark-ON switch selectable	Load power supply voltage: 24 VDC max., load current: 80 mA max., voltage output type, output current: 1 to 4 mA (residual voltage: 0.7 V max.) Light-ON/Dark-ON cable connection selectable
	Relay output	220 VAC 1 A cosφ=1 (resistive load) SPDT contact only		---	
External synchronous input		---	H = 6 to 30 V L = 0 to 2 V When L, turns OFF the control output forcibly.	---	
Timer function		---	ON/OFF, oneshot delay (selectable): 1 or 10 s max.	OFF-delay 0/40 ms (switch selectable)	---
Ambient temperature range		Operating: -10° to 55°C, Storage: -25° to 70°C (with no icing or condensation)			
Ambient humidity range		Operating: 35% to 85%, Storage: 35% to 95% (with no condensation)			
Insulation resistance		20 MΩ min. at 500 VDC			
Dielectric strength		500 VAC at 50/60 Hz for 1 minute			
Vibration resistance		Destruction: 10 to 55 Hz, 1.5-mm double amplitude for 2 hours each in X, Y, and Z directions			
Shock resistance		Destruction: 300 ms <sup>2</sup> three times in each of X, Y and Z directions			
Degree of protection		IEC IP20 (limited to indoor use)		IEC IP60 (limited to indoor use)	IEC IP20 (limited to indoor use)
Protection		Reverse polarity protection, output short-circuit protection, mutual interference prevention			
Response time	No contact	Operate or reset: 1 ms max./2 ms max. each (switch selectable)		Operate or reset: 1 ms max.	Operate or reset: 1 ms max./2 ms max. each (switch selectable)
	Relay	Operate or reset: 20 ms max.		---	
Connection method		Terminal block		Terminal block input cable pullout (standard cable length: 2 m)	Terminal block
Weight (packed state)		Approx. 200 g		Approx. 80 g	Approx. 15 g
Material	Case	ABS			Polycarbonate
	Mounting Brackets	Stainless steel	---	Iron	---
Accessories		Connection Socket (PF113A) Instruction manual		Mounting Bracket, Adjustment screwdriver, Caution label, Instruction manual	Instruction manual

\* The terminal pins are used for connection between amplifiers for synchronous operation.

# Engineering Data (Typical)

## Parallel Operating Range

### Through-beam

#### E3C-S10

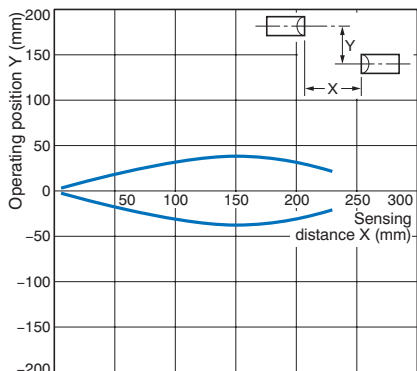

### Through-beam

#### E3C-S20W

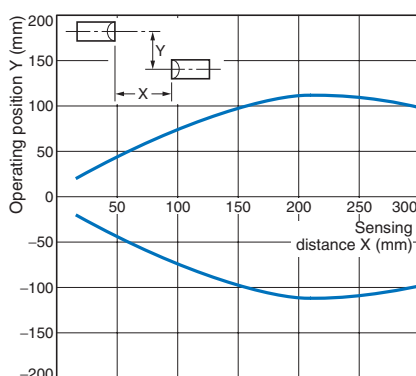

### Through-beam

#### E3C-S50

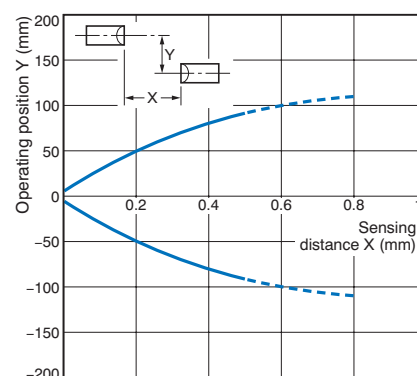

### Through-beam

#### E3C-1

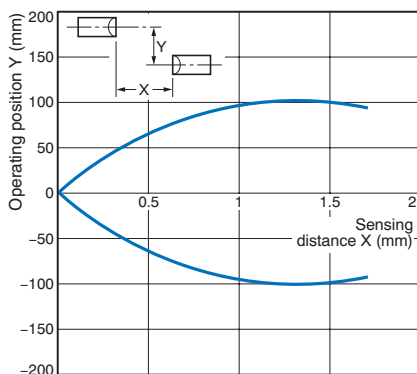

### Through-beam

#### E3C-2

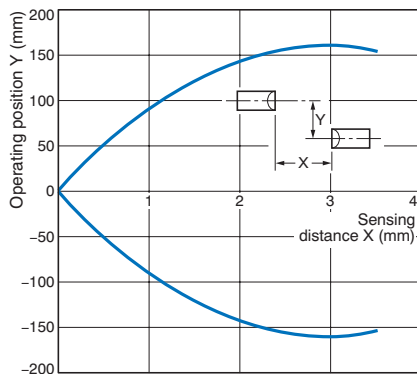

### Through-beam

#### E3C-S30T/-S30W

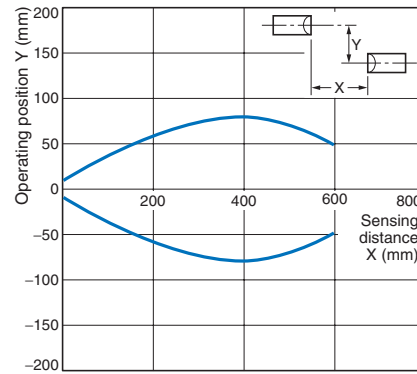

## Operating Range

### Diffuse-reflective

#### E3C-DS5W

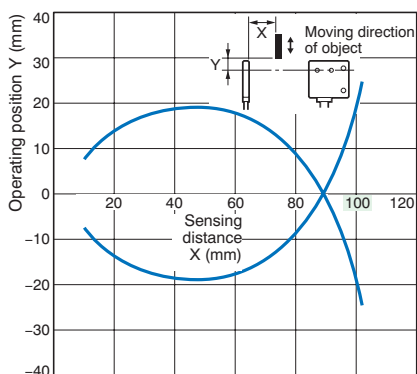

### Diffuse-reflective

#### E3C-DS10T

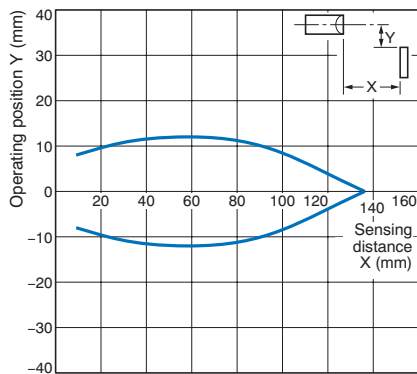

### Diffuse-reflective

#### E3C-DS10 (Example 1)

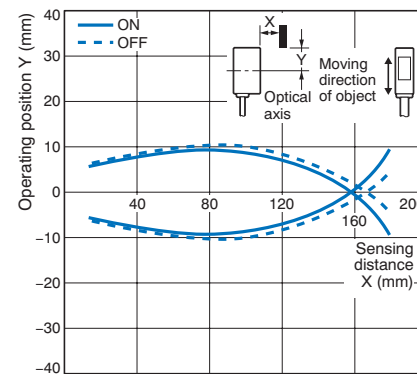

**Diffuse-reflective**  
**E3C-DS10 (Example 2)**

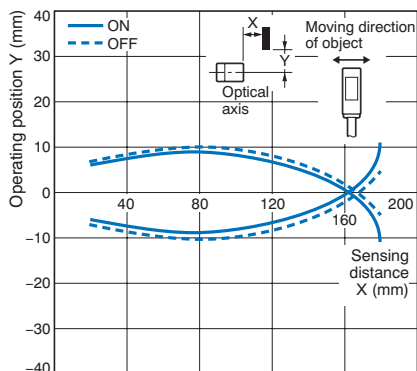

**Convergent-reflective**  
**E3C-LS3R (Example 1)**

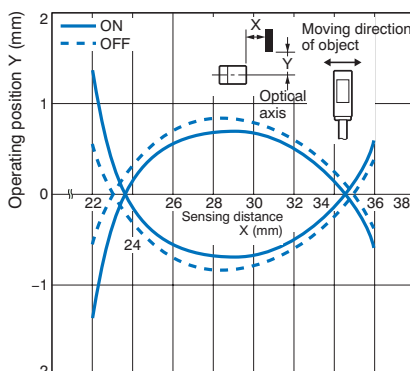

**Convergent-reflective**  
**E3C-LS3R (Example 2)**

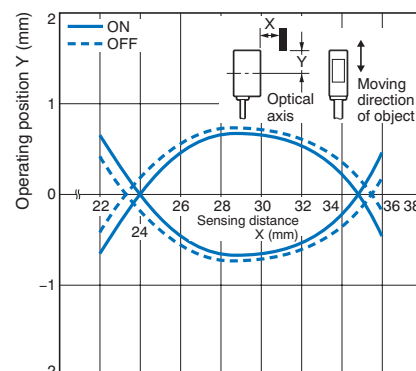

**Excess Gain vs. Set Distance**

**E3C-S20W**

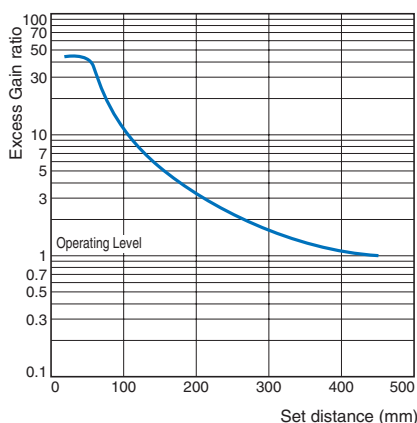

**E3C-S30T/-S30W**

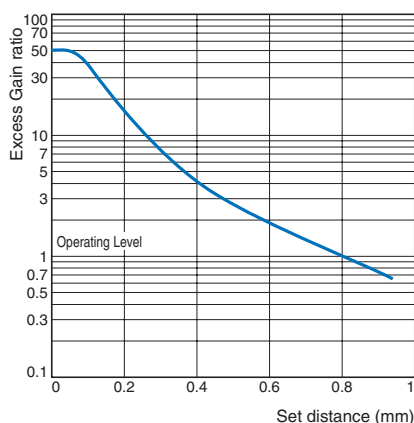

**E3C-S50**

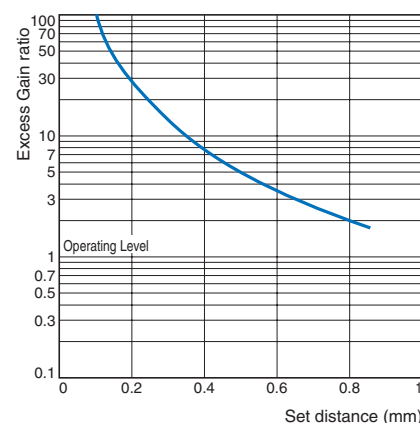

**E3C-DS5W**

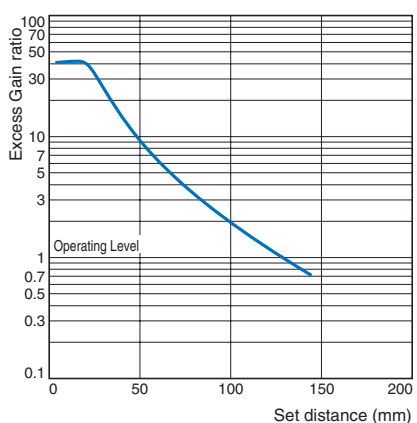

**E3C-DS10T**

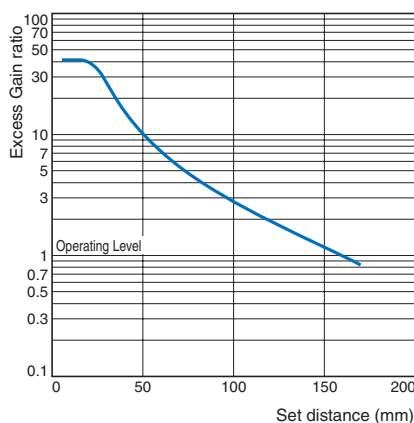

**E3C-LS3R**

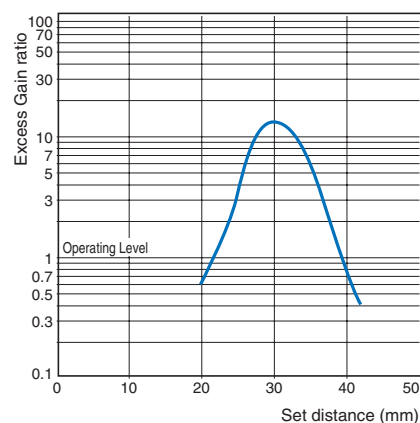

# I/O Circuit Diagrams

## NPN output

Model	Operation mode	Timing charts *	Operation selector	Output circuit
E3C-A E3C-C	Light-ON		LIGHT ON	
	Dark-ON		DARK ON	<p>* 1. E3C-C only * 2. E3C-A/-C have SPDT contact output. (About terminal number, please refer to the connection section.)</p>
E3C-JC4P	Light-ON		L-ON (LIGHT ON)	
	Dark-ON		D-ON (DARK ON)	<p>Brown 12 to 24 VDC Black Load 100 mA max. Blue 0 V Pink Self diagnostic output 50 mA max.</p>
E3C-GE4	Light-ON		Switched with wiring. ⑭ + - ④ (LIGHT ON)	
	Dark-ON		Switched with wiring. ⑭ - + ④ (DARK ON)	<p>Rated current 1.5 to 4 mA 80 mA max.</p>



\* For t in the timing chart, refer to Part Names/Selection Method on page 9.



Connection

Amplifier Units	Connected to the through-beam model	Connected to the reflective model	Note
E3C-A/C + PF113A			<p>Note: 1. The strip-off length of the shielded cable should always be 20 mm max. on the Receiver side (white) and 50 mm max. on the Emitter side (red).                  2. The E3C-A does not have a gate input function.                  3. L when the gate input 2-9 terminals are connected, H when they are disconnected.</p>
E3C-JC4P			<p>Note: 1. The strip-off length of the shielded cable should always be 20 mm max. on the Receiver side (white) and 50 mm max. on the Emitter side (red).</p>
E3C-GE4			<p>Note: 1. The strip-off length of the shielded cable should always be 20 mm max. on the Receiver side (white) and 50 mm max. on the Emitter side (red).                  2. The response time is 1 ms when (8) is disconnected, and 2 ms when (8) is connected to 0 V (negative side) of the power supply.                  3. By setting the power supply terminal (4) to – and (14) to +, the output turns "H" when the light is received. With the E2 mode, the output transistor turns OFF. By setting (4) to + and (14) to +, the output turns "L" when the light is received. With the E1 mode, the output transistor turns ON.</p>

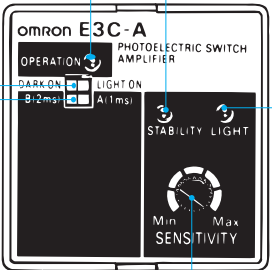
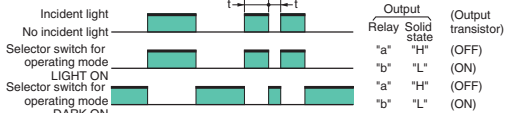
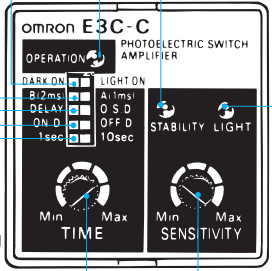

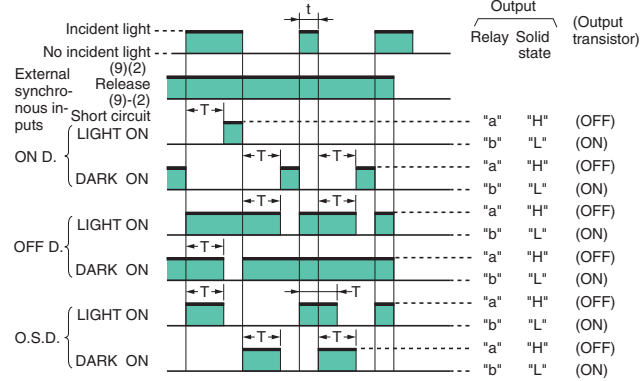
# Nomenclature/Settings

Amplifier Units	Nomenclature	Settings																																					
<p>E3C-A</p>	 <p>Operation indicator (red) When a relay-switch operates, the indicator turns on.</p> <p>Stability indicator (green) When the light receiving input becomes +20% or more and -20% or less of operating voltage, it will be turned on. (Indicate stable status)</p> <p>Operation selector</p> <p>Response time selector switch</p> <p>Sensitivity adjuster</p> <p>Light indicator (red) When the light inputs, it will be turned on.</p>	<p><b>Operation switching</b></p> <table border="1" data-bbox="837 275 1481 376"> <tr> <td>DARK ON <input type="checkbox"/></td> <td>LIGHT ON <input type="checkbox"/></td> <td>DARK turns the relay ON and the transistor output "H".</td> </tr> <tr> <td>DARK ON <input type="checkbox"/></td> <td>LIGHT ON <input type="checkbox"/></td> <td>LIGHT turns the relay ON and the transistor output "H".</td> </tr> </table> <p><b>Response time changing (The different frequency type can be made up by changing the response speed.)</b></p> <table border="1" data-bbox="837 454 1481 544"> <tr> <td>2 ms (B) <input type="checkbox"/></td> <td>1 ms (A) <input type="checkbox"/></td> <td>The response time is set to 2 ms.</td> </tr> <tr> <td>2 ms (B) <input type="checkbox"/></td> <td>1 ms (A) <input type="checkbox"/></td> <td>The response time is set to 1 ms.</td> </tr> </table> <p><b>Timing chart</b></p>  <p>Note 1. Control output is produced only during input time. 2. When t exceeds 1 ms or 2 ms, solid-state output is produced. To produce relay output, t must be longer than 20 ms.</p>	DARK ON <input type="checkbox"/>	LIGHT ON <input type="checkbox"/>	DARK turns the relay ON and the transistor output "H".	DARK ON <input type="checkbox"/>	LIGHT ON <input type="checkbox"/>	LIGHT turns the relay ON and the transistor output "H".	2 ms (B) <input type="checkbox"/>	1 ms (A) <input type="checkbox"/>	The response time is set to 2 ms.	2 ms (B) <input type="checkbox"/>	1 ms (A) <input type="checkbox"/>	The response time is set to 1 ms.																									
	DARK ON <input type="checkbox"/>	LIGHT ON <input type="checkbox"/>	DARK turns the relay ON and the transistor output "H".																																				
DARK ON <input type="checkbox"/>	LIGHT ON <input type="checkbox"/>	LIGHT turns the relay ON and the transistor output "H".																																					
2 ms (B) <input type="checkbox"/>	1 ms (A) <input type="checkbox"/>	The response time is set to 2 ms.																																					
2 ms (B) <input type="checkbox"/>	1 ms (A) <input type="checkbox"/>	The response time is set to 1 ms.																																					
<p>E3C-C</p>	 <p>Operation indicator (red) When a relay-switch operates, the indicator turns on.</p> <p>Stability indicator (green) When the light receiving input becomes +20% or more and -20% or less of operating voltage, it will be turned on. (Indicate stable status)</p> <p>Operation selector</p> <p>Selector switch for response time</p> <p>Timer function setting switch</p> <p>Delay time setting switch</p> <p>Delay time adjuster</p> <p>Sensitivity adjuster</p> <p>Light indicator (red) When the light inputs, it will be turned on.</p>	<p><b>Operation switching</b></p> <table border="1" data-bbox="837 819 1481 920"> <tr> <td>DARK ON <input type="checkbox"/></td> <td>LIGHT ON <input type="checkbox"/></td> <td>DARK turns the relay ON and the transistor output "H".</td> </tr> <tr> <td>DARK ON <input type="checkbox"/></td> <td>LIGHT ON <input type="checkbox"/></td> <td>LIGHT turns the relay ON and the transistor output "H".</td> </tr> </table> <p><b>Response time changing (The different frequency type can be made up by changing the response speed.)</b></p> <table border="1" data-bbox="837 999 1481 1088"> <tr> <td>2 ms (B) <input type="checkbox"/></td> <td>1 ms (A) <input type="checkbox"/></td> <td>The response time is set to 2 ms.</td> </tr> <tr> <td>2 ms (B) <input type="checkbox"/></td> <td>1 ms (A) <input type="checkbox"/></td> <td>The response time is set to 1 ms.</td> </tr> </table> <p><b>Delay time setting</b></p> <table border="1" data-bbox="837 1133 1481 1223"> <tr> <td>1 sec <input type="checkbox"/></td> <td>10 sec <input type="checkbox"/></td> <td>0.1 to 1 s can be set.</td> </tr> <tr> <td>1 sec <input type="checkbox"/></td> <td>10 sec <input type="checkbox"/></td> <td>1 to 10 s can be set.</td> </tr> </table> <p>↓</p>  <p>After setting the selector, fine-adjust the delay time with the variable adjuster. (Clockwise turn increases the delay time.)</p>	DARK ON <input type="checkbox"/>	LIGHT ON <input type="checkbox"/>	DARK turns the relay ON and the transistor output "H".	DARK ON <input type="checkbox"/>	LIGHT ON <input type="checkbox"/>	LIGHT turns the relay ON and the transistor output "H".	2 ms (B) <input type="checkbox"/>	1 ms (A) <input type="checkbox"/>	The response time is set to 2 ms.	2 ms (B) <input type="checkbox"/>	1 ms (A) <input type="checkbox"/>	The response time is set to 1 ms.	1 sec <input type="checkbox"/>	10 sec <input type="checkbox"/>	0.1 to 1 s can be set.	1 sec <input type="checkbox"/>	10 sec <input type="checkbox"/>	1 to 10 s can be set.																			
	DARK ON <input type="checkbox"/>	LIGHT ON <input type="checkbox"/>	DARK turns the relay ON and the transistor output "H".																																				
DARK ON <input type="checkbox"/>	LIGHT ON <input type="checkbox"/>	LIGHT turns the relay ON and the transistor output "H".																																					
2 ms (B) <input type="checkbox"/>	1 ms (A) <input type="checkbox"/>	The response time is set to 2 ms.																																					
2 ms (B) <input type="checkbox"/>	1 ms (A) <input type="checkbox"/>	The response time is set to 1 ms.																																					
1 sec <input type="checkbox"/>	10 sec <input type="checkbox"/>	0.1 to 1 s can be set.																																					
1 sec <input type="checkbox"/>	10 sec <input type="checkbox"/>	1 to 10 s can be set.																																					
<p><b>Timer function setting</b></p> <table border="1" data-bbox="304 1435 804 1966"> <tr> <td rowspan="3"><b>When selecting ON delay (ON D.)</b></td> <td>DARK ON <input type="checkbox"/></td> <td>LIGHT ON <input type="checkbox"/></td> <td>← Set a position freely</td> </tr> <tr> <td>2 ms (B) <input type="checkbox"/></td> <td>1 ms (A) <input type="checkbox"/></td> <td>← Set a position freely</td> </tr> <tr> <td>DELAY <input type="checkbox"/></td> <td>O.S.D. <input type="checkbox"/></td> <td></td> </tr> <tr> <td rowspan="3"><b>When selecting OFF delay (OFF D.)</b></td> <td>ON D. <input type="checkbox"/></td> <td>OFF D. <input type="checkbox"/></td> <td>← Set a position freely</td> </tr> <tr> <td>1 sec <input type="checkbox"/></td> <td>10 sec <input type="checkbox"/></td> <td>← Set a position freely</td> </tr> <tr> <td>DELAY <input type="checkbox"/></td> <td>O.S.D. <input type="checkbox"/></td> <td></td> </tr> <tr> <td rowspan="3"><b>When selecting one-shot delay (O.S.D.)</b></td> <td>DARK ON <input type="checkbox"/></td> <td>LIGHT ON <input type="checkbox"/></td> <td>← Set a position freely</td> </tr> <tr> <td>2 ms (B) <input type="checkbox"/></td> <td>1 ms (A) <input type="checkbox"/></td> <td>← Set a position freely</td> </tr> <tr> <td>DELAY <input type="checkbox"/></td> <td>O.S.D. <input type="checkbox"/></td> <td>Since the function has stopped, it allows in both of the positions.</td> </tr> <tr> <td></td> <td>ON D. <input type="checkbox"/></td> <td>OFF D. <input type="checkbox"/></td> <td>← Set a position freely</td> </tr> <tr> <td></td> <td>1 sec <input type="checkbox"/></td> <td>10 sec <input type="checkbox"/></td> <td></td> </tr> </table>	<b>When selecting ON delay (ON D.)</b>	DARK ON <input type="checkbox"/>	LIGHT ON <input type="checkbox"/>	← Set a position freely	2 ms (B) <input type="checkbox"/>	1 ms (A) <input type="checkbox"/>	← Set a position freely	DELAY <input type="checkbox"/>	O.S.D. <input type="checkbox"/>		<b>When selecting OFF delay (OFF D.)</b>	ON D. <input type="checkbox"/>	OFF D. <input type="checkbox"/>	← Set a position freely	1 sec <input type="checkbox"/>	10 sec <input type="checkbox"/>	← Set a position freely	DELAY <input type="checkbox"/>	O.S.D. <input type="checkbox"/>		<b>When selecting one-shot delay (O.S.D.)</b>	DARK ON <input type="checkbox"/>	LIGHT ON <input type="checkbox"/>	← Set a position freely	2 ms (B) <input type="checkbox"/>	1 ms (A) <input type="checkbox"/>	← Set a position freely	DELAY <input type="checkbox"/>	O.S.D. <input type="checkbox"/>	Since the function has stopped, it allows in both of the positions.		ON D. <input type="checkbox"/>	OFF D. <input type="checkbox"/>	← Set a position freely		1 sec <input type="checkbox"/>	10 sec <input type="checkbox"/>		<p><b>Timing chart</b></p>  <p>Note 1. t must be longer than 1 ms or 2 ms. 2. T denotes a delay time.</p> <p><b>External synchronous input operation</b> When the external synchronous input terminal (9) is open (HIGH), the output relay performs timer operation according to the input signals (LIGHT, DARK). When the external synchronous input terminal (9) is connected to the 0 V terminal (2) (LOW), the output relay turns OFF, independently of the input signals and output status, and acts as an inhibit signal.</p>
<b>When selecting ON delay (ON D.)</b>		DARK ON <input type="checkbox"/>	LIGHT ON <input type="checkbox"/>	← Set a position freely																																			
		2 ms (B) <input type="checkbox"/>	1 ms (A) <input type="checkbox"/>	← Set a position freely																																			
	DELAY <input type="checkbox"/>	O.S.D. <input type="checkbox"/>																																					
<b>When selecting OFF delay (OFF D.)</b>	ON D. <input type="checkbox"/>	OFF D. <input type="checkbox"/>	← Set a position freely																																				
	1 sec <input type="checkbox"/>	10 sec <input type="checkbox"/>	← Set a position freely																																				
	DELAY <input type="checkbox"/>	O.S.D. <input type="checkbox"/>																																					
<b>When selecting one-shot delay (O.S.D.)</b>	DARK ON <input type="checkbox"/>	LIGHT ON <input type="checkbox"/>	← Set a position freely																																				
	2 ms (B) <input type="checkbox"/>	1 ms (A) <input type="checkbox"/>	← Set a position freely																																				
	DELAY <input type="checkbox"/>	O.S.D. <input type="checkbox"/>	Since the function has stopped, it allows in both of the positions.																																				
	ON D. <input type="checkbox"/>	OFF D. <input type="checkbox"/>	← Set a position freely																																				
	1 sec <input type="checkbox"/>	10 sec <input type="checkbox"/>																																					

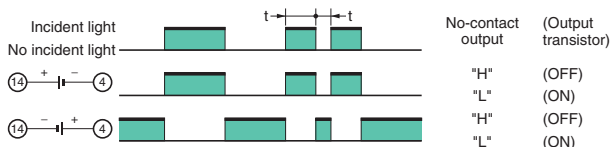
Amplifier Units	Nomenclature	Settings								
E3C-JC4P	 <p>Stability indicator (green)</p> <p>Sensitivity adjuster (4-turn endless adjuster)</p> <p>Light indicator (red)</p> <p>Operation selector</p>	---								
E3C-GE4	 <p>Stability indicator (green) When the light receiving input becomes +20% or more and -20% or less of operating voltage, it will be turned on. (Indicate stable status)</p> <p>Light indicator (red) When the light inputs, it will be turned on</p> <p>Sensitivity adjuster</p>	<p><b>Operation switching</b></p> <table border="1" data-bbox="790 716 1436 828"> <tr> <td></td> <td>DARK turns the output "H".</td> </tr> <tr> <td></td> <td>LIGHT turns the output "H".</td> </tr> </table> <p><b>Response time changing (The different frequency type can be made up by changing the response speed.)</b></p> <table border="1" data-bbox="790 896 1436 963"> <tr> <td> -0 V * connected</td> <td>The response time is set to 2 ms.</td> </tr> <tr> <td> disconnected</td> <td>The response time is set to 1 ms.</td> </tr> </table> <p>* 0 V of power supply</p> <p><b>Timing chart</b></p>  <p>Incident light</p> <p>No incident light</p> <p>14 + - 4</p> <p>14 - + 4</p> <p>No-contact output (Output transistor)</p> <p>"H" (OFF)</p> <p>"L" (ON)</p> <p>"H" (OFF)</p> <p>"L" (ON)</p>		DARK turns the output "H".		LIGHT turns the output "H".	-0 V * connected	The response time is set to 2 ms.	disconnected	The response time is set to 1 ms.
	DARK turns the output "H".									
	LIGHT turns the output "H".									
-0 V * connected	The response time is set to 2 ms.									
disconnected	The response time is set to 1 ms.									

## Safety Precautions

Refer to *Warranty and Limitations of Liability*.

### ⚠ WARNING

This product is not designed or rated for ensuring safety of persons either directly or indirectly. Do not use it for such purposes.



### Precautions for Correct Use

Do not use the product in atmospheres or environments that exceed product ratings.

#### Amplifier Units

##### ● Wiring

##### Connection of E3C-JC4P Amplifier Unit and Sensor

Always run the shielded wires of the Emitter and Receiver separately. Also, route the sensor cable along the cable grooves of the cover and sensor and fix it with the cover.

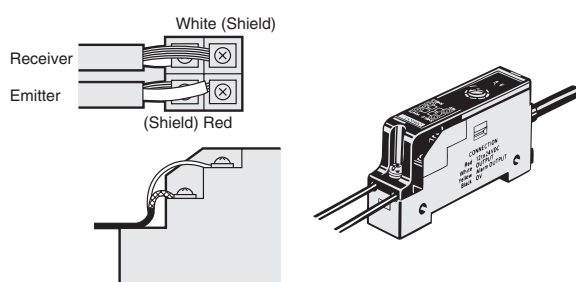

##### Connection Socket

The standard socket is the PF113A for the E3C-A and -C, and the PYF08A, PYF08M or PY08 for the E3C-GE4. Avoid using any other sockets since they may not satisfy the characteristics. (There will be no problem when the STABILITY indicator turns ON)

#### Sensor Units

##### ● Wiring

##### Extension Cable

- The extension distance of the sensor connection cable should be within 10 m.
- The strip-off length of the core in the connection cable should be 20 mm max. on the Receiver side and 50 mm max. on the Emitter side, and the core should be as short as possible. Avoid using the joint terminal and connector.

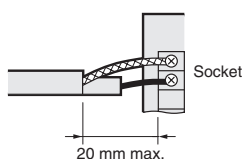

- Use independent shielded wires for the Emitter and Receiver. Using a common shielded wire can cause a malfunction.

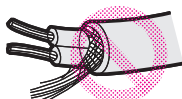

##### Extension Cable

##### Through-beam

Cable Model	Specified cable	Replacement cable
E3C-S10 E3C-1 E3C-2 E3C-S50	Polyethylene insulation shield Round cable  12-conductor, 0.18 dia.	1-conductor shield/vinyl wire, conductor cross section: 0.3 mm <sup>2</sup> min.  Gray (vinyl sheath)
E3C-S20W	Vinyl insulation shield round cable  12-conductor, 0.18 dia.	1-conductor shield/vinyl wire, conductor cross section: 0.3 mm <sup>2</sup> min.
E3C-S30T E3C-S30W	Vinyl insulation shield round cable (robot cable)  30-conductor, 0.08 dia.	1-conductor shield/vinyl wire, conductor cross section: 0.3 mm <sup>2</sup> min.

##### Reflective model

Cable Model	Specified cable	Replacement cable
E3C-DS10 E3C-DS10T E3C-VS1G E3C-VS3R E3C-LS3R	Vinyl insulation shielded parallel cable  12-conductor, 0.18 dia.	When there is no 1-conductor shielded, vinyl cable (parallel wire), use two 1-conductor shielded, vinyl wires.
E3C-DS5W E3C-VS7R E3C-VM35R	Vinyl insulation shielded parallel cable  7-conductor, 0.18 dia.	When there is no 1-conductor shielded, vinyl cable (parallel wire), use two 1-conductor shielded, vinyl wires.

##### ● Others

When the E3C is used in a place where high-frequency noise will be generated, e.g. ultrasonic welder, grounding the 0-V terminal (on the shield side of the connection cable) of the Receiver may avoid a malfunction caused by induction.

Dimensions

(Unit: mm)

Tolerance class IT16 applies to dimensions in this data sheet unless otherwise specified.

Sensors

Sensor Units

E3C-S10



Emitter: E3C-S10L  
Receiver: E3C-S10D

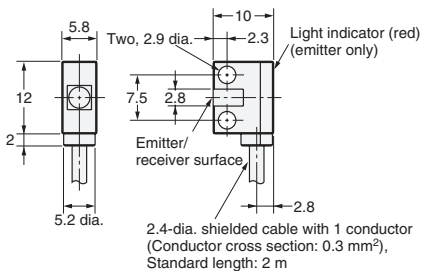

E3C-S50

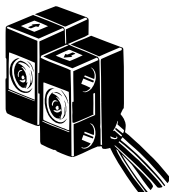

Emitter: E3C-S50L  
Receiver: E3C-S50D

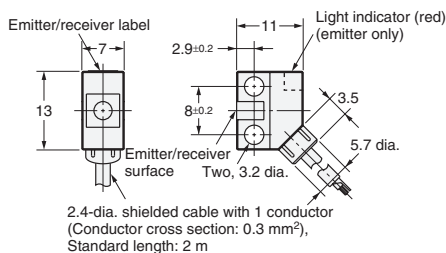

E3C-1

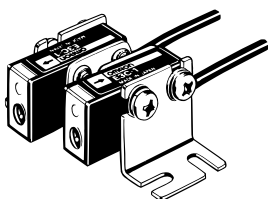

Emitter: E3C-1L  
Receiver: E3C-1D

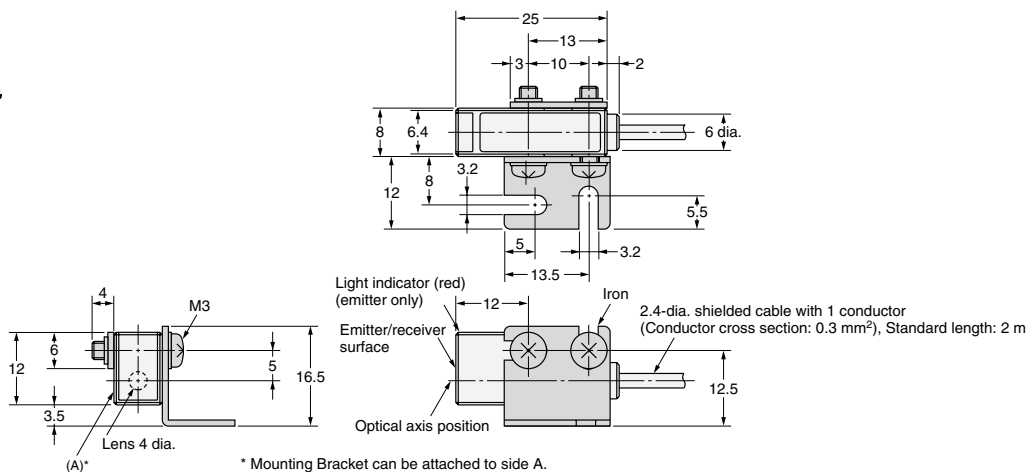

E3C-2

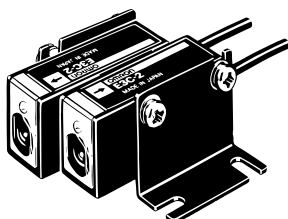

Emitter: E3C-2L  
Receiver: E3C-2D

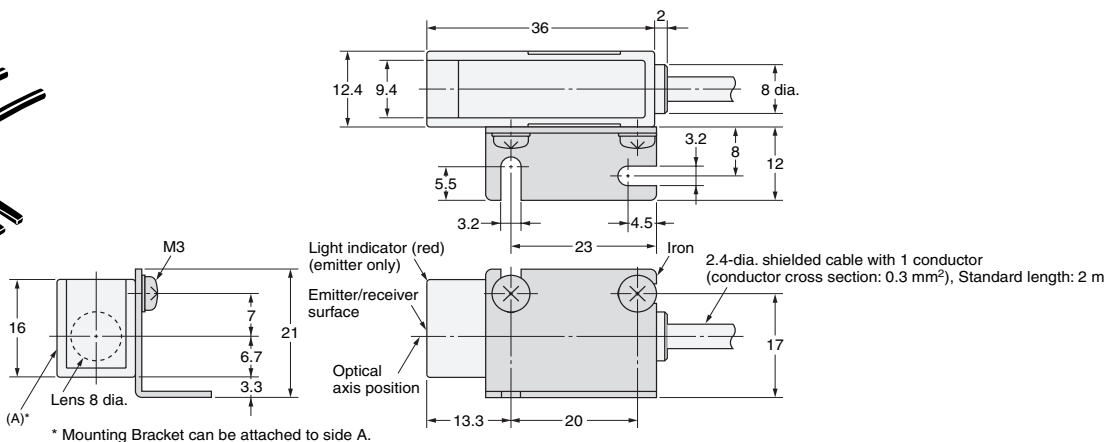

E3C-S20W

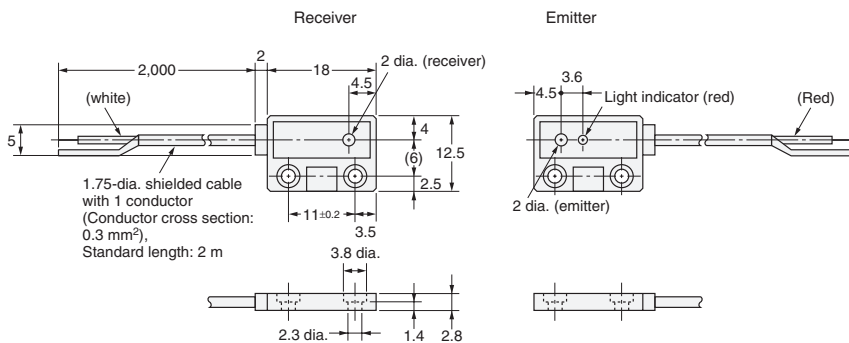
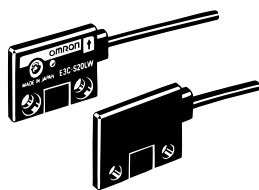

Emitter: E3C-S20LW  
Receiver: E3C-S20DW

E3C-S30W

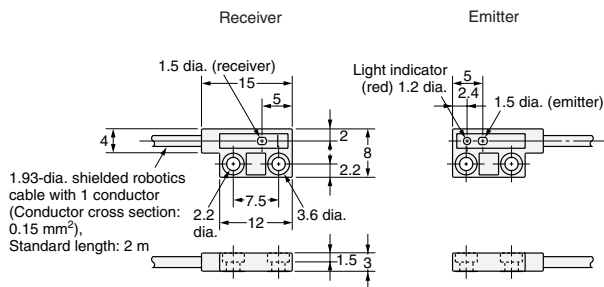
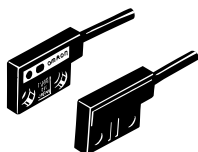

Emitter: E3C-S30LW  
Receiver: E3C-S30DW

E3C-S30T

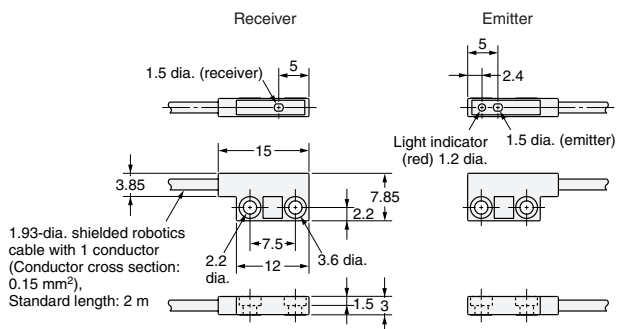
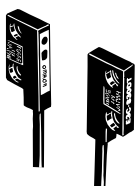

Emitter: E3C-S30LT  
Receiver: E3C-S30DT

E3C-DS10

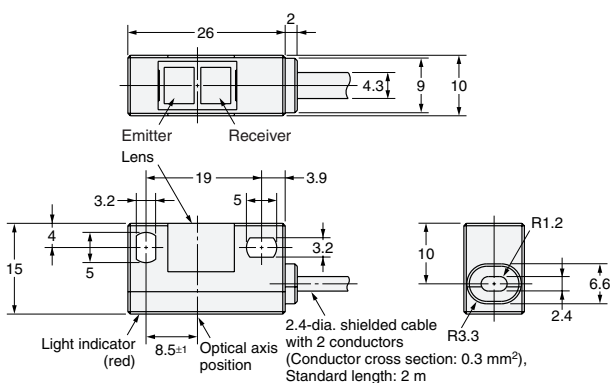
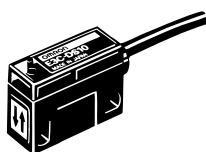



Amplifier Units

E3C-A  
E3C-C

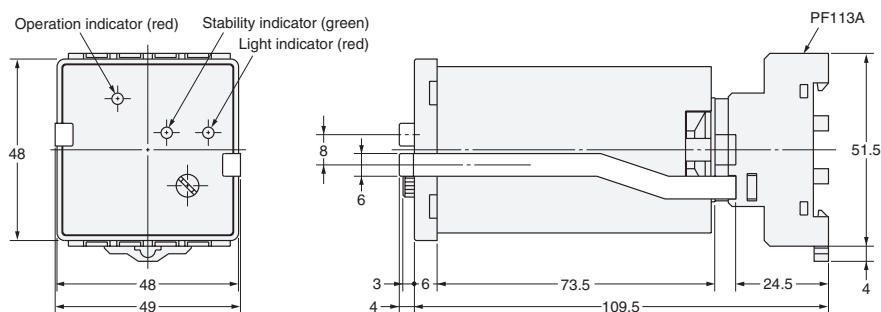
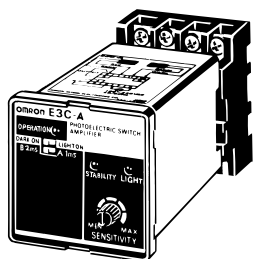

E3C-JC4P

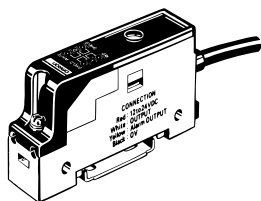

With Mounting Bracket Attached

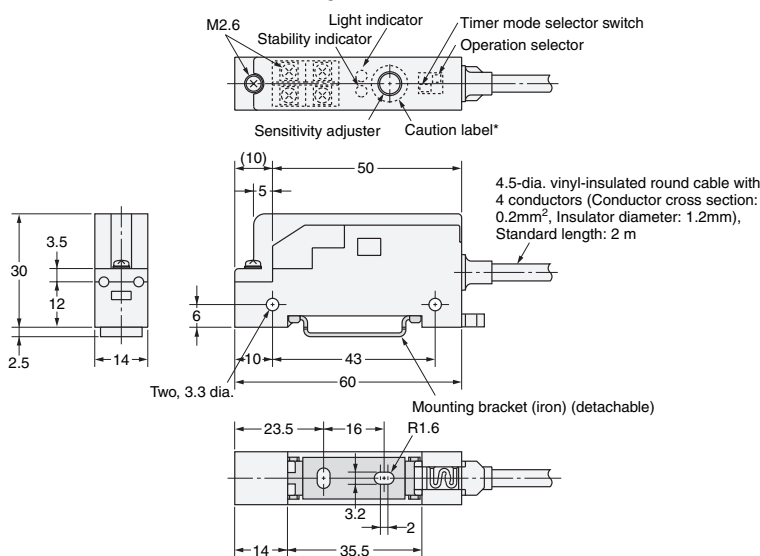

\*After adjusting the sensitivity, attach the caution label at the location indicated by  above to prevent malfunction.

E3C-GE4

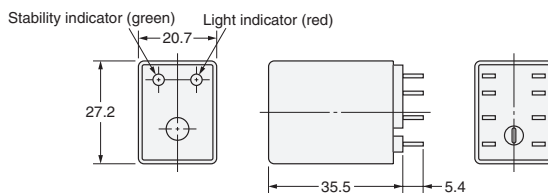

Connector

Use the PYF08A front connection socket or PY08 rear connection socket.

Accessories (Order Separately)

Mounting Brackets

Refer to E39-L/F39-L/E39-S/E39-R for details.

Connecting Sockets

Refer to E39-L/F39-L/E39-S/E39-R for details.

## Read and Understand This Catalog

Please read and understand this catalog before purchasing the products. Please consult your OMRON representative if you have any questions or comments.

## Warranty and Limitations of Liability

### WARRANTY

OMRON's exclusive warranty is that the products are free from defects in materials and workmanship for a period of one year (or other period if specified) from date of sale by OMRON.

OMRON MAKES NO WARRANTY OR REPRESENTATION, EXPRESS OR IMPLIED, REGARDING NON-INFRINGEMENT, MERCHANTABILITY, OR FITNESS FOR PARTICULAR PURPOSE OF THE PRODUCTS. ANY BUYER OR USER ACKNOWLEDGES THAT THE BUYER OR USER ALONE HAS DETERMINED THAT THE PRODUCTS WILL SUITABLY MEET THE REQUIREMENTS OF THEIR INTENDED USE. OMRON DISCLAIMS ALL OTHER WARRANTIES, EXPRESS OR IMPLIED.

### LIMITATIONS OF LIABILITY

OMRON SHALL NOT BE RESPONSIBLE FOR SPECIAL, INDIRECT, OR CONSEQUENTIAL DAMAGES, LOSS OF PROFITS OR COMMERCIAL LOSS IN ANY WAY CONNECTED WITH THE PRODUCTS, WHETHER SUCH CLAIM IS BASED ON CONTRACT, WARRANTY, NEGLIGENCE, OR STRICT LIABILITY.

In no event shall the responsibility of OMRON for any act exceed the individual price of the product on which liability is asserted.

IN NO EVENT SHALL OMRON BE RESPONSIBLE FOR WARRANTY, REPAIR, OR OTHER CLAIMS REGARDING THE PRODUCTS UNLESS OMRON'S ANALYSIS CONFIRMS THAT THE PRODUCTS WERE PROPERLY HANDLED, STORED, INSTALLED, AND MAINTAINED AND NOT SUBJECT TO CONTAMINATION, ABUSE, MISUSE, OR INAPPROPRIATE MODIFICATION OR REPAIR.

## Application Considerations

### SUITABILITY FOR USE

OMRON shall not be responsible for conformity with any standards, codes, or regulations that apply to the combination of products in the customer's application or use of the products.

At the customer's request, OMRON will provide applicable third party certification documents identifying ratings and limitations of use that apply to the products. This information by itself is not sufficient for a complete determination of the suitability of the products in combination with the end product, machine, system, or other application or use.

The following are some examples of applications for which particular attention must be given. This is not intended to be an exhaustive list of all possible uses of the products, nor is it intended to imply that the uses listed may be suitable for the products:

- Outdoor use, uses involving potential chemical contamination or electrical interference, or conditions or uses not described in this catalog.
- Nuclear energy control systems, combustion systems, railroad systems, aviation systems, medical equipment, amusement machines, vehicles, safety equipment, and installations subject to separate industry or government regulations.
- Systems, machines, and equipment that could present a risk to life or property.

Please know and observe all prohibitions of use applicable to the products.

NEVER USE THE PRODUCTS FOR AN APPLICATION INVOLVING SERIOUS RISK TO LIFE OR PROPERTY WITHOUT ENSURING THAT THE SYSTEM AS A WHOLE HAS BEEN DESIGNED TO ADDRESS THE RISKS, AND THAT THE OMRON PRODUCTS ARE PROPERLY RATED AND INSTALLED FOR THE INTENDED USE WITHIN THE OVERALL EQUIPMENT OR SYSTEM.

### PROGRAMMABLE PRODUCTS

OMRON shall not be responsible for the user's programming of a programmable product, or any consequence thereof.

## Disclaimers

### CHANGE IN SPECIFICATIONS

Product specifications and accessories may be changed at any time based on improvements and other reasons.

It is our practice to change model numbers when published ratings or features are changed, or when significant construction changes are made. However, some specifications of the products may be changed without any notice. When in doubt, special model numbers may be assigned to fix or establish key specifications for your application on your request. Please consult with your OMRON representative at any time to confirm actual specifications of purchased products.

### DIMENSIONS AND WEIGHTS

Dimensions and weights are nominal and are not to be used for manufacturing purposes, even when tolerances are shown.

### PERFORMANCE DATA

Performance data given in this catalog is provided as a guide for the user in determining suitability and does not constitute a warranty. It may represent the result of OMRON's test conditions, and the users must correlate it to actual application requirements. Actual performance is subject to the OMRON Warranty and Limitations of Liability.

### ERRORS AND OMISSIONS

The information in this document has been carefully checked and is believed to be accurate; however, no responsibility is assumed for clerical, typographical, or proofreading errors, or omissions.

2011.9

In the interest of product improvement, specifications are subject to change without notice.

**OMRON Corporation**  
Industrial Automation Company

<http://www.ia.omron.com/>

(c)Copyright OMRON Corporation 2011 All Right Reserved.





## Стандарт Электрон Связь

Мы молодая и активно развивающаяся компания в области поставок электронных компонентов. Мы поставляем электронные компоненты отечественного и импортного производства напрямую от производителей и с крупнейших складов мира.

Благодаря сотрудничеству с мировыми поставщиками мы осуществляем комплексные и плановые поставки широчайшего спектра электронных компонентов.

Собственная эффективная логистика и склад в обеспечивает надежную поставку продукции в точно указанные сроки по всей России.

Мы осуществляем техническую поддержку нашим клиентам и предпродажную проверку качества продукции. На все поставляемые продукты мы предоставляем гарантию .

Осуществляем поставки продукции под контролем ВП МО РФ на предприятия военно-промышленного комплекса России , а также работаем в рамках 275 ФЗ с открытием отдельных счетов в уполномоченном банке. Система менеджмента качества компании соответствует требованиям ГОСТ ISO 9001.

Минимальные сроки поставки, гибкие цены, неограниченный ассортимент и индивидуальный подход к клиентам являются основой для выстраивания долгосрочного и эффективного сотрудничества с предприятиями радиоэлектронной промышленности, предприятиями ВПК и научно-исследовательскими институтами России.

С нами вы становитесь еще успешнее!

### Наши контакты:

**Телефон:** +7 812 627 14 35

**Электронная почта:** [sales@st-electron.ru](mailto:sales@st-electron.ru)

**Адрес:** 198099, Санкт-Петербург,  
Промышленная ул, дом № 19, литера Н,  
помещение 100-Н Офис 331