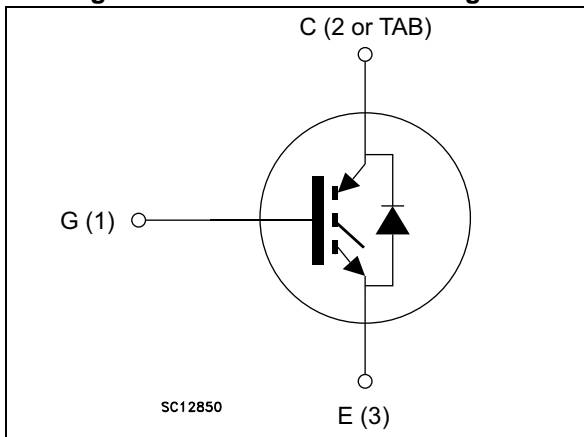

Figure 1. Internal schematic diagram



### Features

- 10  $\mu$ s of short-circuit withstand time
- $V_{CE(sat)} = 1.65$  V (typ.) @  $I_C = 40$  A
- Tight parameter distribution
- Safer paralleling
- Low thermal resistance
- Soft and fast recovery antiparallel diode

### Applications

- Industrial drives
- UPS
- Solar
- Welding

### Description

This device is an IGBT developed using an advanced proprietary trench gate field-stop structure. The device is part of the S series of 1200 V IGBTs which is tailored to maximize efficiency of low frequency industrial systems. Furthermore, a positive  $V_{CE(sat)}$  temperature coefficient and tight parameter distribution result in safer paralleling operation.

Table 1. Device summary

Order code	Marking	Package	Packing
STGW40S120DF3	G40S120DF3	TO-247	Tube
STGWA40S120DF3	G40S120DF3	TO-247 long leads	Tube

# Contents

- 1      Electrical ratings ..... 3**
- 2      Electrical characteristics ..... 4**
  - 2.1    Electrical characteristics (curves) ..... 6
- 3      Test circuits ..... 12**
- 4      Package information ..... 13**
  - 4.1    TO-247, STGW40S120DF3 ..... 13
  - 4.2    TO-247 long leads, STGWA40S120DF3 ..... 15
- 5      Revision history ..... 17**

# 1 Electrical ratings

**Table 2. Absolute maximum ratings**

Symbol	Parameter	Value	Unit
$V_{CES}$	Collector-emitter voltage ( $V_{GE} = 0$ )	1200	V
$I_C$	Continuous collector current at $T_C = 25\text{ °C}$	80	A
$I_C$	Continuous collector current at $T_C = 100\text{ °C}$	40	A
$I_{CP}^{(1)}$	Pulsed collector current	160	A
$V_{GE}$	Gate-emitter voltage	$\pm 20$	V
$I_F$	Continuous forward current at $T_C = 25\text{ °C}$	80	A
$I_F$	Continuous forward current at $T_C = 100\text{ °C}$	40	A
$I_{FP}^{(1)}$	Pulsed forward current	160	A
$P_{TOT}$	Total dissipation at $T_C = 25\text{ °C}$	468	W
$T_{STG}$	Storage temperature range	- 55 to 150	°C
$T_J$	Operating junction temperature	- 55 to 175	°C

1. Pulse width limited by maximum junction temperature.

**Table 3. Thermal data**

Symbol	Parameter	Value	Unit
$R_{thJC}$	Thermal resistance junction-case IGBT	0.32	°C/W
$R_{thJC}$	Thermal resistance junction-case diode	0.74	°C/W
$R_{thJA}$	Thermal resistance junction-ambient	50	°C/W

## 2 Electrical characteristics

$T_J = 25\text{ °C}$  unless otherwise specified

**Table 4. Static characteristics**

Symbol	Parameter	Test conditions	Min.	Typ.	Max.	Unit
$V_{(BR)CES}$	Collector-emitter breakdown voltage ( $V_{GE} = 0$ )	$I_C = 2\text{ mA}$	1200			V
$V_{CE(sat)}$	Collector-emitter saturation voltage	$V_{GE} = 15\text{ V}, I_C = 40\text{ A}$		1.65	2.15	V
		$V_{GE} = 15\text{ V}, I_C = 40\text{ A}, T_J = 125\text{ °C}$		1.9		
		$V_{GE} = 15\text{ V}, I_C = 25\text{ A}, T_J = 175\text{ °C}$		2.05		
$V_F$	Forward on-voltage	$I_F = 40\text{ A}$		2.85	3.95	V
		$I_F = 40\text{ A}, T_J = 125\text{ °C}$		2.25		V
		$I_F = 40\text{ A}, T_J = 175\text{ °C}$		2.1		V
$V_{GE(th)}$	Gate threshold voltage	$V_{CE} = V_{GE}, I_C = 2\text{ mA}$	5	6	7	V
$I_{CES}$	Collector cut-off current ( $V_{GE} = 0$ )	$V_{CE} = 1200\text{ V}$			25	$\mu\text{A}$
$I_{GES}$	Gate-emitter leakage current ( $V_{CE} = 0$ )	$V_{GE} = \pm 20\text{ V}$			250	nA

**Table 5. Dynamic characteristics**

Symbol	Parameter	Test conditions	Min.	Typ.	Max.	Unit
$C_{ies}$	Input capacitance	$V_{CE} = 25\text{ V}, f = 1\text{ MHz}, V_{GE} = 0$	-	2475	-	pF
$C_{oes}$	Output capacitance		-	185	-	pF
$C_{res}$	Reverse transfer capacitance		-	95	-	pF
$Q_g$	Total gate charge	$V_{CC} = 960\text{ V}, I_C = 40\text{ A}, V_{GE} = 15\text{ V},$ see <a href="#">Figure 30</a>	-	129	-	nC
$Q_{ge}$	Gate-emitter charge		-	19	-	nC
$Q_{gc}$	Gate-collector charge		-	68	-	nC

**Table 6. IGBT switching characteristics (inductive load)**

Symbol	Parameter	Test conditions	Min.	Typ.	Max.	Unit
$t_{d(on)}$	Turn-on delay time	$V_{CE} = 600\text{ V}$ , $I_C = 40\text{ A}$ , $V_{GE} = 15\text{ V}$ , $R_G = 15\ \Omega$ (see <a href="#">Figure 29</a> )	-	35	-	ns
$t_r$	Current rise time		-	15	-	ns
$(di/dt)_{on}$	Turn-on current slope		-	2100	-	A/ $\mu$ s
$t_{d(off)}$	Turn-off delay time		-	148	-	ns
$t_f$	Current fall time		-	264	-	ns
$E_{on}^{(1)}$	Turn-on switching losses		-	1.433	-	mJ
$E_{off}^{(2)}$	Turn-off switching losses		-	3.83	-	mJ
$E_{ts}$	Total switching losses	-	5.26	-	mJ	
$t_{d(on)}$	Turn-on delay time	$V_{CE} = 600\text{ V}$ , $I_C = 40\text{ A}$ , $R_G = 15\ \Omega$ , $V_{GE} = 15\text{ V}$ , $T_J = 175\text{ }^\circ\text{C}$ , (see <a href="#">Figure 29</a> )	-	32	-	ns
$t_r$	Current rise time		-	18	-	ns
$(di/dt)_{on}$	Turn-on current slope		-	1800	-	A/ $\mu$ s
$t_{d(off)}$	Turn-off delay time		-	154	-	ns
$t_f$	Current fall time		-	4.46	-	ns
$E_{on}^{(1)}$	Turn-on switching losses		-	2.9	-	mJ
$E_{off}^{(2)}$	Turn-off switching losses		-	5.6	-	mJ
$E_{ts}$	Total switching losses	-	8.5	-	mJ	
$t_{sc}$	Short-circuit withstand time	$V_{CC} \leq 600\text{ V}$ , $V_{GE} = 15\text{ V}$ , $T_{Jstart} \leq 150\text{ }^\circ\text{C}$ , $V_P < 1200\text{ V}$	10		-	$\mu$ s

1. Energy losses include reverse recovery of the diode.
2. Turn-off losses also include the tail of the collector current.

**Table 7. Diode switching characteristics (inductive load)**

Symbol	Parameter	Test conditions	Min.	Typ.	Max.	Unit
$t_{rr}$	Reverse recovery time	$I_F = 40\text{ A}$ , $V_R = 600\text{ V}$ , $V_{GE} = 15\text{ V}$ , $di/dt = 1000\text{ A}/\mu\text{s}$ , (see <a href="#">Figure 29</a> )	-	355	-	ns
$Q_{rr}$	Reverse recovery charge		-	2575	-	nC
$I_{rrm}$	Reverse recovery current		-	25	-	A
$dl_{rr}/dt$	Peak rate of fall of reverse recovery current during $t_b$		-	1110	-	A/ $\mu$ s
$E_{rr}$	Reverse recovery energy		-	1.12	-	mJ
$t_{rr}$	Reverse recovery time	$I_F = 40\text{ A}$ , $V_R = 600\text{ V}$ , $V_{GE} = 15\text{ V}$ , $T_J = 175\text{ }^\circ\text{C}$ , $di/dt = 1000\text{ A}/\mu\text{s}$ , (see <a href="#">Figure 29</a> )	-	667	-	ns
$Q_{rr}$	Reverse recovery charge		-	8500	-	nC
$I_{rrm}$	Reverse recovery current		-	37	-	A
$dl_{rr}/dt$	Peak rate of fall of reverse recovery current during $t_b$		-	450	-	A/ $\mu$ s
$E_{rr}$	Reverse recovery energy		-	3.9	-	mJ

## 2.1 Electrical characteristics (curves)

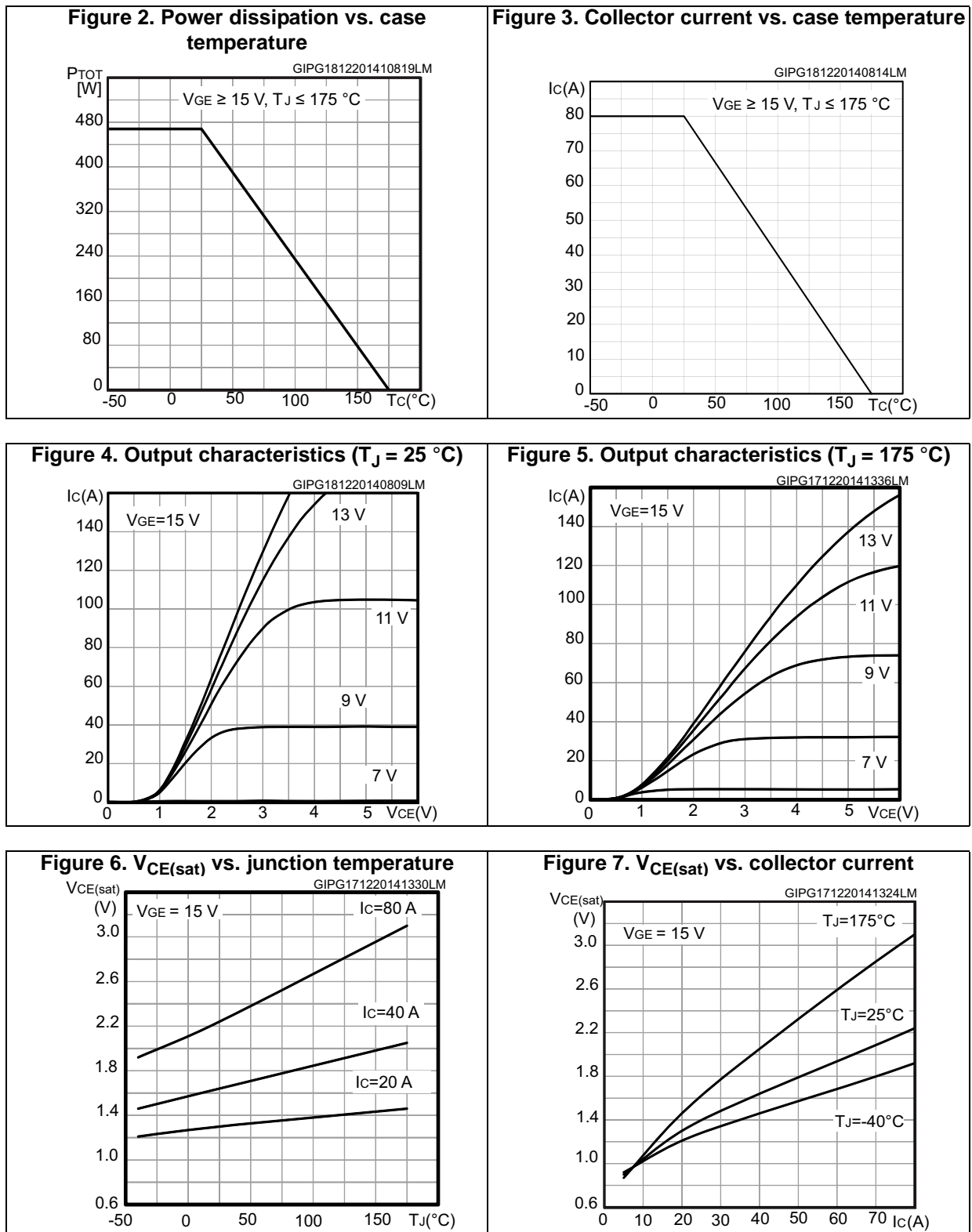

**Figure 8. Collector current vs. switching frequency**

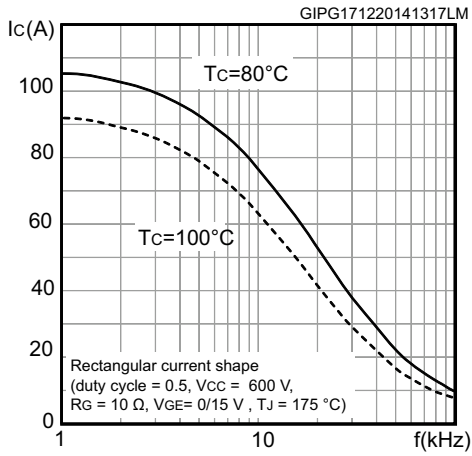

**Figure 9. Forward bias safe operating area**

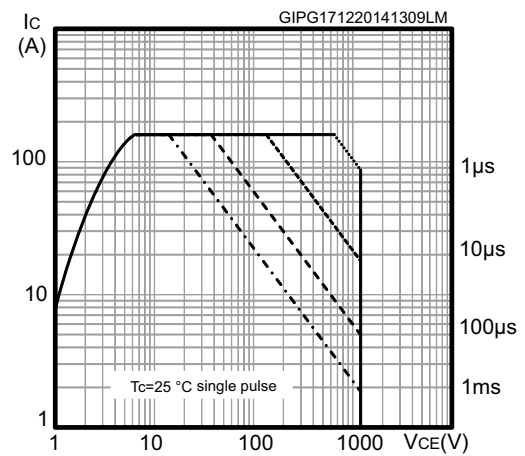

**Figure 10. Transfer characteristics**

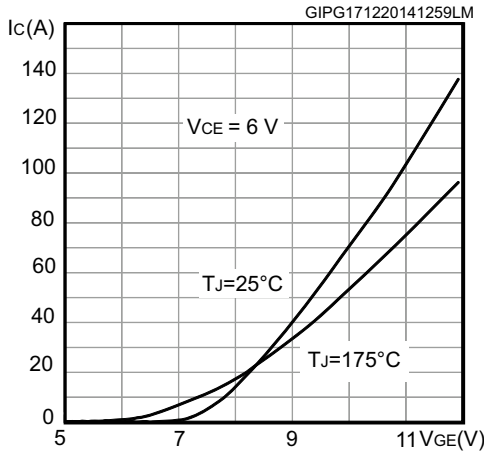

**Figure 11. Diode  $V_F$  vs. forward current**

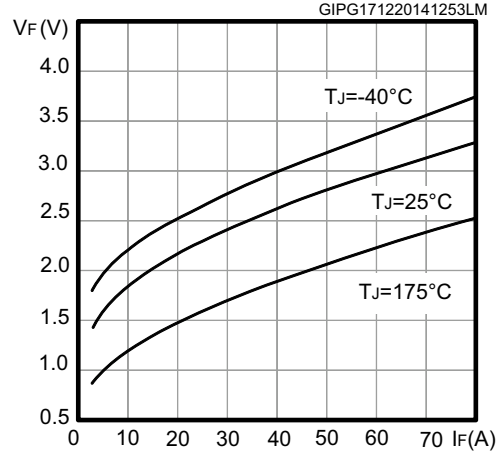

**Figure 12. Normalized  $V_{GE(th)}$  vs. junction temperature**

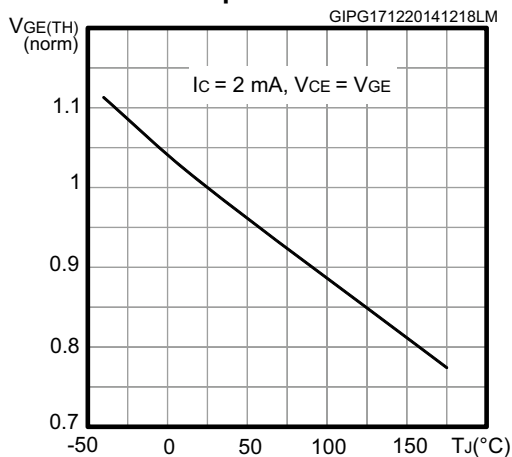

**Figure 13. Normalized  $V_{BR(CES)}$  vs. junction temperature**

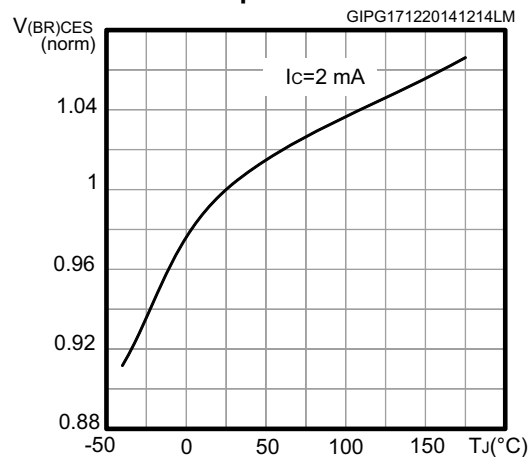

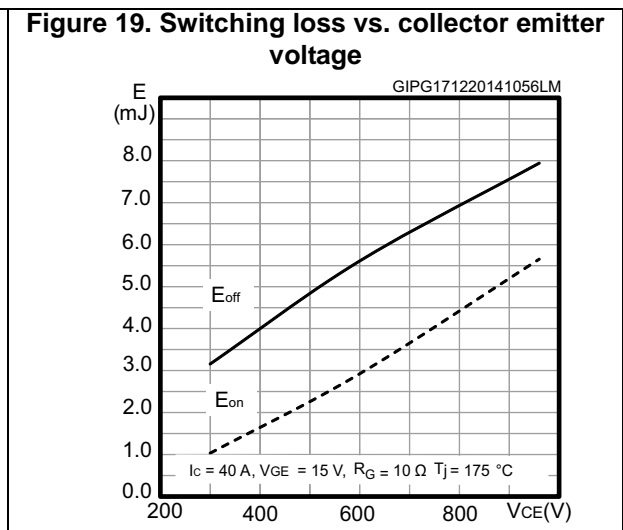
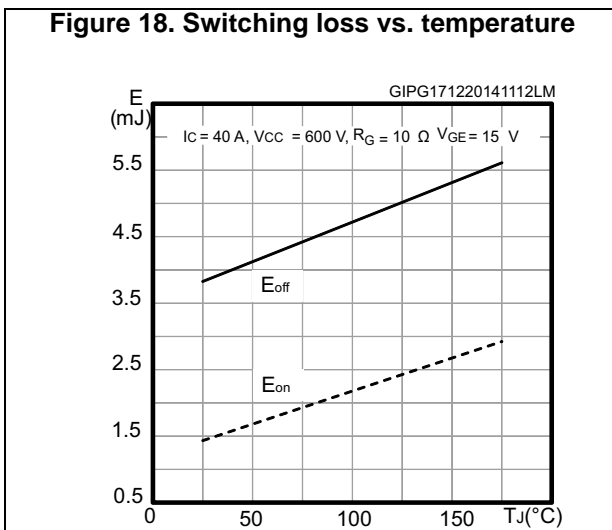
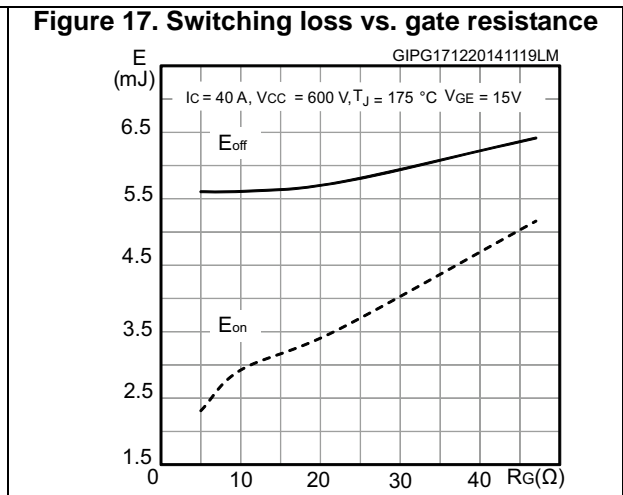
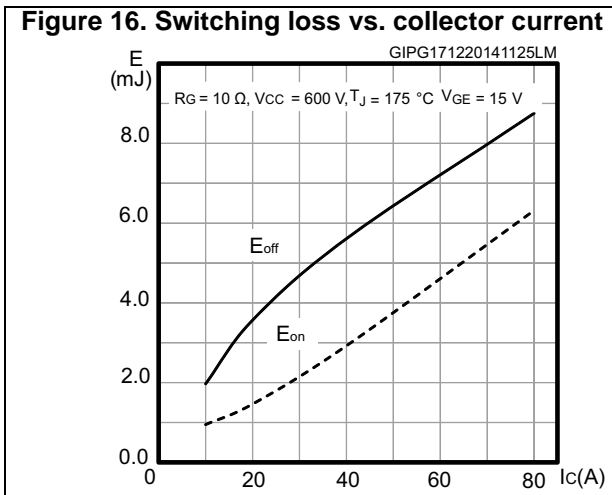
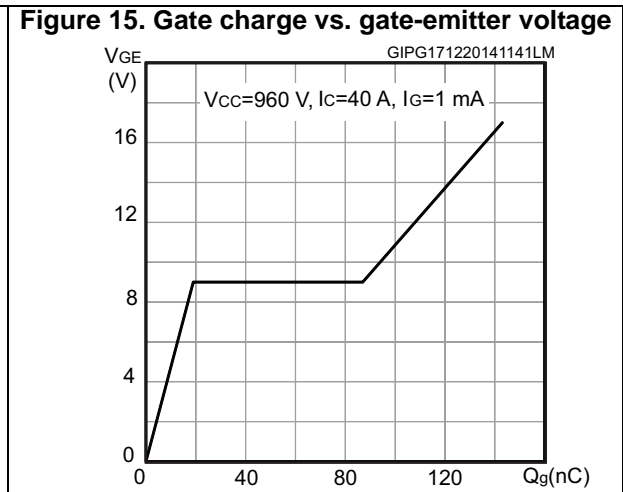
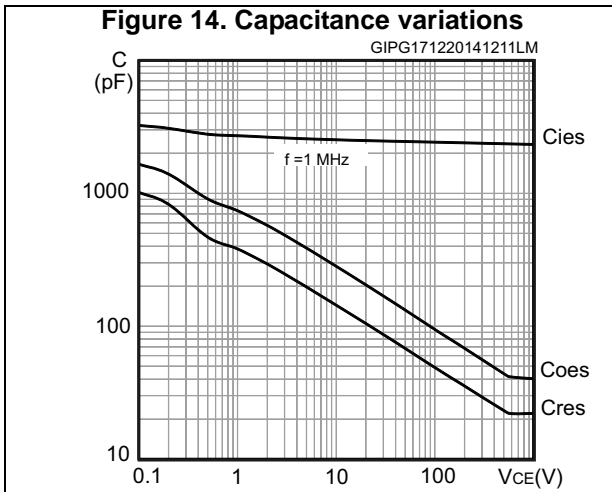



Figure 20. Short-circuit time and current vs  $V_{GE}$

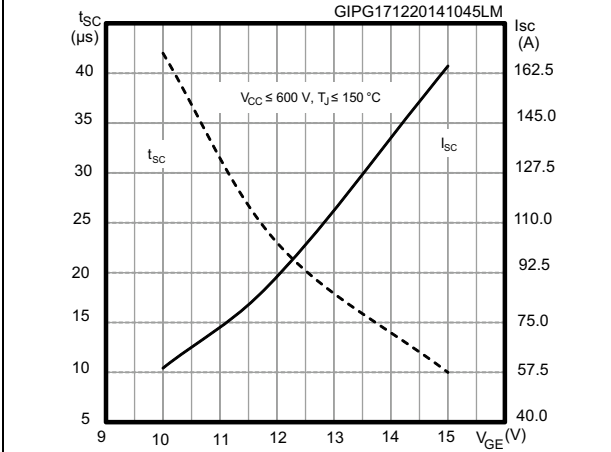

Figure 21. Switching times vs. collector current

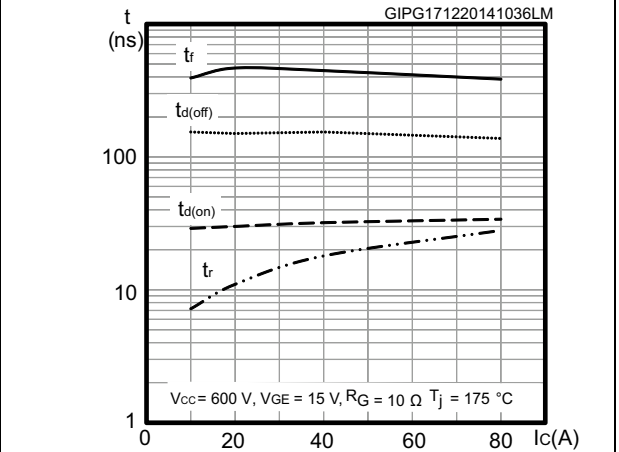

Figure 22. Switching times vs. gate resistance

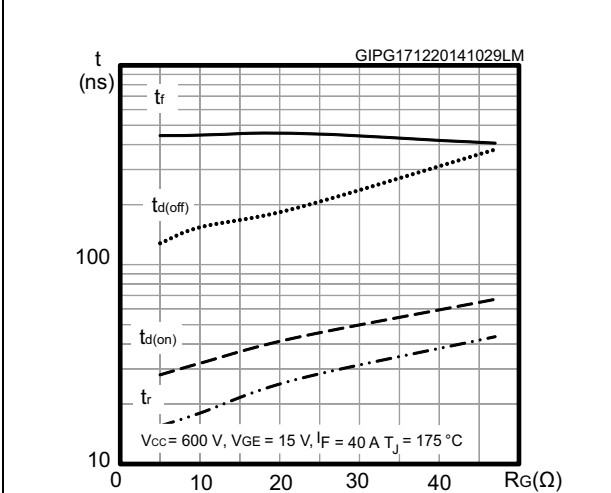

Figure 23. Reverse recovery current vs. diode current slope

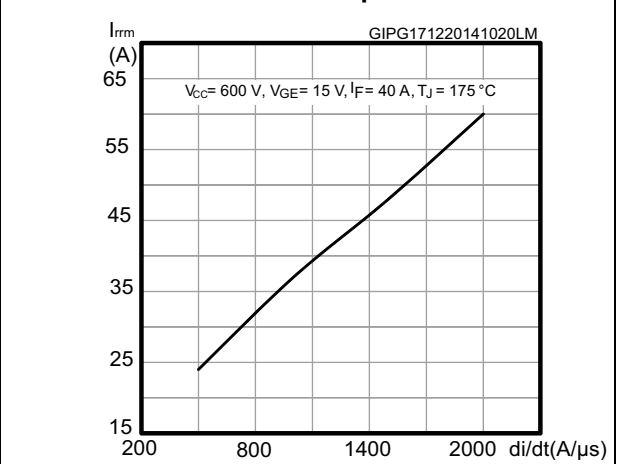

Figure 24. Reverse recovery time vs. diode current slope

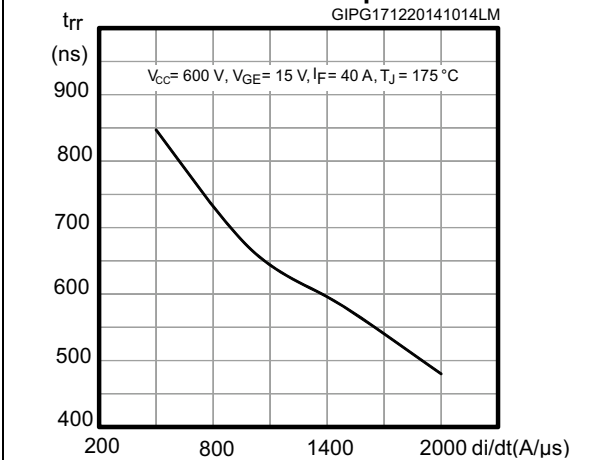
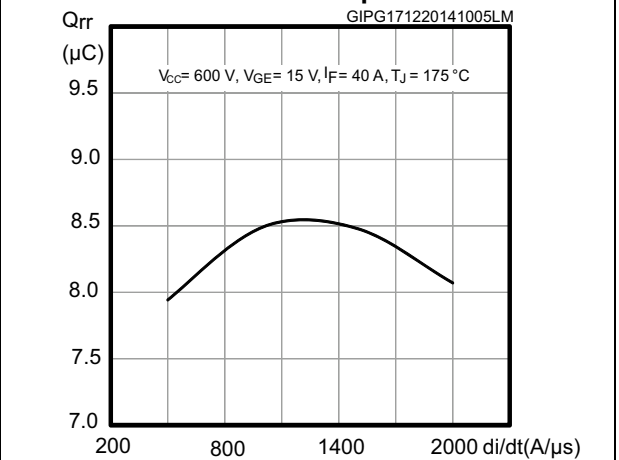

Figure 25. Reverse recovery charge vs. diode current slope



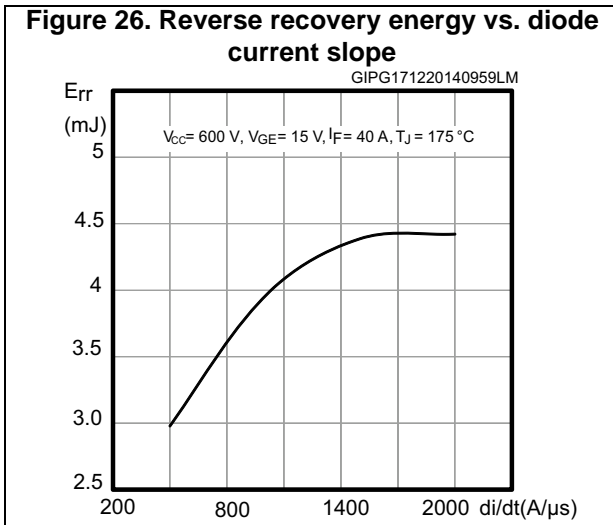

Figure 27. Thermal impedance for IGBT

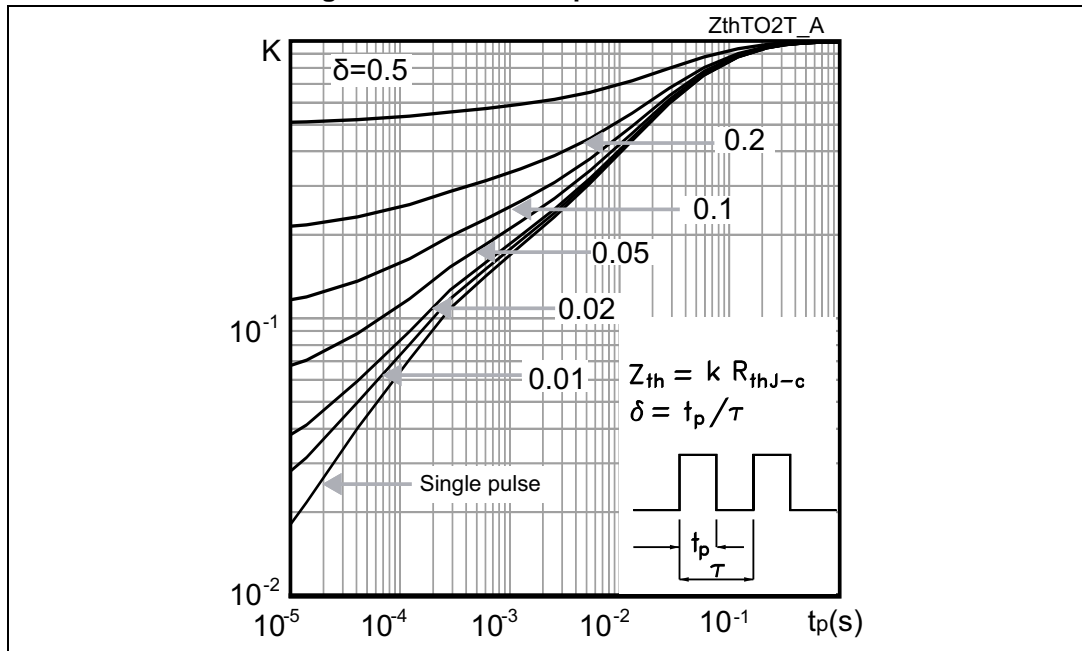
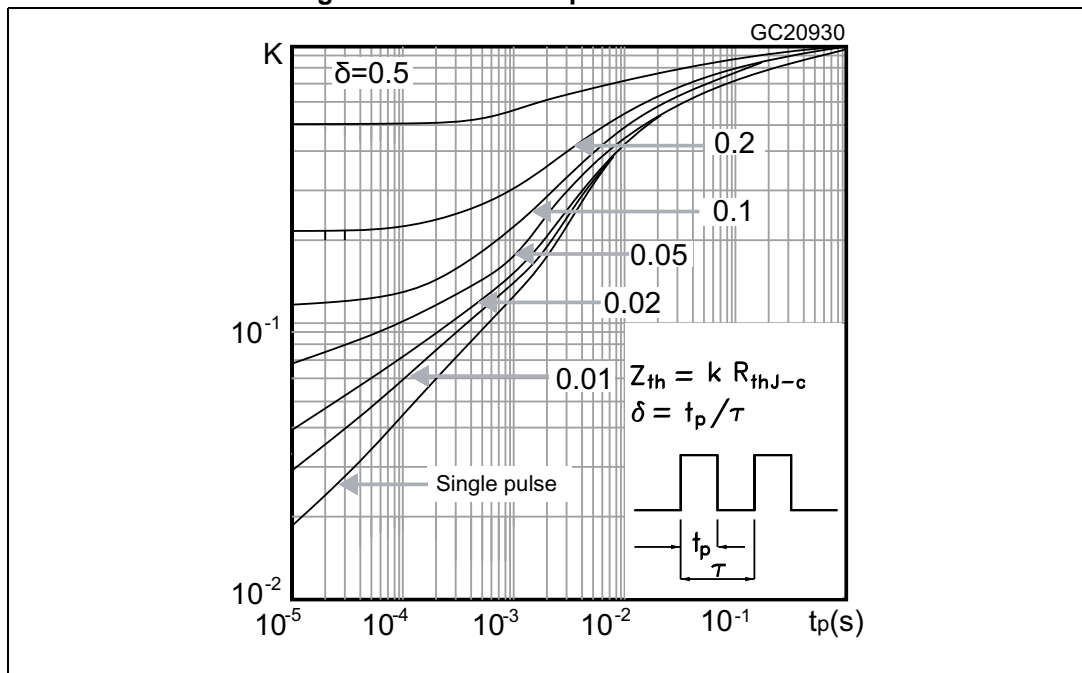

Figure 28. Thermal impedance for diode





## 4 Package information

In order to meet environmental requirements, ST offers these devices in different grades of ECOPACK® packages, depending on their level of environmental compliance. ECOPACK® specifications, grade definitions and product status are available at: [www.st.com](http://www.st.com). ECOPACK is an ST trademark.

### 4.1 TO-247, STGW40S120DF3

Figure 33. TO-247 outline

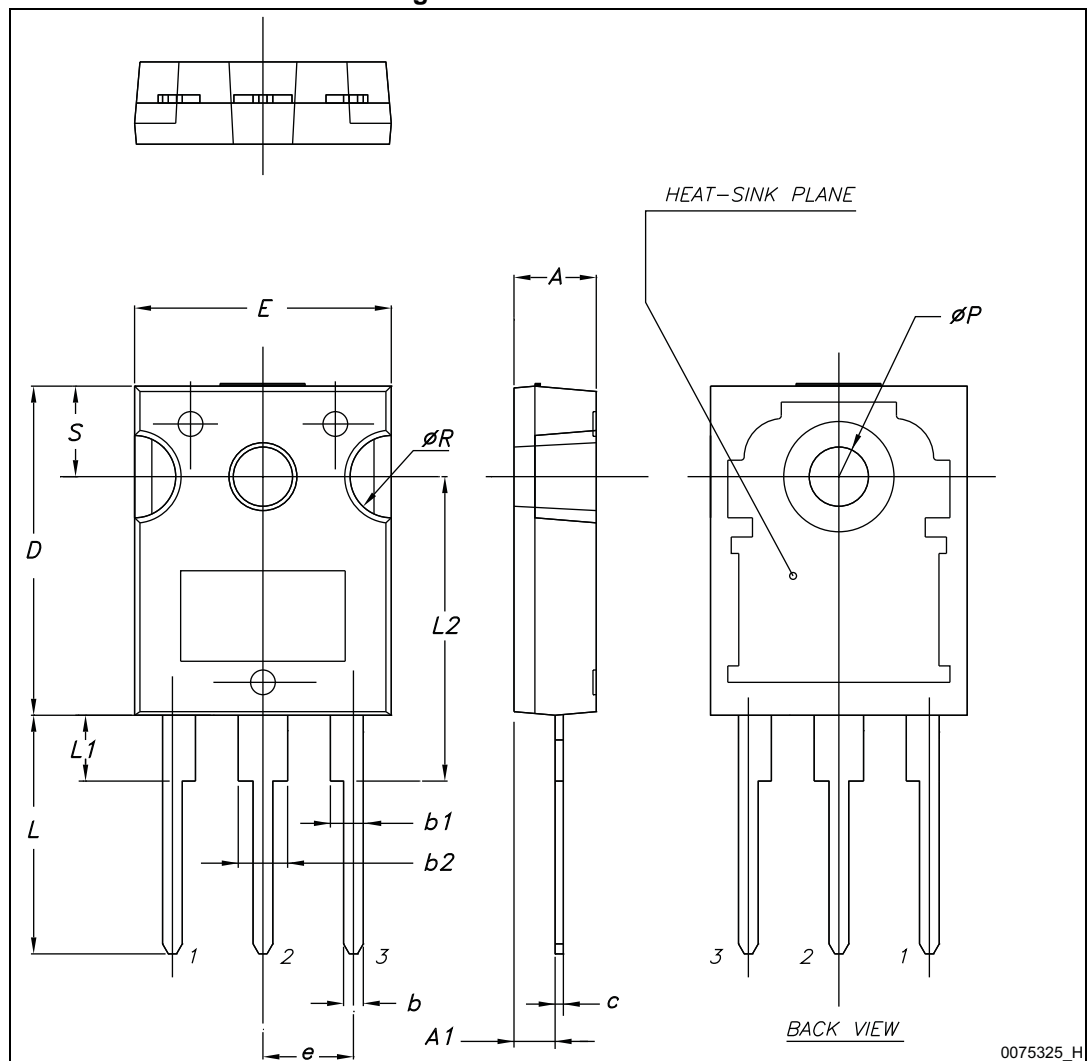
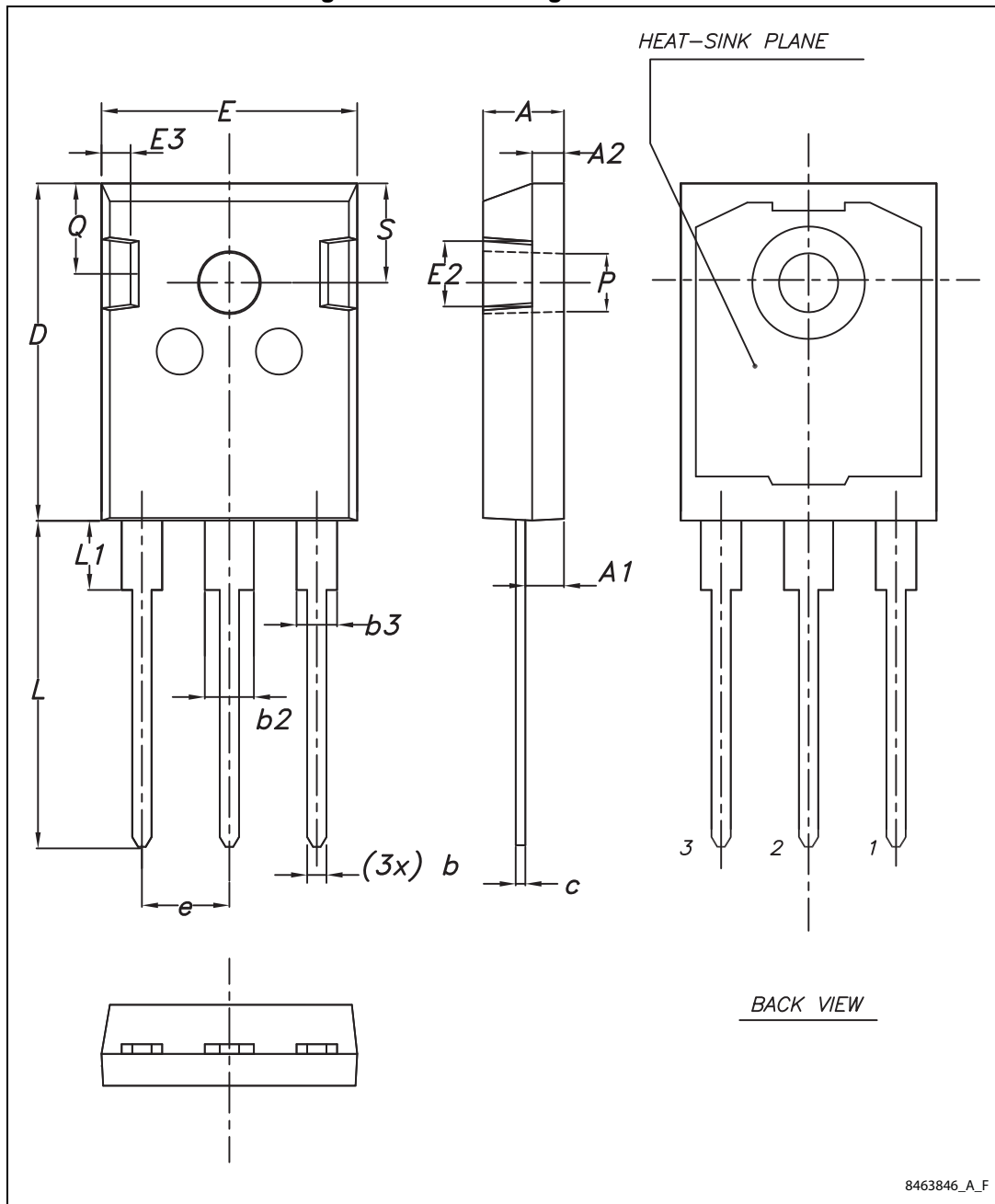

Table 8. TO-247 mechanical data

Dim.	mm.		
	Min.	Typ.	Max.
A	4.85		5.15
A1	2.20		2.60
b	1.0		1.40
b1	2.0		2.40
b2	3.0		3.40
c	0.40		0.80
D	19.85		20.15
E	15.45		15.75
e	5.30	5.45	5.60
L	14.20		14.80
L1	3.70		4.30
L2		18.50	
ØP	3.55		3.65
ØR	4.50		5.50
S	5.30	5.50	5.70

4.2 TO-247 long leads, STGWA40S120DF3

Figure 34. TO-247 long lead outline



8463846\_A\_F

Table 9. TO-247 long leads mechanical data

Dim.	mm		
	Min.	Typ.	Max.
A	4.90	5.00	5.10
A1	2.31	2.41	2.51
A2	1.90	2.00	2.10
b	1.16		1.26
b2			3.25
b3			2.25
c	0.59		0.66
D	20.90	21.00	21.10
E	15.70	15.80	15.90
E2	4.90	5.00	5.10
E3	2.40	2.50	2.60
e	5.34	5.44	5.54
L	19.80	19.92	20.10
L1			4.30
P	3.50	3.60	3.70
Q	5.60		6.00
S	6.05	6.15	6.25



## 5 Revision history

Table 10. Document revision history

Date	Revision	Changes
16-May-2014	1	Initial release.
18-Dec-2014	2	Updated <a href="#">Section 1: Electrical ratings</a> and <a href="#">Section 2: Electrical characteristics</a> . Inserted <a href="#">Section 2.1: Electrical characteristics (curves)</a> . Updated <a href="#">Section 4: Package information</a> .

**IMPORTANT NOTICE – PLEASE READ CAREFULLY**

STMicroelectronics NV and its subsidiaries ("ST") reserve the right to make changes, corrections, enhancements, modifications, and improvements to ST products and/or to this document at any time without notice. Purchasers should obtain the latest relevant information on ST products before placing orders. ST products are sold pursuant to ST's terms and conditions of sale in place at the time of order acknowledgement.

Purchasers are solely responsible for the choice, selection, and use of ST products and ST assumes no liability for application assistance or the design of Purchasers' products.

No license, express or implied, to any intellectual property right is granted by ST herein.

Resale of ST products with provisions different from the information set forth herein shall void any warranty granted by ST for such product.

ST and the ST logo are trademarks of ST. All other product or service names are the property of their respective owners.

Information in this document supersedes and replaces information previously supplied in any prior versions of this document.

© 2014 STMicroelectronics – All rights reserved



## Стандарт Электрон Связь

Мы молодая и активно развивающаяся компания в области поставок электронных компонентов. Мы поставляем электронные компоненты отечественного и импортного производства напрямую от производителей и с крупнейших складов мира.

Благодаря сотрудничеству с мировыми поставщиками мы осуществляем комплексные и плановые поставки широчайшего спектра электронных компонентов.

Собственная эффективная логистика и склад в обеспечивает надежную поставку продукции в точно указанные сроки по всей России.

Мы осуществляем техническую поддержку нашим клиентам и предпродажную проверку качества продукции. На все поставляемые продукты мы предоставляем гарантию .

Осуществляем поставки продукции под контролем ВП МО РФ на предприятия военно-промышленного комплекса России , а также работаем в рамках 275 ФЗ с открытием отдельных счетов в уполномоченном банке. Система менеджмента качества компании соответствует требованиям ГОСТ ISO 9001.

Минимальные сроки поставки, гибкие цены, неограниченный ассортимент и индивидуальный подход к клиентам являются основой для выстраивания долгосрочного и эффективного сотрудничества с предприятиями радиоэлектронной промышленности, предприятиями ВПК и научно-исследовательскими институтами России.

С нами вы становитесь еще успешнее!

### Наши контакты:

**Телефон:** +7 812 627 14 35

**Электронная почта:** [sales@st-electron.ru](mailto:sales@st-electron.ru)

**Адрес:** 198099, Санкт-Петербург,  
Промышленная ул, дом № 19, литера Н,  
помещение 100-Н Офис 331