

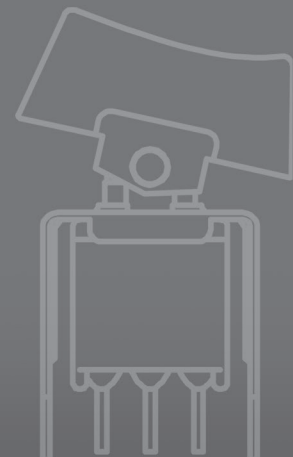







audio  
automotive  
aerospace  
communication devices  
consumer appliances  
consumer electronics  
datacom  
data storage  
handheld devices  
industrial  
industrial equipment  
instrumentation  
medical  
military  
mobile phones  
portable tools  
pumps & motors  
security alarms  
telecom  
test equipment  
thermostatic controls









# rocker

# Rockers

## Product Selection Guide



Rocker							
<b>Series</b>	7000	E	ET	T	9000	DA	D
<b>Switch Type</b>	Miniature	Miniature	Subminiature	Subminiature	Power Rocker & Lever Handle	Miniature Power	Miniature Power
<b>Poles/Throws</b>	SPDT, DPDT, 3PDT, 4PDT	SPDT, DPDT, 3PDT	SPST, SPDT, DPDT	SPST, SPDT, DPDT	DPDT	SPST, SPDT	SPST, SPDT, DPST, DPDT
<b>Max. Current</b>	5 Amps	7.5 Amps	3 Amps	3 Amps	10 Amps	16 Amps 10 Amps	4 Amps 10 Amps
<b>Washable</b>		•	•				
<b>Illuminated</b>						•	
<b>Panel Mount Options</b>							
Front Mount	•	•		•	•	Snap-in	Snap-in
Rear Mount	•	•		•	•		
<b>PCB Mount Options</b>							
Vertical	•	•	•	•	•	•	•
Right Angle	•	•	•	•	•	•	•
Surface Mount			•				
<b>Page No.</b>	G-4	G-26	G-40	G-46	G-52	G-57	G-61

Rocker							
<b>Series</b>	DM	DM	DF	CR	SW	CG	CL
<b>Switch Type</b>	Miniature 2 Pole Power	Miniature Illuminated Power	Power	Round	Miniature Power	Power	Power
<b>Poles/Throws</b>	DPST, DPDT	SPST, DPST	SPST, SPDT, DPST	SPST, SPDT	SPST, SPDT, DPST	SPST, SPDT	SPST, SPDT
<b>Max. Current</b>	3 Amps, 10 Amps	3 Amps, 10 Amps	16 Amps	10 Amps, 6 Amps	3 A, 6 A, 6.5 A, 10 A, 16 A	10 Amps 16 Amps	10 Amps 16 Amps
<b>Washable</b>							
<b>Illuminated</b>		•		•	•	•	•
<b>Panel Mount Options</b>							
Front Mount	Snap-in	Snap-in	Snap-in	Snap-in	Snap-in	Snap-in	Snap-in
Rear Mount			•				
<b>PCB Mount Options</b>							
Vertical							
Right Angle			•				
Surface Mount							
<b>Page No.</b>	G-66	G-70	G-74	G-78	G-82	G-83	G-87



# Rockers

## Product Selection Guide

<b>Rocker</b>		
<b>Series</b>	<b>CM</b>	<b>CN</b>
<b>Switch Type</b>	Power	Power
<b>Poles/Throws</b>	SPDT, DPDT	DPST, DPDT
<b>Max. Current</b>	10 Amps 16 Amps	10 Amps 16 Amps
<b>Washable</b>		
<b>Illuminated</b>	•	•
<b>Panel Mount Options</b>		
Front Mount	Snap-in	Snap-in
Rear Mount		
<b>PCB Mount Options</b>		
Vertical		
Right Angle		
Surface Mount		
<b>Page No.</b>	G-91	G-95

# 7000 Series Miniature Rocker & Lever Handle Switches

## Features/Benefits

- Multi-pole and multi-position
- Wide variety of actuator and termination options
- Epoxy terminal-seal compatible with bottom wash cleaning
- RoHS compliant

## Typical Applications

- Telecommunications
- Instrumentation
- Medical equipment

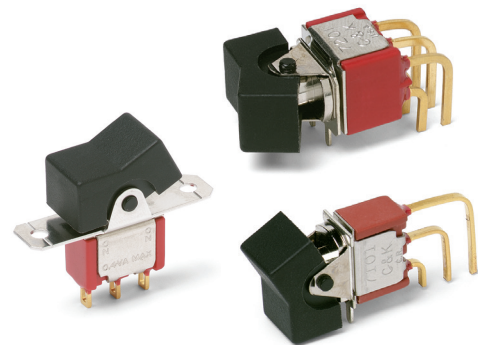

## Specifications

CONTACT RATING: B contact material: 0.4 VA max. @ 20 V AC or DC max. Q contact material: 5 AMPS @ 120 V AC or 28 V DC; 2 AMPS @ 250 V AC. See page G-20 for additional ratings.

ELECTRICAL LIFE: 7X01 and UX1 models: 100,000 make-and-break cycles at full load. All other models: 40,000 cycles.

CONTACT RESISTANCE: Below 10 m Ω typ. initial @ 2-4 V DC, 100 mA, for both silver and gold plated contacts.

INSULATION RESISTANCE: 10<sup>9</sup> Ω min.

DIELECTRIC STRENGTH: 1000 Vrms min. @ sea level.

OPERATING TEMPERATURE: -30°C to 85°C.

SOLDERABILITY: Per MIL-STD-202F method 208D, or EIA RS-186E method 9 (1 hour steam aging).

**NOTE:** Any models supplied with S, P, R, Q, B or G contact material are RoHS compliant.

**NOTE:** Specifications and materials listed above are for switches with standard options. For information on specific and custom switches, consult Customer Service Center.

## Materials

CASE: Glass filled nylon 6/6, flame retardant, heat stabilized, or diallyl phthalate (DAP) (UL 94V-0).

ACTUATOR: Nylon, black.

FRAME (FRONT MOUNT): Nylon, black.

FRAME (REAR MOUNT): Spring steel, black.

BUSHING: Brass or zinc, nickel plated.

HOUSING: Stainless steel.

SWITCH SUPPORT: Brass or steel, matte-tin plated.

END CONTACTS: B contact material: Copper alloy, with gold plate over nickel plate. Q contact material: Coin silver, silver plated. See page G-20 for additional contact materials.

CENTER CONTACTS & ALL TERMINALS: B contact material: Copper alloy, with gold plate over nickel plate. Q contact material: Copper alloy, silver plated. See page G-20 for additional contact materials.

TERMINAL SEAL: Epoxy. Refer to Soldering and Cleaning in Technical Data Section

HARDWARE: Mounting nuts & screws: Brass. Lockwasher: Stainless steel. Standoff: Nylon standard.

## Build-A-Switch

To order, simply select desired option from each category and place in the appropriate box. Available options are shown and described on pages G-4 through G-24. For additional options not shown in catalog, consult Customer Service Center. All models have epoxy terminal seal and are compatible with all "bottom-wash" PCB cleaning methods.

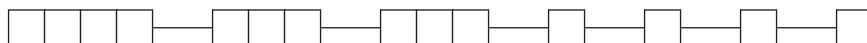

### Switch Function

- 7101 SP On-None-On
- 7103 SP On-Off-On
- 7105 SP Mom.-Off-Mom.
- 7107 SP On-Off-Mom.
- 7108 SP On-None-Mom.
- 7109 SP None-On-Mom.
- 7201 DP On-None-On
- 7203 DP On-Off-On
- 7205 DP Mom.-Off-Mom.
- 7207 DP On-Off-Mom.
- 7208 DP On-None-Mom.
- 7211 DP On-On-On
- 7213 DP On-On-Mom.
- 7215 DP Mom.-On-Mom.
- 7301 3P On-None-On
- 7303 3P On-Off-On
- 7401 4P On-None-On
- 7405 4P Mom.-Off-Mom.
- 7411 4P On-On-On

**Note:** UL models available, see pages G-5 and G-6.

### Actuator

- J1 .531" long rocker
- J2 Lever
- J3 .906" long rocker
- J10 1.318" long rocker
- J11 Rocker with frame
- J15 Rocker, snap-in
- J16 Rocker with frame, snap-in
- J19 Rocker with frame
- J21 Lever with frame
- J25 Lever, snap-in
- J26 Lever with frame, snap-in
- J37 Rocker with frame
- J50 Rocker
- J51 Rocker with frame
- J52 Rocker with frame for LED, snap-in
- J60 Lever
- J61 Lever with frame, snap-in
- J62 Lever with frame for LED, snap-in
- J90 Lever
- J91 Lever with frame, snap-in

### Terminations

- A Right angle, PC thru-hole
- AV2 Vertical right angle, PC thru-hole
- C PC Thru-hole
- Z Solder lug
- A3 Right angle, snap-in, PC thru-hole
- AV3 Vertical right angle, snap-in, PC thru-hole
- AW3 Right angle, extended, PC thru-hole
- V2 .555" high, V-bracket
- V3 .460" high, V-bracket
- V4 .630" high, V-bracket
- V5 Vertical right angle, PC thru-hole
- V6 .460" high, V-bracket
- V7 .630" high, V-bracket
- V8 .953" high, V-bracket
- V9 1.150" high, V-bracket
- V31 .460" high, V-bracket, snap-in
- V51 Vertical right angle, snap-in
- V61 .460" high, V-bracket, snap-in
- W .750" long, wire wrap
- W3 .425" long, wire wrap
- W5 1.305" long, wire wrap
- Z3 Quick connect

### Contact Material

- B Gold
- P Gold, matte tin
- Q Silver
- S Silver, matte-tin
- G Gold over silver
- R Gold over silver, matte-tin

### Seal

- E Epoxy
- I Epoxy potted base

### Actuator Color

- 2 Black
- 1 White
- 3 Red

### Frame Color

- 2 Black
- NONE No frame color required
- 1 White

### Metal Frame Color

- (J11, J19, J21 & J37 Actuators)
- 2 Black
  - 1 White

Rocker

G



27 mar 17

# 7000 Series Miniature Rocker & Lever Handle Switches

## SWITCH FUNCTION

NO. POLES	MODEL NO.	UL** MODEL NO.	SWITCH FUNCTION			CONNECTED TERMINALS			SCHEMATIC
			POS. 1	POS. 2	POS. 3	POS. 1	POS. 2	POS. 3	
SP	<b>7101</b>	<b>U11</b>	ON	NONE	ON	2-3	N/A	2-1	
	<b>7103</b>	<b>U13</b>	ON	OFF	ON				
	<b>7105</b>	<b>U15</b>	MOM.	OFF	MOM.				
	<b>7107</b>	<b>U17</b>	ON	OFF	MOM.				
	<b>7108</b>	<b>U18</b>	ON	NONE	MOM.				
	<b>7109</b>	<b>U19</b>	NONE	ON	MOM.				
			N/A	2-3	2-1	SPDT			

### SPDT

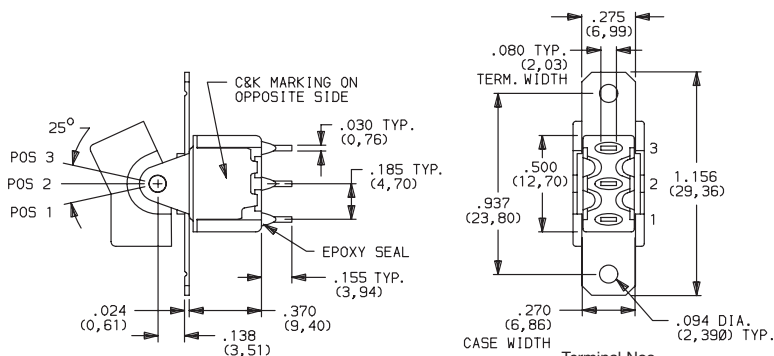

Part number shown: 7101J1ZQE2

Terminal Nos.  
For Reference Only

DP	<b>7201</b>	<b>U21</b>	ON	NONE	ON	2-3-5-6	N/A	2-1,5-4	
	<b>7203</b>	<b>U23</b>	ON	OFF	ON				
	<b>7205</b>	<b>U25</b>	MOM.	OFF	MOM.				
	<b>7207</b>	<b>U27</b>	ON	OFF	MOM.				
	<b>7208</b>	<b>U28</b>	ON	NONE	MOM.				
	<b>7211*</b>	<b>U211*</b>	ON	ON	ON				
	<b>7213*</b>	<b>U213*</b>	ON	ON	MOM.				
	<b>7215*</b>	<b>U215*</b>	MOM.	ON	MOM.				
			2-3-5-4	DPDT					

### DPDT

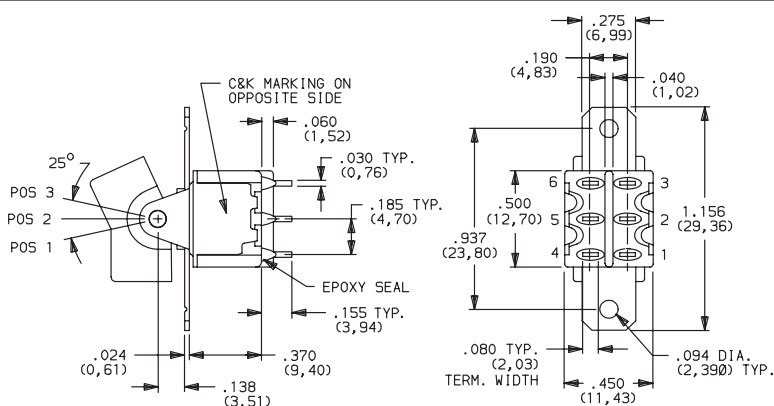

Part number shown: 7201J1ZQE2

Terminal Nos.  
For Reference Only

MOM. = Momentary

\* Wiring for 3-way switch, see Section N.

\*\* U11 through U413 model nos. with all options when ordered with G, Q, R or S contact material.

# 7000 Series Miniature Rocker & Lever Handle Switches

## SWITCH FUNCTION

NO. POLES	MODEL NO.	UL** MODEL NO.	SWITCH FUNCTION			CONNECTED TERMINALS			SCHEMATIC
			POS. 1	POS. 2	POS. 3	POS. 1	POS. 2	POS. 3	
3P	<b>7301</b>	<b>U31</b>	ON	NONE	ON	2-3,5-6,8-9	N/A	2-1,5-4,8-7	 3PDT
	<b>7303</b>	<b>U33</b>	ON	OFF	ON	2-3,5-6,8-9	OPEN	2-1,5-4,8-7	

### 3PDT

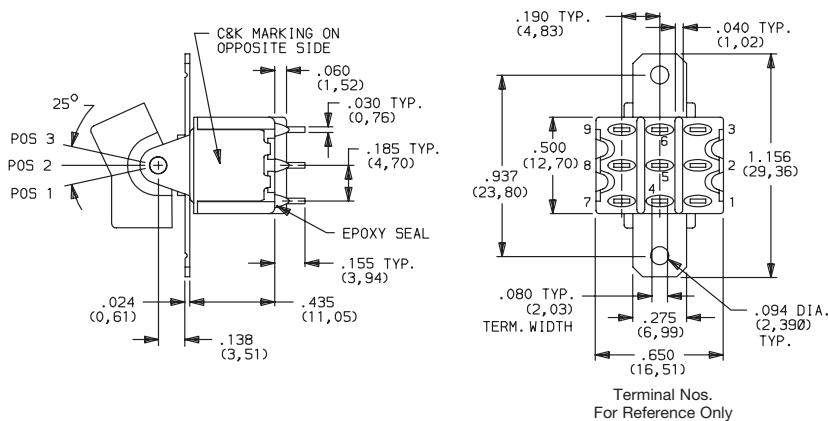

Part number shown: 7301J1ZQE2

4P	<b>7401</b>	<b>U41</b>	ON	NONE	ON	2-3,5-6,8-9,11-12	N/A	2-1,5-4,8-7,11-10	 4PDT
	<b>7405</b>	<b>U45</b>	MOM.	OFF	MOM.		OPEN		
	<b>7411*</b>	<b>U411*</b>	ON	ON	ON		2-3,5-4,8-9,11-10		

### 4PDT

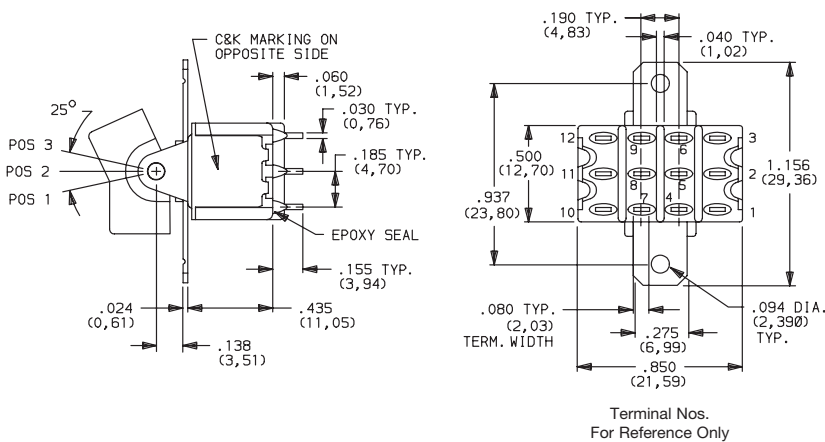

Part number shown: 7401J1ZQE2

MOM. = Momentary

\*\* U11 through U411 model nos. with all options when ordered with G, Q, R or S contact material.

\* Wiring for 3-way switch: See Technical Data section of this catalog for RoHS compliant and compatible definitions and specifications.

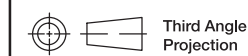

Third Angle Projection  
Dimensions are shown: Inches (mm)  
Specifications and dimensions subject to change



27 mar 17

# 7000 Series Miniature Rocker & Lever Handle Switches

## ACTUATOR-PANEL REAR MOUNT

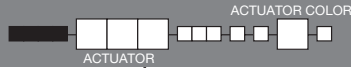

### J1 ROCKER

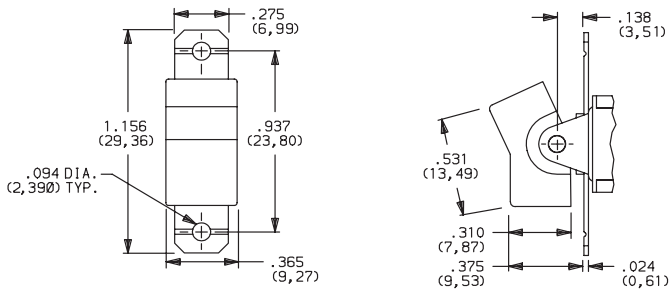

OPTION CODE	ACTUATOR COLOR
2	BLACK
1	WHITE
3	RED

Finish: Matte. Other colors, custom actuator markings and legends available, consult Customer Service Center.

**NOTE:** Hardware: two each—mounting screws, nuts, lockwashers and standoffs for 1/8 inch thick panel are supplied standard on all switches with panel mounting brackets. Actuators available separately, see page G-21 through G-22. Hardware is available see Technical Data section of this catalog.

J1, J2, J3 & J10 Actuators available with C, W-W5, Z or Z3 terminations.

### J2 LEVER

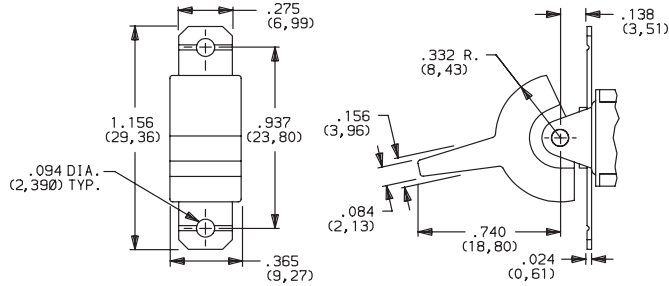

#### PANEL MOUNTING

##### J1 & J2 Actuators

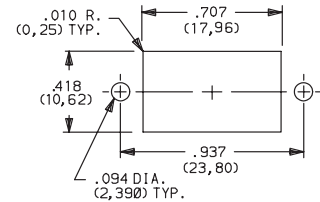

### J3 ROCKER

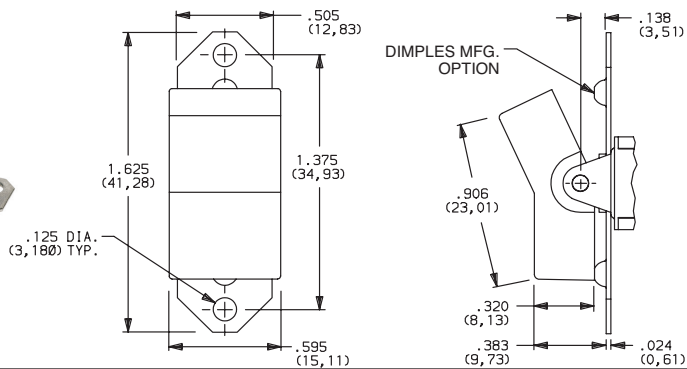

##### J3 Actuator

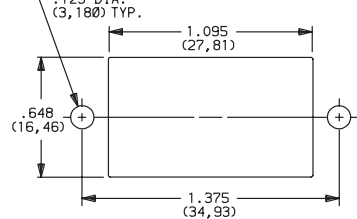

### J10 ROCKER

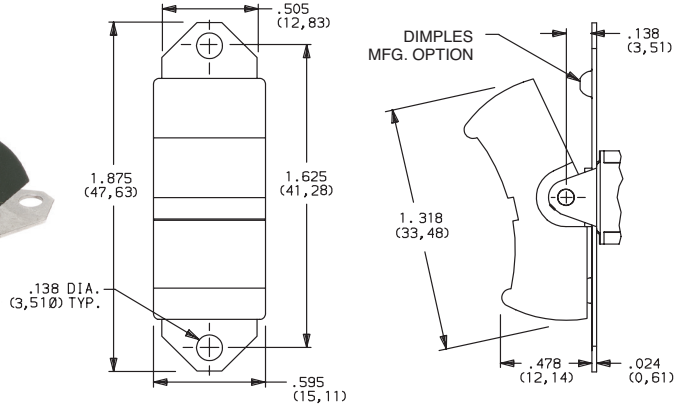

##### J10 Actuator

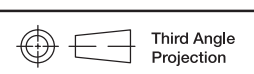
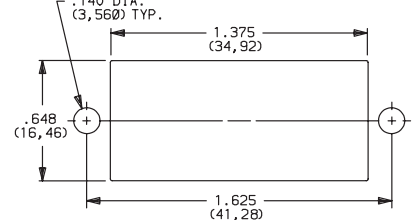

Dimensions are shown: Inches (mm)  
Specifications and dimensions subject to change



# 7000 Series Miniature Rocker & Lever Handle Switches

## ACTUATOR-SNAP-IN FRONT MOUNT

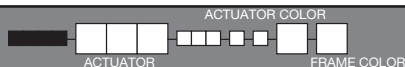

OPTION CODE	ACTUATOR COLOR
<b>2</b>	BLACK
<b>1</b>	WHITE
<b>3</b>	RED

OPTION CODE	FRAME COLOR
<b>2</b>	BLACK
<b>NONE</b>	No Frame Color (J15 or J25 options)
<b>1</b>	WHITE

Finish: Matte. Other colors, custom actuator markings and legends available, consult Customer Service Center.

**NOTE:** Actuators & frames available separately, see pages G-21 through G-22. J15, J16, J25, J26, J50 & J51 Actuators available with 71XX, 72XX, U1XX & U2XX models and C, W-W5, Z and Z3 terminations.

### PANEL MOUNTING

J15, J16, J25 & J26 Actuators

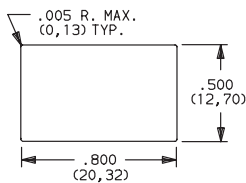

J50 Actuator

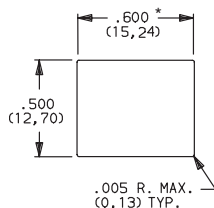

\* For J50: Increase this dimension to .620/.625 (15,75/15,88) for .091/.125 (2,31/3,18) thk. panels.

### J15 ROCKER, SNAP-IN

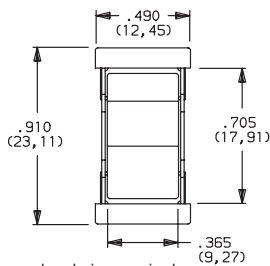

No frame color choice required

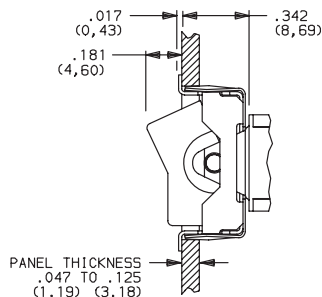

### J16 ROCKER WITH FRAME, SNAP-IN

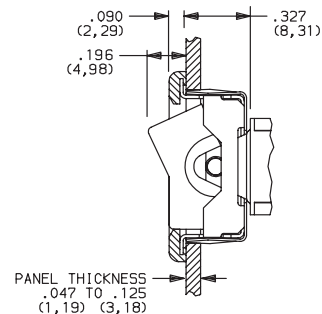
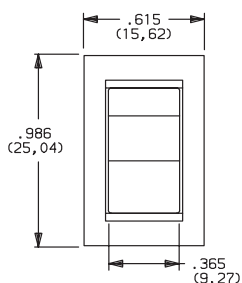

### J25 LEVER, SNAP-IN

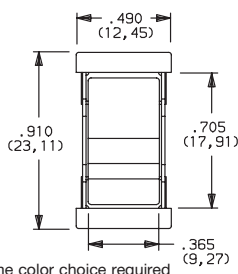

No frame color choice required

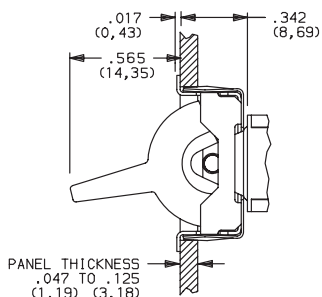

### J26 LEVER WITH FRAME, SNAP-IN

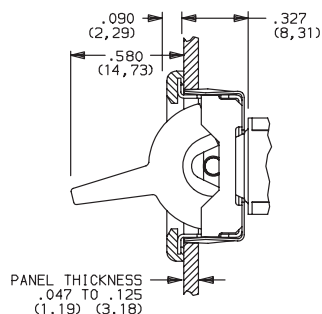
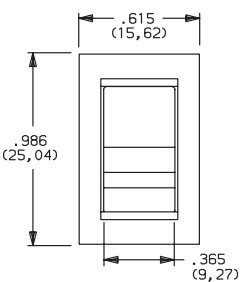

### J50 ROCKER, SNAP-IN

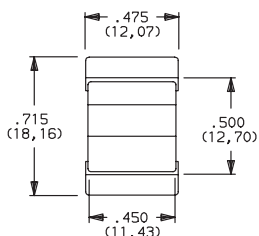

No frame color choice required

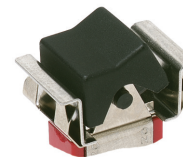
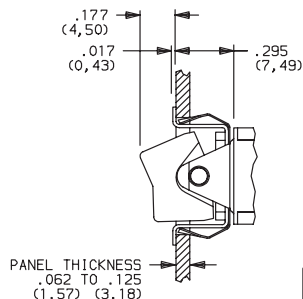

Dimensions are shown: Inches (mm)  
Specifications and dimensions subject to change



# 7000 Series Miniature Rocker & Lever Handle Switches

## ACTUATOR-SNAP-IN FRONT MOUNT



### J51 ROCKER WITH FRAME, SNAP-IN

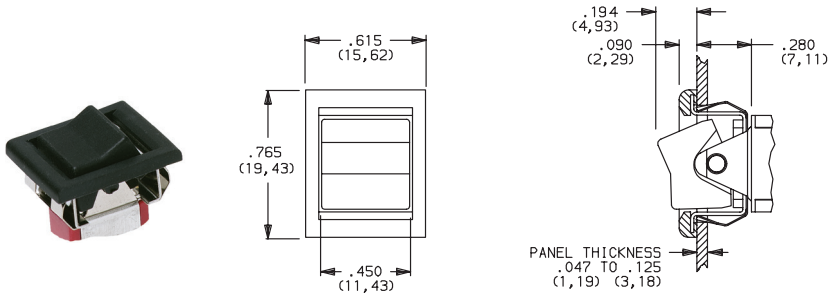

OPTION CODE	ACTUATOR COLOR
2	BLACK
1	WHITE
3	RED

### J52 ROCKER WITH FRAME FOR LED, SNAP-IN

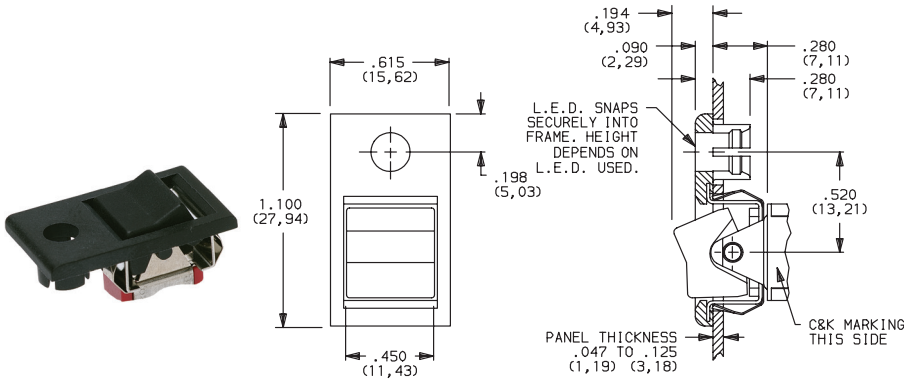

OPTION CODE	FRAME COLOR
2	BLACK
NONE	No Frame Color (J15 or J25 options)
1	WHITE

Finish: Matte. Other colors, custom actuator markings and legends available, consult Customer Service Center.

**NOTE:** Actuators & frames available separately, see pages G-21 through G-22. J51, J52, J60 & J61 Actuators available with 71XX, 72XX, U1XX & U2XX models and C, W-W5, Z and Z3 terminations.

LED not included.  
For LED information, see page G-24.

### J60 LEVER, SNAP-IN

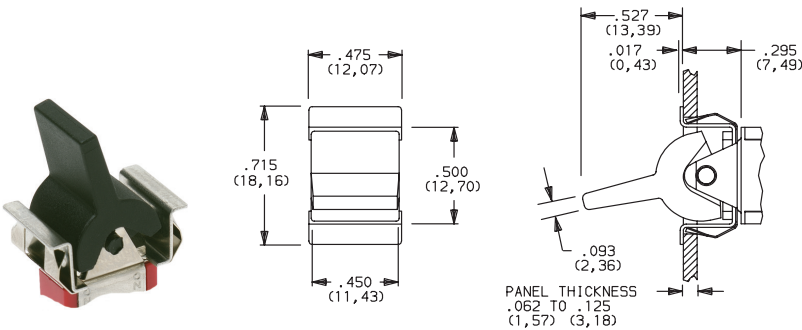

No frame color choice required

#### PANEL MOUNTING

J51, J60 & J61 Actuators

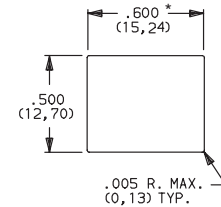

J52 Actuator

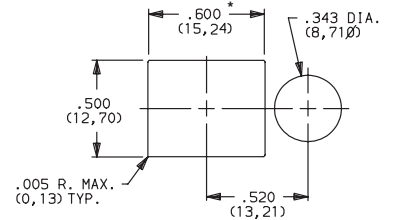

For J51, J52: Increase this dimension to .620/.625 (15,75/15,88) for .060/.125(1,52/3,18) thk. panels.

### J61 LEVER WITH FRAME, SNAP-IN

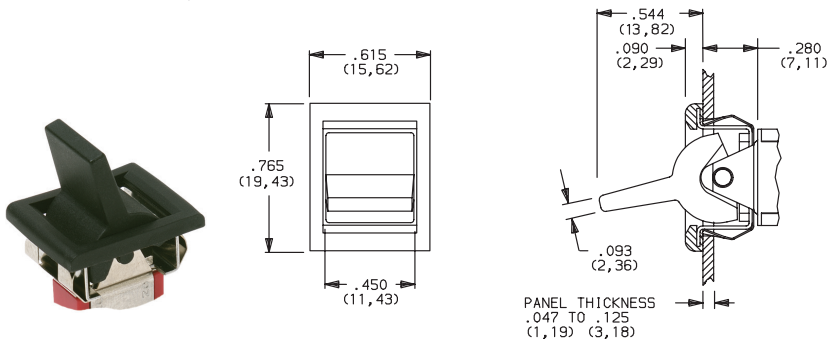

Dimensions are shown: Inches (mm)  
Specifications and dimensions subject to change



# 7000 Series Miniature Rocker & Lever Handle Switches

## ACTUATOR-SNAP-IN FRONT MOUNT

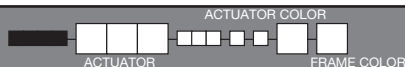

OPTION CODE	ACTUATOR COLOR
2	BLACK
1	WHITE
3	RED

OPTION CODE	FRAME COLOR
2	BLACK
NONE	No Frame Color (J90 options)
1	WHITE

Finish: Matte. Other colors, custom actuator markings and legends available, consult Customer Service Center.

**NOTE:** Actuators & frames available separately, see pages G-21 through G-22. J62, J90 & J91 Actuators available with 71XX, 72XX, U1XX & U2XX models and C, W-W5, Z & Z3 terminations.

### PANEL MOUNTING

J62 Actuator

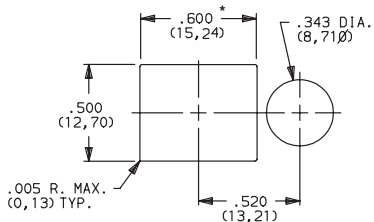

J90, J91 & J93 Actuators

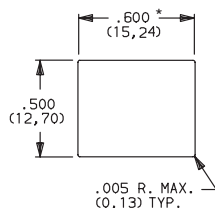

\* For J90: Increase this dimension to .620/.625 (15,75/15,88) for .091/.125 (2,31/3,18) thk. panels.  
For J91: Increase this dimension to .620/.625 (15,75/15,88) for .060/.125 (1,52/3,18) thk. panels.

### J62 LEVER WITH FRAME FOR LED, SNAP-IN

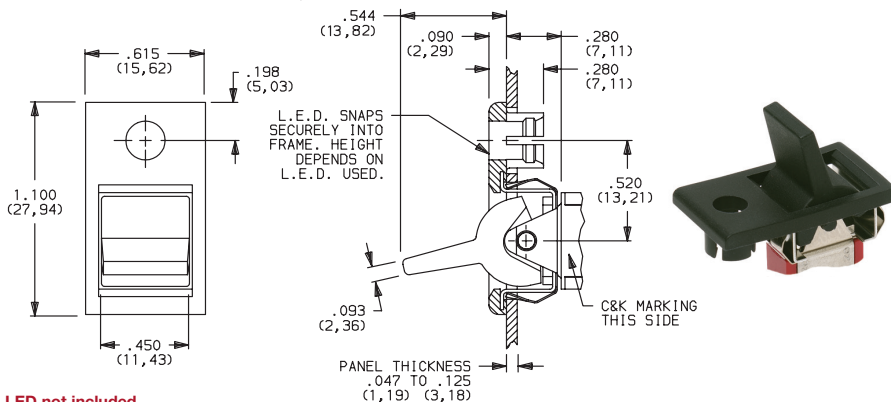

**LED not included.**  
For LED information, see page H-25.

### J90 LEVER, SNAP-IN

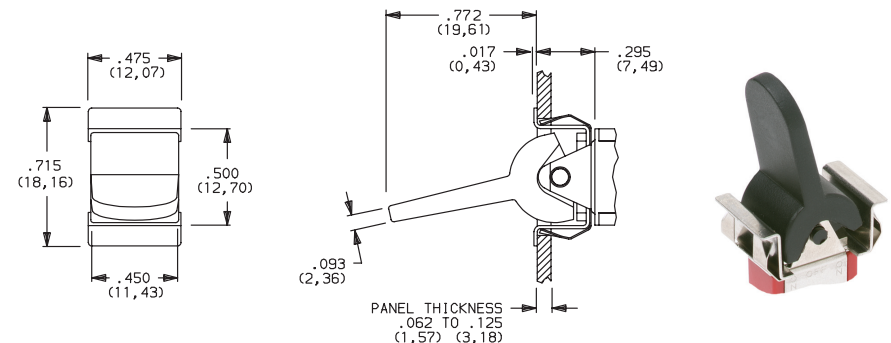

No frame color choice required.

### J91 LEVER WITH FRAME, SNAP-IN

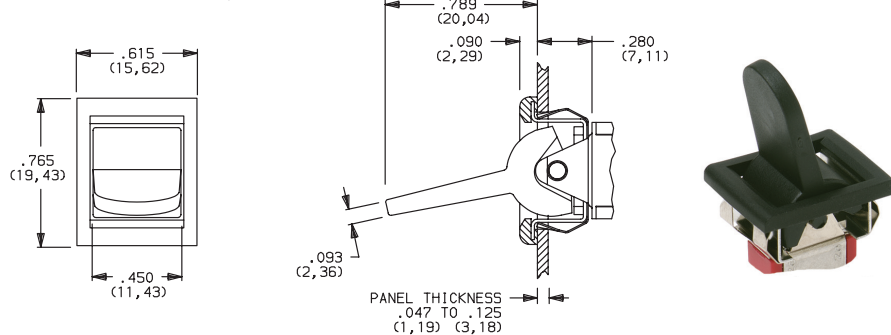

Rocker



Dimensions are shown: Inches (mm)

Specifications and dimensions subject to change



# 7000 Series Miniature Rocker & Lever Handle Switches

## ACTUATOR-REAR MOUNT

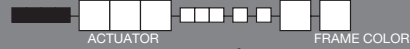

### J11 ROCKER WITH FRAME

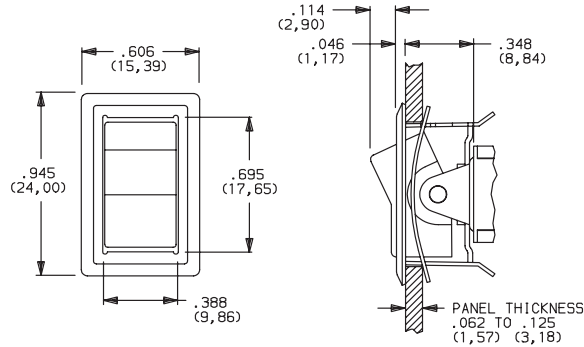

OPTION CODE	ACTUATOR COLOR
2	BLACK
1	WHITE
3	RED

OPTION CODE	FRAME COLOR
2	BLACK
1	WHITE

Actuator finish: Matte. Frame finish: Gloss. Other colors, custom actuator markings and legends available, consult Customer Service Center.

**NOTE:** Actuators & frames available separately, see pages G-21 through G-22. J11, J19, J21 & J37 Actuators available with C, W-W5, Z & Z3 terminations. J37 offered with Black Frame (2 color option) only.

### J19 ROCKER WITH FRAME

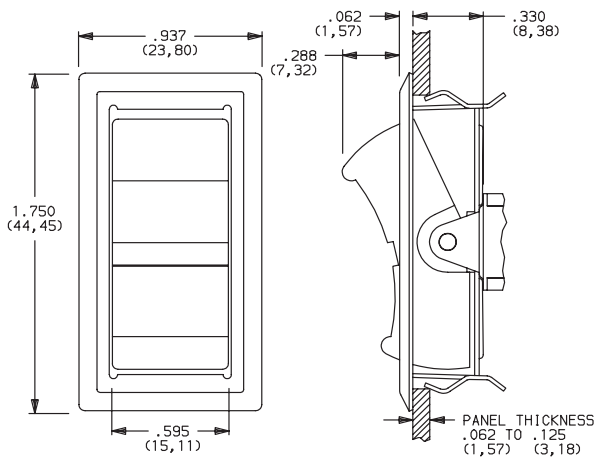

#### PANEL MOUNTING

##### J11 & J21 Actuators

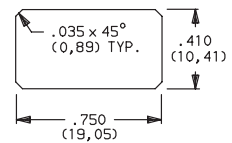

##### J19 Actuator

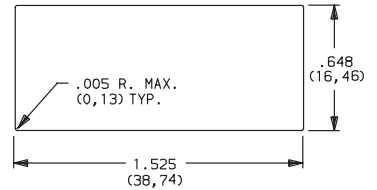

##### J37 Actuator

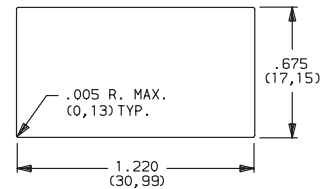

### J21 LEVER WITH FRAME

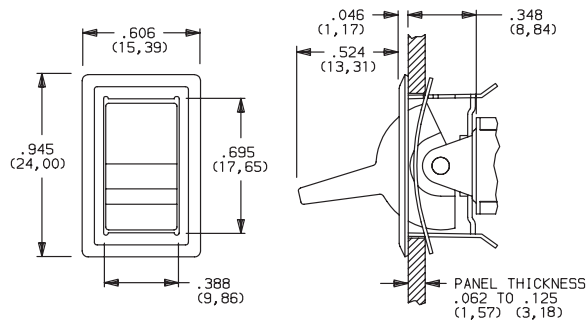

### J37 ROCKER WITH FRAME

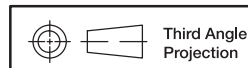
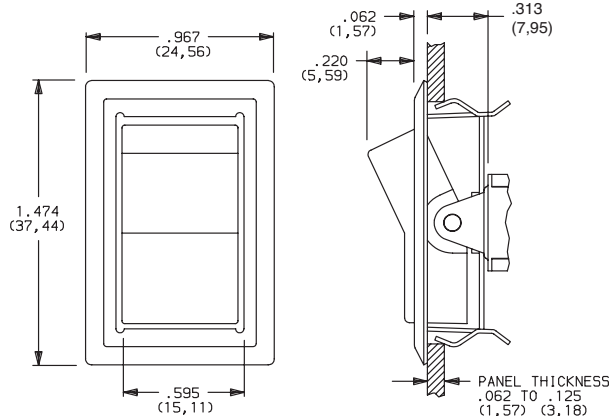

Dimensions are shown: Inches (mm)  
Specifications and dimensions subject to change

# 7000 Series Miniature Rocker & Lever Handle Switches

## ACTUATOR-PC MOUNT

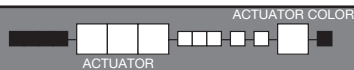

OPTION CODE	ACTUATOR COLOR
2	BLACK
1	WHITE
3	RED

Finish: Matte. Other colors, custom actuator markings and legends available, consult Customer Service Center.

**NOTE:** Some permissible actuator/termination combinations may lack clearance between actuator and PC board, and care must be exercised to accommodate this condition.

Actuators available separately, see page G-21 through G-22. J1, J2 actuators available with A, A3, AV2, AV3, AW3 & V2 terminations. J3 actuators available with AV2, AV3 & V2-V61 terminations. J50 actuators available with A (DP, 3P models only), A3 (DP, 3P models only), AV2, AV3, AW3 (DP, 3P models only) & V2-V61 terminations.

### J1 ROCKER

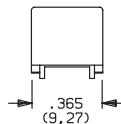
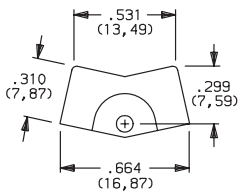

### J2 LEVER

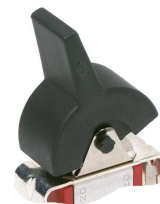
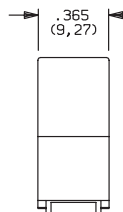
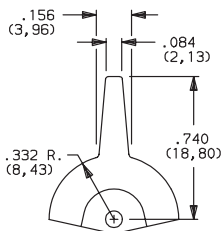

### J3 ROCKER

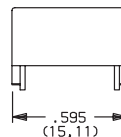
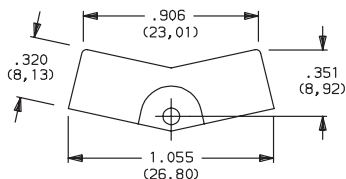

### J50 ROCKER

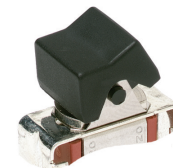
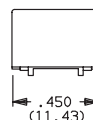
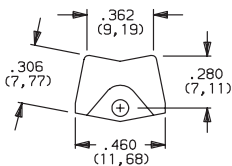

Rocker



Third Angle  
Projection

Dimensions are shown: Inches (mm)  
Specifications and dimensions subject to change

# 7000 Series Miniature Rocker & Lever Handle Switches

## ACTUATOR-PC MOUNT

ACTUATOR COLOR

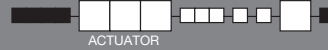

### J60 LEVER

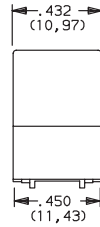
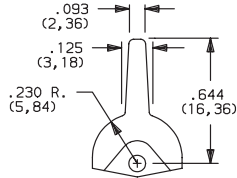

OPTION CODE	ACTUATOR COLOR
<b>2</b>	BLACK
<b>1</b>	WHITE
<b>3</b>	RED

Finish: Matte. Other colors, custom actuator markings and legends available, consult Customer Service Center.

**NOTE:** Some permissible actuator/termination combinations may lack clearance between actuator and PC board, and care must be exercised to accommodate this condition.

### J90 LEVER

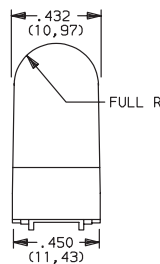
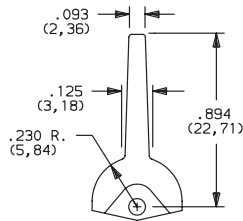

Actuators available separately, see page G-21 through G-22. J60 & J90 actuators available with A (DP, 3P models only), A3 (DP, 3P models only), AV2, AV3, AW3 (DP, 3P models only) & V2-V61 terminations.

## TERMINATIONS

### Z SOLDER LUG

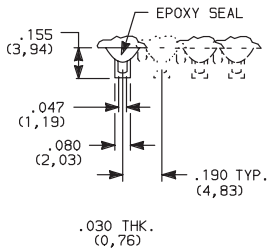

### SPDT thru 4PDT

Not available with P, R or S contact materials. Available actuators, see pages G-7 through G-13.

### C PC THRU-HOLE

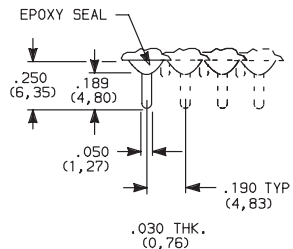

### SPDT thru 4PDT

**NOTE:** Available actuators, see pages G-7 through G-13.

### PC MOUNTING

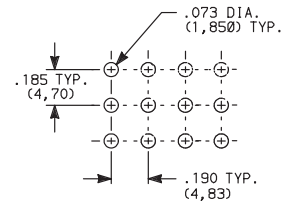

### Z3 QUICK CONNECT

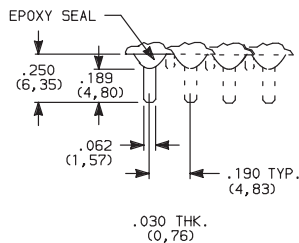

### SPDT thru 4PDT

Not available with P, R or S contact materials. Available actuators, see pages G-7 through G-13. Mating quick connector available; order part number 530100000, page G-22.

### W, W3, W5 WIRE WRAP

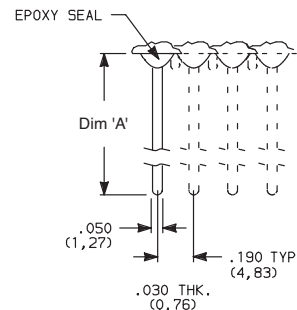

### SPDT thru 4PDT

**NOTE:** Available actuators, see pages G-7 through G-13.

OPTION CODE	DIM 'A'
<b>W</b>	.750 (19,05)
<b>W3</b>	.425 (10,80)
<b>W5</b>	1.305 (33,15)

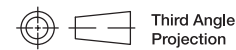

Third Angle Projection

Dimensions are shown: Inches (mm)  
Specifications and dimensions subject to change

# 7000 Series Miniature Rocker & Lever Handle Switches

## TERMINATIONS

### A RIGHT ANGLE, PC THRU-HOLE

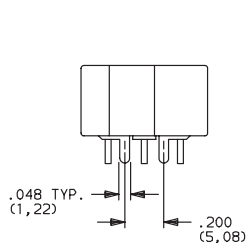

Actuator Shown In Pos. 1

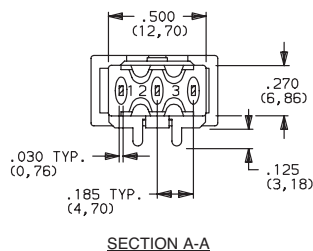
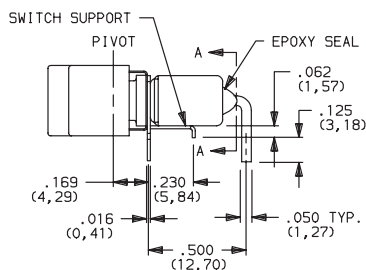

**7101J1ABE2**  
Horizontal Actuation  
**SPDT**

### A3 RIGHT ANGLE, SNAP-IN, PC THRU-HOLE

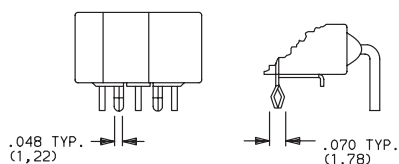

### AW3 RIGHT ANGLE, EXTENDED, PC THRU-HOLE

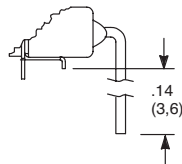

#### PC MOUNTING

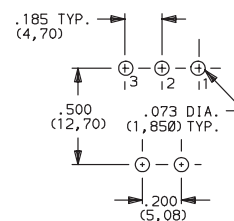

Not available with I seal option. Available actuators, see pages G-6 and G-12.  
Terminal bend radii and lead-in manufacturing option.

**NOTE:** PC pattern must clear switch support leg.

### A RIGHT ANGLE, PC THRU-HOLE

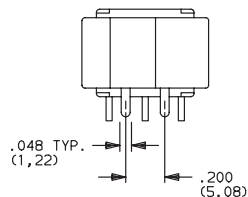

Actuator Shown In Pos. 1

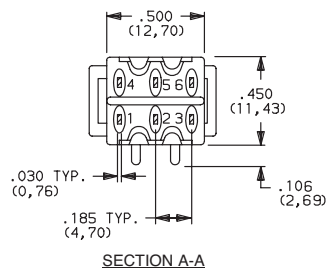
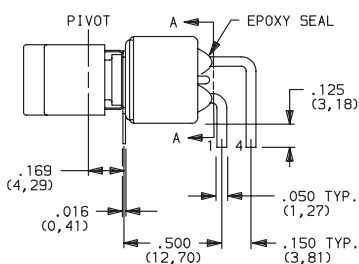

**7201J1ABE2**  
Horizontal Actuation  
**DPDT**

### A3 RIGHT ANGLE, SNAP-IN, PC THRU-HOLE

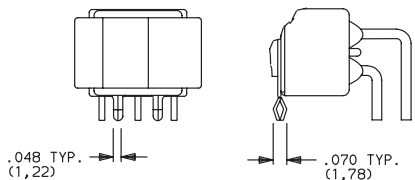

#### PC MOUNTING

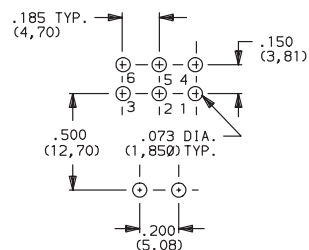

Not available with I seal option. Available actuators, see pages G-6 and G-12.  
Terminal bend radii and lead-in manufacturing option.

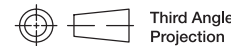

Third Angle Projection

Dimensions are shown: Inches (mm)  
Specifications and dimensions subject to change

Rocker

G

**C&K**

27 mar 17

# 7000 Series Miniature Rocker & Lever Handle Switches

## TERMINATIONS

### A RIGHT ANGLE, PC THRU-HOLE

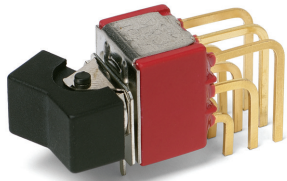

**7301J1ABE2**  
Horizontal Actuation  
**3PDT**

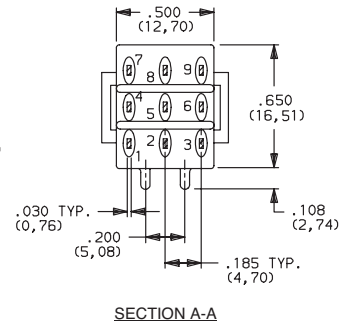
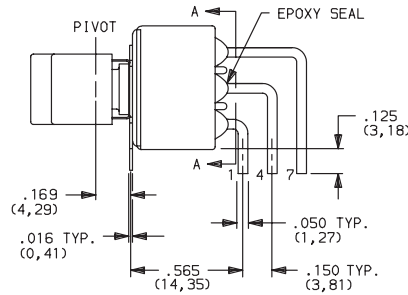
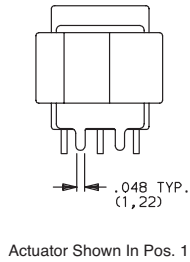

Not available with I seal option. Available actuators, see pages G-6 and G-12.  
Terminal bend radii and lead-in manufacturing option.

### PC MOUNTING

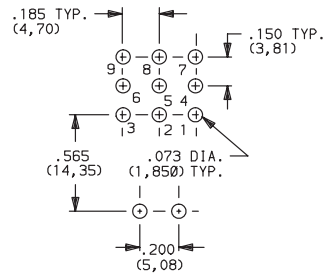

### AV2 VERTICAL RIGHT ANGLE, PC THRU-HOLE, .150" PITCH

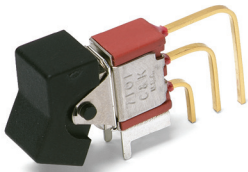

**7101J1AV2BE2**  
Vertical Actuation  
**SPDT**

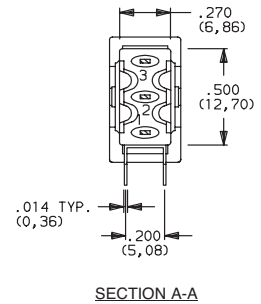
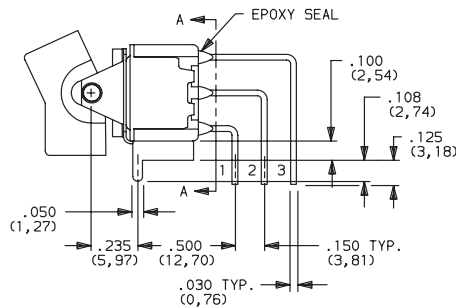
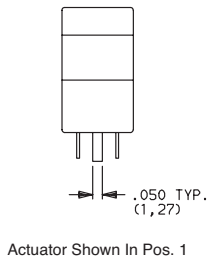

### AV3 VERTICAL RIGHT ANGLE, SNAP-IN, PC THRU-HOLE, .150" PITCH

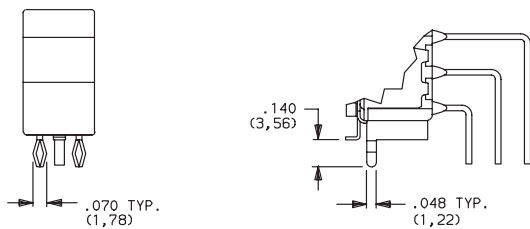

Not available with I seal option. Available actuators, see pages G-6 and G-12.  
Terminal bend radii and lead-in manufacturing option.

### PC MOUNTING

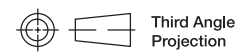
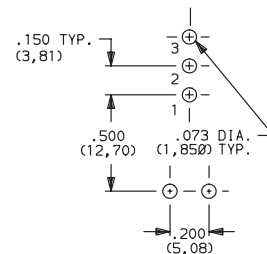

Dimensions are shown: Inches (mm)  
Specifications and dimensions subject to change



# 7000 Series Miniature Rocker & Lever Handle Switches

## TERMINATIONS

**AV2** VERTICAL RIGHT ANGLE, PC THRU-HOLE,  
.150" PITCH

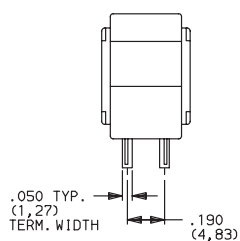

Actuator Shown In Pos. 1

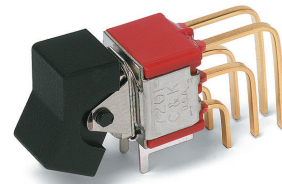
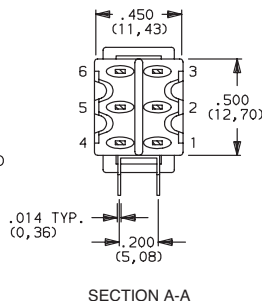
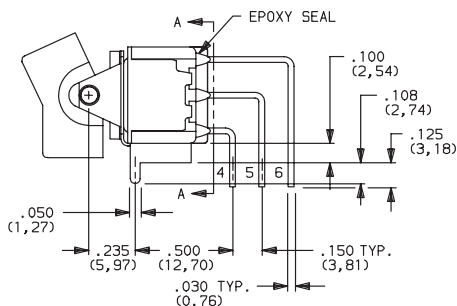

**7201J1AV2BE2**  
Vertical Actuation  
**DPDT**

**AV3** VERTICAL RIGHT ANGLE, SNAP-IN, PC THRU-HOLE,  
.150" PITCH

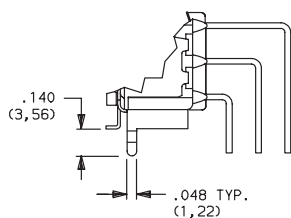
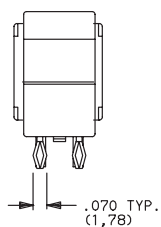

### PC MOUNTING

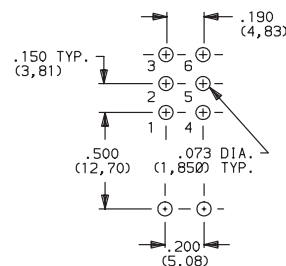

Not available with I seal option. Available actuators, see pages G-6 and G-12.  
Terminal bend radii and lead-in manufacturing option.

**AV2** VERTICAL RIGHT ANGLE, PC THRU-HOLE,  
.150" PITCH

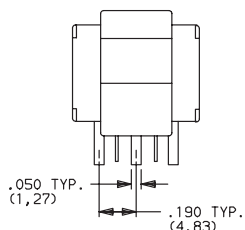

Actuator Shown In Pos. 1

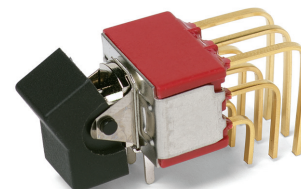
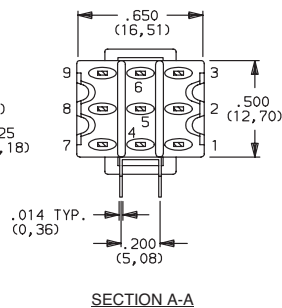
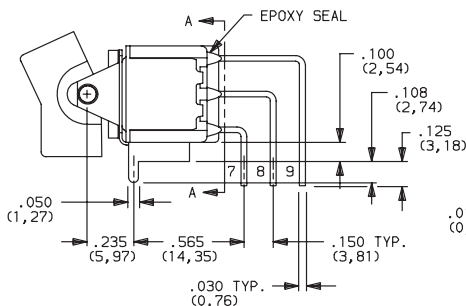

**7301J1AV2BE2**  
Vertical Actuation  
**3PDT**

**AV3** VERTICAL RIGHT ANGLE, SNAP-IN, PC THRU-HOLE,  
.150" PITCH

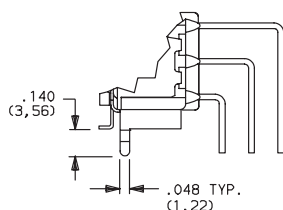
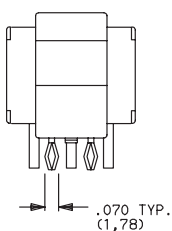

### PC MOUNTING

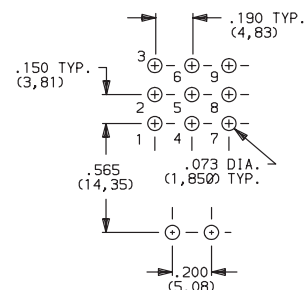

Not available with I seal option. Available actuators, see pages G-6 and G-12.  
Terminal bend radii and lead-in manufacturing option.



Dimensions are shown: Inches (mm)  
Specifications and dimensions subject to change

Rocker

**C&K**

27 mar 17



# 7000 Series Miniature Rocker & Lever Handle Switches

## TERMINATIONS

**AV2** VERTICAL RIGHT ANGLE, PC THRU-HOLE,  
.150" PITCH



**7401J1AV2BE2**  
Vertical Actuation  
**4PDT**

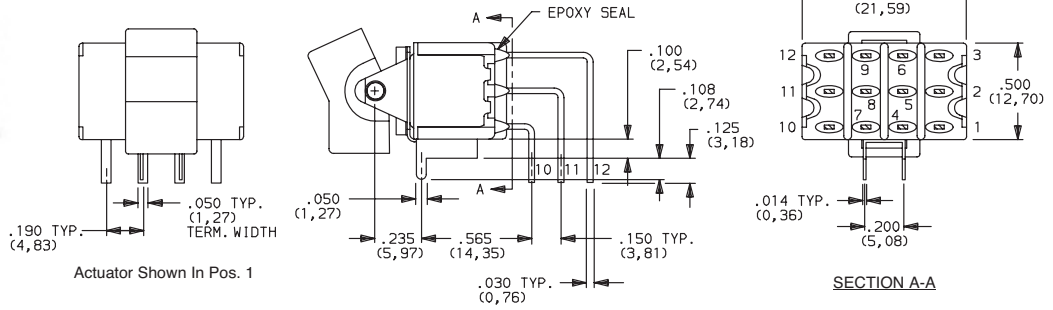

**AV3** VERTICAL RIGHT ANGLE, SNAP-IN, PC THRU-HOLE,  
.150" PITCH

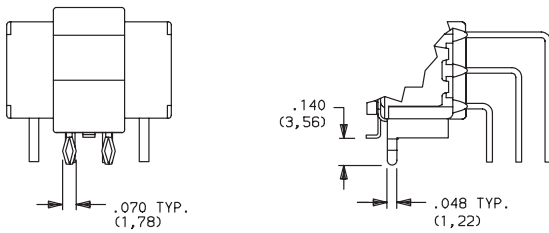

Not available with I seal option. Available actuators, see pages G-6 and G-12.  
Terminal bend radii and lead-in manufacturing option.

### PC MOUNTING

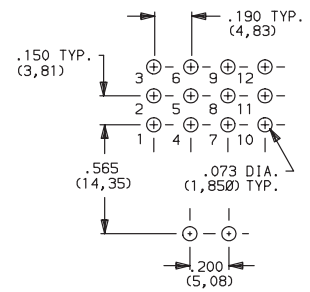

**V5** VERTICAL RIGHT ANGLE, PC THRU-HOLE,  
.150" PITCH

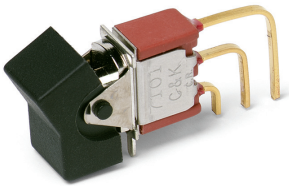

**7101J1V5BE2**  
Vertical Actuation  
**SPDT**

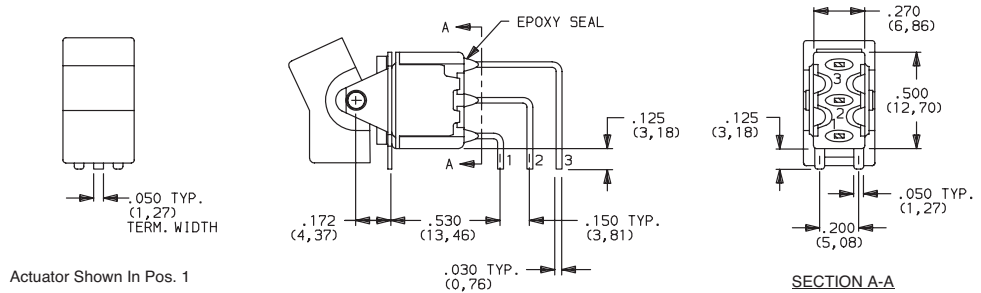

**V51** VERTICAL RIGHT ANGLE, SNAP-IN,  
PC THRU-HOLE, .150" PITCH

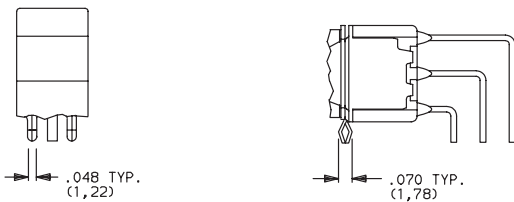

Not available with I seal option. Available actuators, see pages G-6 and G-12.  
Terminal bend radii and lead-in manufacturing option.

### PC MOUNTING

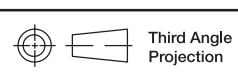
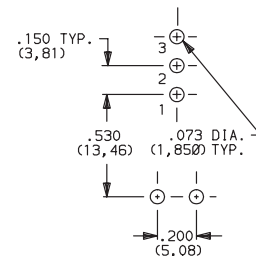

Dimensions are shown: Inches (mm)  
Specifications and dimensions subject to change



# 7000 Series Miniature Rocker & Lever Handle Switches

## TERMINATIONS

**V5** VERTICAL RIGHT ANGLE, PC THRU-HOLE,  
.150" PITCH

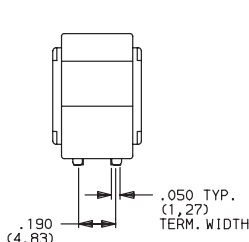

Actuator Shown In Pos. 1

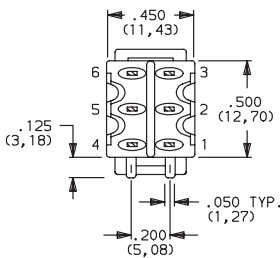
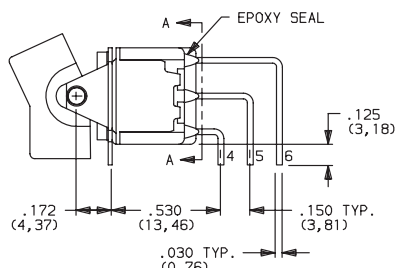

SECTION A-A



**7201J1V5BE2**  
Vertical Actuation  
DPDT

**V51** VERTICAL RIGHT ANGLE, SNAP-IN,  
PC THRU-HOLE, .150" PITCH

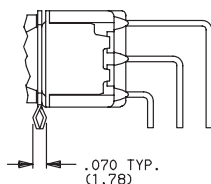
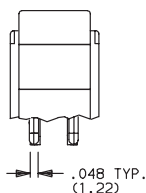

### PC MOUNTING

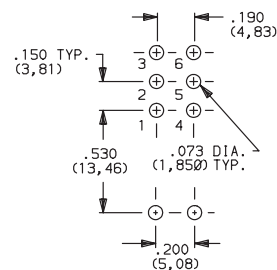

Not available with I seal option. Available actuators, see pages G-6 and G-12.  
Terminal bend radii and lead-in manufacturing option.

**V2, V6, V7, V8** VERTICAL MOUNT, V-BRACKET

**V61** VERTICAL MOUNT, V-BRACKET, SNAP-IN

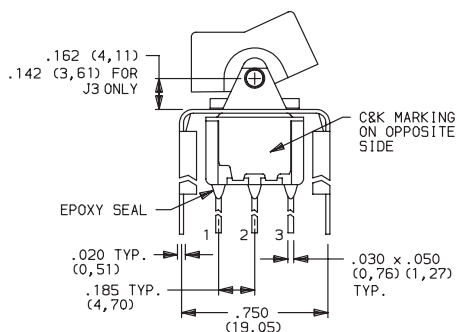

Actuator Shown In Pos. 1

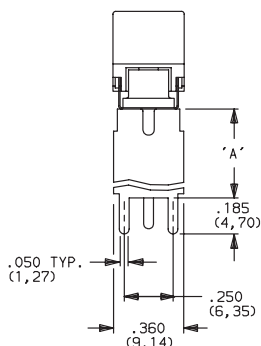

### PC MOUNTING

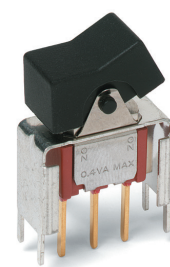
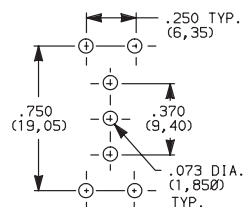

**7101J1\_BE2**  
SPDT

OPTION CODE	DIM 'A'
<b>V2, V21</b>	.555 (14,10)
<b>V6, V61</b>	.460 (11,68)
<b>V7</b>	.630 (16,00)
<b>V8</b>	.953 (24,21)



Dimensions are shown: Inches (mm)  
Specifications and dimensions subject to change

# 7000 Series Miniature Rocker & Lever Handle Switches

## TERMINATIONS

**V2, V6, V7, V8** VERTICAL MOUNT, V-BRACKET

**V21, V61** VERTICAL MOUNT, V-BRACKET, SNAP-IN



7201J1\_BE2  
DPDT

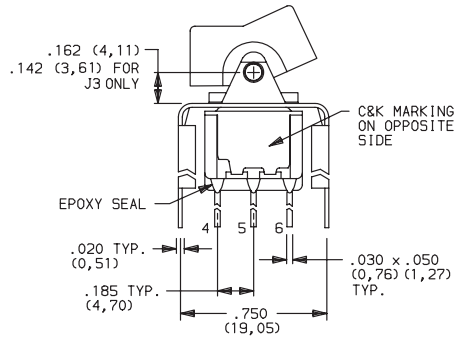

Actuator Shown In Pos. 1

### PC MOUNTING

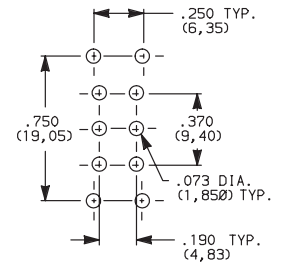

OPTION CODE	DIM 'A'
<b>V2, V21</b>	.555 (14,10)
<b>V6, V61</b>	.460 (11,68)
<b>V7</b>	.630 (16,00)
<b>V8</b>	.953 (24,21)

Not available with I seal option.  
Available actuators, see pages G-6 and G-12.

**V2, V7, V8** VERTICAL MOUNT, V-BRACKET

**V21** VERTICAL MOUNT, V-BRACKET, SNAP-IN



7301J1\_BE2  
3PDT

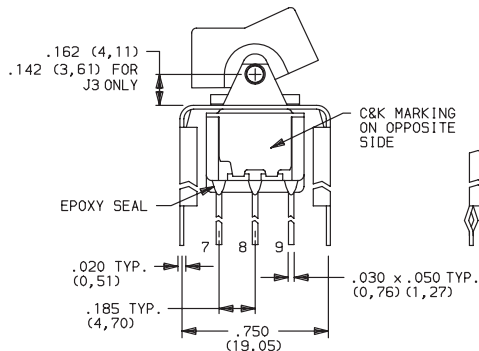

Actuator Shown In Pos. 1

### PC MOUNTING

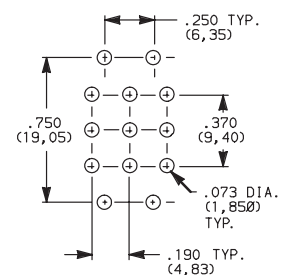

OPTION CODE	DIM 'A'
<b>V2, V21</b>	.555 (14,10)
<b>V7</b>	.630 (16,00)
<b>V8</b>	.953 (24,21)

Not available with I seal option.  
Available actuators, see pages G-6 and G-12.

**V2, V7, V8** VERTICAL MOUNT, V-BRACKET

**V21** VERTICAL MOUNT, V-BRACKET, SNAP-IN



7401J1\_BE2  
4PDT

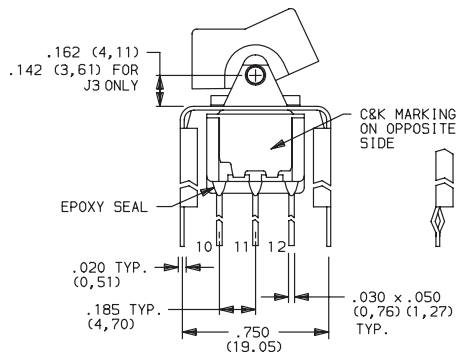

Actuator Shown In Pos. 1

### PC MOUNTING

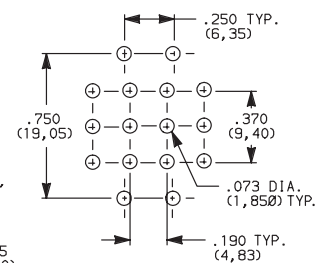

OPTION CODE	DIM 'A'
<b>V2, V21</b>	.555 (14,10)
<b>V7</b>	.630 (16,00)
<b>V8</b>	.953 (24,21)

Not available with I seal option.  
Available actuators, see pages G-6 and G-12.



Dimensions are shown: Inches (mm)  
Specifications and dimensions subject to change



# 7000 Series Miniature Rocker & Lever Handle Switches

## TERMINATIONS

**V3, V4, V9** VERTICAL MOUNT, V-BRACKET

**V31** VERTICAL MOUNT, V-BRACKET, SNAP-IN



7101J1\_BE2  
SPDT

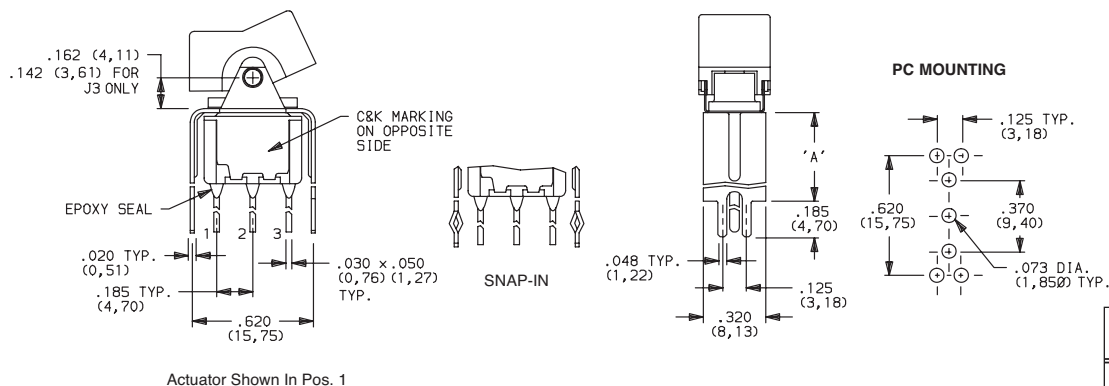

Not available with I seal option.  
Available actuators, see pages G-6 and G-12.

OPTION CODE	DIM 'A'
<b>V3, V31</b>	.460 (11,68)
<b>V4</b>	.630 (16,00)
<b>V9</b>	1.150 (29,21)

**V3, V4, V9** VERTICAL MOUNT, V-BRACKET

**V31** VERTICAL MOUNT, V-BRACKET, SNAP-IN

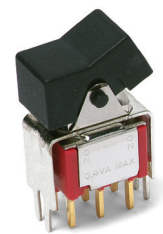

7201J1\_BE2  
DPDT

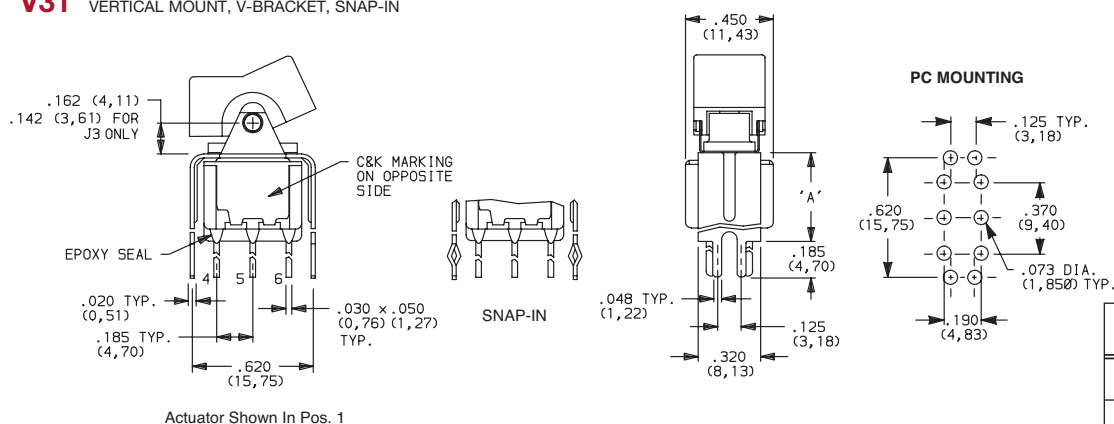

Not available with I seal option.  
Available actuators, see pages G-6 and G-12.

OPTION CODE	DIM 'A'
<b>V3, V31</b>	.460 (11,68)
<b>V4</b>	.630 (16,00)
<b>V9</b>	1.150 (29,21)

**V4, V9** VERTICAL MOUNT, V-BRACKET



7301J1\_BE2  
3PDT

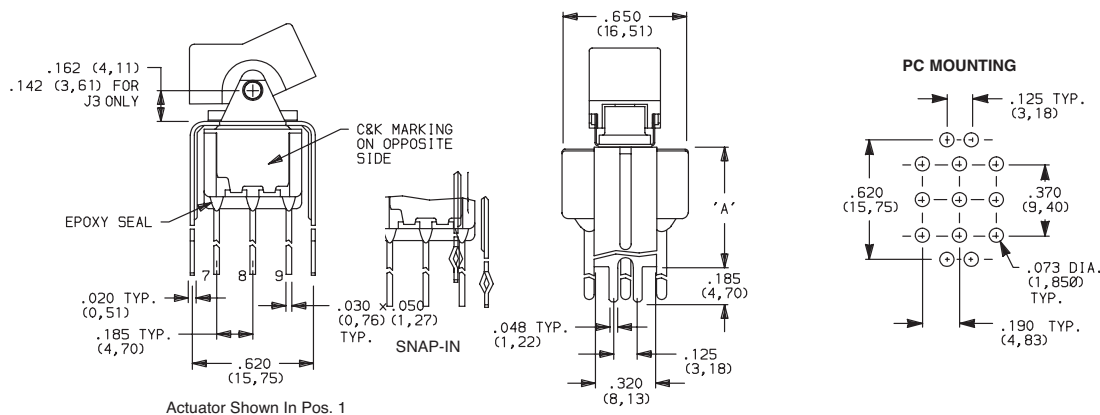

Not available with I seal option.  
Available actuators, see pages G-6 and G-12.

OPTION CODE	DIM 'A'
<b>V4</b>	.630 (16,00)
<b>V9</b>	1.150 (29,21)



Dimensions are shown: Inches (mm)  
Specifications and dimensions subject to change

Rocker



# 7000 Series Miniature Rocker & Lever Handle Switches

## TERMINATIONS

**V4, V9** VERTICAL MOUNT, V-BRACKET



7401J1\_BE2  
4PDT

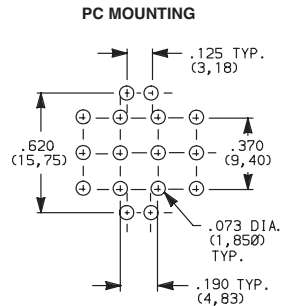
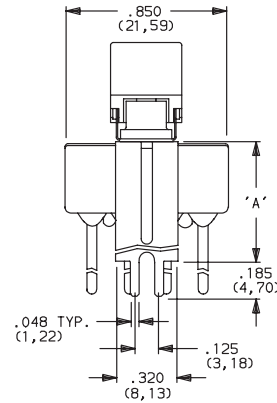
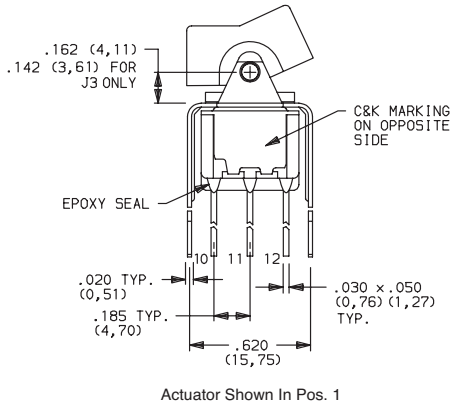

OPTION CODE	DIM 'A'
<b>V4</b>	.630 (16,00)
<b>V9</b>	1.150 (29,21)

Not available with I seal option.  
Available actuators, see pages G-6 and G-12.

## CONTACT MATERIAL

OPTION CODE	CONTACT MATERIAL	TERMINAL PLATING	RATINGS	
<b>B</b>	GOLD <sup>1</sup>	GOLD <sup>1</sup>	LOW LEVEL/ DRY CIRCUIT	0.4 VA MAX. @ 20 V AC OR DC MAX.
<b>P</b>		MATTE-TIN <sup>6</sup>		
<b>Q</b>	SILVER <sup>4,5</sup>	SILVER <sup>5</sup>	POWER	5 AMPS @ 120 V AC OR 28 V DC; 2 AMPS @ 250 V AC.
<b>S</b>		MATTE-TIN <sup>6</sup>		
<b>G</b>	GOLD OVER SILVER <sup>2,3</sup>	GOLD <sup>3</sup>	LOW LEVEL/DRY CIRCUIT OR POWER	0.4 VA MAX @ 20 V AC OR DC MAX OR 5 AMPS @ 120 V AC OR 28 V DC; 2 AMPS @ 250 V AC.
<b>R</b>		MATTE-TIN <sup>6</sup>		

\* Note: See Technical Data section of this catalog for RoHS compliant and compatible definitions and specifications.

- <sup>1</sup> CONTACTS & TERMINALS: Copper alloy, with gold plate over nickel plate.
- <sup>2</sup> END CONTACTS: Coin silver, with gold plate over nickel plate.
- <sup>3</sup> CENTER CONTACTS & ALL TERMINALS: Copper alloy, with gold plate over nickel plate.
- <sup>4</sup> END CONTACTS: Coin silver, silver plated.
- <sup>5</sup> CENTER CONTACT & ALL TERMINALS: Copper alloy, silver plated.
- <sup>6</sup> TERMINALS: Copper alloy, with matte-tin over nickel plate.

U11-U415 model numbers **C&K** **US** with all options when ordered with G, Q, S & R contact material.

B contact material standard with all terminations except C, Z & Z3.  
Q contact material standard with C, Z & Z3 terminations.

**P, S & R, contact materials not available with Z & Z3 terminations.**

**NOTE: Any models supplied with Q, B, G S, P & R contact material are RoHS compliant.**

## SEAL

**E** EPOXY SEAL

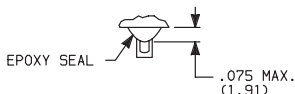

**I** EPOXY POTTED BASE

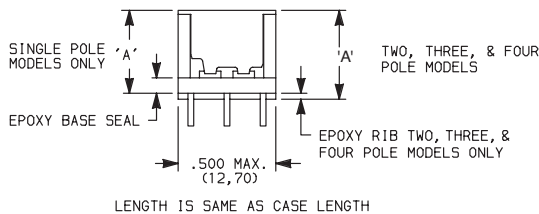

Available with C, W through W5, Z & Z3 terminations.

NO. POLES	DIM 'A'
SP	.410 (10,41)
DP	.440 (11,18)
3P	.505 (12,83)
4P	.505 (12,83)

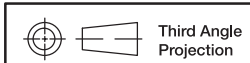

Dimensions are shown: Inches (mm)  
Specifications and dimensions subject to change



# 7000 Series Miniature Rocker & Lever Handle Switches

## AVAILABLE HARDWARE

Panel mounting hardware for rocker and lever handle switches is available separately. Mounting hardware consists of two screws, two nuts, two standoffs and two lockwashers per switch, and is available for panel thicknesses of 1/16, 3/32 and 1/8 inch. See part numbers below.

Qty	Part Number	Description
2	761103000	Standoffs
2	764100000	Mounting screws
2	764200000	Lock washers
2	764300000	Hex nuts

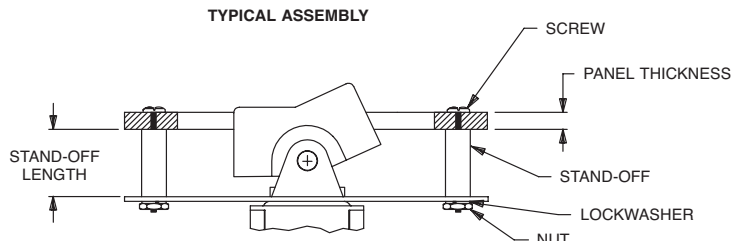

### J1 & J2 actuators

PART NO.	PANEL THK.	STANDOFF LENGTH
761103000	1/8 IN. (3,18)	.233 (5,92)

### J3 actuators

PART NO.	PANEL THK.	STANDOFF LENGTH
770603000	1/8 IN. (3,18)	.233 (5,92)

### J10 actuators

PART NO.	PANEL THK.	STANDOFF LENGTH
770703000	1/8 IN. (3,18)	.233 (5,92)

### MATERIAL

Screws, nuts, lockwashers: Stainless steel. Standoffs: Nylon, standard.

### J1, J11, J15 & J16 Actuators



PART NO.  
776A01000 WHITE  
776A02263 BLACK  
776A03000 RED

Material: Nylon  
Finish: Matte

### J2, J21, J25 & J26 Actuators



PART NO.  
426D01000 WHITE  
426D02263 BLACK  
426D03000 RED

Material: Nylon  
Finish: Matte

### J3 & J37 Actuators



PART NO.  
431D01000 WHITE  
431D02263 BLACK  
431D03000 RED

Material: Nylon  
Finish: Matte

### J50, J51 & J52 Actuators

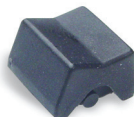

PART NO.  
775A01000 WHITE  
775A02263 BLACK  
775A03000 RED

Material: Nylon  
Finish: Matte

### J60, J61 & J62 Actuators



PART NO.  
598101000 WHITE  
613802263 BLACK  
598103000 RED

Material: Nylon  
Finish: Matte

# 7000 Series Miniature Rocker & Lever Handle Switches

## AVAILABLE HARDWARE

J90 & J91 Actuators



PART NO.  
**598001000** WHITE  
**598002263** BLACK  
**598003000** RED

Material: Nylon  
 Finish: Matte

J10 & J19 Actuators



PART NO.  
**769501000** WHITE  
**769502263** BLACK  
**769503000** RED

Material: Nylon  
 Finish: Matte

Fits Z3 Termination female connector



PART NO.  
**530100000**

Available in loose pieces.

Frame for J11 & J21 Actuators



PART NO.  
**764500746** BLACK ENAMEL  
**764500747** WHITE ENAMEL  
**764601106** RETAINING SPRING

Material: Spring Steel

Frame for J16 & J26 Actuators



PART NO.  
**459101000** WHITE  
**459102000** BLACK  
**459103000** RED

Material: Nylon  
 Finish: Matte

Frame for J51, J61 & J91 Actuators



PART NO.  
**615601000** WHITE  
**615602263** BLACK  
**615603000** RED

Material: Nylon  
 Finish: Matte

Frame for J19 Actuator



PART NO.  
**781000746** BLACK ENAMEL  
**781000747** WHITE ENAMEL

Material: Spring Steel

Frame for J37 Actuator



PART NO.  
**445400746** BLACK ENAMEL

Material: Spring Steel

Frame for J52 & J62 Actuators

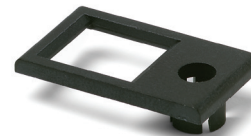

PART NO.  
**613301000** WHITE  
**613302263** BLACK  
**613303000** RED

Material: Nylon  
 Finish: Matte

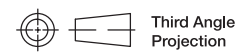

Dimensions are shown: Inches (mm)  
 Specifications and dimensions subject to change



# 7000 Series Miniature Rocker & Lever Handle Switches

## AVAILABLE HARDWARE

Frames snap into panel opening and are independent from switch mounting. Accurate positioning of the PC mounted switch relative to the panel opening is necessary to provide proper clearance between actuator and frame. Available in two basic styles and four panel thicknesses .047-.125 in. Material: Nylon. Finish: Matte.

TYPICAL APPLICATION

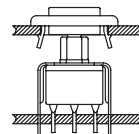

### J1 & J2 Actuators

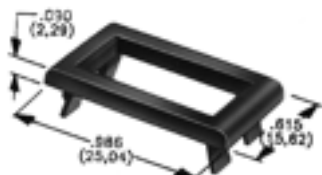

.047" (1,19) PANEL THK.    .062" (1,57) PANEL THK.    .090" (2,29) PANEL THK.    .125" (3,18) PANEL THK.

PART NO.                      PART NO.                      PART NO.                      PART NO.  
**452902263**                      **452702263**                      **452802263**                      **452602263** BLACK

### J50, J60 & J90 Actuators

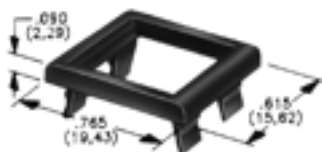

.047" (1,19) PANEL THK.    .062" (1,57) PANEL THK.    .090" (2,29) PANEL THK.    .125" (3,18) PANEL THK.

PART NO.                      PART NO.                      PART NO.                      PART NO.  
**432502263**                      **432602263**                      **432702263**                      **432802263** BLACK

### PANEL MOUNTING

For part numbers  
 4529xxxxx, 4527xxxxx,  
 4528xxxxx, 4526xxxxx

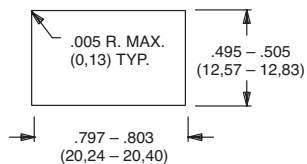

For part numbers  
 4325xxxxx, 4326xxxxx

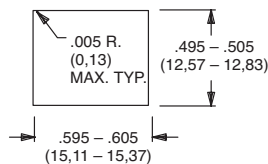

For part numbers  
 4327xxxxx, 4328xxxxx

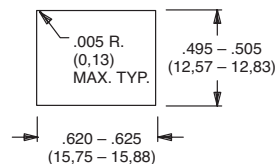

Rocker



G

**C&K**

27 mar 17

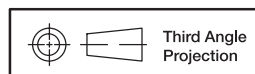

Dimensions are shown: Inches (mm)  
 Specifications and dimensions subject to change



# 7000 Series Miniature Rocker & Lever Handle Switches

## AVAILABLE HARDWARE

### Panel Inserts

Will fit Separate Snap-in frames for J50, J60 & J90 actuators

Above frames (part nos. 432XXXXXX) are also available with insert which accepts LED for indicator light assembly. Order insert separately from frame. Blank insert panel (without hole for LED) also available. **LED not included.**

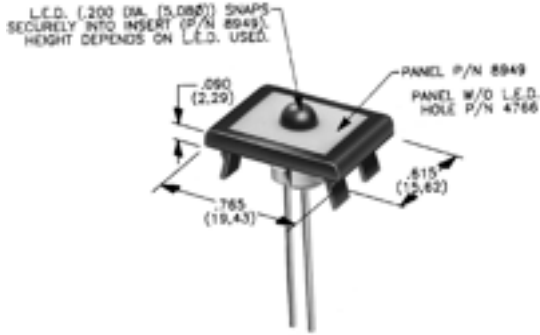

PANEL INSERT  
WITH HOLE FOR LED

PART NO.  
**894902000**

BLANK PANEL INSERT  
WITHOUT HOLE FOR LED

PART NO.  
**476602000** BLACK

NOTE: Special colors, custom markings available, consult Customer Service Center.

### LED INFORMATION

**Process Information:** Soldering to LED leads must be completed within 5 seconds at 500° F (260°C) maximum.

LEDs are not supplied with J52, J62 options. LED snaps into switch frame surrounding actuator and is wired externally.

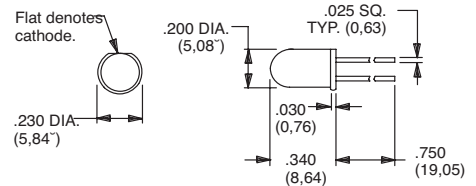

Suggested LED for J52 & J62 options.  
Dimensions for reference only.

# E Series

## Sealed Miniature Rocker and Lever Handle Switches

### Features/Benefits

- Sealed against solder and cleaning process contaminants
- ESD Resistance—all actuator options
- Rocker, case & bushing UL 94V-0
- RoHS compliant

### Typical Applications

- Telecommunications
- Instrumentation
- Computers & peripherals

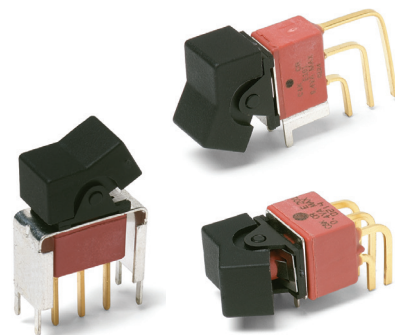

### Specifications

**CONTACT RATING:** B contact material: 0.4 VA max. @ 20 V AC or DC max. Q contact material (E1XX & E2XX Models): 7.5 AMPS @ 125 V AC or 28 V DC; 3 AMPS @ 250 V AC. (E3XX Models): 5 AMPS @ 125 V AC or 28 V DC; 2 AMPS @ 250 V AC. See page G-36 for additional ratings.

**ELECTRICAL LIFE:** E1XX and E2XX models: 40,000 make-and-break cycles at full load. E3XX models: 30,000 cycles.

**CONTACT RESISTANCE:** Below 10 m Ω typ. initial @ 2-4 V DC, 100 mA, for both silver and gold plated contacts.

**INSULATION RESISTANCE:** 10<sup>9</sup> Ω min.

**ELECTROSTATIC DISCHARGE (ESD) OPTION:** All actuator options: 15,000 V DC max. @ sea level, actuator to terminals.

**DIELECTRIC STRENGTH:** 1000 Vrms min. @ sea level.

**OPERATING TEMPERATURE:** -30°C to 85°C.

**SOLDERABILITY:** Per MIL-STD-202F method 208D, or EIA RS-186E method 9 (1 hour steam aging).

### Materials

**CASE & BUSHING:** Glass filled nylon 6/6, flame retardant, heat stabilized (UL 94V-0).

**ACTUATOR:** Nylon, black standard, internal o-ring seal standard with all actuators.

**FRAME:** Spring steel, black standard.

**SWITCH SUPPORT:** Brass or steel, matte-tin plated.

**ACTUATOR PIVOT & MOUNTING BRACKET:** Nylon.

**ACTUATOR PIVOT RETAINER:** Stainless steel.

**CONTACTS & TERMINALS:** B contact material: Copper alloy, with gold plate over nickel plate. Q contact material: Copper alloy, silver plated. See page G-36 for additional contact materials.

**TERMINAL SEAL:** Epoxy.

**HARDWARE:** Nut, Screw & Lockwasher: Stainless steel. Standoff: Nylon standard, aluminum available, consult Customer Service Center.

**NOTE:** Any models supplied with Q, B, G, S, P & R contact material are RoHS compliant.

**NOTE:** Specifications and materials listed above are for switches with standard options. For information on specific and custom switches, consult Customer Service Center.

### Build-A-Switch

To order, simply select desired option from each category and place in the appropriate box. Available options are shown and described on pages G-26 through G-38. For additional options not shown in catalog, consult Customer Service Center. All models are process sealed to withstand machine soldering temperatures and pressure wash cleaning methods.

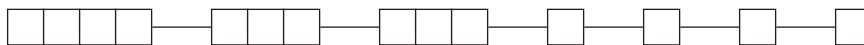

#### Switch Function

- E101** SP On-None-On
- E103** SP On-Off-On
- E105** SP Mom.-Off-Mom.
- E107** SP On-Off-Mom.
- E108** SP On-None-Mom.
- E201** DP On-None-On
- E203** DP On-Off-On
- E205** DP Mom.-Off-Mom.
- E207** DP On-Off-Mom.
- E208** DP On-None-Mom.
- E211** DP On-On-On
- E213** DP On-On-Mom.
- E215** DP Mom.-On-Mom.
- E301** 3P On-None-On

#### Actuator

- J1** .531" long rocker
- J2** Lever
- J3** .906" long rocker
- J11** Rocker with frame
- J21** Lever with frame
- J50** .362" long rocker
- J60** Lever
- J90** Lever

#### Terminations

- A** Right angle, PC thru-hole
- AV2** Vertical right angle, PC thru-hole
- C** PC Thru-hole
- Z** Solder lug
- A3** Right angle, snap-in, PC thru-hole
- AV3** Vertical right angle, snap-in, PC thru-hole
- V3** .460" high, V-bracket
- V4** .630" high, V-bracket
- V5** Vertical right angle, PC thru-hole
- V6** .460" high, V-bracket
- V7** .630" high, V-bracket
- V8** .953" high, V-bracket
- V21** .555" high, V-bracket, snap-in
- V31** .460" high, V-bracket, snap-in

#### Contact Material

- B** Gold
- P** Gold, matte tin
- Q** Silver
- S** Silver, matte-tin
- G** Gold over silver
- R** Gold over silver, matte-tin

#### Seal

- E** Epoxy

#### Actuator Color

- 2** Black
- 3** Red

#### Frame Color

- 2** Black
- NONE** No frame color required

#### Metal Frame Color

- (J11, J21 Actuators)
- 2** Black

Rocker



G



*Dimensions are shown: Inches (mm)  
Specifications and dimensions subject to change*

# E Series Sealed Miniature Rocker and Lever Handle Switches

## SWITCH FUNCTION



NO. POLES	MODEL NO.	SWITCH FUNCTION			CONNECTED TERMINALS			SCHEMATIC
		POS. 1	POS. 2	POS. 3	POS. 1	POS. 2	POS. 3	
		C&K marking on opposite side			C&K marking on opposite side			
SP	<b>E101</b>	ON	NONE	ON	2-3	N/A	2-1	
	<b>E103</b>	ON	OFF	ON				
	<b>E105</b>	MOM.	OFF	MOM.		OPEN		
	<b>E107</b>	ON	OFF	MOM.				
	<b>E108</b>	ON	NONE	MOM.		N/A		
							SPDT	

### SPDT

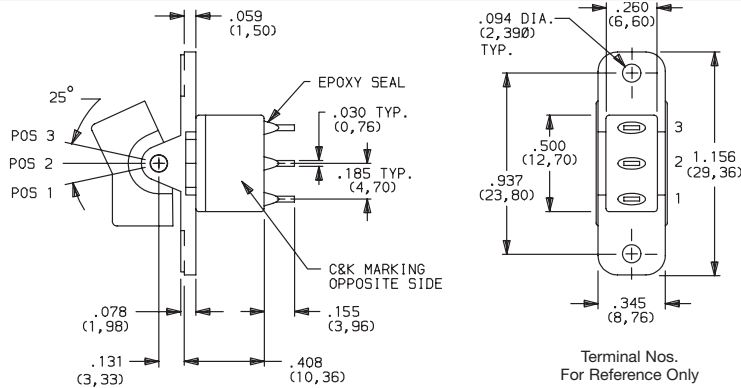

Part number shown: E101J1ZBE2

DP	<b>E201</b>	ON	NONE	ON	2-3,5-6	N/A	2-1,5-4	
	<b>E203</b>	ON	OFF	ON				
	<b>E205</b>	MOM.	OFF	MOM.		OPEN		
	<b>E207</b>	ON	OFF	MOM.				
	<b>E208</b>	ON	NONE	MOM.				
	<b>E211**</b>	ON	ON	ON				
	<b>E213**</b>	ON	ON	MOM.		2-3,5-4		
	<b>E215**</b>	MOM.	ON	MOM.				
							DPDT	

### DPDT

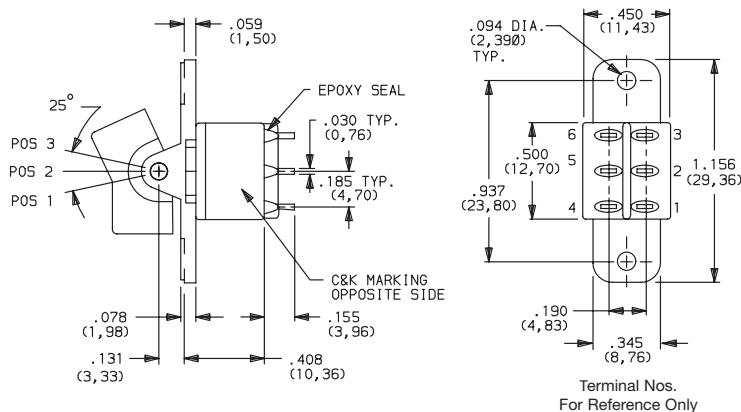

Part number shown: E201J1ZBE2

MOM. = Momentary

\*\* Wiring for 3-way switch, Hardware available separately, see Technical Data section of this catalog.

All models with all options when ordered with G, Q, R or S contact material.

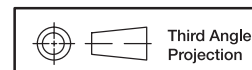

Dimensions are shown: Inches (mm)  
Specifications and dimensions subject to change

**C&K**



# E Series Sealed Miniature Rocker and Lever Handle Switches

## SWITCH FUNCTION

NO. POLES	MODEL NO.	SWITCH FUNCTION			CONNECTED TERMINALS			SCHEMATIC
		POS. 1	POS. 2	POS. 3	POS. 1	POS. 2	POS. 3	
		C&K marking on opposite side			C&K marking on opposite side			
3P	<b>E301</b>	ON	NONE	ON	2-3-5-6-8-9	N/A	2-1-5-4-8-7	<p style="text-align: center;">3PDT</p>
<b>3PDT</b>								Terminal Nos. For Reference Only
Part number shown: E301J1ZBE2								

MOM. = Momentary

\*\* Wiring for 3-way switch, see Technical Data section of this catalog.

All models with all options when ordered with G, Q, R and S contact material.

## ACTUATOR-PANEL REAR MOUNT

OPTION CODE	ACTUATOR COLOR
<b>2</b>	<b>BLACK</b>
<b>3</b>	<b>RED</b>

Finish: Matte. Other colors, custom actuator markings and legends available, consult Customer Service Center.

**NOTE:** Hardware: two each—mounting screws, nuts, lockwashers and standoffs for 1/8 inch thick panel are supplied standard on switches with panel mounting bracket. Internal o-ring actuator seal standard. Actuators available separately, see page G-36. Hardware available separately, see Technical Data section of this catalog. J1, J2 actuators available with C, Z or Z3 terminations.

### J1 LEVER

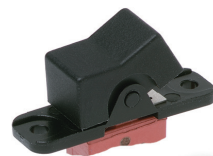
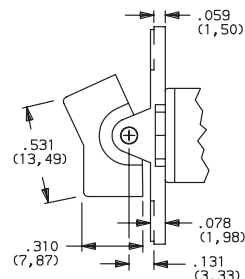
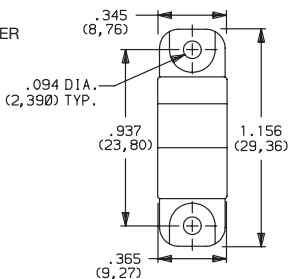

### J2 LEVER

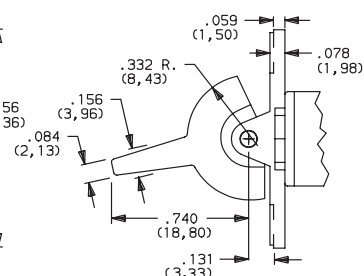
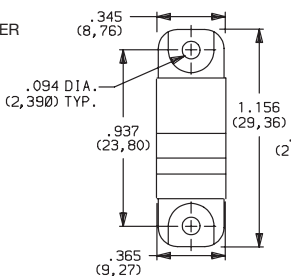

#### PANEL MOUNTING

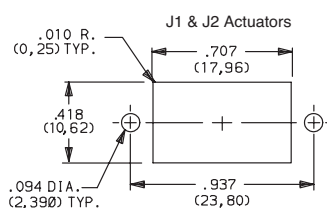

Rocker



Third Angle Projection

Dimensions are shown: Inches (mm)  
Specifications and dimensions subject to change



# E Series Sealed Miniature Rocker and Lever Handle Switches

## ACTUATOR-REAR MOUNT

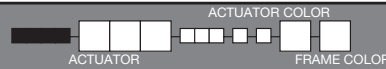

### J11 ROCKER WITH FRAME

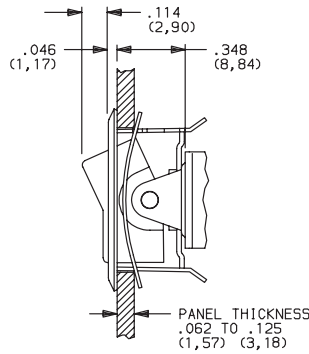
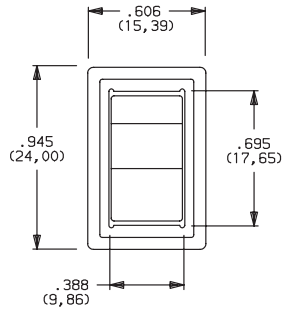

OPTION CODE	ACTUATOR COLOR
2	BLACK
3	RED

OPTION CODE	FRAME COLOR
2	BLACK

NOTE: This option has reduced anti-static capability.

### J21 LEVER WITH FRAME

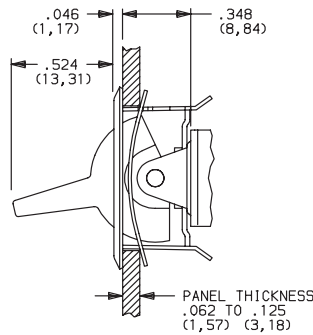
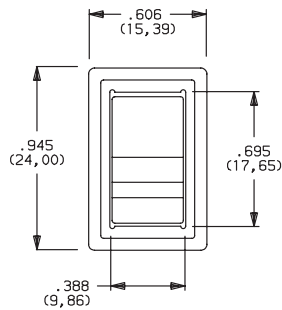

Actuator finish: Matte, frame finish: gloss. Other colors, custom actuator markings and legends available, consult Customer Service Center.

NOTE: Internal o-ring actuator seal standard. Actuators & frames available separately, see page G-36. Hardware available separately, see Technical Data section of this catalog. N. J11 & J21 actuators available with C, Z & Z3 terminations.

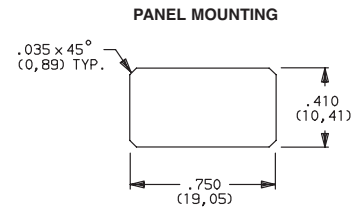

NOTE: This option has reduced anti-static capability.

## ACTUATOR-PC MOUNT

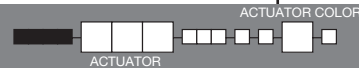

### J1 ROCKER

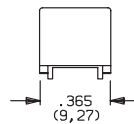
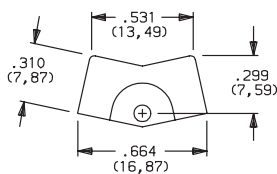
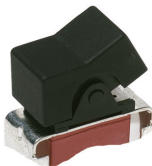

OPTION CODE	ACTUATOR COLOR
2	BLACK
3	RED

### J2 LEVER

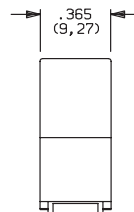
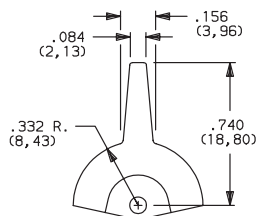
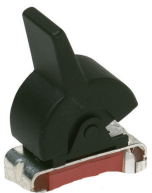

Finish: Matte. Other colors, custom actuator markings and legends available, consult Customer Service Center.

NOTE: Hardware: two each—mounting screws, nuts, lockwashers and standoffs for 1/8 inch thick panel are supplied standard on switches with panel mounting bracket. Internal o-ring actuator seal standard. Actuators available separately, see page G-36. Hardware available separately, see Technical Data section of this catalog. J1, J2 actuators available with A, A3, AV2, AV3, V2-V61 terminations.

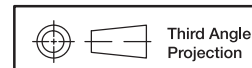

Dimensions are shown: Inches (mm)  
Specifications and dimensions subject to change

# E Series Sealed Miniature Rocker and Lever Handle Switches

## ACTUATOR-PC MOUNT

ACTUATOR COLOR

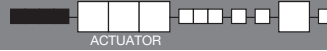

OPTION CODE	ACTUATOR COLOR
2	BLACK
3	RED

Finish: Matte. Other colors, custom actuator markings and legends available, consult Customer Service Center.

**NOTE:** Hardware: two each—mounting screws, nuts, lockwashers and standoffs for 1/8 inch thick panel are supplied standard on switches with panel mounting bracket. Internal o-ring actuator seal standard. Actuators available separately, see page G-36. Hardware available separately, see Technical Data section of this catalog.

J3 actuators available with AV2, AV3 & V2-V61 terminations. Some permissible actuator/termination combinations may lack clearance between actuator and PC board, and care must be exercised to accommodate this condition.

J50, J60 & J90 actuators available with A, AV2, AV3, V2 – V61 terminations.

### J3 ROCKER

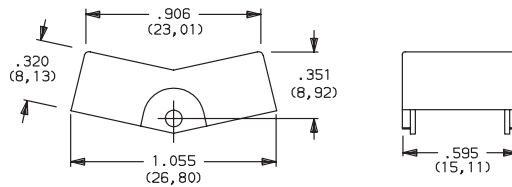

### J50 ROCKER

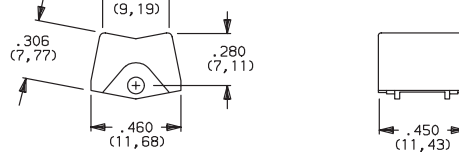

### J60 LEVER

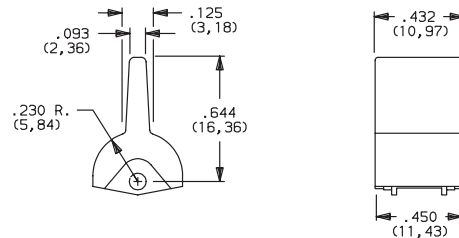

### J90 LEVER

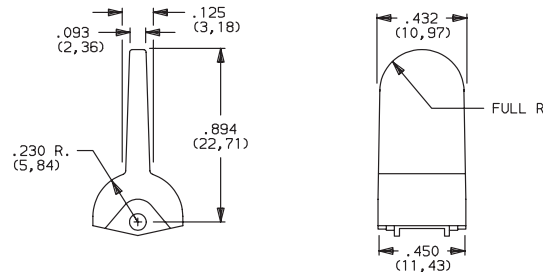

## TERMINATIONS

### Z SOLDER LUG

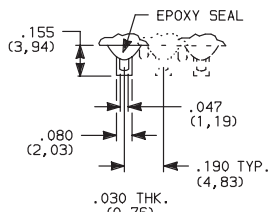

### SPDT thru 3PDT

Not available with P, S, & R contact materials. Available actuators, see page G-27-28.

### C PC THRU-HOLE

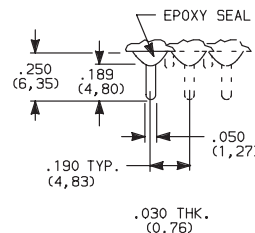

### SPDT thru 3PDT

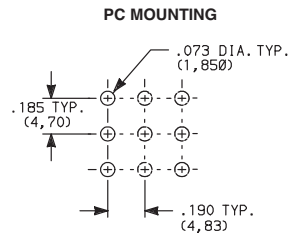

Dimensions are shown: Inches (mm)  
Specifications and dimensions subject to change

Rocker

G



# E Series Sealed Miniature Rocker and Lever Handle Switches

## TERMINATIONS

### Z3 QUICK CONNECT

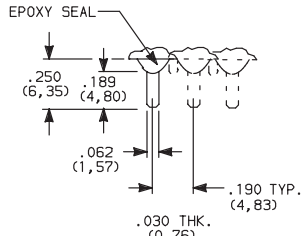

Not available with P, S, & R contact materials. Available actuators, see pages G-27 thru G-28. Mating quick connector available; order part number 530100000, page G-37.

### SPDT thru 3PDT

#### A RIGHT ANGLE, PC THRU-HOLE

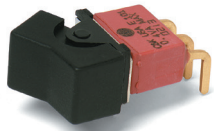

**E101J1ABE2**  
Horizontal Actuation  
**SPDT**

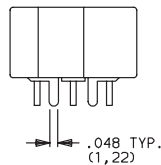

Actuator Shown In Pos. 1

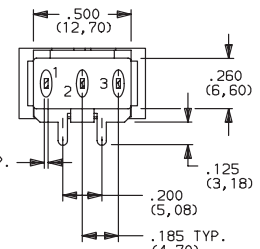
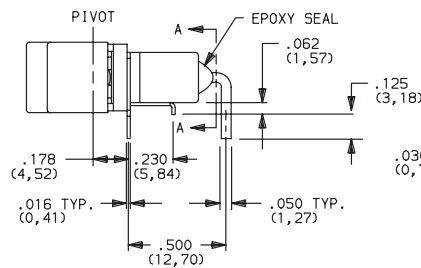

SECTION A-A

#### A3 RIGHT ANGLE, SNAP-IN, PC THRU-HOLE

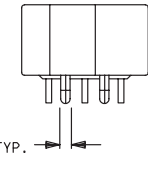

.050 TYP. (1,27)

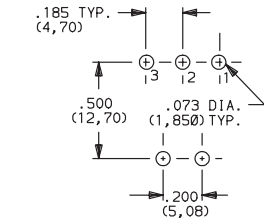
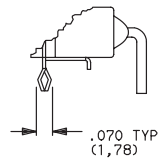

PC MOUNTING

**NOTE:** Not available with J3, J50, J60 and J90 actuators. Available actuators, see pages G-27 thru G-29. Terminal bend radii and lead-in manufacturing option.

**NOTE:** PC mounting pattern must clear switch support leg.

#### A RIGHT ANGLE, PC THRU-HOLE

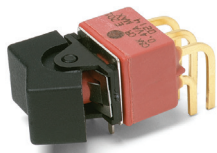

**E201J1ABE2**  
Horizontal Actuation  
**DPDT**

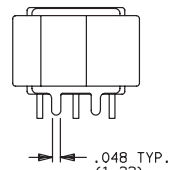

Actuator Shown In Pos. 1

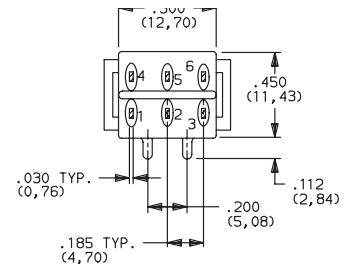
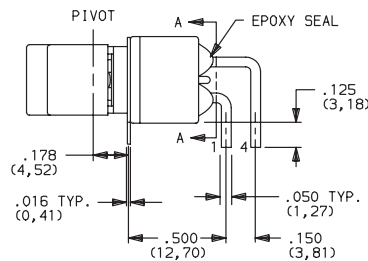

SECTION A-A

#### A3 RIGHT ANGLE, SNAP-IN, PC THRU-HOLE

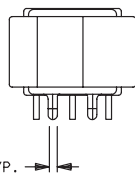

.048 TYP. (1,22)

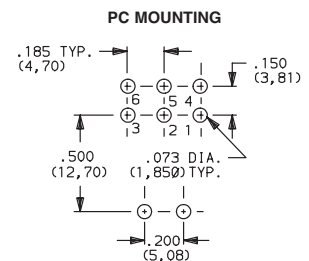
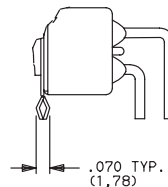

PC MOUNTING

**NOTE:** Not available with J3 actuator. Available actuators, see pages G-27 thru G-29. Terminal bend radii and lead-in manufacturing option.

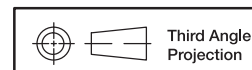

Third Angle Projection

Dimensions are shown: Inches (mm)  
Specifications and dimensions subject to change



# E Series Sealed Miniature Rocker and Lever Handle Switches

## TERMINATIONS

### A RIGHT ANGLE, PC THRU-HOLE

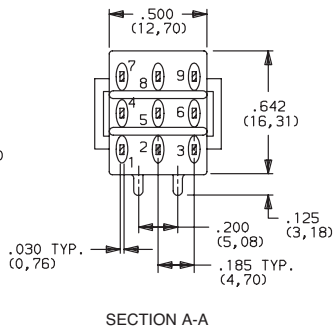
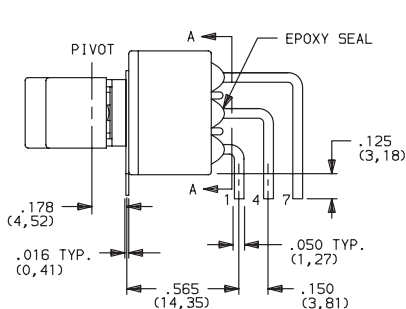
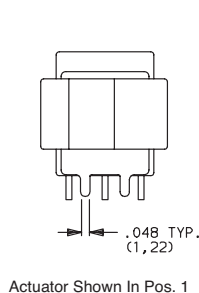

E301J1ABE2  
Horizontal Actuation  
3PDT

### PC MOUNTING

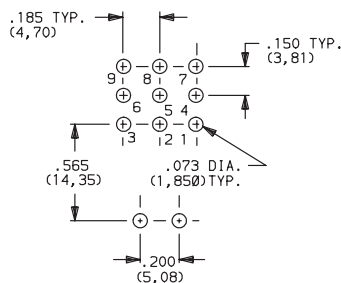

**NOTE:** Terminal bend radii and lead-in manufacturing option. Available actuators, see pages G-27 thru G-29.

### AV2 VERTICAL RIGHT ANGLE, PC THRU-HOLE, .150" PITCH

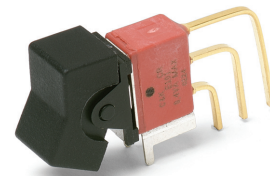
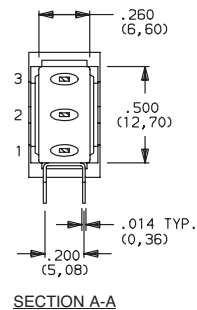
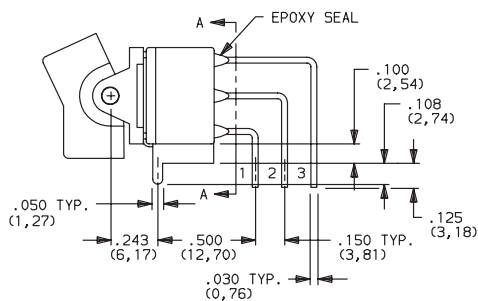
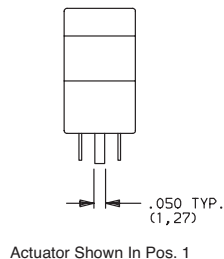

E101J1AV2BE2  
Vertical Actuation  
SPDT

### AV3 VERTICAL RIGHT ANGLE, SNAP-IN, PC THRU-HOLE, .150" PITCH

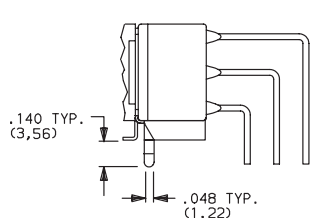
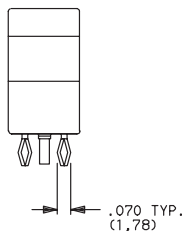

### PC MOUNTING

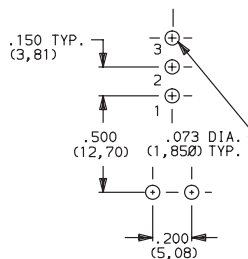

**NOTE:** Terminal bend radii and lead-in manufacturing option. Available actuators, see pages G-27 thru G-29.

Rocker

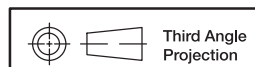

Dimensions are shown: Inches (mm)  
Specifications and dimensions subject to change



# E Series Sealed Miniature Rocker and Lever Handle Switches

## TERMINATIONS



**AV2** VERTICAL RIGHT ANGLE, PC THRU-HOLE, .150" PITCH

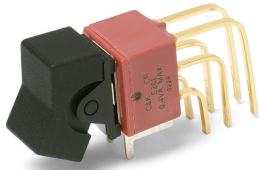

**E201J1AV2BE2**  
Vertical Actuation  
**DPDT**

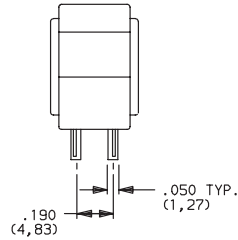

Actuator Shown In Pos. 1

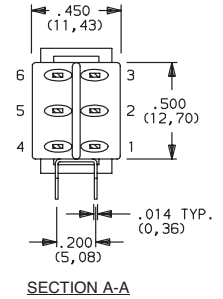
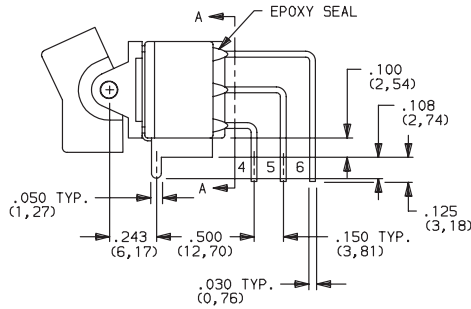

**AV3** VERTICAL RIGHT ANGLE, SNAP-IN, PC THRU-HOLE, .150" PITCH

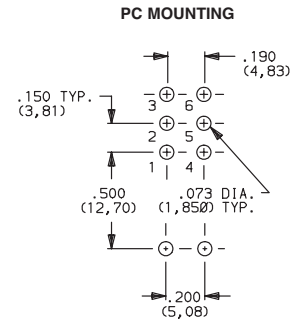
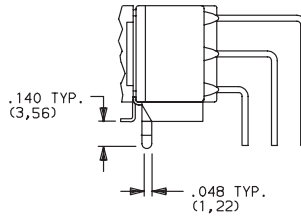
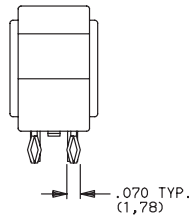

**NOTE:** Terminal bend radii and lead-in manufacturing option. Available actuators, see pages G-27 thru G-29.

**AV2** VERTICAL RIGHT ANGLE, PC THRU-HOLE, .150" PITCH

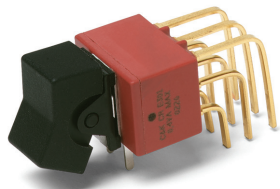

**E301J1AV2BE2**  
Vertical Actuation  
**3PDT**

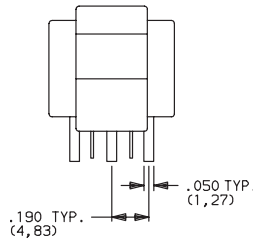

Actuator Shown In Pos. 1

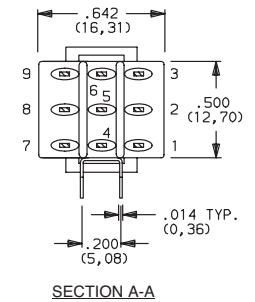
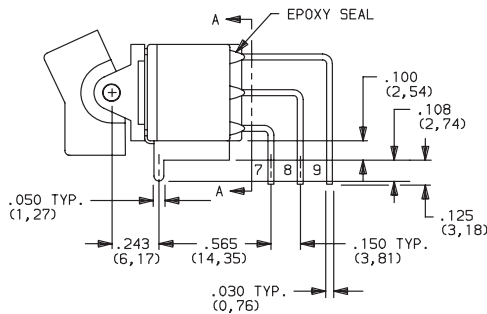

**AV3** VERTICAL RIGHT ANGLE, SNAP-IN, PC THRU-HOLE, .150" PITCH

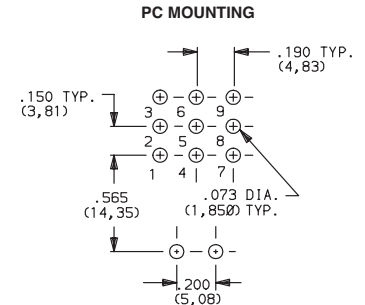
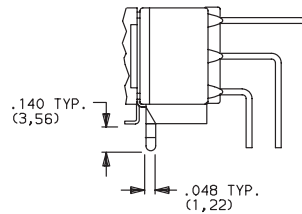
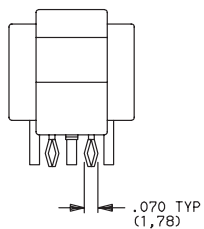

**NOTE:** Terminal bend radii and lead-in manufacturing option. Available actuators, see pages G-27 thru G-29.

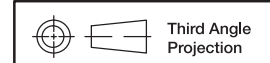

Dimensions are shown: Inches (mm)  
Specifications and dimensions subject to change



# E Series Sealed Miniature Rocker and Lever Handle Switches

## TERMINATIONS

**V5** VERTICAL RIGHT ANGLE, PC THRU-HOLE,  
.150" PITCH

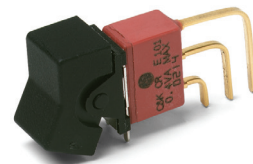
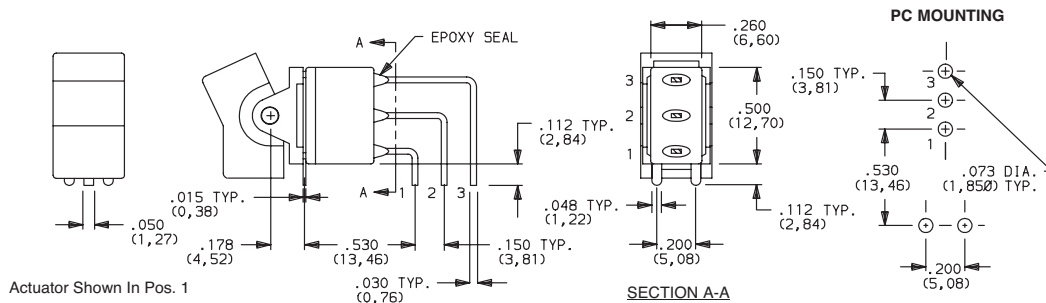

**E101J1V5BE2**  
Vertical Actuation  
**SPDT**

**NOTE:** Terminal bend radii and lead-in manufacturing option.  
Available actuators, see pages G-27 thru G-29.

**V5** VERTICAL RIGHT ANGLE, PC THRU-HOLE,  
.150" PITCH

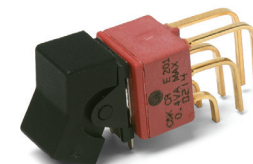
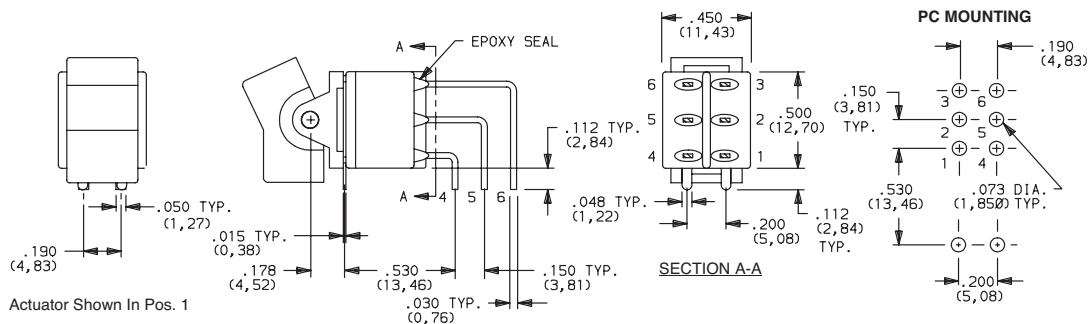

**E201J1V5BE2**  
Vertical Actuation  
**DPDT**

**NOTE:** Terminal bend radii and lead-in manufacturing option.  
Available actuators, see pages G-27 thru G-29.

# E Series Sealed Miniature Rocker and Lever Handle Switches

## TERMINATIONS

**V6, V7, V8** VERTICAL MOUNT, V-BRACKET

**V21** VERTICAL MOUNT, V-BRACKET, SNAP-IN

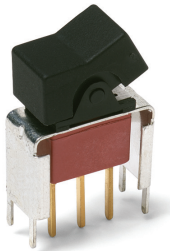

**E101J1\_BE2**  
**SPDT**

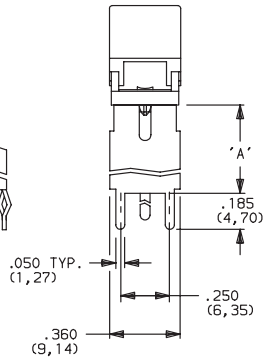
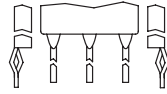
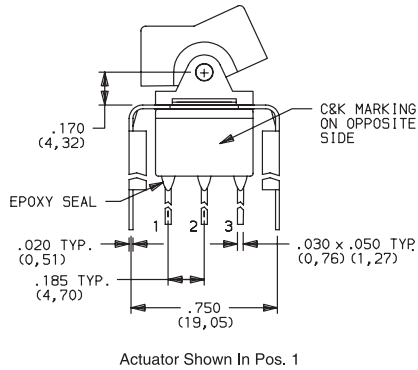

### PC MOUNTING

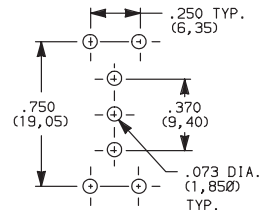

OPTION CODE	DIM 'A'
<b>V21</b>	.555 (14, 10)
<b>V6</b>	.460 (11, 68)
<b>V7</b>	.630 (16, 00)
<b>V8</b>	.953 (24, 21)

NOTE: Available actuators, see pages G-27 thru G-29.

**V6, V7, V8** VERTICAL MOUNT, V-BRACKET

**V21** VERTICAL MOUNT, V-BRACKET, SNAP-IN

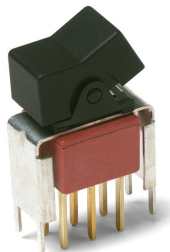

**E201J1\_BE2**  
**DPDT**

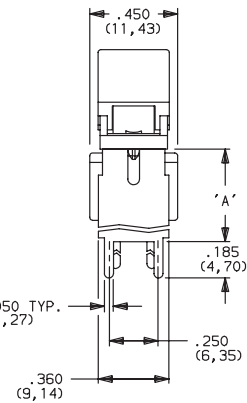
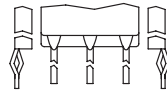
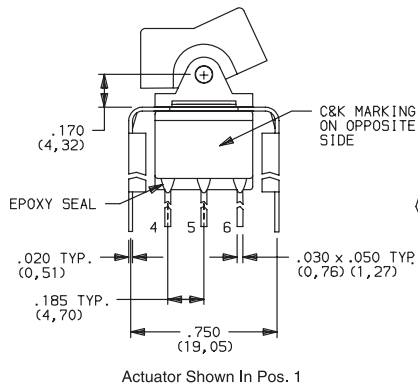

### PC MOUNTING

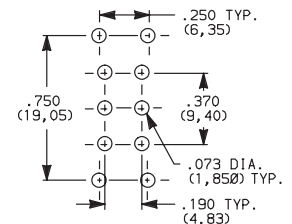

OPTION CODE	DIM 'A'
<b>V21</b>	.555 (14, 10)
<b>V6</b>	.460 (11, 68)
<b>V7</b>	.630 (16, 00)
<b>V8</b>	.953 (24, 21)

NOTE: Available actuators, see pages G-27 thru G-29.

**V7, V8** VERTICAL MOUNT, V-BRACKET

**V21** VERTICAL MOUNT, V-BRACKET, SNAP-IN

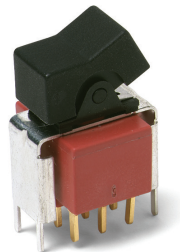

**E301J1\_BE2**  
**3PDT**

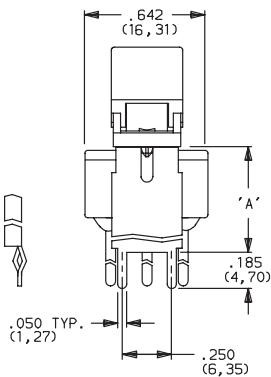
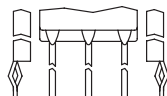
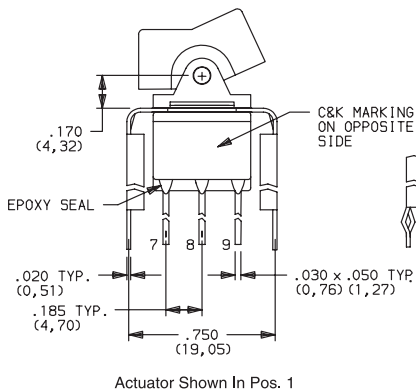

### PC MOUNTING

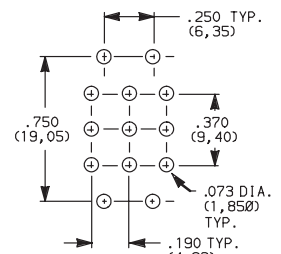

OPTION CODE	DIM 'A'
<b>V21</b>	.555 (14, 10)
<b>V7</b>	.630 (16, 00)
<b>V8</b>	.953 (24, 21)

NOTE: Available actuators, see pages G-27 thru G-29.

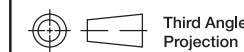

Dimensions are shown: Inches (mm)  
Specifications and dimensions subject to change



# E Series Sealed Miniature Rocker and Lever Handle Switches

## TERMINATIONS

**V3, V4** VERTICAL MOUNT, V-BRACKET

**V31** VERTICAL MOUNT, V-BRACKET, SNAP-IN

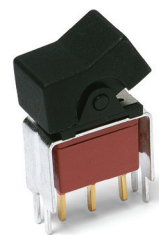

**E101J1\_BE2**  
**SPDT**

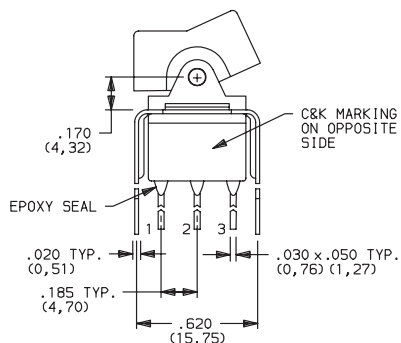

Actuator Shown In Pos. 1

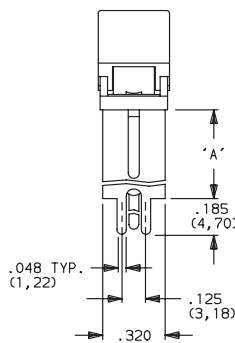
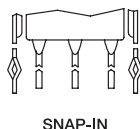

### PC MOUNTING

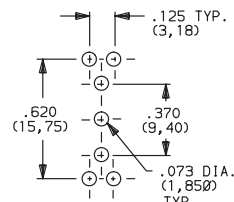

OPTION CODE	DIM 'A'
<b>V3, V31</b>	.460 (11,68)
<b>V4</b>	.630 (16,00)

**V3, V4** VERTICAL MOUNT, V-BRACKET

**V31** VERTICAL MOUNT, V-BRACKET, SNAP-IN

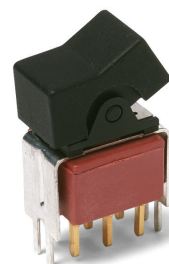

**E201J1\_BE2**  
**DPDT**

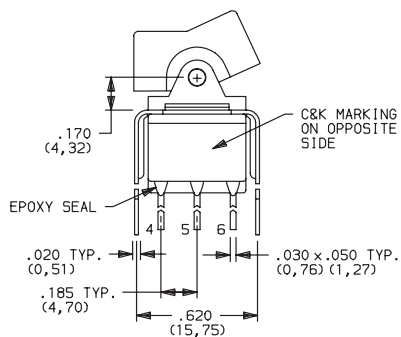

Actuator Shown In Pos. 1

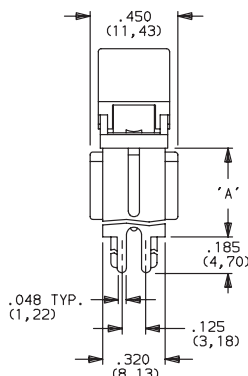
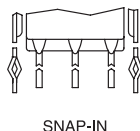

### PC MOUNTING

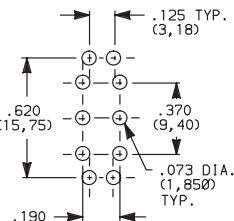

OPTION CODE	DIM 'A'
<b>V3, V31</b>	.460 (11,68)
<b>V4</b>	.630 (16,00)

**NOTE:** Available actuators, see pages G-27 thru G-29.

**V4** VERTICAL MOUNT, V-BRACKET

VERTICAL MOUNT, V-BRACKET, SNAP-IN

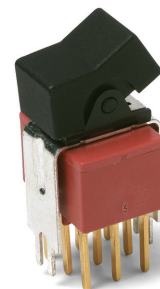

**E301J1\_BE2**  
**3PDT**

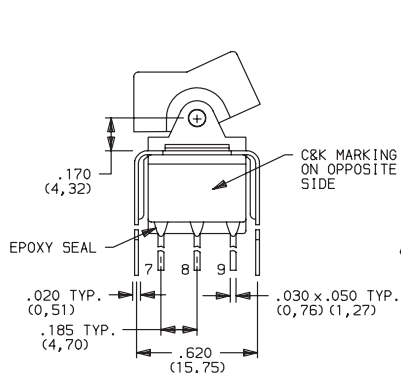

Actuator Shown In Pos. 1

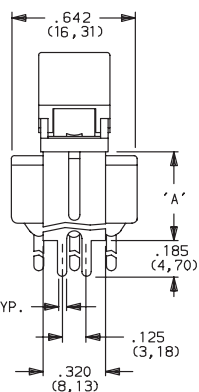
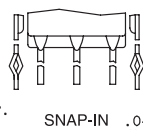

### PC MOUNTING

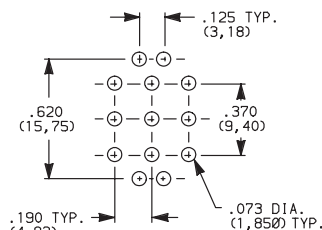

OPTION CODE	DIM 'A'
<b>V41</b>	.630 (16,00)

**NOTE:** Available actuators, see pages G-27 thru G-29.



Third Angle Projection  
Dimensions are shown: Inches (mm)  
Specifications and dimensions subject to change

Rocker



# E Series Sealed Miniature Rocker and Lever Handle Switches

## CONTACT MATERIAL

OPTION CODE	CONTACT MATERIAL	TERMINAL PLATING	RATINGS	
<b>B</b>	GOLD <sup>1</sup>	GOLD <sup>1</sup>	LOW LEVEL/ DRY CIRCUIT	0.4 VA MAX. @ 20 V AC OR DC MAX.
<b>P</b>		MATTE-TIN <sup>7</sup>		
<b>Q</b>	SILVER <sup>4,5</sup>	SILVER <sup>5</sup>	POWER	E1XX & E2XX MODELS: 7.5 AMPS @125 V AC OR 28 V DC; 3 AMPS @250 V AC. E3XX MODELS: 5 AMPS @ 125 V AC OR 28 V DC; 2 AMPS @ 250 V AC.
<b>S</b>		MATTE-TIN <sup>6</sup>		
<b>G</b>	GOLD OVER SILVER <sup>2,3</sup>	GOLD <sup>3</sup>	LOW LEVEL/DRY CIRCUIT OR POWER	E1XX AND E2XX MODELS: 0.4 VA MAX @20 V AC OR DC MAX. OR 7.5 AMPS @125 V AC OR 28 V DC; 3 AMPS @ 250 V AC. DC E3XX MODELS: 0.4 VA MAX. @ 20 V AC OR DC MAX. OR 5 AMPS @ 125 V AC OR 28 V DC; 2 AMPS @ 250 V AC.
<b>R</b>		MATTE-TIN <sup>6</sup>		

\* Note: See Technical Data section of this catalog for RoHS compliant and compatible definitions and specifications.

<sup>1</sup> CONTACTS & TERMINALS: Copper alloy, with gold plate over nickel plate.

<sup>2</sup> END CONTACTS: Coin silver, with gold plate over nickel plate.

<sup>3</sup> CENTER CONTACTS & ALL TERMINALS: Copper alloy, with gold plate over nickel plate.

<sup>4</sup> END CONTACTS: Coin silver, silver plated.

<sup>5</sup> CENTER CONTACT & ALL TERMINALS: Copper alloy, with gold flash over silver plate. Or copper alloy, silver plated.

<sup>6</sup> TERMINALS: Copper alloy, with matte-tin over nickel plate.

**NOTE:** Any models supplied with Q, B, G, S P & R contact material are RoHS compliant.

All models with all options when ordered with G, Q, S & R contact material.

B contact material standard with all terminations.

P R & S contact materials not available with Z terminations.

## SEAL

**E** EPOXY SEAL



## AVAILABLE HARDWARE

J2, J21 Actuators



PART NO.  
**760502263** BLACK  
**760503000** RED

Material: Nylon  
Finish: Matte

J3 Actuator



PART NO.  
**766602263** BLACK  
**766603000** RED

Material: Nylon  
Finish: Matte

J1, J11 Actuators



PART NO.  
**776A02263** BLACK  
**776A03000** RED

Material: Nylon  
Finish: Matte

J50 Actuator

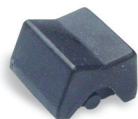

PART NO.  
**775A02263** BLACK  
**775A03000** RED

Material: Nylon  
Finish: Matte

J60 Actuator



PART NO.  
**613802263** BLACK  
**598103000** RED

Material: Nylon  
Finish: Matte

J90 Actuator



PART NO.  
**598002263** BLACK  
**598003000** RED

Material: Nylon  
Finish: Matte

NOTE: Additional nuts, screws and lockwashers available separately, see Technical Data section of this catalog. Other colors available, consult Customer Service Center.

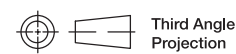

Dimensions are shown: Inches (mm)  
Specifications and dimensions subject to change

**C&K**



# E Series Sealed Miniature Rocker and Lever Handle Switches

## AVAILABLE HARDWARE

Fits Z3 Termination female connector



PART NO.  
**530100000**

Available in loose pieces.

Frame for J11, J21 Actuators



PART NO.  
**764500746** BLACK ENAMEL  
**764601106** RETAINING SPRING

Material: Spring Steel



J50, J60 & J90 Actuators

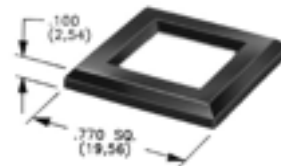

MATTE

PART NO.

**486702000**

Material: Nylon  
Finish: Matte or Gloss

GLOSS

PART NO.

**486802000** BLACK

**NOTE:** Additional nuts, screws and lockwashers available separately, see Technical Data section of this catalog. Other colors available, consult Customer Service Center.

Frames snap into panel opening and are independent from switch mounting. Accurate positioning of the PC mounted switch relative to the panel opening is necessary to provide proper clearance between actuator and frame. Available in two basic styles and four panel thicknesses .047-.125 in. Material: Nylon. Finish: Matte.

TYPICAL APPLICATION

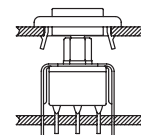

J1 & J2 Actuators

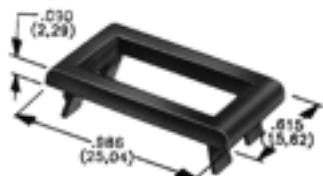

.047" (1,19) PANEL THK.    .062" (1,57) PANEL THK.    .090" (2,29) PANEL THK.    .125" (3,18) PANEL THK.

PART NO.	PART NO.	PART NO.	PART NO.
<b>452902263</b>	<b>452702263</b>	<b>452802263</b>	<b>452602263</b> BLACK
<b>452903000</b>	<b>452703000</b>	<b>452803000</b>	<b>452603000</b> RED

J50, J60 & J90 Actuators

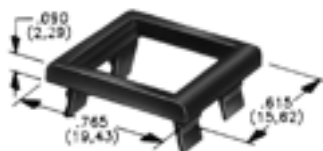

.047" (1,19) PANEL THK.    .062" (1,57) PANEL THK.    .090" (2,29) PANEL THK.    .125" (3,18) PANEL THK.

PART NO.	PART NO.	PART NO.	PART NO.
<b>432502263</b>	<b>432602263</b>	<b>432702263</b>	<b>432802263</b> BLACK
<b>432503000</b>	<b>432603000</b>	<b>432703000</b>	<b>432803000</b> RED

### PANEL MOUNTING

For part numbers  
4529xxxxx, 4527xxxxx,  
4528xxxxx, 4526xxxxx

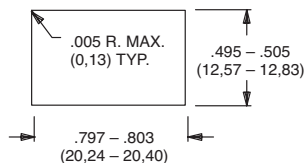

For part numbers  
4325xxxxx, 4326xxxxx

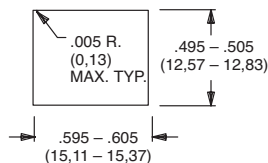

For part numbers  
4327xxxxx, 4328xxxxx

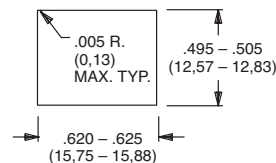

Dimensions are shown: Inches (mm)  
Specifications and dimensions subject to change

Rocker

G



# E Series Sealed Miniature Rocker and Lever Handle Switches

## AVAILABLE HARDWARE

### Panel Inserts

Will fit separate snap-in frames for J50, J60, J90 actuators.

Above frames (part nos. 432XXXXXX) are also available with insert which accepts LED for indicator light assembly. Order insert separately from frame. Blank insert panel (without hole for LED) also available. **LED not included.**

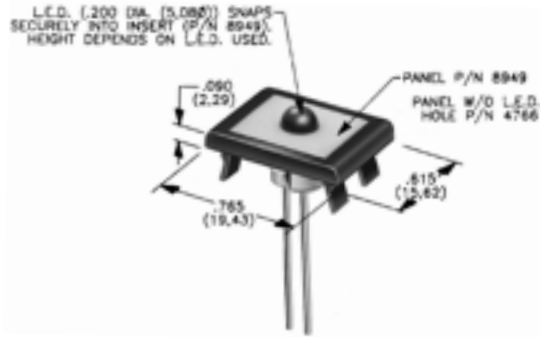

PANEL INSERT  
WITH HOLE FOR LED

BLANK PANEL INSERT  
WITHOUT HOLE FOR LED

PART NO.

894902000  
894903000

PART NO.

476602000 BLACK  
476603000 RED

NOTE: Special colors, custom markings available, consult Customer Service Center.

# ET Series Sealed Subminiature Rocker Switches

## Features/Benefits

- Sealed against solder and cleaning process contaminants
- Rocker, bushing & case—UL 94V-0
- Small footprint—saves space
- RoHS compliant

## Typical Applications

- Telecommunications
- Instrumentation
- Computers & peripherals

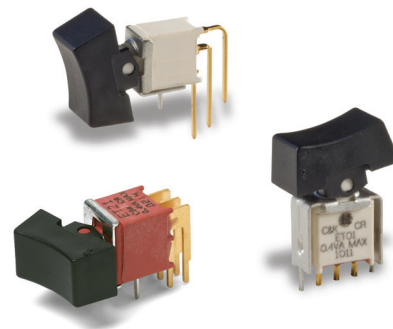

## Specifications

**CONTACT RATING:** B contact material: 0.4 VA max. @ 20 V AC or DC max. Q contact material: Copper alloy, silver plated. See page G-43 for additional ratings.

**ELECTRICAL LIFE:** ETX1 models: 60,000 make-and-break cycles at full load. All other models: 30,000 cycles.

**CONTACT RESISTANCE:** Below 20 m Ω typ. initial @ 2-4 V DC, 100 mA, for both silver and gold plated contacts.

**INSULATION RESISTANCE:** 10<sup>9</sup> Ω min.

**DIELECTRIC STRENGTH:** 1000 Vrms min. @ sea level.

**OPERATING TEMPERATURE:** -30°C to 85°C.

**SOLDERABILITY:** Per MIL-STD-202F method 208D, or EIA RS-186E method 9 (1 hour steam aging).

**PACKAGING:** Surface mount switches standard in tape and reel packaging, see page G-45 for drawings and reel information.

## Materials

**CASE & BUSHING:** Glass filled nylon 6/6, flame retardant, heat stabilized (UL 94V-0) or glass filled 4/6 nylon, flame retardant, heat stabilized (UL 94V-0).

**ACTUATOR:** Nylon, black standard. Internal o-ring seal standard with all actuators. SA surface mount: High temperature material, glass filled 46 nylon, flame retardant, heat stabilized (UL 94V-0).

**SWITCH SUPPORT:** Brass, matte-tin plated.

**CONTACTS & TERMINALS:** B contact material: Copper alloy, with gold plate over nickel plate. Q contact material: Copper alloy, silver plated. See page G-43 for additional contact materials.

**TERMINAL SEAL:** Epoxy.

**NOTE:** Any models supplied with Q, B, G, S, P & R contact material are RoHS compliant.

**NOTE:** Specifications and materials listed above are for switches with standard options. For information on specific and custom switches, consult Customer Service Center.

## Build-A-Switch

To order, simply select desired option from each category and place in the appropriate box. Available options are shown and described on pages G-40 thru G-44. For additional options not shown in catalog, consult Customer Service Center. All models are process sealed to withstand machine soldering temperatures and pressure wash cleaning methods.

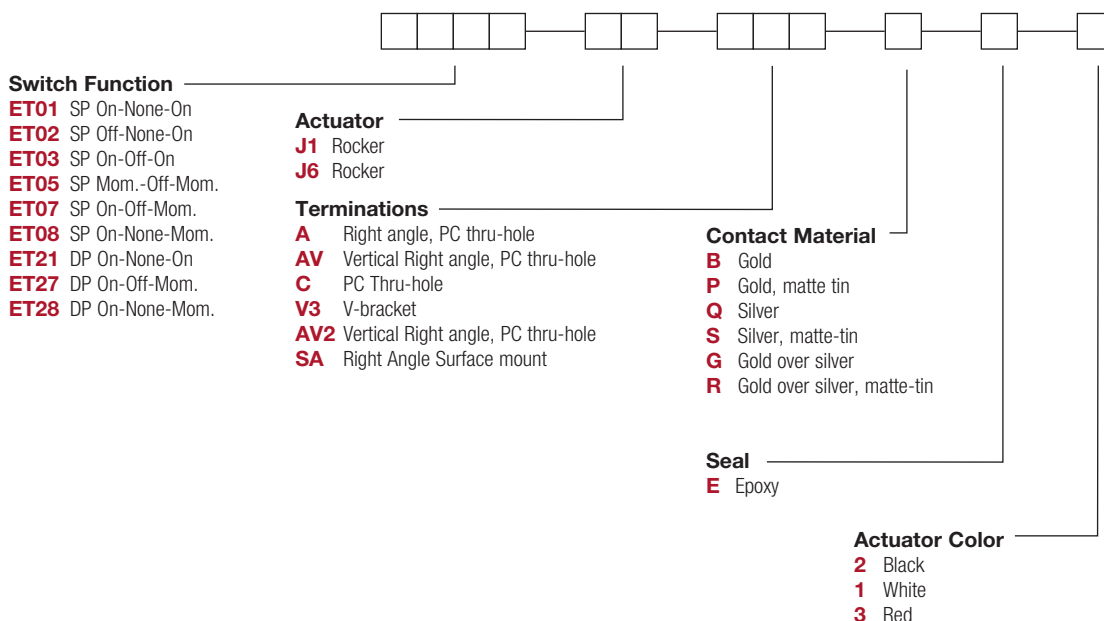



# ET Series Sealed Subminiature Rocker Switches

## SWITCH FUNCTION

NO. POLES	MODEL NO.	SWITCH FUNCTION			CONNECTED TERMINALS			SCHEMATIC
		POS. 1	POS. 2	POS. 3	POS. 1	POS. 2	POS. 3	
SP	<b>ET01</b>	ON	NONE	ON	2-3	N/A	2-1	
	<b>ET03</b>	ON	OFF	ON		OPEN		
	<b>ET05</b>	MOM.	OFF	MOM.		OPEN		
	<b>ET07</b>	ON	OFF	MOM.	N/A	SPDT		
	<b>ET08</b>	ON	NONE	MOM.	OPEN	N/A	3-1	
<p><b>SPDT</b></p> <p>Part number shown: ET01J6CBE2</p> <p>ET02 Models: Omit terminal 2</p> <p>Terminal Nos. For Reference Only</p>								
DP	<b>ET21</b>	ON	NONE	ON	2-3,5-6	N/A	2-1,5-4	
	<b>ET27</b>	ON	OFF	MOM.		OPEN		
	<b>ET28</b>	ON	NONE	MOM.		N/A		
<p><b>DPDT</b></p> <p>Part number shown: ET21J6CBE2</p> <p>Terminal Nos. For Reference Only</p>								

MOM. = Momentary

All models with all options when ordered with G, S, R or Q contact material.

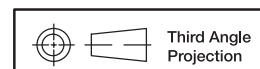

Dimensions are shown: Inches (mm)  
Specifications and dimensions subject to change



# ET Series Sealed Subminiature Rocker Switches

## ACTUATOR

### J1 ROCKER

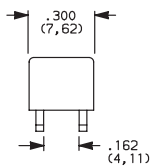
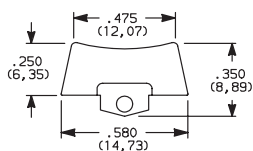

#### PANEL MOUNTING

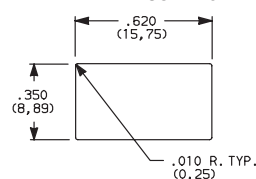

Available with all models except ET0X with A & SA & SA1 terminations.

### J6 ROCKER

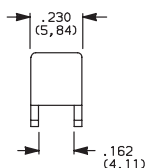
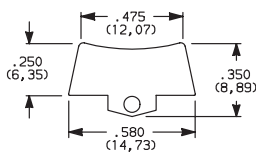

#### PANEL MOUNTING

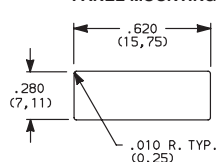

Standard with ET0X model with A & SA & SA1 terminations.

OPTION CODE	ACTUATOR COLOR
<b>2</b>	<b>BLACK</b>
<b>1</b>	<b>WHITE</b>
<b>3</b>	<b>RED</b>

Actuators available separately, see page G-45. Finish: Matte. Other colors, custom actuator markings and legends available, consult Customer Service Center.

**NOTE:** Internal o-ring actuator seal standard.

## TERMINATIONS

### C PC THRU-HOLE

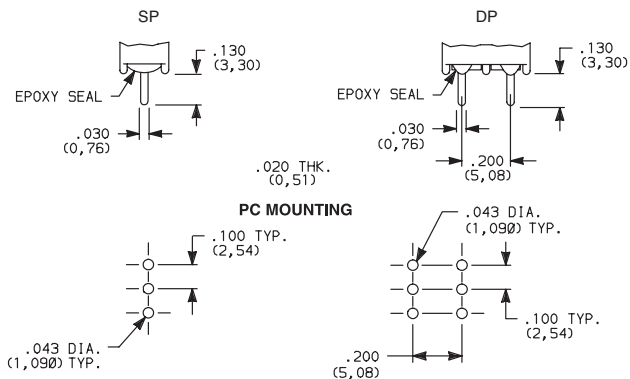

ET02 Models: Omit center hole.

### SP & DP

#### A RIGHT ANGLE, PC THRU-HOLE

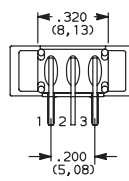
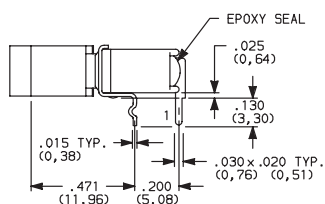
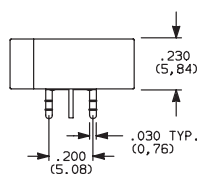

#### PC MOUNTING

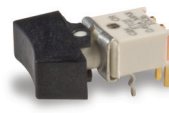
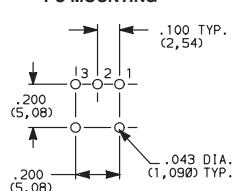

**ET01J6ABE2**  
Horizontal Actuation  
**SPDT**

Actuator Shown In Pos. 1

Not available with ET02 model.

J6 actuator std. only on ET0X models with A terminations.

#### A RIGHT ANGLE, PC THRU-HOLE

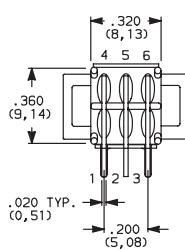
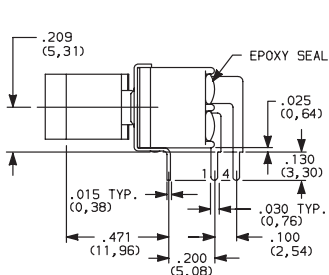
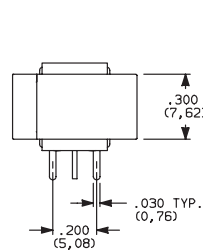

#### PC MOUNTING

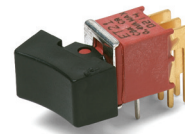
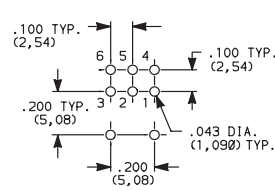

**ET21J1ABE2**  
Horizontal Actuation  
**DPDT**

Actuator Shown In Pos. 1



Third Angle  
Projection

Dimensions are shown: Inches (mm)  
Specifications and dimensions subject to change

Rocker

G

**C&K**

# ET Series Sealed Subminiature Rocker Switches

## TERMINATIONS

### AV VERTICAL RIGHT ANGLE, PC THRU-HOLE

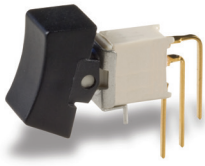

**ET01J1AVBE2**  
Vertical Actuation  
**SPDT**

Actuator Shown In Pos. 1

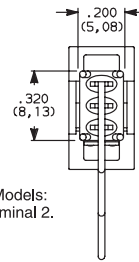
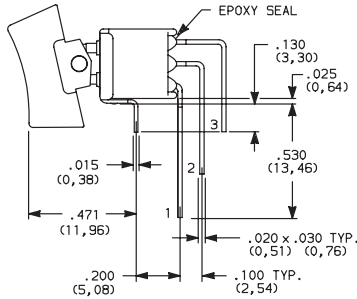
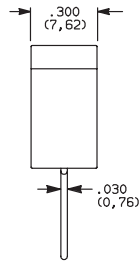

ET02 Models:  
Omit terminal 2.

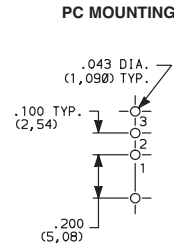

**NOTE:** Terminal bend radii and lead-in manufacturing option.

### AV VERTICAL RIGHT ANGLE, PC THRU-HOLE

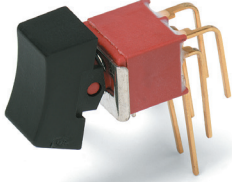

**ET21J1AVBE2**  
Vertical Actuation  
**DPDT**

Actuator Shown In Pos. 1

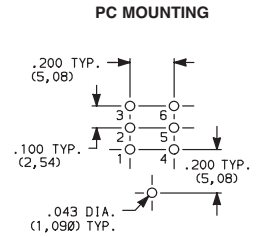
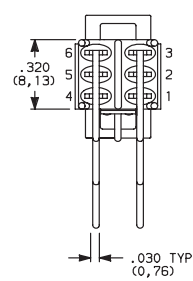
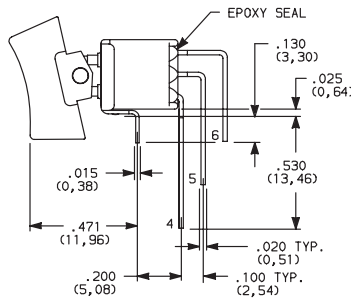
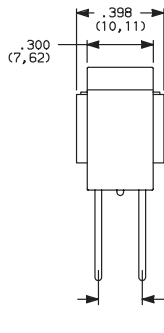

**NOTE:** Terminal bend radii and lead-in manufacturing option.

### AV2 VERTICAL RIGHT ANGLE, PC THRU-HOLE

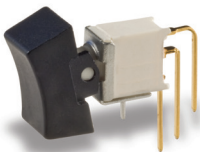

**ET01J1AV2BE2**  
Vertical Actuation  
**SPDT**

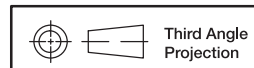
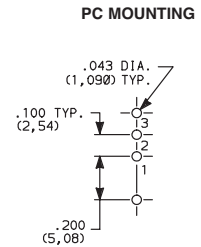
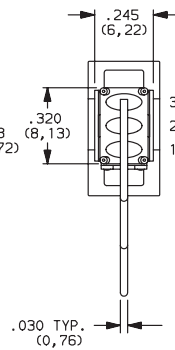
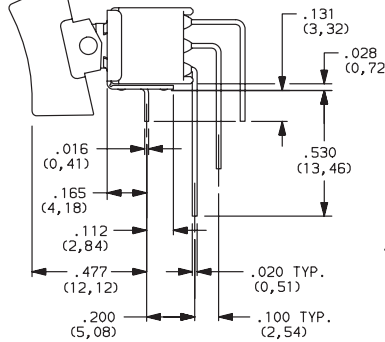
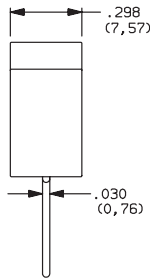

Third Angle  
Projection

Dimensions are shown: Inches (mm)  
Specifications and dimensions subject to change



# ET Series Sealed Subminiature Rocker Switches

## TERMINATIONS

### SA RIGHT ANGLE, SURFACE MOUNT

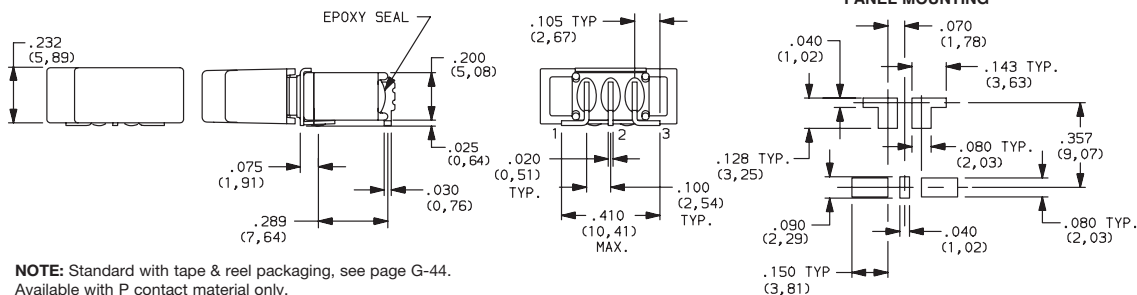

ET01J6SAPE2  
Horizontal Actuation  
SPDT

### V3 VERTICAL MOUNT, V-BRACKET

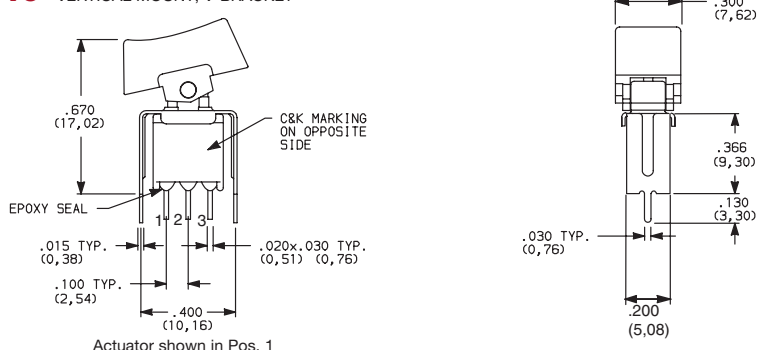

ET01J1V3BE2  
SPDT

### V3 VERTICAL MOUNT, V-BRACKET

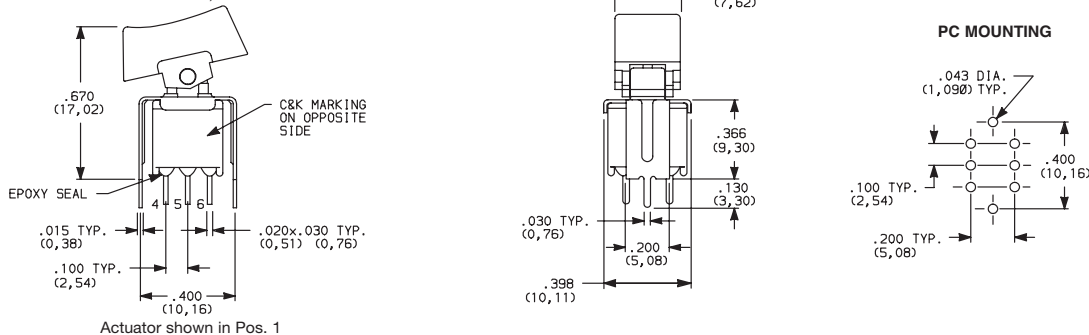

ET21J1V3BE2  
DPDT

## CONTACT MATERIAL

OPTION CODE	CONTACT MATERIAL	TERMINAL PLATING	RATINGS	
<b>B</b>	GOLD <sup>1</sup>	GOLD <sup>1</sup>	LOW LEVEL/ DRY CIRCUIT	0.4 VA MAX. @ 20 V AC OR DC MAX.
<b>P</b>		MATTE-TIN <sup>6</sup>		
<b>Q</b>	SILVER <sup>4,5</sup>	SILVER <sup>5</sup>	POWER	ETX1 MODELS: 3 AMPS @ 120 V AC OR 28 V DC. ALL OTHER MODELS: 2 AMPS @ 120 V AC OR 28 V DC.
<b>S</b>		MATTE-TIN <sup>6</sup>		
<b>G</b>	GOLD OVER SILVER <sup>2,3</sup>	GOLD <sup>3</sup>	LOW LEVEL/DRY CIRCUIT OR POWER	ETX1 MODELS: 0.4 VA MAX @ 20 V AC OR DC MAX. OR 3 AMPS @ 120 V AC OR 28 V DC. ALL OTHER MODELS: 0.4 VA MAX @ 20 V AC OR DC MAX. OR 2 AMPS @ 120 V AC OR 28 V DC.
<b>R</b>		MATTE-TIN <sup>6</sup>		

\* Note: See Technical Data section of this catalog for RoHS compliant and compatible definitions and specifications.

<sup>1</sup> CONTACTS & TERMINALS: Copper alloy, with gold plate over nickel plate.

<sup>2</sup> END CONTACTS: Coin silver, with gold plate over nickel plate.

<sup>3</sup> CENTER CONTACTS & ALL TERMINALS: Copper alloy, with gold plate over nickel plate.

<sup>4</sup> END CONTACTS: Coin silver, silver plated.

<sup>5</sup> CENTER CONTACT & ALL TERMINALS: Copper alloy, silver plated.

<sup>6</sup> TERMINALS: Copper alloy, with matte-tin over nickel plate.

**NOTE:** Any models supplied with Q, B, G, S, P & R contact material are RoHS compliant.

All models with all options when ordered with G, Q, S & R contact material.



Dimensions are shown: Inches (mm)  
Specifications and dimensions subject to change

# ET Series Sealed Subminiature Rocker Switches

SEAL



**E** EPOXY SEAL

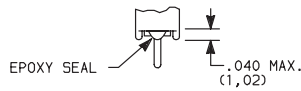

## AVAILABLE HARDWARE

J1 Actuator



PART NO.

**261A01000** WHITE  
**261A02263** BLACK  
**261A03000** RED

Material: Nylon  
Finish: Matte

NOT AVAILABLE WITH A, SA,  
SA1

J6 Actuator



PART NO.

**621C01000** WHITE  
**621C02263** BLACK  
**621C03000** RED

Material: Nylon  
Finish: Matte

For Hi Temp, Consult Factory

NOTE: Other colors available,  
consult Customer Service Center.

## TAPE & REEL SA TERMINATION

ET01J6SABE (SHOWN)

REEL INFORMATION	
OUTSIDE DIAMETER	13.00 (330,0)
PILOT HOLE	.512 (13,0)
QUANTITY PER REEL	500

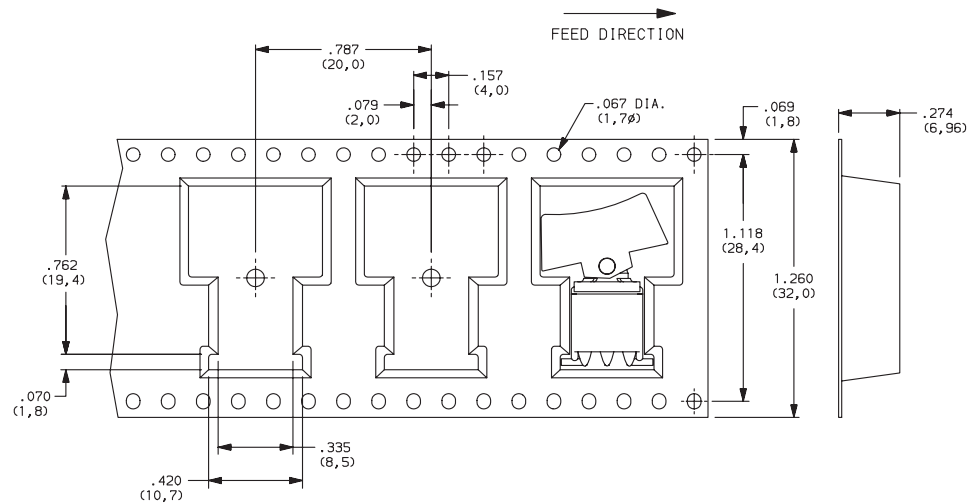

ET01J6SA1BE (SHOWN)

REEL INFORMATION	
OUTSIDE DIAMETER	13.00 (330,0)
PILOT HOLE	.795 (20,20)
QUANTITY PER REEL	450

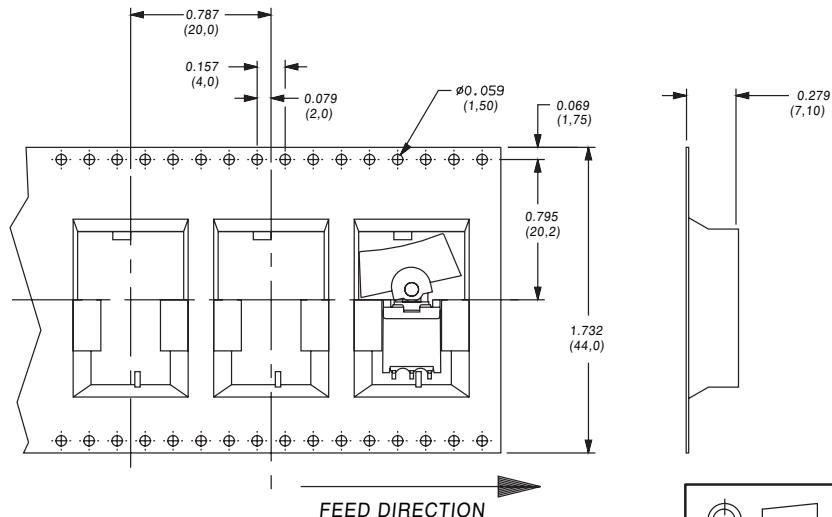

Third Angle  
Projection

Dimensions are shown: Inches (mm)  
Specifications and dimensions subject to change



# T Series Subminiature Rocker Switches

## Features/Benefits

- Compact size—small footprint
- Single and double pole models
- PC and panel mounting options available
- RoHS compliant

## Typical Applications

- Telecommunications
- Instrumentation
- Medical Equipment

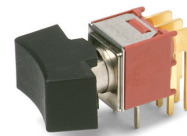
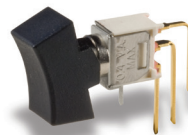

Models Available

## Specifications

CONTACT RATING: Q contact material (TX01 models): 3 AMPS @ 120 V AC or 28 V DC. All other models: 2 AMPS @ 120 V AC or 28 V DC. See page G-49 for additional ratings.

ELECTRICAL LIFE: TX01 models: 60,000 make-and-break cycles at full load. All other models: 30,000 cycles.

CONTACT RESISTANCE: Below 20 m Ω typ. initial @ 2–4 V DC, 100 mA, for both silver and gold plated contacts.

INSULATION RESISTANCE: 10<sup>9</sup> Ω min.

DIELECTRIC STRENGTH: 1000 Vrms min. @ sea level.

OPERATING TEMPERATURE: –30°C to 85°C.

SOLDERABILITY: Per MIL-STD-202F method 208D, or EIA RS-186E method 9 (1 hour steam aging).

**NOTE:** Any models supplied with B, G, P, Q or R contact material are RoHS compliant.

**NOTE:** Specifications and materials listed above are for switches with standard options. For information on specific and custom switches, consult Customer Service Center.

## Materials

CASE: Glass filled nylon 6/6, flame retardant, heat stabilized or diallyl phthalate (DAP), (UL 94V-0) or glass filled nylon 4/6, flame retardant, heat stabilized.

ACTUATOR: Nylon, black standard.

BUSHING: Brass, nickel plated.

HOUSING: Stainless steel.

SWITCH SUPPORT: Brass, matte-tin plated.

MOUNTING BRACKET: Stainless steel.

END CONTACTS: B contact material: Copper alloy, with gold plate over nickel plate. Q contact material: Coin silver, silver plated. See page G-49 for additional contact materials.

CENTER CONTACTS & TERMINALS: B contact material: Copper alloy, with gold plate over nickel plate. Q contact material: Copper alloy, silver plated. See page G-49 for additional contact materials.

TERMINAL SEAL: Epoxy.

HARDWARE: Nut, Screws & Lockwasher: Stainless steel.  
Standoff: Nylon standard.

## Build-A-Switch

To order, simply select desired option from each category and place in the appropriate box. Available options are shown and described on pages G-46 through G-50. For additional options not shown in catalog, consult Customer Service Center. All models have epoxy terminal seal and are compatible with all “bottom-wash” PCB cleaning methods.

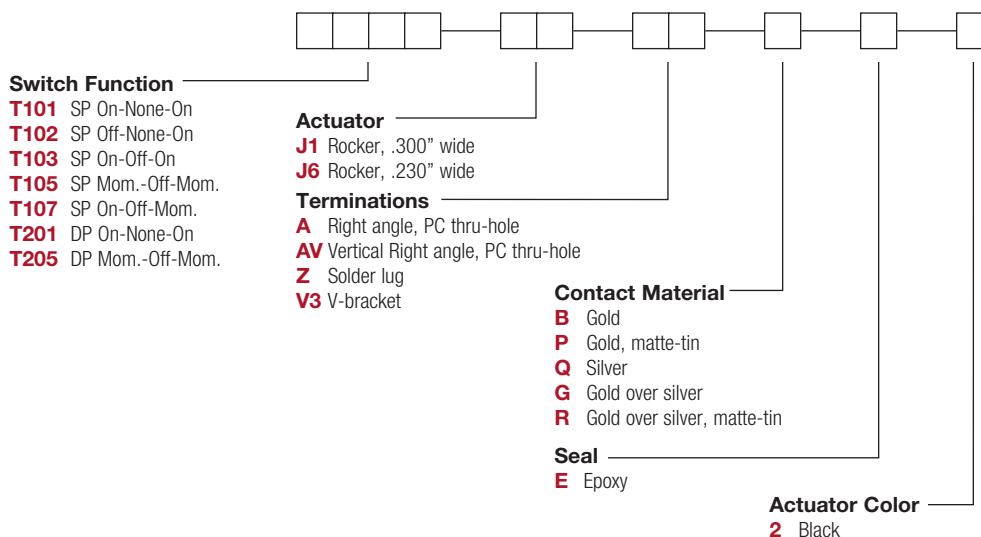

# T Series Subminiature Rocker Switches

ACTUATOR COLOR

SWITCH FUNCTION



NO. POLES	MODEL NO.	SWITCH FUNCTION			CONNECTED TERMINALS			SCHEMATIC
		POS. 1	POS. 2	POS. 3	POS. 1	POS. 2	POS. 3	
		C&K marking on opposite side			C&K marking on opposite side			
SP	<b>T101</b>	ON	NONE	ON	2-3	N/A	2-1	
	<b>T103</b>	ON	OFF	ON		OPEN		
	<b>T105</b>	MOM.	OFF	MOM.				
	<b>T107</b>	ON	OFF	MOM.				
	<b>T102</b>	OFF	NONE	ON	OPEN	N/A	3-1	

**SPDT**

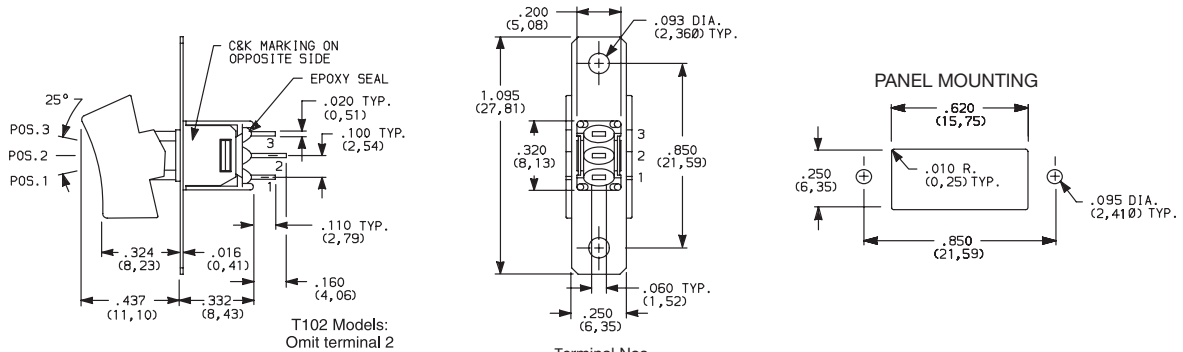

DP	<b>T201</b>	ON	NONE	ON	2-3,5-6	N/A	2-1,5-4	
	<b>T205</b>	MOM.	OFF	MOM.		OPEN		

**DPDT**

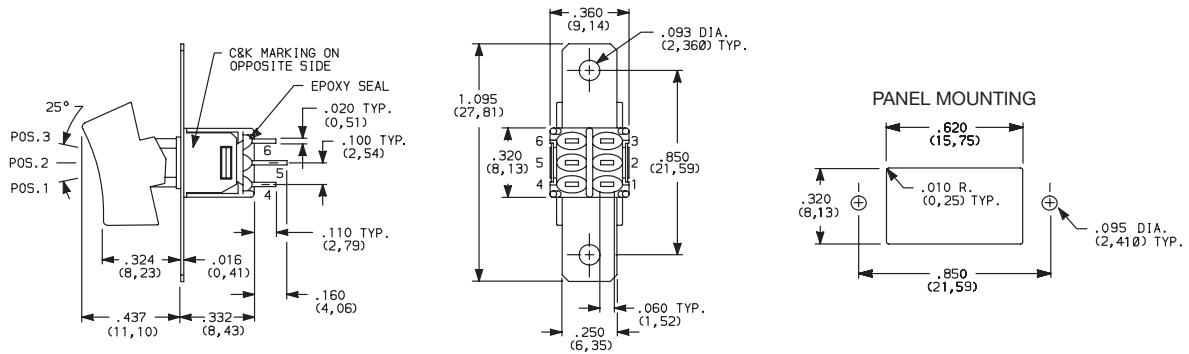

MOM. = Momentary

All models with all options when ordered with G, Q or R contact material.

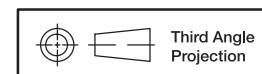

Dimensions are shown: Inches (mm)  
Specifications and dimensions subject to change



# T Series Subminiature Rocker Switches

## ACTUATOR

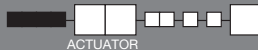

### J1 ROCKER, .300 WIDE

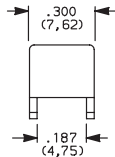
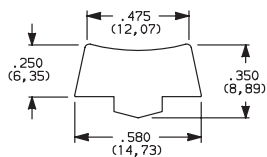

#### PANEL MOUNTING

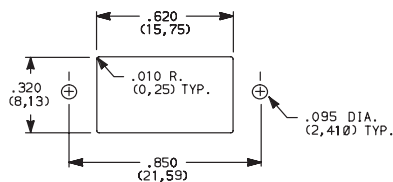

Standard with all models except T10X with A terminations.

### J6 ROCKER, .230 WIDE

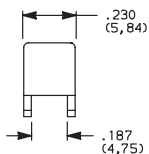
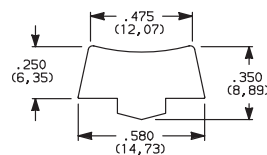

#### PANEL MOUNTING

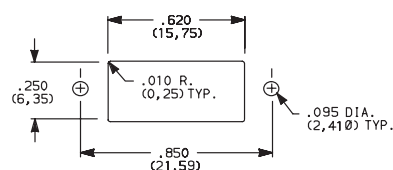

Standard with T10X model with A terminations.

OPTION CODE	ACTUATOR COLOR
<b>2</b>	<b>BLACK</b>

Actuators available separately, see page G 50. Finish: Matte. Other colors, custom actuator markings and legends available, consult Customer Service Center.

## TERMINATIONS



### Z SOLDER LUG

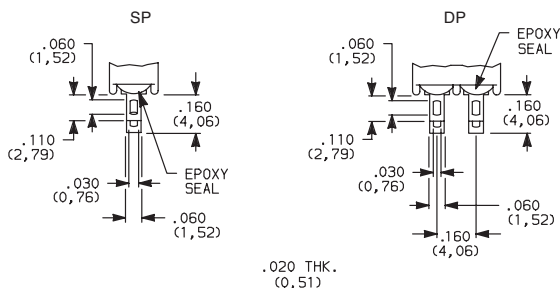

#### SP and DP

Not available with P or R contact material.

### A RIGHT ANGLE, PC THRU-HOLE

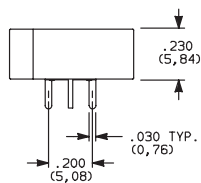

Actuator Shown In Pos. 1

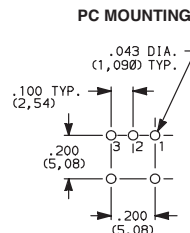
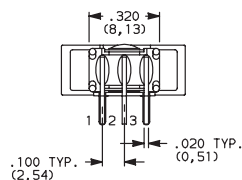
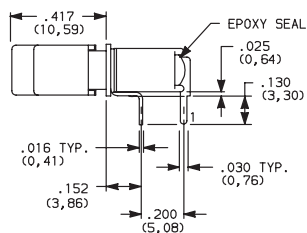

**T101J6ABE2**  
Horizontal Actuation  
SPDT

Not available with T102 model. J6 actuator standard only on T10X models with A terminations.

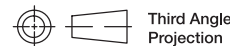

Third Angle  
Projection

Dimensions are shown: Inches (mm)  
Specifications and dimensions subject to change

Rocker

G

**C&K**



# T Series Subminiature Rocker Switches

## TERMINATIONS

### A RIGHT ANGLE, PC THRU-HOLE

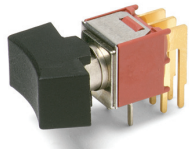

**T201J1ABE2**  
Horizontal Actuation  
**DPDT**

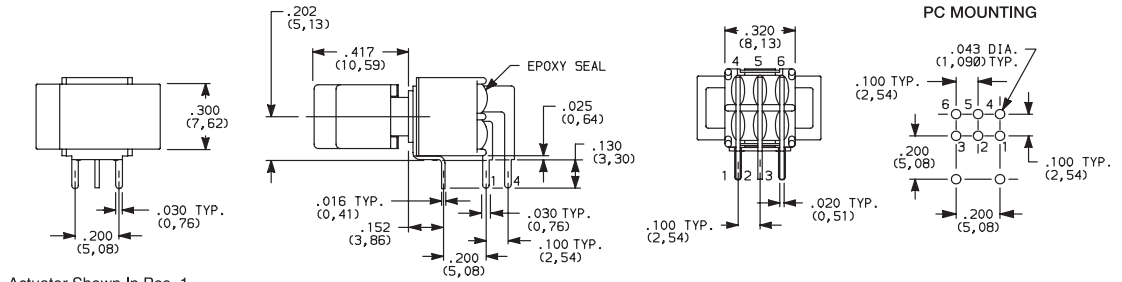

### AV VERTICAL RIGHT ANGLE, PC THRU-HOLE

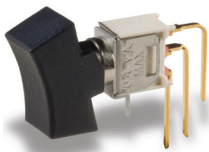

**T101J1AVBE2**  
Vertical Actuation  
**SPDT**

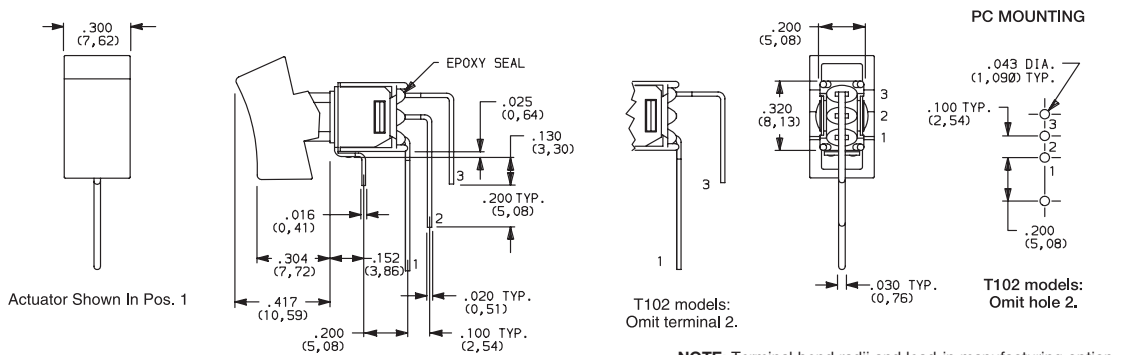

### AV VERTICAL RIGHT ANGLE, PC THRU-HOLE

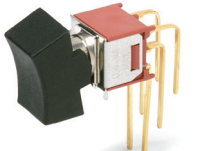

**T201J1AVBE2**  
Vertical Actuation  
**DPDT**

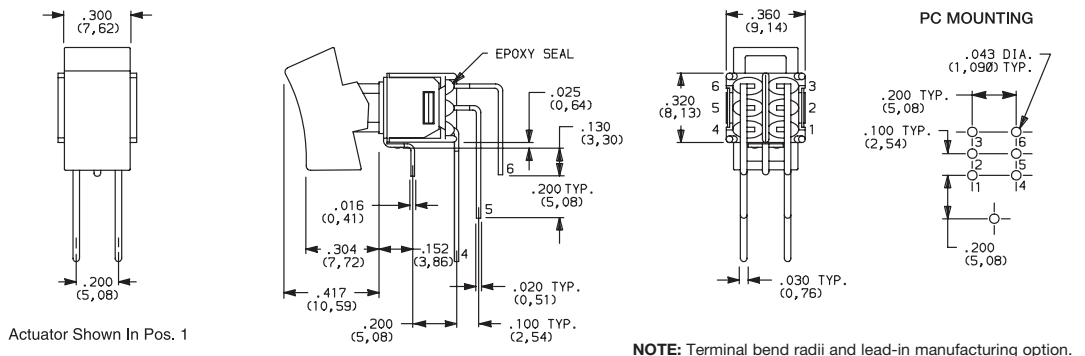

### V3 VERTICAL MOUNT, V-BRACKET



**T101J1V3BE2**  
**SPDT**

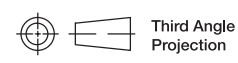
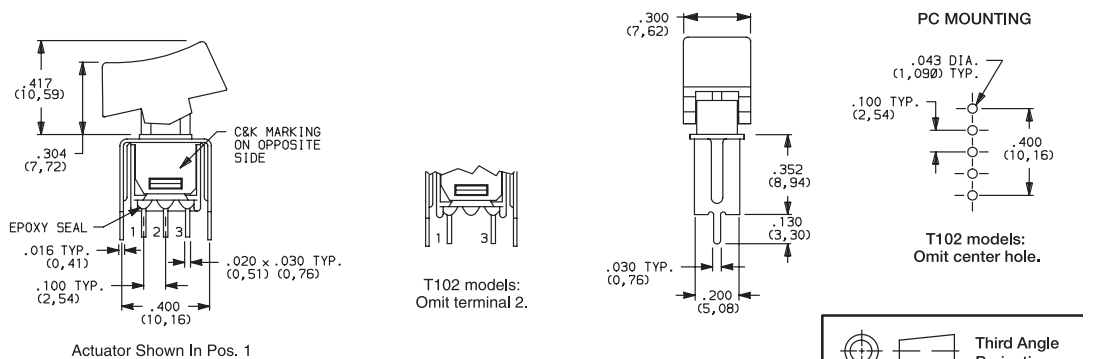

Dimensions are shown: Inches (mm)  
Specifications and dimensions subject to change



# T Series Subminiature Rocker Switches

## TERMINATIONS

### V3 VERTICAL MOUNT, V-BRACKET

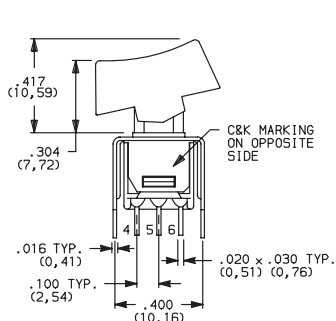

Actuator Shown In Pos. 1

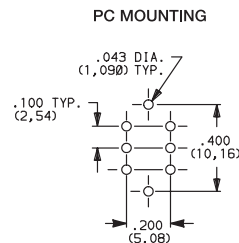
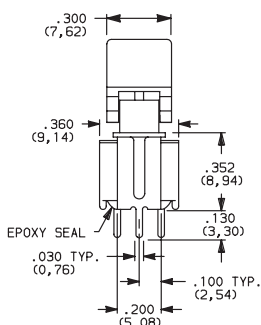

T201J1V3BE2  
DPDT

## CONTACT MATERIAL

OPTION CODE	CONTACT MATERIAL	TERMINAL PLATING	RATINGS	
<b>B</b>	GOLD <sup>3</sup>	GOLD <sup>1</sup>	LOW LEVEL/ DRY CIRCUIT	0.4 VA MAX. @ 20 V AC OR DC MAX.
<b>P</b>		MATTE-TIN <sup>6</sup>		
<b>Q</b>	SILVER <sup>4,5</sup>	SILVER <sup>5</sup>	POWER	TX01 MODELS: 3 AMPS @ 120 V AC OR 28 V DC. ALL OTHER MODELS: 2 AMPS @ 120 V AC OR 28 V DC.
<b>G</b>	GOLD OVER SILVER <sup>2,3</sup>	GOLD <sup>3</sup>	LOW LEVEL/DRY CIRCUIT OR POWER	TX01 MODELS: 0.4 VA MAX @ 20 V AC OR DC MAX. OR 3 AMPS @ 120 V AC OR 28 V DC. ALL OTHER MODELS: 0.4 VA MAX @ 20 V AC OR DC MAX. OR 2 AMPS @ 120 V AC OR 28 V DC.
<b>R</b>		MATTE-TIN <sup>6</sup>		

\* Note: See Technical Data section of this catalog for RoHS compliant and compatible definitions and specifications.

- 1 CONTACTS & TERMINALS: Copper alloy, with gold plate over nickel plate.
- 2 END CONTACTS: Coin silver, with gold plate over nickel plate.
- 3 CENTER CONTACTS & ALL TERMINALS: Copper alloy, with gold plate over nickel plate.
- 4 END CONTACTS: Coin silver, silver plated.
- 5 CENTER CONTACT & ALL TERMINALS: Copper alloy, silver plated.
- 6 TERMINALS: Copper alloy, with matte-tin over nickel plate.

**NOTE: Any models supplied with B, G, P, Q & R contact material are RoHS compliant.**

All models with all options when ordered with G, Q, or R contact material.

B contact material standard with A, AV, V3 terminations.

Q contact material standard with C & Z terminations.

**P & R contact materials not available with Z terminations.**

## SEAL

### E EPOXY SEAL

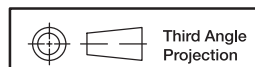
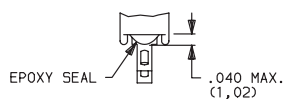

# T Series Subminiature Rocker Switches

## AVAILABLE HARDWARE

Panel mounting hardware for rocker and lever handle switches is available separately. Mounting hardware consists of two screws, two nuts, two standoffs and two lockwashers per switch, and is available for panel thicknesses of 1/16, 3/32 and 1/8 inch. See part numbers below.

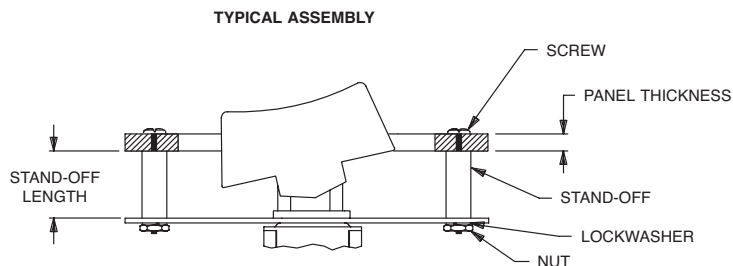

PART NO.	PANEL THK.	STANDOFF LENGTH
761101000	1/16 IN. (1,59)	.295 (7,49)
761102000	3/32 IN. (2,38)	.264 (6,71)
761103000	1/8 IN. (3,18)	.233 (5,92)

**NOTE:** Additional nuts, screws and lockwashers available separately, see Technical Data section of this catalog.

### J1 Actuator



PART NO.  
**468002263** BLACK

Material: Nylon  
Finish: Matte

### J6 Actuator



PART NO.  
**468102263** BLACK

Material: Nylon  
Finish: Matte

**NOTE:** Other colors, custom actuator markings and legends available, consult Customer Service Center.

# 9000 Series Power Rocker and Lever Handle Switches

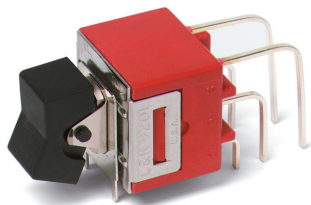

## Features/Benefits

- **Thermoset UL 94V-0 housing**
- **Rugged construction**
- **Variety of actuator and termination options**
- **RoHS compliant**

## Typical Applications

- **Small equipment**
- **Shut-off switch**

UL 61058-1



## Specifications

CONTACT RATING:

9201 Model:

- GP (general purpose)
- 6 AMPS 125 VAC 50/60 Hz T85 10,000 cycles (10E3)
- 3 AMPS 250 VAC 50/60 Hz T85 10,000 cycles
- R (resistive)
- 6 AMPS 30 VDC T85 10,000 cycles

9221 Model:

- GP (general purpose)
- 10 AMPS 125 VAC 50/60 Hz T85 10,000 cycles
- 5 AMPS 250 VAC 50/60 Hz T85 10,000 cycles
- R (resistive)
- 10 AMPS 30 VDC T85 10,000 cycles

ELECTRICAL LIFE: 25,000 make-and-break cycles at full load.

CONTACT RESISTANCE: Below 10 m Ω typ. initial @ 2–4 V DC, 100 mA.

INSULATION RESISTANCE: 10<sup>9</sup> Ω min.

DIELECTRIC STRENGTH: 2,500 Vrms min. @ sea level.

OPERATING TEMPERATURE: –30°C to 85°C.

SOLDERABILITY: Per MIL-STD-202F method 208D, or EIA RS-186E method 9 (1 hour steam aging).

## Materials

CASE: Diallyl phthalate (DAP) (UL 94V-0).

ACTUATOR: Nylon, black standard.

FRAME-REAR MOUNT OPTIONS: Spring steel, black.

BUSHING: Brass, nickel plated.

HOUSING: Stainless steel.

SWITCH SUPPORT: Brass or steel, matte-tin plated.

MOUNTING BRACKET: Stainless steel.

END CONTACTS: 9201 Model: Coin silver, silver plated.  
9221 Model: Silver cadmium oxide.

CENTER CONTACTS: Copper alloy, silver plated

ALL TERMINALS: 9201 Model: Copper alloy, silver plated.  
9221 Model: Copper alloy, matte-tin plated.

TERMINAL SEAL: Epoxy.

HARDWARE: Nut, Screw & Lockwasher: Stainless steel. Standoff: Nylon standard, aluminum available, consult Customer Service Center.

\*Cadmium used in electrical contacts is acceptable for RoHS.

**NOTE:** Any models supplied with Q contact material are RoHS compliant.

**NOTE:** Specifications and materials listed above are for switches with standard options. For information on specific and custom switches, consult Customer Service Center.

## Build-A-Switch

To order, simply select desired option from each category and place in the appropriate box. Available options are shown and described on pages G-52 through G-55. For additional options not shown in catalog, consult Customer Service Center.



### Switch Function

- 9201** DP On-On, 6 Amps
- 9221** DP On-On, 10 Amps

### Actuator

- J1** Rocker
- J2** Lever
- J3** Rocker
- J37** Rocker with metal frame

### Terminations

- Z** Solder lug (9201 only)
- AV2** Vertical right angle, PC thru-hole (9201 only)
- C** PC Thru-hole (9201 only)
- Z4** Quick connect

### Contact Material

- Q** Silver

### Seal

- E** Epoxy
- D** No Seal

### Actuator Color

- 2** Black
- 1** White
- 3** Red

### Frame Color

- 2** Black
- NONE** No frame color required

Rocker



G



Dimensions are shown: Inches (mm)

Specifications and dimensions subject to change

# 9000 Series Power Rocker and Lever Handle Switches

## SWITCH FUNCTION

NO. POLES	MODEL NO.	RATING*	SWITCH FUNCTION		CONNECTED TERMINALS		SCHEMATIC
			POS. 1	POS. 2	POS. 1	POS. 2	
DP	9201	6 AMPS	ON	ON	2-3,5-6	2-1,5-4	 DPDT
	9221	10 AMPS	ON	ON			

**DPDT**

Part number shown: 9201J1ZQE2

Terminal Nos. Molded On Side Of Case

All 9000 Series models meet international dimensional and electrical requirements.



\* See CONTACT MATERIAL, page G-54, for complete ratings.

9221 model must be ordered with Z4 terminations and D seal option.

## ACTUATOR-PANEL MOUNT

OPTION CODE	ACTUATOR COLOR
2	BLACK
1	WHITE
3	RED

Finish: Matte. Other colors, custom actuator markings and legends available, consult Customer Service Center.

**NOTE:** Hardware: two each—mounting screws, nuts, lockwashers and standoffs for 1/8 inch thick panel are supplied standard on all switches with panel mounting brackets. Actuators available separately, see page G-55. Hardware available separately, see Technical Data section of this catalog.

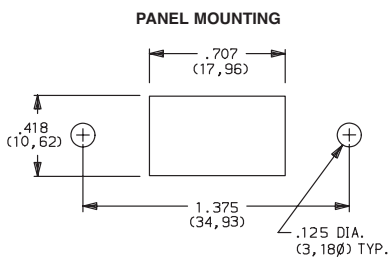

### J1 ROCKER

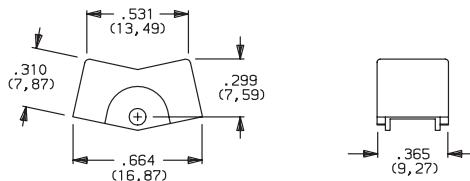

### J2 LEVER

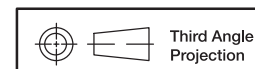
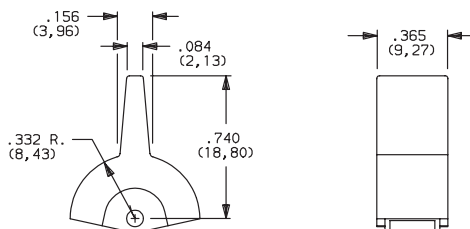

Dimensions are shown: Inches (mm)  
Specifications and dimensions subject to change



# 9000 Series Power Rocker and Lever Handle Switches

## ACTUATOR-PANEL MOUNT

ACTUATOR COLOR

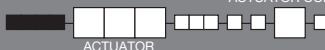

### J3 ROCKER

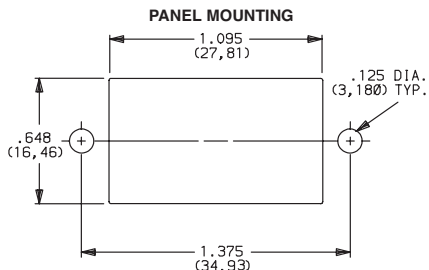
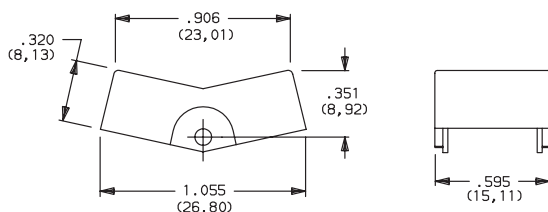

OPTION CODE	ACTUATOR COLOR
2	BLACK
1	WHITE
3	RED

Actuator finish: Matte. Other colors, custom actuator markings and legends available, consult Customer Service Center.

**NOTE:** Actuators available separately, see page G-55. Hardware: two each—mounting screws, nuts, lockwashers and standoffs for 1/8 inch thick panel are supplied standard on all switches with panel mounting brackets. Hardware available separately, see Technical Data section of this catalog.

## ACTUATOR-REAR MOUNT

ACTUATOR COLOR



### J37 ROCKER WITH METAL FRAME

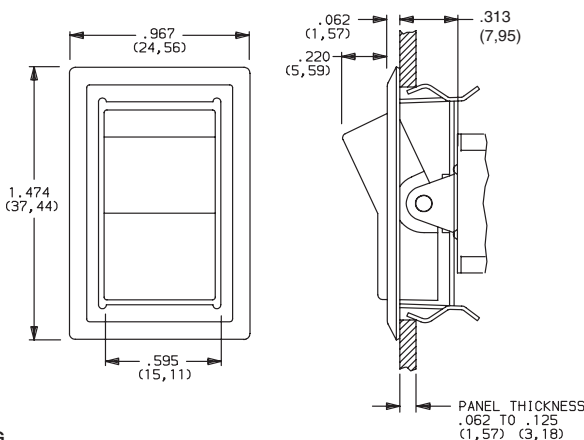
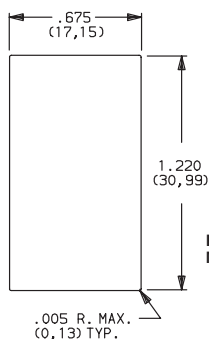

Not available with AV2 termination.

OPTION CODE	ACTUATOR COLOR
2	BLACK
1	WHITE
3	RED

OPTION CODE	FRAME COLOR
2	BLACK

Actuator finish: Matte. Frame finish: Gloss. Other colors, custom actuator markings and legends available, consult Customer Service Center.

**NOTE:** Actuators & frames available separately, see page G-55. Hardware: two each—mounting screws, nuts, lockwashers and standoffs for 1/8 inch thick panel are supplied standard on all switches with panel mounting brackets. Hardware available separately, see Technical Data section of this catalog.

## TERMINATIONS

### Z SOLDER LUG

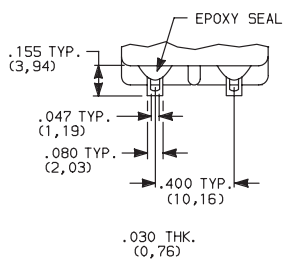

9201 Only

### C PC THRU-HOLE

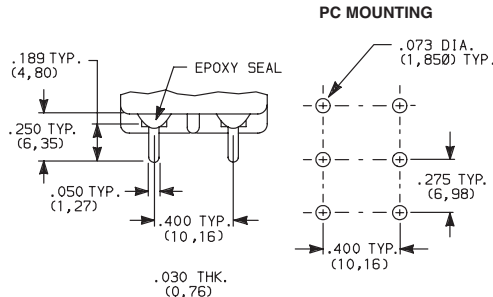

9201 Only

### Z4 QUICK CONNECT

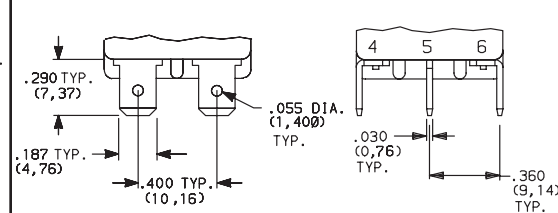

9201 and 9221

**NOTE:** Only termination available with 9221 model. Must be ordered with D seal option. Mating terminal standard Nema .187" quick connect.



Dimensions are shown: Inches (mm)  
Specifications and dimensions subject to change

Rocker

G

**C&K**

# 9000 Series Power Rocker and Lever Handle Switches

## TERMINATIONS

### AV2 VERTICAL RIGHT ANGLE, PC THRU-HOLE

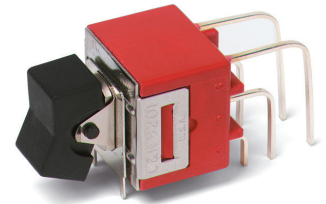
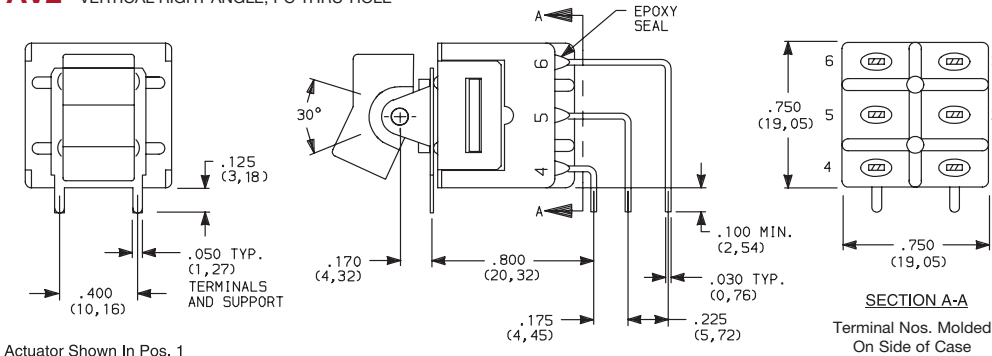

9201J1AV2QE2  
Vertical Actuation  
DPDT

Actuator Shown In Pos. 1

### PC MOUNTING

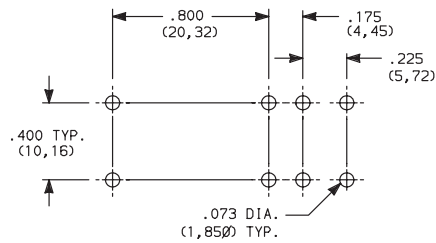

### 9201 Only

**NOTE:** Terminal bend radii and lead-in manufacturing option. Terminal spacing greater than 3mm at all points.

## CONTACT MATERIAL

OPTION CODE	MODEL	CONTACT MATERIAL	TERMINAL PLATING	RATINGS
Q	9201	SILVER 1,2	SILVER OR TIN 2,5	GP (general purpose) 6 AMPS 125 VAC 50/60 Hz T85 10,000 cycles (10E3) 3 AMPS 250 VAC 50/60 Hz T85 10,000 cycles R (resistive) 6 AMPS 30 VDC T85 10,000 cycles
	9221	SILVER CADMIUM OXIDE 3,4,6	TIN 5	GP (general purpose) 10 AMPS 125 VAC 50/60 Hz T85 10,000 cycles 5 AMPS 250 VAC 50/60 Hz T85 10,000 cycles R (resistive) 10 AMPS 30 VDC T85 10,000 cycles

\* Note: See Technical Data section of this catalog for RoHS compliant and compatible definitions and specifications.

- 1 END CONTACTS: Coin silver, silver plated.
- 2 CENTER CONTACTS & ALL TERMINALS: Copper alloy, silver plated.
- 3 END CONTACTS: Silver cadmium oxide.
- 4 CENTER CONTACTS: Copper alloy, silver plated.
- 5 Z4 TERMINALS ONLY: Copper alloy, tin plated.
- 6 Cadmium used for electrical contacts is acceptable for RoHS.

**NOTE:** Any models supplied with Q contact material is RoHS compliant.

9221 model must be ordered with Z4 terminations and D seal option.

All 9000 Series models meet international dimensional and electrical requirements.



## SEAL

### E EPOXY SEAL

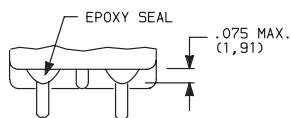

Not available with 9221 model or Z4 terminations.

### D NO EPOXY SEAL

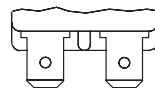

Must be ordered with 9221 model and Z4 termination.

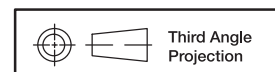

Dimensions are shown: Inches (mm)  
Specifications and dimensions subject to change



# 9000 Series Power Rocker and Lever Handle Switches

## AVAILABLE HARDWARE

Panel mounting hardware for rocker and lever handle switches is available separately. Mounting hardware consists of two screws, two nuts, two standoffs and two lockwashers per switch, and is available for panel thicknesses of 1/16, 3/32 and 1/8 inch. See part numbers below.

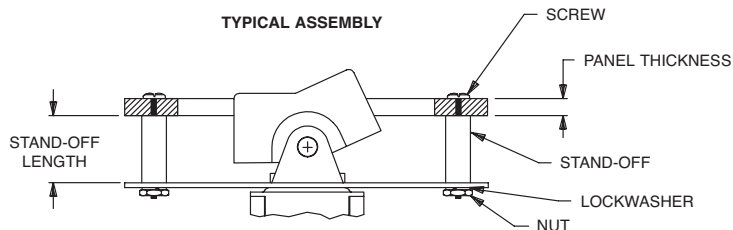

### J1 & J2 actuators

PART NO.	PANEL THK.	STANDOFF LENGTH
<b>761101000</b>	1/16 IN. (1,59)	.295 (7,49)
<b>761102000</b>	3/32 IN. (2,38)	.264 (6,71)
<b>761103000</b>	1/8 IN. (3,18)	.233 (5,92)

#### J1 Actuator



**PART NO.**  
**776A01000** WHITE  
**776A02263** BLACK  
**776A03000** RED

Material: Nylon  
 Finish: Matte

#### J2 Actuator



**PART NO.**  
**760501000** WHITE  
**760502263** BLACK  
**760503000** RED

Material: Nylon  
 Finish: Matte

#### J3, J37 Actuators



**PART NO.**  
**766601000** WHITE  
**766602263** BLACK  
**766603000** RED

Material: Nylon  
 Finish: Matte

#### Frame for J37 Actuators



**PART NO.**  
**445400746** BLACK ENAMEL  
 Material: Spring Steel

**NOTE:** Additional nuts, screws and lockwashers available separately, see Technical Data section of this catalog.

Other colors available, consult Customer Service Center.

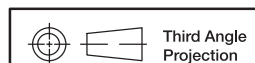



# DA Series Miniature Single Pole Rocker Switches

## Features/Benefits

- Nice actuator styling with multiple options
- Guards to prevent accidental actuation
- Momentary and maintained functions
- IP54 splash proof rubber boot option
- RoHS compliant

## Typical Applications

- Small appliances
- Computers and peripherals
- Medical instrumentation



**UL** **61058-1**

## Specifications

### CONTACT RATING:

- 16 AMPS @ 125 VAC, 1/3 HP;
- 10 AMPS @ 250 VAC, 1/2 HP.
- 10 AMPS @ 125 VAC, 6 AMPS @ 250 VAC.

ELECTRICAL LIFE: 10,000 make and break cycles at full load.

INSULATION RESISTANCE:  $10^8 \Omega$  min.

DIELECTRIC STRENGTH: 1,500 VRMS @ sea level.

OPERATING TEMPERATURE: -20°C to +85°C

## Materials

HOUSING AND ACTUATOR: 6/6 nylon (UL94V-2), black, matte finish.

ILLUMINATED ACTUATOR: Polycarbonate, matte finish.

CENTER CONTACTS: Silver plated, copper alloy.

END CONTACTS: Silver plated.

ALL TERMINALS: Silver plated, copper alloy.

**NOTE:** Specifications and materials listed above are for switches with standard options. For information on specific and custom switches, consult Customer Service Center.

## Build-A-Switch

To order, simply select desired option from each category and place in the appropriate box. Available options are shown and described on pages G-57 through G-60. For additional options not shown in catalog, consult Customer Service Center.

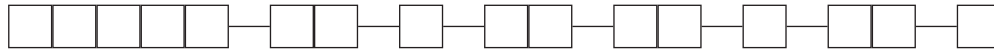

### Switch Function

- DA101** SPDT On-None-On
- DA102** SPST On-None-Off
- DA103** SPDT On-Off-On

### Actuator

- J1** Rocker
- J2** Two-tone rocker
- \*, \*\*J3** Illuminated rocker
- \*\* J4** Circle, illuminated rocker
- \*\* J5** Oval, illuminated rocker

### Actuator Color

- 1-5** See Chart on Page G-59
- \*R** Red, illuminated
- \*A** Amber, illuminated
- \*G** Green, illuminated

\* Actuator "J3" illuminated switches are not available with actuator markings

\*\* Actuator "J3", "J4" and "J5" are not available with Termination option "17" solder lug

### Mounting Style/Color

- S2** Snap-in, black
- S1** Snap-in, white
- B2** Recessed snap-in bracket, black
- G2** Guard, black

### Termination

- 15** .187" quick connect
- 17** Solder lug
- 02** Thru-hole
- A** Right angle

### Actuator Marking

- (NONE)** No marking
- D** ON-OFF
- H** "O I" - international ON-OFF
- N** Large dot
- P** "O -" international ON-OFF

### Contact Rating

- QF** Silver

### Lamp Rating

- (NONE)** No lamp
- 6** LED
- 7** 125 VAC neon
- 8** 250 VAC neon

# DA Series Miniature Single Pole Rocker Switches

## SWITCH FUNCTION



NO. POLES	MODEL NO.	SWITCH FUNCTION			CONNECTED TERMINALS			SCHEMATIC
		C&K marking on opposite side			C&K marking on opposite side			
SP	<b>DA101</b>	ON	NONE	ON	2-3	N/A	2-1	
	<b>DA102</b>	ON	NONE	OFF				 OR For 7 & 8 Illuminated Versions Only
	<b>DA103</b>	ON	OFF	ON				 For 6 Illuminated Versions Only

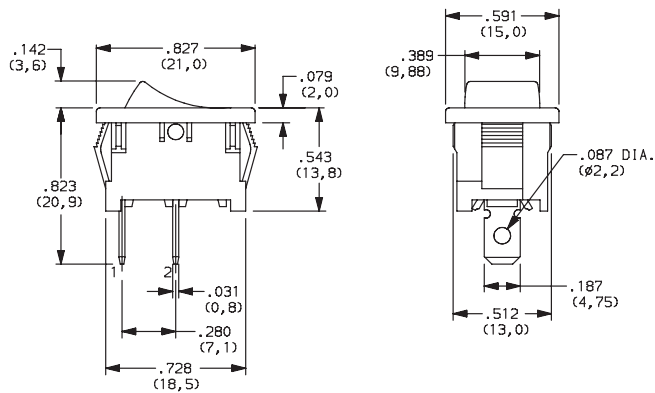

Shown in Pos. 1

## ACTUATOR

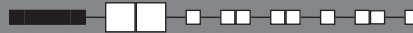

### J1 ROCKER

### \*J3 ILLUMINATED ROCKER

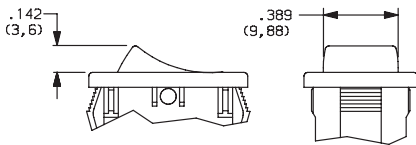

**NOTE:** J3 actuator available with DA102 switch functions, 7&8 lamp ratings and not available with O2 and A termination options.

\* J3 actuator not available with markings or Termination option "17" solder lug

### J2 TWO-TONE ROCKER

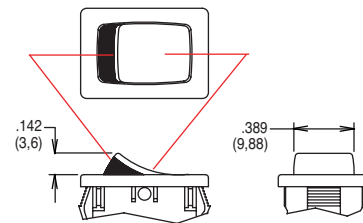

**NOTE:**

1. Available with DA102 switch function only.
2. Available with None or P actuator marking options only.

Rocker

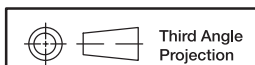

Third Angle  
Projection

Dimensions are shown: Inches (mm)  
Specifications and dimensions subject to change



15 May 20

# DA Series Miniature Single Pole Rocker Switches

## ACTUATOR

### J4 CIRCLE, ILLUMINATED ROCKER

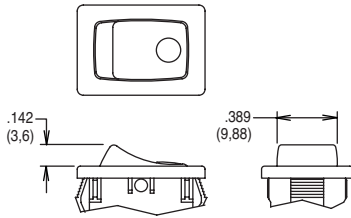

**NOTE:** Available with DA102 switch function and 7 & 8 lamp ratings combinations only. Not available with O2 and A termination options. \* J4 actuator not available with Termination option "17" solder lug

### J5 OVAL, ILLUMINATED ROCKER

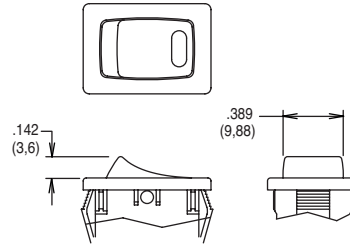

**NOTE:** Available with DA102 switch function and 6 lamp rating combinations only. Not available with O2 and A termination options. \* J5 actuator not available with Termination option "17" solder lug

## ACTUATOR COLOR

	OPTION CODE	ACTUATOR COLOR
<b>J1 only</b>	<b>2</b>	BLACK
	<b>1</b>	WHITE
	<b>3</b>	RED
<b>J3, J4, J5 only</b>	<b>R</b>	RED, ILLUMINATED
	<b>A</b>	AMBER, ILLUMINATED
	<b>G</b>	GREEN, ILLUMINATED

	OPTION CODE	ACTUATOR COLOR TOP	ACTUATOR COLOR BOTTOM
<b>J2 only</b>	<b>1</b>	WHITE	RED
	<b>2</b>	WHITE	BLACK
	<b>3</b>	RED	WHITE
	<b>4</b>	BLACK	WHITE
	<b>5</b>	BLACK	RED

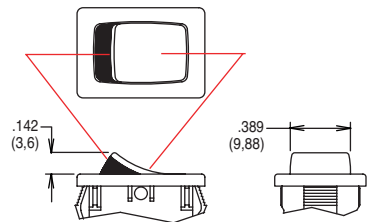

## MOUNTING STYLE/COLOR

### S2 SNAP-IN, BLACK

### S1 SNAP-IN, WHITE

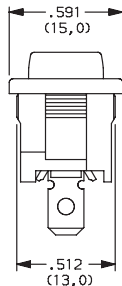
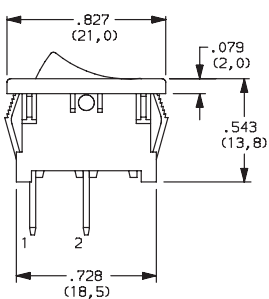

### G2 GUARD, BLACK

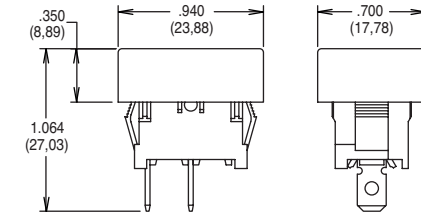

**NOTE:** Available with DA10X switch functions only.

### S2, S1 & G2 PANEL MOUNTING

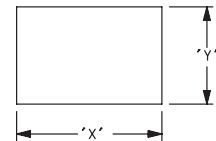

PANEL THICKNESS	"X"	"Y"
0.030-0.049 (0,75-1,25)	0.756-.004 (19,2-0,1)	0.512+.004 (13,0+0,1)
0.049-0.079 (1,25-2,0)	0.764-.004 (19,4-0,1)	0.512+.004 (13,0+0,1)
0.079-0.118 (2,0-3,0)	0.779-.004 (19,8-0,1)	0.512+.004 (13,0+0,1)

Actuator shown in Pos. 1

### B2 RECESSED SNAP-IN BRACKET, BLACK

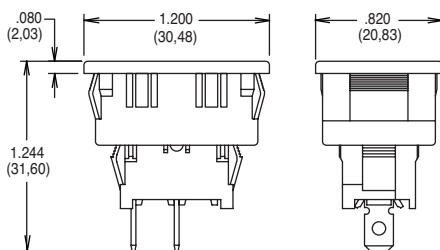

**NOTE:** Available with DA10X switch functions only.

### B2 PANEL MOUNTING

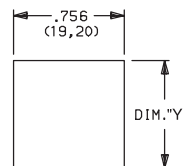

PANEL THICKNESS	"Y"
0.030-0.049 (0,75-0,25)	1.068 (27,13)
0.049-0.079 (1,25-2,0)	1.076 (27,33)
0.079-0.118 (2,0-3,0)	1.092 (27,74)



Dimensions are shown: Inches (mm)  
Specifications and dimensions subject to change



# DA Series Miniature Single Pole Rocker Switches

## TERMINATION

### 15 .187" QUICK CONNECT

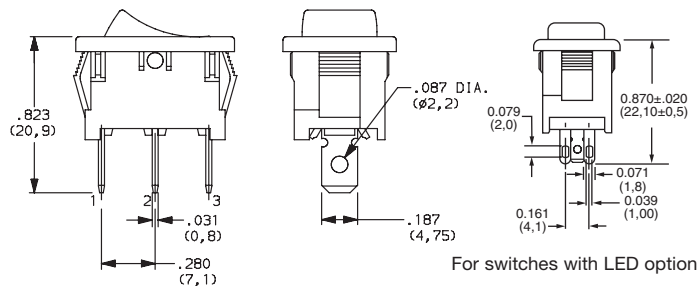

### 17 SOLDER LUG

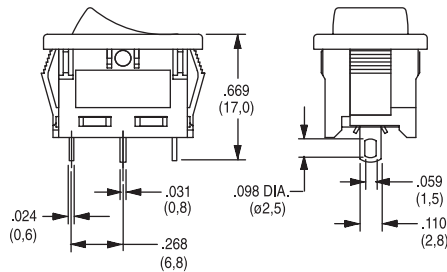

### 02\* THRU-HOLE

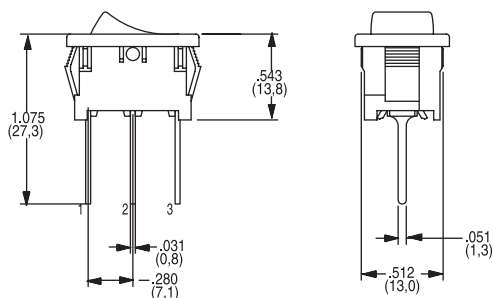

### A\* RIGHT ANGLE

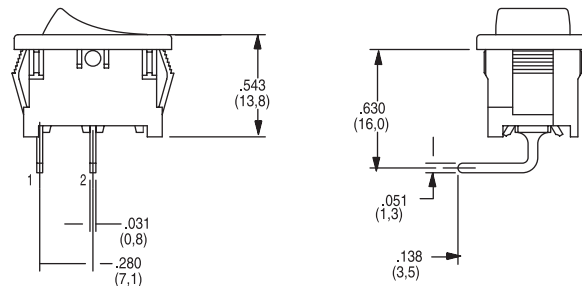

\* NOTE - O2 and A termination options not offered with J3, J4 or J5 actuator options.

## ACTUATOR MARKING

### NONE NO MARKING

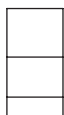

### D ON-OFF



### H O I

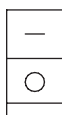

### N LARGE DOT



### P O -

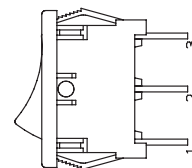

All models shown in Pos. 1  
Markings not available with J3 actuator

NOTE: Orientation of actuator marking and terminals.

## CONTACT MATERIAL

OPTION CODE	CONTACT AND TERMINAL MATERIAL	RATINGS	
QF	SILVER	POWER	16 AMPS @ 125 VAC; 1/3 HP; 10 AMPS @ 250 VAC; 1/2 10 AMPS @ 125 VAC, 6 AMPS @ 250 VAC

\* Note: See Technical Data section of this catalog for RoHS compliant and compatible definitions and specifications.

## LAMP RATING

- (NONE) NO LAMP
- 6 LED RATING @ 10 mA  $V_f=1.85V$
- 7 125 VAC 33kΩ NEON
- 8 250 VAC 150kΩ NEON

## ACCESSORIES

### 216C00000 IP54 SPLASH PROOF RUBBER BOOT

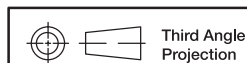
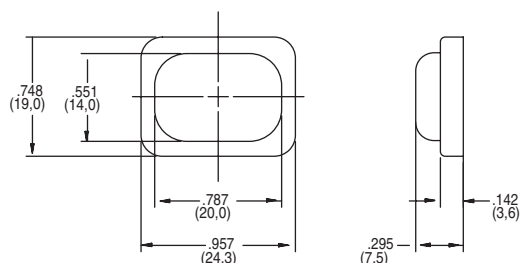

Dimensions are shown: Inches (mm)  
Specifications and dimensions subject to change

# D Series Miniature Snap-in Power Rocker Switches

## Features/Benefits

- Momentary and maintained models
- PC and quick connect terminals
- Recessed bracket available — prevents accidental actuation
- RoHS compliant
- Gold plated options available

## Typical Applications

- Small appliances
- Computers and peripherals
- Medical instrumentation

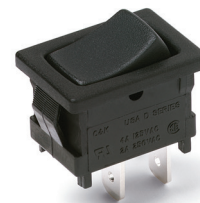

UL 61058-1



## Specifications

CONTACT RATING:

D101, D102, D103, D105, D108, D201, D202, D203

GP (general purpose)

4 AMPS 125 VAC 50/60 Hz T85 10,000 cycles

2 AMPS 250 VAC 50/60 Hz T85 10,000 cycles

R (resistive)

4 AMPS 30 VDC T85 10,000 cycles

D501, D502, D503, D508, D601, D602, D608

GP (general purpose)

10 AMPS 125 VAC 50/60 Hz T85 10,000 cycles

5 AMPS 250 VAC 50/60 Hz T85 10,000 cycles

R (resistive)

10 AMPS 30 VDC T85 10,000 cycles

0.4VA @ 20V AC/DC (gold plating) available upon request

ELECTRICAL LIFE: 10,000 make-and-break cycles at full load.

INSULATION RESISTANCE:  $10^9 \Omega$  min.

DIELECTRIC STRENGTH: 1,000 Vrms min. @ sea level.

## Materials

ACTUATOR & HOUSING: 6/6 nylon (UL 94V-2), color black, finish: matte.

MOVABLE CONTACTS: D10X and D20X Models: Copper, silver plated. D50X and D60X Models: Coin silver, silver plated.

STATIONARY CONTACTS AND TERMINALS: Copper or brass, silver plated. Gold plating available.

CONTACT SPRING: Music wire or stainless steel.

OPERATING TEMPERATURE: -30°C to +65°C

**NOTE:** Specifications and materials listed above are for standard switches. For information on specific and custom switches, consult Customer Service Center.

## Build-A-Switch

To order, simply select desired option from each category and place in the appropriate box. Available options are shown and described on pages G-61 through G-65. For additional options not shown in catalog, consult Customer Service Center.



### Switch Function

- D101** SPDT, On-None-On
- D102** SPST, On-None-Off
- D103** SPDT, On-Off-On
- D105** SPDT, Mom.-Off-Mom.
- D108** SPDT, Mom.-None-On
- D201** DPDT, On-None-On
- D202** DPST, On-None-Off
- D203** DPDT, On-Off-On
- D501** SPDT, On-None-On
- D502** SPST, On-None-Off
- D503** SPDT, On-Off-On
- D508** SPDT, Mom.-None-On
- D601** DPDT, On-None-On
- D602** DPST, On-None-Off
- D608** DPDT, Mom.-None-On

### Actuator

- J1** Rocker
- J5** Lever

### Actuator Color

- 2** Black
- 1** White
- 3** Red

### Mounting Style/Color

- S2** Snap-in, black
- B2** Recessed snap-in actuator guard, black
- G2** Actuator guard, black
- S1** Snap-in, white

### Terminations

- 15** Quick connect
- A** Right angle, PC thru-hole
- 02** PC Thru-hole
- 05** Twisted quick connect
- 06** Extended PC thru-hole
- 17** Wirable quick connect

### Actuator Markings

- NONE** No marking
- D** ON-OFF
- H** O I
- N** Large dot
- P** O -
- R** Red rectangle on end
- U** Large dot on end

### Contact Material

- QA** Silver
- Gold plating options available contact Customer Service



15 May 20



# D Series Miniature Snap-in Power Rocker Switches

## SWITCH FUNCTION

NO. POLES	MODEL NO.	AMP RATING*	SWITCH FUNCTION			CONNECTED TERMINALS			SCHEMATIC		
			POS. 1	POS. 2	POS. 3	POS. 1	POS. 2	POS. 3			
SP	<b>D102</b>	4	ON	NONE	OFF	1-1A	N/A	OPEN			
	<b>D502</b>	10									
	<b>D101</b>	4	ON	NONE	ON			1-1B	N/A		
	<b>D501</b>	10									
	<b>D103</b>	4		OFF							
	<b>D503</b>	10									
<b>D105</b>	4	MOM.	OFF	MOM.							
<b>D108</b>	4	MOM.	NONE	ON							
	<b>D508</b>	10									

### SPDT

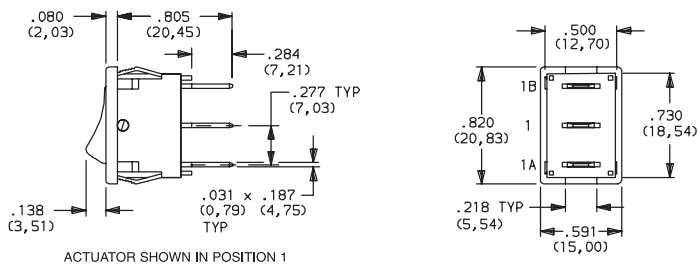

ACTUATOR SHOWN IN POSITION 1

TERMINAL NOS. FOR REF. ONLY

Part number shown: D101J12S215QA

DP	<b>D202</b>	4	ON	NONE	OFF	1-1A, 2-2A	N/A	OPEN			
	<b>D602</b>	10									
	<b>D201</b>	4	ON	NONE	ON			1-1B, 2-2B	N/A		
	<b>D601</b>	10									
	<b>D203</b>	4		OFF							
	<b>D603</b>	10									
<b>D608</b>	10	MOM.	NONE								

### DPDT

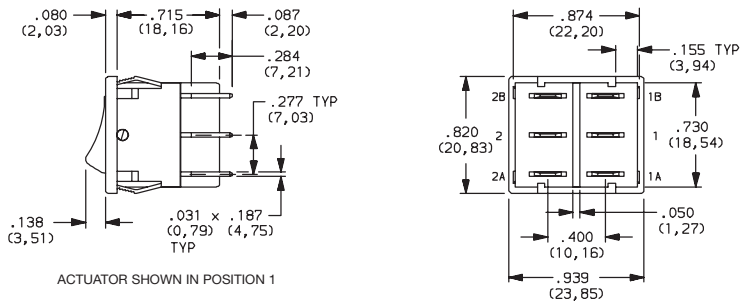

ACTUATOR SHOWN IN POSITION 1

TERMINAL NOS. FOR REF. ONLY

Part number shown: D201J12S215QA

MOM. = Momentary

\*AMP RATING: see G-60

See CONTACT MATERIALS, page G-64.



Rocker

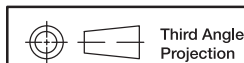

Third Angle Projection

Dimensions are shown: Inches (mm)  
Specifications and dimensions subject to change



15 May 20

# D Series Miniature Snap-in Power Rocker Switches



## J1 ROCKER

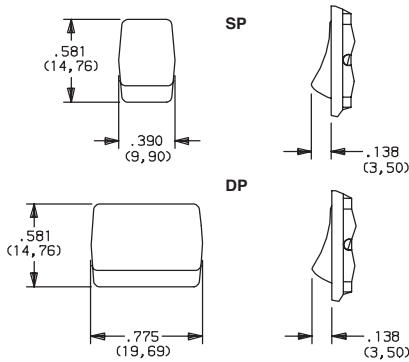

## J5 LEVER

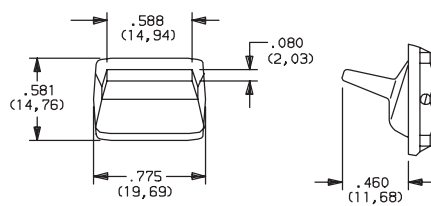

OPTION CODE	ACTUATOR COLOR
2	BLACK
1	WHITE
3	RED

**NOTE:** Actuator finish: matte. Other colors available, consult Customer Service Center.

'J5' actuator available only with DP models D201, D202, D601 and D602.

## MOUNTING STYLE/COLOR

### S SNAP-IN

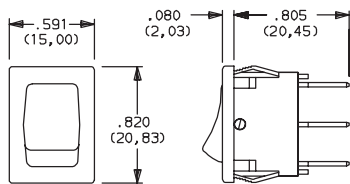

OPTION CODE	HOUSING COLOR
2	(STD.) BLACK
1	WHITE

**NOTE:** Frame finish on housing: matte. Other colors available, consult Customer Service Center.

### B2 RECESSED SNAP-IN ACTUATOR GUARD, BLACK

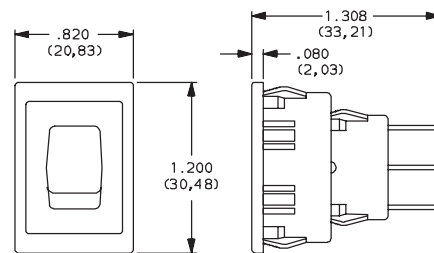

**NOTE:** Vertical mount, SP models only.

### G2 ACTUATOR GUARD, BLACK

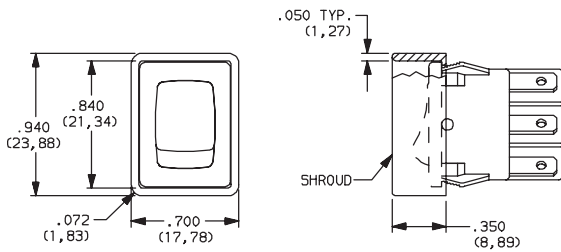

**NOTE:** Vertical mount, SP models only.

### PANEL MOUNTING

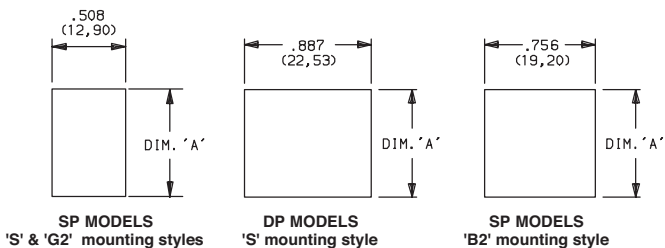

PANEL THICKNESS	DIM 'A' SP & DP MODELS 'S' MOUNTING STYLE	DIM 'A' WITH 'G2' OPTION SP MODELS ONLY	DIM 'A' SP MODELS 'B' MOUNTING STYLE
.030-.049 (0,76) (1,24)	.756 (19,20)	.764 (19,41)	1.068 (27,13)
.049-.079 (1,24) (2,01)	.764 (19,41)	.780 (19,81)	1.076 (27,33)
.079-.118 (2,01) (3,00)	.780 (19,81)	n/a	1.092 (27,74)

**NOTE:** Blank insert available for SP models only, see page G-64.

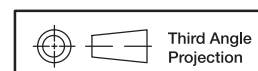

Dimensions are shown: Inches (mm)  
Specifications and dimensions subject to change



15 May 20



# D Series Miniature Snap-in Power Rocker Switches

## TERMINATIONS

### A RIGHT ANGLE, PC THRU-HOLE

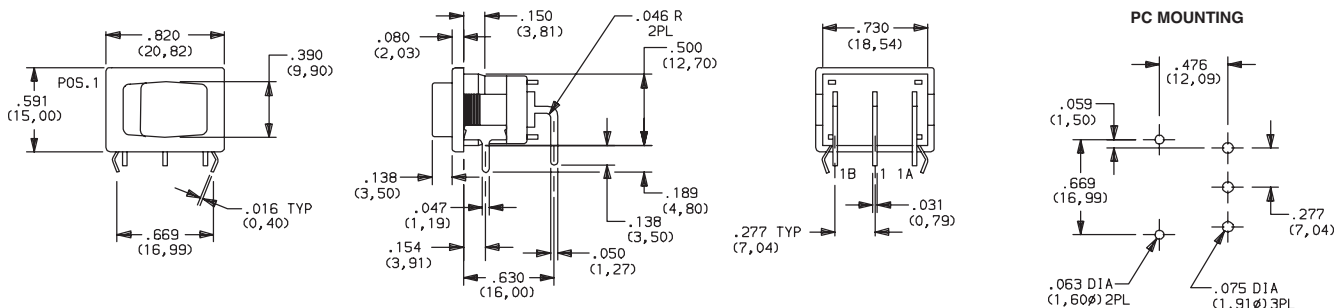

Available with D101, D102, D501, D502 SP models only.

## TERMINATIONS

### 02 PC THRU-HOLE

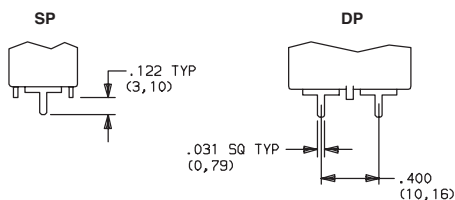

### 06 EXTENDED PC THRU-HOLE

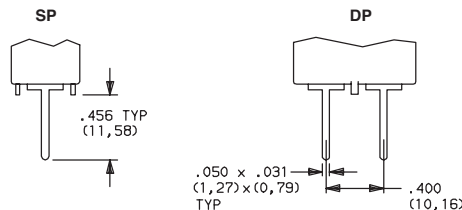

### PC MOUNTING (02 and 06)

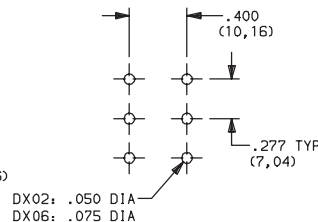

Available with DX01 and DX02 models only.

Available with DX01 and DX02 models only.

### 15 QUICK CONNECT

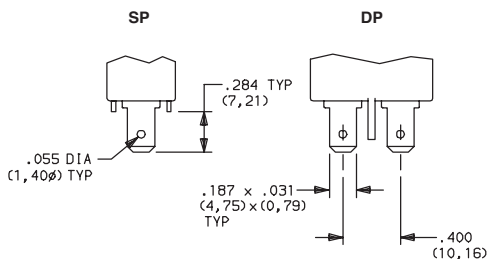

### 05 TWISTED QUICK CONNECT

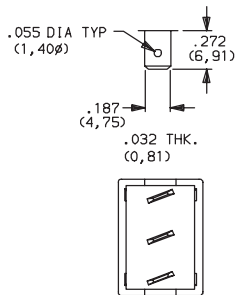

### 17 WIRABLE QUICK CONNECT

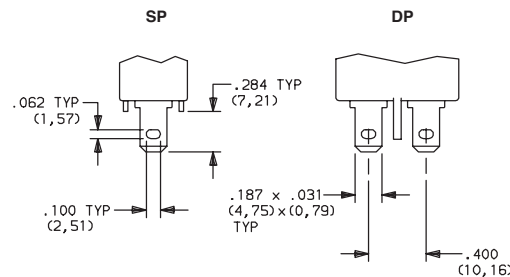

Available with DX01 and DX02 models only.

NOTE: Terminals are twisted.

Available with DX01 and DX02 models only.

## ACTUATORS

**NONE** NO MARKING

**D** ON-OFF

**H** O |

**N** LARGE DOT

**P** O -

**R** RED RECTANGLE ON END

**U** LARGE DOT ON END

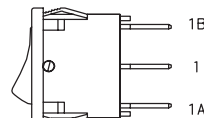

NOTE: Orientation of actuator markings and terminals.

'D, H, P & U' marking options: marking color white, standard for all actuator colors except white. Black marking color, standard for white actuators. 'R & N' marking option: red marking color, standard. Consult Customer Service Center for other available marking colors.



Dimensions are shown: Inches (mm)  
Specifications and dimensions subject to change

Rocker



15 May 20



# D Series Miniature Snap-in Power Rocker Switches

## CONTACT MATERIAL

OPTION CODE	CONTACT AND TERMINAL MATERIAL	RATINGS
<b>QA</b>	SILVER 1	D101, D102, D103, D105, D108, D201, D202, D203
		GP (general purpose) 4 AMPS 125 VAC 50/60 Hz T85 10,000 cycles
		2 AMPS 250 VAC 50/60 Hz T85 10,000 cycles
		R (resistive) 4 AMPS 30 VDC T85 10,000 cycles
		D501, D502, D503, D508, D601, D602, D608
		GP (general purpose) 10 AMPS 125 VAC 50/60 Hz T85 10,000 cycles
		5 AMPS 250 VAC 50/60 Hz T85 10,000 cycles
		R (resistive) 10 AMPS 30 VDC T85 10,000 cycles

<sup>1</sup>MOVABLE CONTACT: D10X and D20X MODELS: Copper, silver plated.  
D50X and D60X MODELS: Coin silver, silver plated.



0.4VA @ 20V AC/DC Gold plated options available contact Customer Service.

STATIONARY CONTACTS & TERMINALS: Copper or brass, silver plated.

## AVAILABLE HARDWARE

Insert  
SP Only

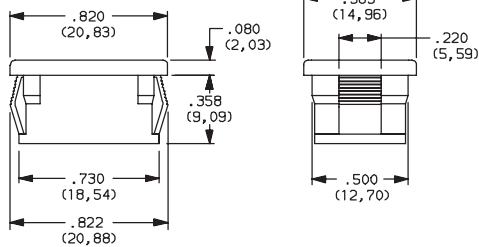

**PART NO.**  
**057190200** BLACK  
Material: Nylon 6/6  
Finish: Matte

Recessed Actuator Guard,  
SP Only

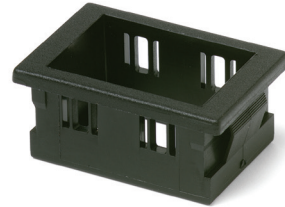

**599D02000** BLACK  
Material: 6/6 Nylon  
Finish: Matte

Actuator Guard

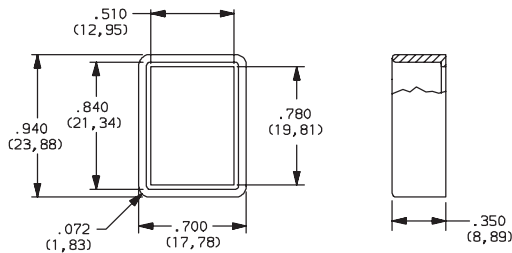

**PART NO.**  
**104C22000**  
Material: PBT thermoplastic  
Finish: Matte

**PART NO.**  
**216C00000** IP54 SPLASH PROOF RUBBER BOOT

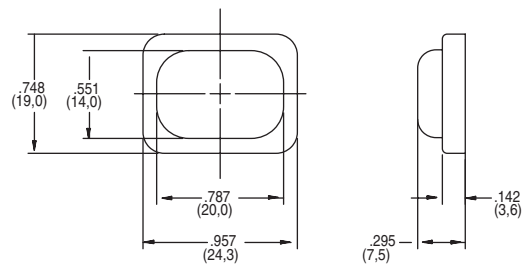

15 May 20

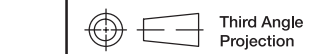

Dimensions are shown: Inches (mm)  
Specifications and dimensions subject to change



# DM Series Miniature 2 Pole Power Rocker Switches

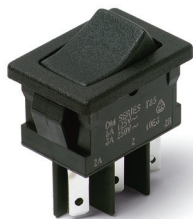

## Features/Benefits

- 3 AMPS to 10 AMPS
- Quick connect terminals
- Double pole in miniature size
- Recessed bracket available—prevents accidental actuation
- RoHS compliant

## Typical Applications

- Computers
- Appliances
- Electric tools

UL 61058-1



## Specifications

CONTACT RATING:

DM21, DM22:

GP (general purpose)

3 AMPS 125 VAC 50/60 Hz T85 10,000 cycles

2 AMPS 250 VAC 50/60 Hz T85 10,000 cycles

R (resistive)

3 AMPS 30 VDC T85 10,000 cycles

DM61, DM62:

GP (general purpose)

10 AMPS 125 VAC 50/60 Hz T85 10,000 cycles

5 AMPS 250 VAC 50/60 Hz T85 10,000 cycles

R (resistive)

10 AMPS 30 VDC T85 10,000 cycles

ELECTRICAL LIFE: 10,000 make-and-break cycles at full load.

INSULATION RESISTANCE:  $10^9 \Omega$  min.

DIELECTRIC STRENGTH: 1,000 Vrms min. @ sea level.

OPERATING TEMPERATURE: -20°C to +65°C

## Materials

HOUSING & ACTUATOR: 6/6 nylon (UL94V-2), black.

MOVABLE CONTACTS: DM2X Models: Copper, silver plated.

DM6X Models: Coin silver, silver plated.

STATIONARY CONTACTS & TERMINALS: Copper or brass, silver plated.

CONTACT SPRING: Music wire or stainless steel.

**NOTE:** Any models supplied with Q contact material are RoHS compliant.

**NOTE:** Specifications and materials listed above are for standard switches. For information on specific and custom switches, consult Customer Service Center.

## Build-A-Switch

To order, simply select desired option from each category and place in the appropriate box. Available options are shown and described on pages G-66 and G-69. For additional options not shown in catalog, consult Customer Service Center.

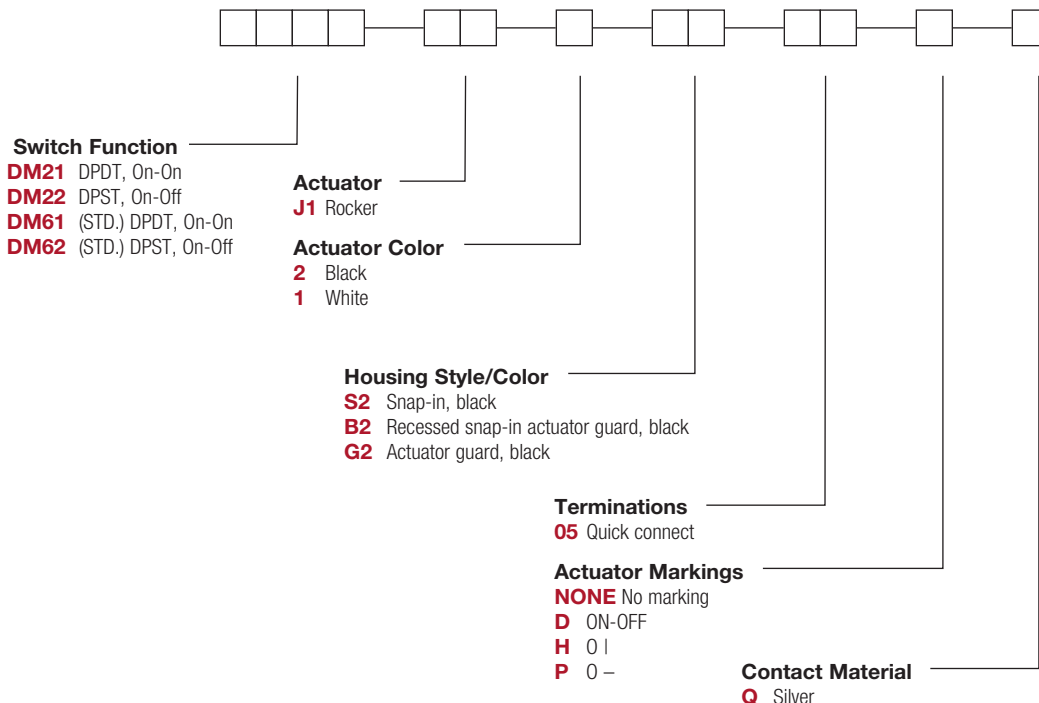

# DM Series Miniature 2 Pole Power Rocker Switches

## SWITCH FUNCTION



NO. POLES	MODEL NO.	AMP RATING*	SWITCH FUNCTION		CONNECTED TERMINALS		SCHEMATIC
			POS. 1	POS. 2	POS. 1	POS. 2	
DP	<b>DM22</b>	3	ON	OFF	1-1A, 2-2A	OPEN	
	<b>DM62</b>	10	ON	OFF	1-1A, 2-2A	OPEN	
	<b>DM21</b>	3	ON	ON	1-1A, 2-2A	1-1B, 2-2B	
	<b>DM61</b>	10	ON	ON	1-1A, 2-2A	1-1B, 2-2B	

**DPDT**

PART NUMBER SHOWN: DM21J1XS205Q

NOTES 1. ACTUATOR SHOWN IN POSITION 1-'ON' POSITION

RATINGS: See page G-65 for complete ratings.



UL 61058-1 tested to 30C temperature rise @ 6,000 cycles.

## ACTUATOR

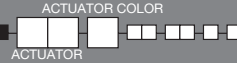

### J1 ROCKER

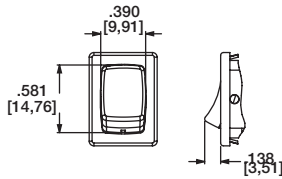

OPTION CODE	ACTUATOR COLOR
<b>2</b>	BLACK
<b>1</b>	WHITE

**NOTE:** Actuator finish: matte. Other colors available, consult Customer Service Center.

## HOUSING STYLE/COLOR



### S2 SNAP-IN, BLACK

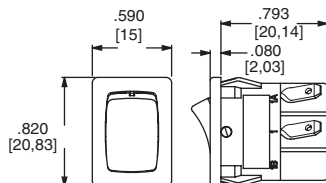

**NOTE:** Housing finish: matte. Other colors available, consult Customer Service Center.

### B2 RECESSED SNAP-IN ACTUATOR GUARD, BLACK

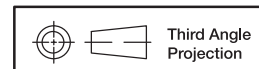
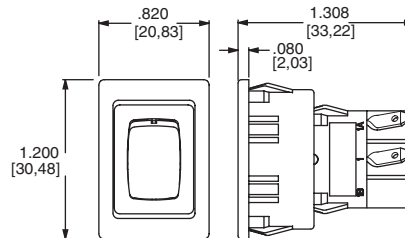

Dimensions are shown: Inches (mm)  
Specifications and dimensions subject to change



15 May 20



# DM Series Miniature 2 Pole Power Rocker Switches

## HOUSING STYLE/COLOR

**G2** ACTUATOR GUARD, BLACK

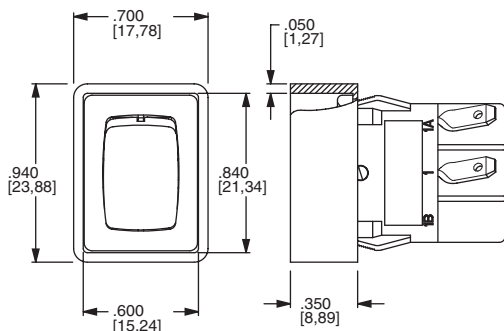

### PANEL MOUNTING

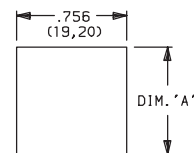
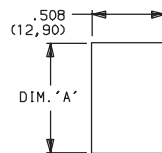

'S2' & 'G2' housing styles

'B2' housing style

NOTE: Blank insert available for SP models only, see page H-76.

PANEL THICKNESS	DIM 'A' 'S2' & 'G2' HOUSING STYLES	DIM 'A' 'G2' OPTION SP MODELS ONLY	DIM 'A' 'B2' HOUSING STYLES
.030-.049 (0,76) (1,24)	.756 (19,20)	0.764 (19,41)	1.068 (27,13)
.049-.079 (1,24) (2,01)	.764 (19,41)	0.780 (19,81)	1.076 (27,33)
.079-.118 (2,01) (3,00)	.780 (19,81)	n/a	1.092 (27,74)

## TERMINATIONS

**05** QUICK CONNECT

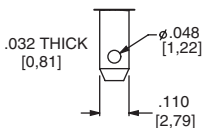

## ACTUATOR MARKINGS

**NONE** NO MARKING

**D** ON-OFF

**H** O I

**P** O -

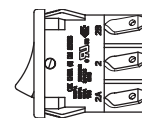
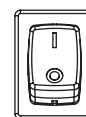

NOTE: Orientation of actuator markings and terminals.

'D' & 'P' marking options: marking color white, standard for all actuator colors except white actuators. Black marking color standard for white actuators. Consult Customer Service Center for other available marking colors.

## CONTACT MATERIAL

OPTION CODE	CONTACT AND TERMINAL MATERIAL	RATINGS		
<b>Q</b>	SILVER 1,2	DM21, DM22:	GP (general purpose)	3 AMPS 125 VAC 50/60 Hz T85 10,000 cycles
				2 AMPS 250 VAC 50/60 Hz T85 10,000 cycles
		DM61, DM62:	R (resistive)	3 AMPS 30 VDC T85 10,000 cycles
			GP (general purpose)	10 AMPS 125 VAC 50/60 Hz T85 10,000 cycles
		5 AMPS 250 VAC 50/60 Hz T85 10,000 cycles		
		R (resistive)	10 AMPS 30 VDC T85 10,000 cycles	

\* Note: See Technical Data section of this catalog for RoHS compliant and compatible definitions and specifications.

<sup>1</sup> MOVABLE CONTACT: DM2X Models: Copper, silver plated.  
DM6X Models: Coin silver, silver plated.

<sup>2</sup> STATIONARY CONTACTS & TERMINALS: Copper or brass, silver plated.

NOTE: Any models supplied with Q contact material are RoHS compliant.

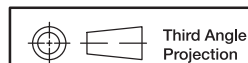

Dimensions are shown: Inches (mm)  
Specifications and dimensions subject to change

# DM Series Miniature 2 Pole Power Rocker Switches

## AVAILABLE HARDWARE

### Insert

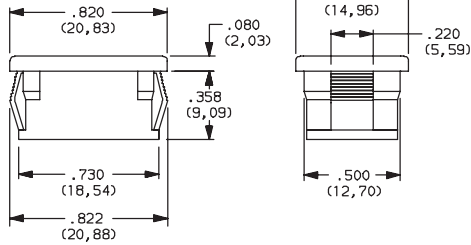

**PART NO.**  
**057190200**

Material: Nylon 6/6  
Finish: Matte

### Recessed Actuator Guard

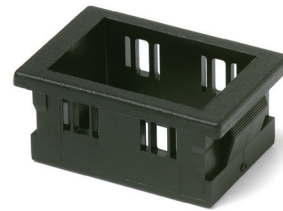

**PART NO.**  
**599D02000**

Material: 6/6 Nylon  
Finish: Matte

### Actuator Guard

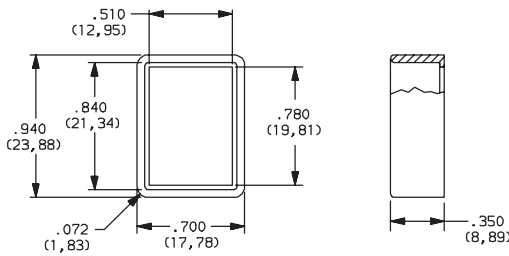

**PART NO.**  
**104C22000**

Material: PBT thermoplastic  
Finish: Matte

**PART NO.**  
**216C00000** IP54 SPLASH PROOF RUBBER BOOT

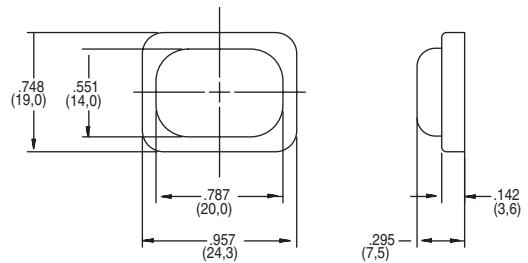

# DM Series Miniature Illuminated Power Rocker Switches

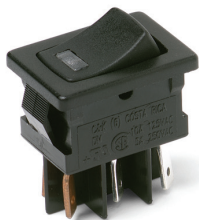

## Features/Benefits

- 3 AMPS to 10 AMPS
- Illuminated LED
- Positive detent
- RoHS compliant

## Typical Applications

- Instrumentation
- Industrial
- Office machines

## Specifications

CONTACT RATING:

DM14 and DM24 Models:

GP (general purpose)

3 AMPS @ 125 V AC; 2 AMPS @ 250 V AC.

R (resistive)

3 AMPS 30 VDC 10,000 cycles

DM54 and DM64 Models:

GP (general purpose)

10 AMPS @ 125 V AC; 5 AMPS @ 250 V AC (UL).

R (resistive)

10 AMPS 30 VDC 10,000 cycles

ELECTRICAL LIFE: 10,000 make-and-break cycles at full load.

INSULATION RESISTANCE:  $10^9 \Omega$  min.

DIELECTRIC STRENGTH: 1,000 Vrms min. @ sea level.

## Materials

HOUSING: 6/6 nylon (UL94V-2), black.

ACTUATOR: 6/6 nylon (UL94V-2), black.

MOVABLE CONTACTS: DM14 and DM24 Models: Copper, silver plated. DM54 and DM64 Models: Coin silver, silver plated.

STATIONARY CONTACTS & TERMINALS: Copper or brass, silver plated.

LED TERMINALS: Brass, unplated.

CONTACT SPRING: Music wire or stainless steel.

OPERATING TEMPERATURE: -20°C to +65°C

**NOTE:** Any models supplied with Q contact material are RoHS compliant.

**NOTE:** Specification and materials listed above are for standard switches. For information on specific and custom switches, consult Customer Service Center.

## Build-A-Switch

To order, simply select desired option from each category and place in the appropriate box. Available options are shown and described on pages G-70 and G-73. For additional options not shown in catalog, consult Customer Service Center.

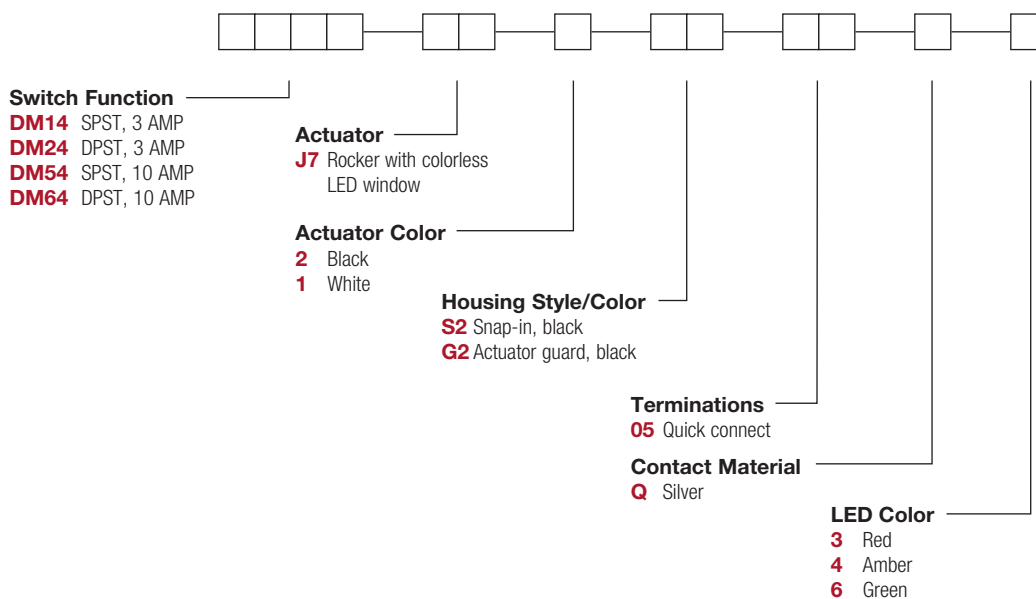

# DM Series Miniature Illuminated Power Rocker Switches

## SWITCH FUNCTION



NO. POLES	MODEL NO.	AMP RATING*	SWITCH FUNCTION		CONNECTED TERMINALS		SCHEMATIC
			POS. 1	POS. 2	POS. 1	POS. 2	
SP	<b>DM14</b>	3	ON	OFF	1-1A	OPEN	
	<b>DM54</b>	10					
DP	<b>DM24</b>	3	ON	OFF	1-1A, 2-2A	OPEN	
	<b>DM64</b>	10					

**DPDT**

Actuator shown in pos. 1 - 'ON' position.  
SPST MODELS (DM14 & DM54) OMIT TERMINALS 2 & 2A.

Part number shown: DM24J72S205Q3

\* RATINGS: see page G-69.



## ACTUATOR



**J7** ROCKER WITH COLORLESS LED WINDOW

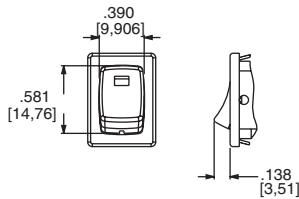

OPTION CODE	ACTUATOR COLOR
<b>2</b>	BLACK
<b>1</b>	WHITE

**NOTE:** Other colors available, consult Customer Service Center.

## HOUSING STYLE/COLOR



**S2** SNAP-IN, BLACK

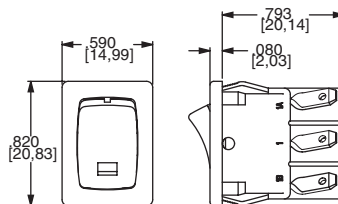

**NOTE:** Housing finish: matte. Other colors available, consult Customer Service Center.

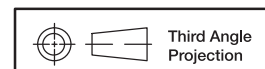

Dimensions are shown: Inches (mm)  
Specifications and dimensions subject to change



15 May 20



# DM Series Miniature Illuminated Power Rocker Switches

## HOUSING STYLE/COLOR

**G2** ACTUATOR GUARD, BLACK

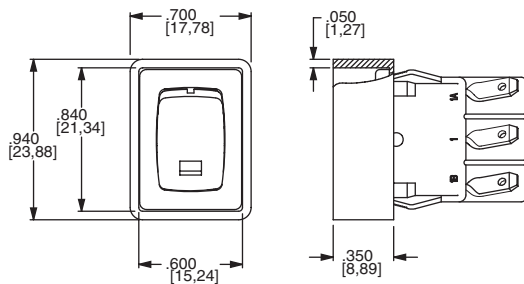

### PANEL MOUNTING

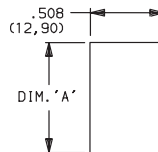

'S2' & 'G2' housing style

**NOTE:** Blank insert available for SP models only, see page H-80.

PANEL THICKNESS	DIM 'A' 'S2' & 'G2' HOUSING STYLES	DIM 'A' with 'G2' option SP MODELS ONLY
.030-.049 (0,76) (1,24)	0.756 (19,20)	0.764 (19,41)
.049-.079 (1,24) (2,01)	0.764 (19,41)	0.780 (19,81)
.079-.118 (2,01) (3,00)	.780 (19,81)	n/a

## TERMINATIONS

**05** QUICK CONNECT

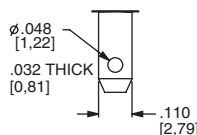

## CONTACT MATERIAL

OPTION CODE	CONTACT AND TERMINAL MATERIAL	RATINGS			
<b>Q</b>	SILVER 1,2	POWER	DM14, DM24:	GP (general purpose)	3 AMPS @ 125 V AC; 2 AMPS @ 250 V AC.
				R (resistive)	3 AMPS 30 VDC 10,000 cycles
			DM54, DM64:	GP (general purpose)	10 AMPS @ 125 V AC; 5 AMPS @ 250 V AC.
				R (resistive)	10 AMPS 30 VDC 10,000 cycles

\* Note: See Technical Data section of this catalog for RoHS compliant and compatible definitions and specifications.

<sup>1</sup> MOVABLE CONTACTS: DM14 and DM24 models: Copper, silver plated.  
DM54 and DM64 models: Coin silver, silver plated.

<sup>2</sup> STATIONARY CONTACTS & TERMINALS: Copper or brass, silver plated.

**NOTE:** Any models supplied with Q contact material are RoHS compliant.



## LED COLOR

OPTION CODE	LED COLOR	FORWARD V <sub>FD</sub>	CURRENT I <sub>LED</sub>	REVERSE V <sub>R</sub>	INTENSITY M <sub>CD</sub>	RECOMMENDED RESISTOR @ VOLTAGE		
						5V	12V	24V
<b>3</b>	Red	2.1	10	4V	1.6 typ.	270	1K	2.2K
<b>4</b>	Amber	2.2	20	4V	2.5 typ.	150	510	1.2K
<b>6</b>	Green	2.1	20	4V	2.0 typ.	150	510	1.2K



Dimensions are shown: Inches (mm)  
Specifications and dimensions subject to change

Rocker



15 May 20



# DM Series Miniature Illuminated Power Rocker Switches

## AVAILABLE HARDWARE

### Blank Insert

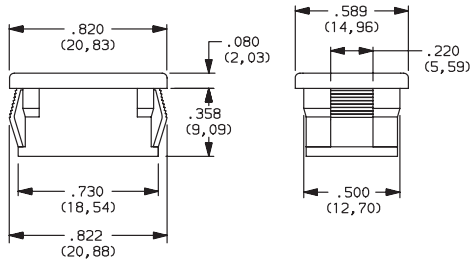

**PART NO.**  
**057190200**

Material: Zinc nylon 6/6  
Finish: Matte

### Recessed Bracket

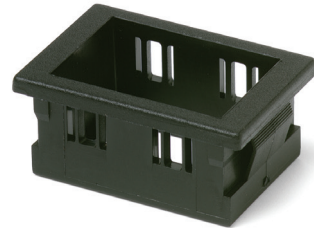

**PART NO.**  
**599D02000**

Material: 6/6 Nylon  
Finish: Matte

### Actuator Guard

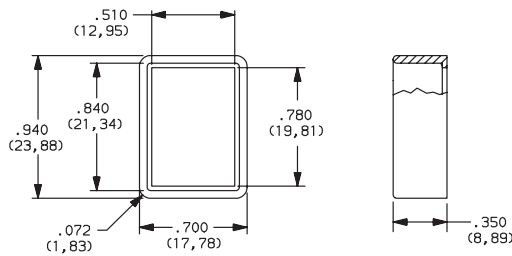

**PART NO.**  
**104C22000**

Material: PBT thermoplastic  
Finish: Matte

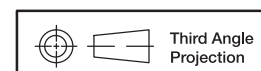

Dimensions are shown: Inches (mm)  
Specifications and dimensions subject to change

# DF Series Power Rocker Switches



## Features/Benefits

- Power switching up to 16 AMPS
- Sub-panel and Front-panel mounting
- PC and quick connect terminals
- Multi-position and multi-pole function
- RoHS compliant

## Typical Applications

- Computers
- Power supplies
- Appliances
- Fitness equipment
- Off-road vehicles



## Specifications

CONTACT RATING: 16 AMPS @ 125, 250 V AC; 1/4 HP @ 125 V AC; 1/2 HP @ 250 V AC; 6 AMPS @ 48 V DC, 2 AMPS @ 60 V DC, 11 AMPS @ 30 V DC

ELECTRICAL LIFE: 10,000 make-and-break cycles at full load.

INSULATION RESISTANCE:  $10^9 \Omega$  min.

DIELECTRIC STRENGTH: 1,000 Vrms min. @ sea level.

OPERATING TEMPERATURE: -20°C to +85°C

## Materials

HOUSING & ACTUATOR: 6/6 nylon (UL 94V-2), black, finish: matte.

CONTACTS: Fine silver, silver plated.

TERMINALS: Copper, silver plated.

CONTACT SPRING: Music wire or stainless steel.

**NOTE:** Specifications and materials listed above are for standard switches. For information on specific and custom switches, consult Customer Service Center.

## Build-A-Switch

To order, simply select desired option from each category and place in the appropriate box. Available options are shown and described on pages G-74 thru G-76. For additional options not shown in catalog, consult Customer Service Center.

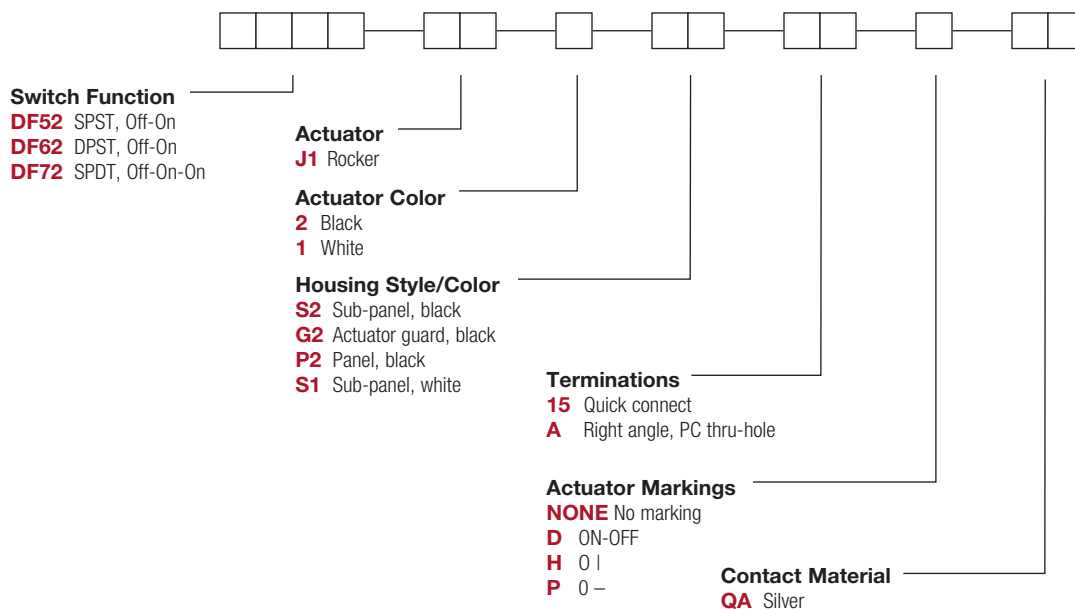

# DF Series Power Rocker Switches

## SWITCH FUNCTION



NO. POLES	MODEL NO.	SWITCH FUNCTION		CONNECTED TERMINALS		SCHEMATIC
		POS. 1	POS. 2	POS. 1	POS. 2	
SP	<b>DF52</b>	OFF	ON	OPEN	1-1A	SPST 
DP	<b>DF62</b>	OFF	ON	OPEN	1-1A, 2-2A	DPST 

Part Number shown DF62J12S215QA

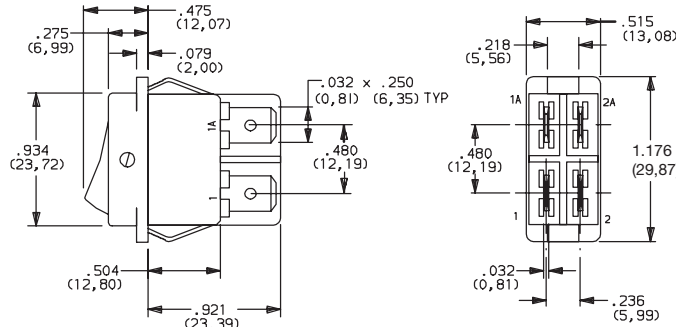

Actuator shown in Pos. 1

NO. POLES	MODEL NO.	POS. 1	POS. 2	POS. 3	POS. 1	POS. 2	POS. 3	SCHEMATIC
SP	<b>DF72</b>	OFF	ON	ON	OPEN	1 / 2-2A	1 / 2-1A 1 / 2-2A	POS. 1: POS. 2: POS. 3:

All models

## ACTUATOR

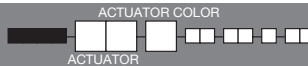

**J1** ROCKER

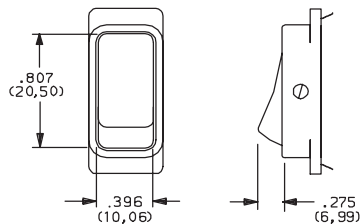

OPTION CODE	ACTUATOR COLOR
<b>2</b>	BLACK
<b>1</b>	WHITE

**NOTE:** Actuator finish: matte. Other colors available, consult Customer Service Center.

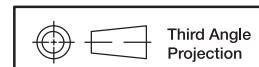

Third Angle Projection

Dimensions are shown: Inches (mm)  
Specifications and dimensions subject to change



# DF Series Power Rocker Switches

## HOUSING STYLE/COLOR



### S SUB-PANEL

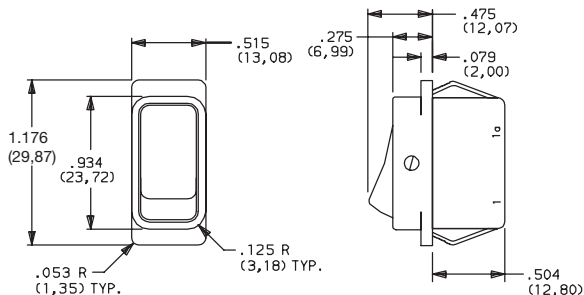

NOTE: DF52 & DF62 models only.

### G2 ACTUATOR GUARD

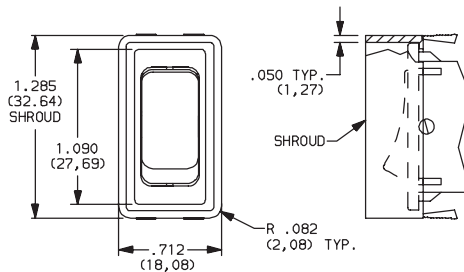

NOTE: Not available with 'A' termination. Available in black only.

### P PANEL

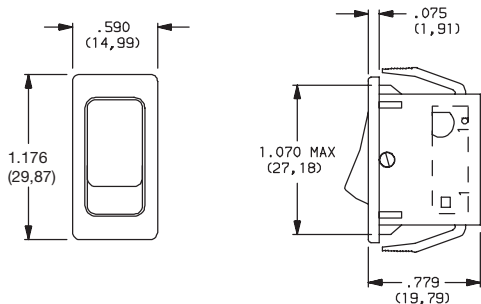

NOTE: Not available with 'A' termination. Available in black only.

OPTION CODE	HOUSING COLOR
<b>2</b>	(STD.) BLACK
<b>1</b>	WHITE

NOTE: Housing finish: matte. Other colors available, consult Customer Service Center.

### PANEL MOUNTING

PANEL THICKNESS	DIM 'A'
.029-.048 (0.74) (1.22)	1.021 (25.93)
.048-.078 (1.22) (1.98)	1.029 (26.14)
.078-.117 (1.98) (2.97)	1.045 (26.54)
.075-.140 (1.91) (3.56)	1.075 (27.31)

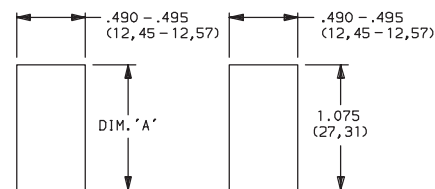

DF52 & DF62 Models with 'S' housing style

DF52, DF62 & DF72 Models with 'P2' & 'G2' housing style

## TERMINATIONS



### 15 QUICK CONNECT

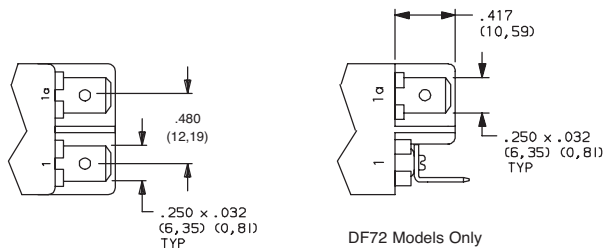

### A RIGHT ANGLE, PC THRU-HOLE

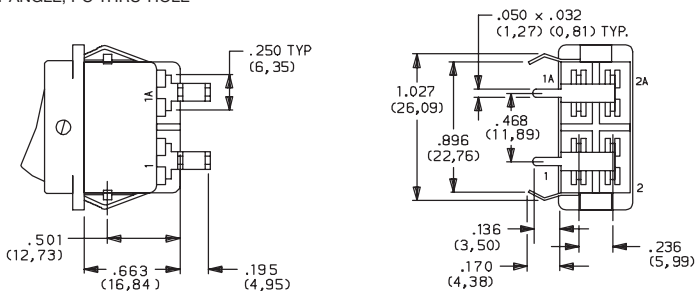

Actuator shown in Pos. 1

NOTE: DF52 and DF62 Models Only

### PC MOUNTING

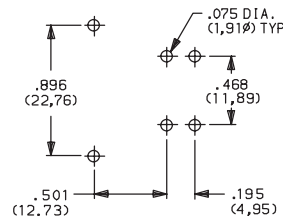

Third Angle Projection

Dimensions are shown: Inches (mm)  
Specifications and dimensions subject to change

Rocker

G

**C&K**

# DF Series Power Rocker Switches

## ACTUATOR MARKINGS

**NONE** NO MARKING

**D** ON-OFF

**H** O |

**P** O -

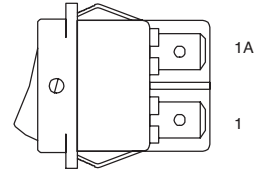

**NOTE:** Orientation of actuator markings and terminals.

'D, H, & P' marking options: marking color white, standard for all actuator colors except white. Marking color black, standard for white actuators. Consult Customer Service Center for other available marking colors.

## CONTACT MATERIAL

OPTION CODE	CONTACT AND TERMINAL MATERIAL	RATINGS	
<b>QA</b>	SILVER <sup>1,2</sup>	POWER	16 AMPS @ 125, 250 V AC; 1/4 HP @ 125 V AC; 1/2 HP @ 250 V AC; 6 AMPS @ 48 V DC (UL), 2 AMPS @ 60 V DC, 11 AMPS @ 30 V DC
			16 AMPS @ 125, 250 V AC; 1/4 HP @ 125 V AC; 1/2 HP @ 250 V AC (UL)

\* Note: See Technical Data section of this catalog for RoHS compliant and compatible definitions and specifications.

<sup>1</sup> CONTACTS: Fine silver, silver plated.

All models 

<sup>2</sup> TERMINALS: Copper, silver plated.

## AVAILABLE HARDWARE

### Actuator Guard

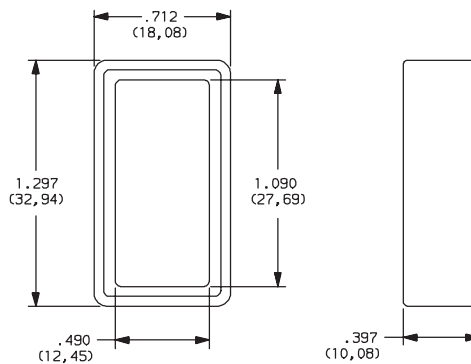

**PART NO.**

**285B02000**

Material: Nylon 6/6

Finish: Matte

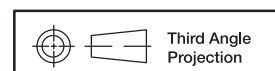

Dimensions are shown: Inches (mm)  
Specifications and dimensions subject to change



# CR Series Round Single Pole Specialty Rocker Switches

## Features/Benefits

- Round actuator and body
- Nice styling
- Multiple illuminated versions available
- IP65 splash proof rubber boot option

## Typical Applications

- Appliances, small and large
- Office equipment
- Computers and peripherals
- Audio/Video equipment
- RoHS compliant



**UL** US UL 61058-1

## Specifications

### CONTACT RATING:

16 AMPS @ 125 VAC, 10 AMPS @ 250 VAC.

16 AMPS @ 125 VAC, 10 AMPS @ 250 VAC.

ELECTRICAL LIFE: 10,000 make and break cycles at full load.

INSULATION RESISTANCE:  $10^8 \Omega$  min.

DIELECTRIC STRENGTH: 1,500 VRMS @ sea level.

OPERATING TEMPERATURE: -20°C to + 85°C

## Materials

HOUSING AND ACTUATOR: 6/6 nylon (UL94V-2), matte finish.

ILLUMINATED ACTUATOR: Polycarbonate, matte finish.

CENTER CONTACTS: Silver plated, copper alloy.

END CONTACTS: Silver plated AgSnO<sub>2</sub>InO<sub>3</sub>.

ALL TERMINALS: Silver plated, copper alloy.

**NOTE:** Specifications and materials listed above are for switches with standard options. For information on specific and custom switches, consult Customer Service Center.

## Build-A-Switch

To order, simply select desired option from each category and place in the appropriate box. Available options are shown and described on pages G-78 through G-80. For additional options not shown in catalog, consult Customer Service Center.

<b>Switch Function</b>	_____						
<b>CR101</b>	SPDT On-None-On						
<b>CR102</b>	SPST On-None-Off						
<b>Actuator</b>	_____						
<b>J1</b>	Rocker						
<b>J2*</b>	Two-tone rocker						
<b>J3</b>	Illuminated rocker						
<b>J4**</b>	Circle, illuminated rocker						
<b>J5</b>	Oval, illuminated rocker						
<b>JN</b>	Paddle, rocker						
<b>JP</b>	Paddle, illuminated rocker						
<b>Actuator Color</b>	_____						
<b>2</b>	Black						
<b>1</b>	White						
<b>3</b>	Red						
<b>R</b>	Red, illuminated						
<b>A</b>	Amber, illuminated						
<b>G</b>	Green, illuminated						
<b>Mounting Style/Color</b>	_____						
<b>S2</b>	Snap-in, black						
<b>S1</b>	Snap-in, white						
<b>Termination</b>	_____						
<b>15</b>	.187" quick connect						
<b>Contact Rating</b>	_____						
<b>QF</b>	Silver						
<b>Lamp Rating</b>	_____						
<b>(NONE)</b>	No lamp						
<b>6</b>	LED						
<b>7</b>	125 VAC neon						
<b>8</b>	250 VAC neon						

\* Refer to table on page G-79 for actuator options.

# CR Series Round Single Pole Specialty Rocker Switches

## SWITCH FUNCTION



NO. POLES	MODEL NO.	SWITCH FUNCTION			CONNECTED TERMINALS			SCHEMATIC
		Pos. 1	Pos. 2	Pos. 3	Pos. 1	Pos. 2	Pos. 3	
	<b>CR101</b>	ON	NONE	ON	2-3		2-1	
	<b>CR102</b>	ON	NONE	OFF		N/A		
SP								For 7 & 8 Illuminated Versions 

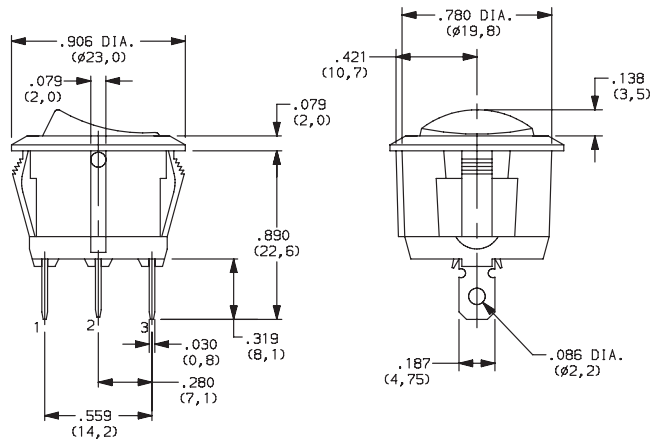

## ACTUATOR



- J1** ROCKER
- J3** ILLUMINATED ROCKER

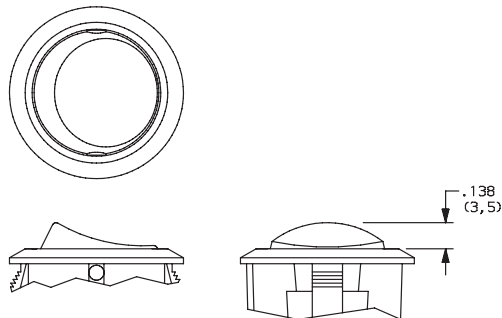

- J2** TWO-TONE ROCKER

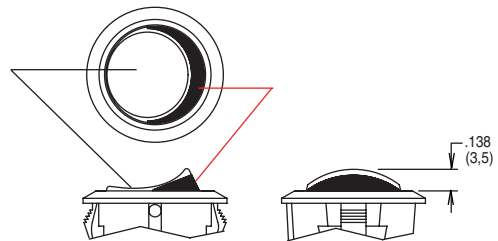

**NOTE:** J3 actuator available with the combination of 7 & 8 lamp ratings and CR102 switch function only.

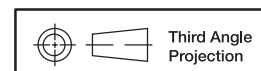

Dimensions are shown: Inches (mm)  
Specifications and dimensions subject to change



# CR Series Round Single Pole Specialty Rocker Switches

## ACTUATOR



**J4** CIRCLE, ILLUMINATED ROCKER

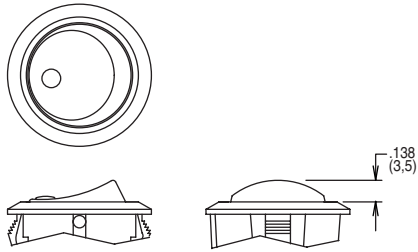

**NOTE:** Available with the combination of CR102 switch function and 7 & 8 lamp ratings only.

**J5** OVAL, ILLUMINATED ROCKER

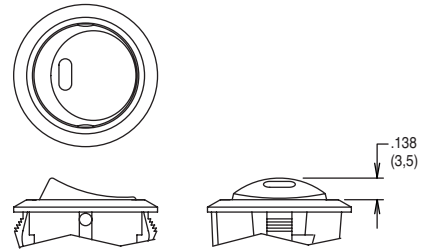

**NOTE:** Available with the combination of CR102 switch function and 6 lamp rating only.

**JN** PADDLE, ROCKER

**JP** PADDLE, ILLUMINATED ROCKER

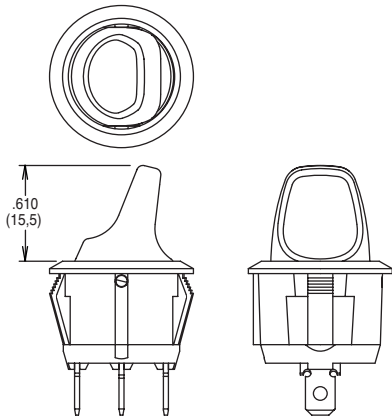

**NOTE:** JP actuator available with the combination of CR102 switch function and 7 & 8 lamp ratings only.

## ACTUATOR COLOR



ACTUATOR	OPTION CODE	ACTUATOR COLOR
<b>J1</b>	<b>2</b>	BLACK
	<b>1</b>	WHITE
	<b>3</b>	RED
<b>J3, J4</b> <b>J5, JP</b>	<b>R</b>	RED, ILLUMINATED
	<b>A</b>	AMBER, ILLUMINATED
	<b>G</b>	GREEN, ILLUMINATED

ACTUATOR	OPTION CODE	ACTUATOR COLOR	
		TOP	BOTTOM
<b>J2</b>	<b>1</b>	WHITE	RED
	<b>2</b>	WHITE	BLACK
	<b>3</b>	RED	WHITE
	<b>4</b>	BLACK	WHITE
	<b>5</b>	BLACK	RED

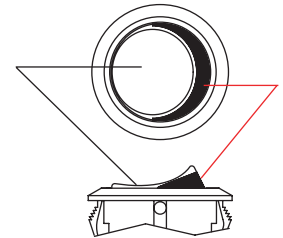

J2 actuator only

## MOUNTING STYLE/COLOR



**S2** SNAP-IN, BLACK

**S1** SNAP-IN, WHITE

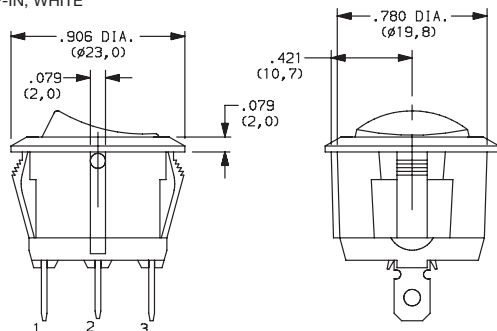

### PANEL MOUNTING

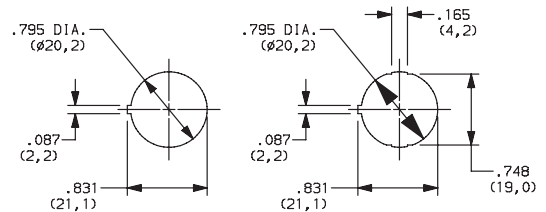

Panel thickness:  
2.0 - 3.0 mm

Panel thickness:  
0.7 - 3.0 mm



Dimensions are shown: Inches (mm)

Specifications and dimensions subject to change

Rocker

G

**C&K**



# CR Series Round Single Pole Specialty Rocker Switches

## TERMINATION



**15** .187" QUICK CONNECT

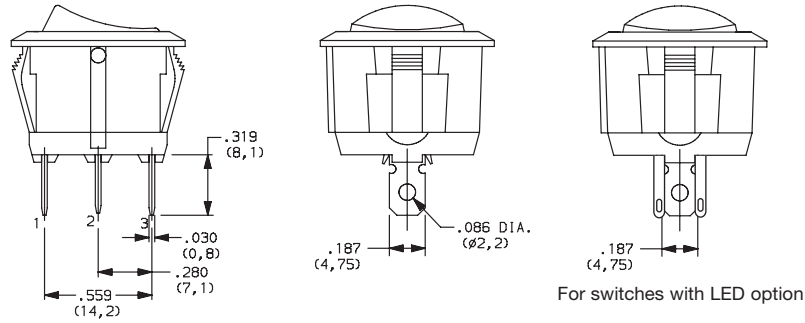

## CONTACT MATERIAL



OPTION CODE	CONTACT AND TERMINAL MATERIAL	RATINGS		C <sub>RU</sub> US
		POWER	16 AMPS @ 125 VAC; 10 AMPS @ 250 VAC	
<b>QF</b>	SILVER			

\* Note: See Technical Data section of this catalog for RoHS compliant and compatible definitions and specifications.

## LAMP RATING



**(NONE)** NO LAMP

**6** LED RATING @ 10 mA  $V_f=1.85V$

**7** 125 VAC 33kΩ NEON

**8** 250 VAC 150kΩ NEON

## ACCESSORIES

**377C00000** IP65 SPLASH PROOF RUBBER BOOT

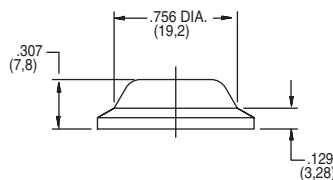
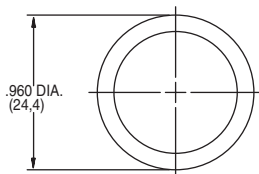

Dimensions are shown: Inches (mm)  
Specifications and dimensions subject to change



## Features/Benefits

- Various designs up to 16 amps
- Heavy duty and extended life cycles
- SPST, SPDT and DPST options
- Different symbols available

## Typical Applications

- Household appliances
- Industrial equipment
- Audio & visual equipment
- Telecommunication
- Office equipment



## Specifications

CONTACT RATING: 6.5 Amps @ 125 VAC  
 ELECTRICAL LIFE: 6,000 cycles at full load.  
 INITIAL CONTACT RESISTANCE: 100m  $\Omega$  min.  
 INSULATION RESISTANCE: 100M  $\Omega$  min.  
 DIELECTRIC STRENGTH: 1,500 VAC (50-60 Hz)  
 OPERATING FORCE: ON\_OFF: 250  $\pm$  100 gf  
                             OFF\_ON: 700  $\pm$  250 gf  
 PACKAGING:       300 pieces per bag (5 trays)  
                             2,400 pieces per box

## Materials

HOUSING: PA (UL 94V-2).  
 KNOB: PA (UL 94V-2).  
 CONTACTS: Silver plated.

**NOTE:** Specifications and materials listed above are for switches with standard options. For information on specific and custom switches, consult Customer Service Center.

## Environmental

OPERATING TEMPERATURE: 0°C to 65°C

PART NUMBER	HOUSING COLOR
SW-13A65N-A01	White
SW-13A65N-A01 BK	Black
SW-11A06N-A02	Black
SW-11A06N-A03 AP	Black
SW-11A06N-B02	Black
SW-11A06N-B02 AP	Black
SW-11A06N-CR02	Black
SW-12A06N-B02	Black
SW-12A06N-F01	Black
SW-12B03N	Black
SW-13A65N-A01 AK	Almond
SW-13A65N-A01 BI	Biscuit

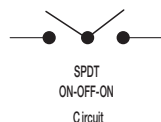
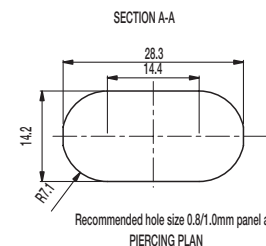
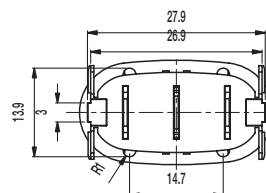
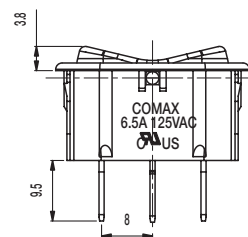
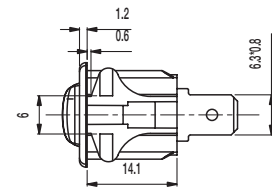
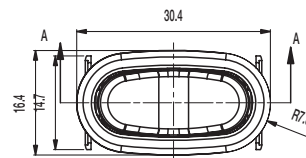

# CG Series Single Pole Power Rocker Switches

## Features/Benefits

- Bevelled frame
- Illuminated versions available
- Easy panel mount installation

## Typical Applications

- Computers and peripherals
- Small appliances
- Instrument panels
- Industrial controls
- RoHS compliant



**UL** **UL 61058-1**

## Specifications

CONTACT RATING:  
 16 AMPS @ 125 VAC, 10 AMPS @ 250 VAC.  
 10 AMPS @ 250 VAC, 6 AMPS @ 250 VAC.  
 ELECTRICAL LIFE: 10,000 make and break cycles at full load.  
 INSULATION RESISTANCE:  $10^8 \Omega$  min.  
 DIELECTRIC STRENGTH: 1,500 VRMS @ sea level.  
 OPERATING TEMPERATURE: -20°C to +85°C

## Materials

HOUSING AND ACTUATOR: 6/6 nylon (UL94V-2), black, matte finish.  
 ILLUMINATED ACTUATOR: Polycarbonate, matte finish.  
 CENTER CONTACTS: Silver plated, copper alloy.  
 END CONTACTS: Silver plated.  
 ALL TERMINALS: Silver plated, copper alloy.

**NOTE:** Specifications and materials listed above are for switches with standard options. For information on specific and custom switches, consult Customer Service Center.

## Build-A-Switch

To order, simply select desired option from each category and place in the appropriate box. Available options are shown and described on pages G-87 through G-89. For additional options not shown in catalog, consult Customer Service Center.

<b>Switch Function</b>	_____								
<b>CG101</b> SPDT On-None-On									
<b>CG102</b> SPST On-None-Off									
<b>CG103</b> SPDT On-Off-On									
<b>CG105</b> SPDT Mom-Off-Mom									
<b>CG12 *</b> SPST On-None-Off									
<b>Actuator</b>	_____								
<b>J1</b> Rocker									
<b>J2 **</b> Two-tone rocker									
<b>J3</b> Illuminated rocker									
<b>Actuator Color</b>	_____								
<b>2</b> Black									
<b>1</b> White									
<b>3</b> Red									
<b>R</b> Red, illuminated									
<b>A</b> Amber, illuminated									
<b>G</b> Green, illuminated									
<b>Mounting Style/Color</b>	_____								
<b>S2</b> Snap-in, black									
<b>S1</b> Snap-in, white									
<b>Termination</b>	_____								
<b>05</b> .250" quick connect									
<b>Actuator Marking</b>	_____								
<b>(NONE)</b> No marking									
<b>D</b> ON-OFF									
<b>H</b> "O I" - international ON-OFF									
<b>P</b> "O -" international ON-OFF									
<b>Contact Rating</b>	_____								
<b>QF</b> Silver									
<b>Lamp Rating</b>	_____								
<b>(NONE)</b> No lamp									
<b>7</b> 125 VAC neon									
<b>8</b> 250 VAC neon									

\* CG12 — for switches with both marking and illumination

\*\* J2 — refer to table on next page for actuator options

# CG Series Single Pole Power Rocker Switches

## SWITCH FUNCTION



NO. POLES	MODEL NO.	SWITCH FUNCTION			CONNECTED TERMINALS			SCHEMATIC
		Pos. 1	Pos. 2	Pos. 3	Pos. 1	Pos. 2	Pos. 3	
		C&K marking on opposite side			C&K marking on opposite side			
SP	<b>CG101</b>	ON	NONE	ON	1-2		2-3	
	<b>CG102</b>	ON	NONE	OFF	1-2	N/A	OPEN	
	<b>CG103</b>	ON	OFF	ON	1-2	OPEN	2-3	
	<b>CG105</b>	MOM	OFF	MOM	1-2	OPEN	2-3	
	<b>CG12 *</b>	ON	NONE	OFF	1-2	N/A	OPEN	

\* CG12 - for switches with both marking and illumination

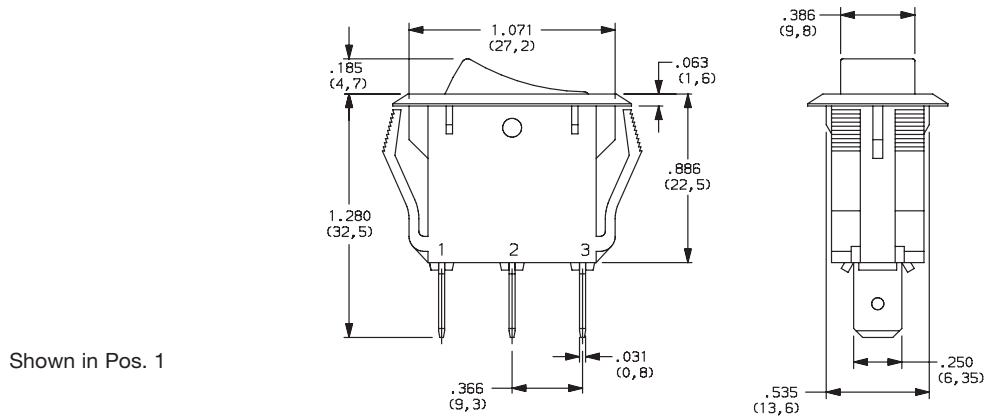

## ACTUATOR



- J1** ROCKER
- J3** ILLUMINATED ROCKER

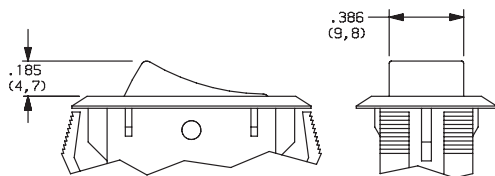

NOTE: J3 actuator available with CG102 switch function only.

- J2** TWO-TONE ROCKER

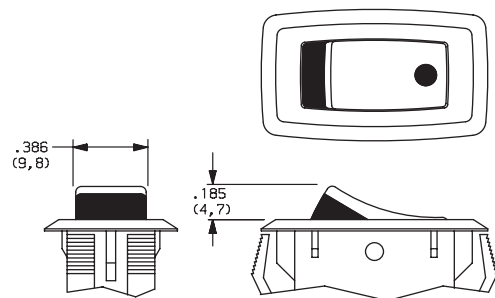

NOTE: Available with CG102 switch function only.

Rocker



Third Angle Projection

Dimensions are shown: Inches (mm)  
Specifications and dimensions subject to change



# CG Series Single Pole Power Rocker Switches

## ACTUATOR COLOR

ACTUATOR	OPTION CODE	ACTUATOR COLOR
<b>J1</b>	<b>2</b>	BLACK
	<b>1</b>	WHITE
	<b>3</b>	RED
<b>J3</b>	<b>R</b>	RED, ILLUMINATED
	<b>A</b>	AMBER, ILLUMINATED
	<b>G</b>	GREEN, ILLUMINATED

OPTION CODE	ACTUATOR COLOR	
	TOP	BOTTOM
<b>1</b>	WHITE	RED
<b>2</b>	WHITE	BLACK
<b>3</b>	RED	WHITE
<b>4</b>	BLACK	WHITE
<b>5</b>	BLACK	RED

J2 actuator only

## MOUNTING STYLE/COLOR

**S2** SNAP-IN, BLACK

**S1** SNAP-IN, WHITE

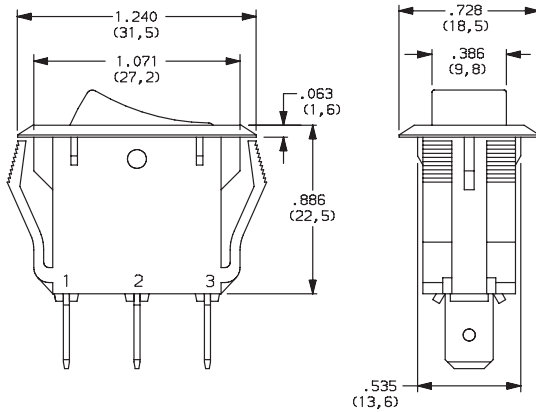

Shown in Pos. 1

### PANEL MOUNTING

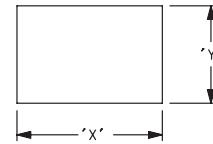

PANEL THICKNESS	"X"	"Y"
0.030-0.049 (0,75-1,25)	1.087-.004 (27,6-0,1)	0.543+.004 (13,8+0,1)
0.049-0.079 (1,25-2,0)	1.094-.004 (27,8-0,1)	0.543+.004 (13,8+0,1)
0.079-0.118 (2,0-3,0)	1.102-.004 (28,0-0,1)	0.543+.004 (13,8+0,1)

## TERMINATION

**05** .250" QUICK CONNECT

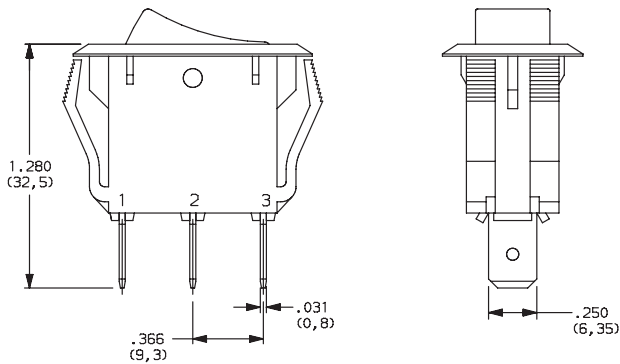

Shown in Pos. 1



# CG Series Single Pole Power Rocker Switches

## ACTUATOR MARKING



**NONE** NO MARKING



**D** ON-OFF



**H** 0 I

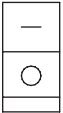

**P** 0 -

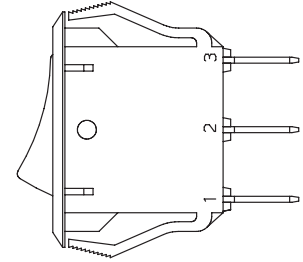
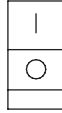

**NOTE:** Orientation of actuator marking and terminals.

Shown in Pos. 1

## CONTACT MATERIAL



OPTION CODE	CONTACT AND TERMINAL MATERIAL	RATINGS	
<b>QF</b>	SILVER	POWER	16 AMPS @ 125 VAC; 10 AMPS @ 250 VAC 10 AMPS @ 250 VAC

\* Note: See Technical Data section of this catalog for RoHS compliant and compatible definitions and specifications.



## LAMP RATING



**(NONE)** NO LAMP

**7** 125 VAC 33kΩ NEON

**8** 250 VAC 150kΩ NEON

**NOTE:** Lamp rating for J3 actuator option.

Rocker



G

**C&K**



Dimensions are shown: Inches (mm)  
Specifications and dimensions subject to change

# CL Series Single Pole Power Rocker Switches

## Features/Benefits

- Illuminated versions available
- Positive detent
- Snap-in mounting

## Typical Applications

- Floor care products
- Power outlet strips
- HVAC units
- RoHS compliant

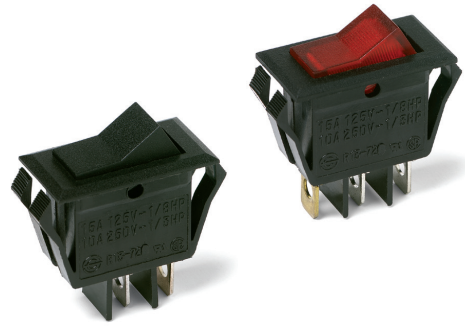

## Specifications

### CONTACT RATING:

- 16 AMPS @ 125 VAC, 1/3 HP;
- 10 AMPS @ 250 VAC, 1/2 HP.

ELECTRICAL LIFE: 10,000 make and break cycles at full load.

INSULATION RESISTANCE:  $10^8 \Omega$  min.

DIELECTRIC STRENGTH: 1,500 VRMS @ sea level.

OPERATING TEMPERATURE: -20°C to +80°C

## Materials

HOUSING AND ACTUATOR: 6/6 nylon (UL94V-2), black, matte finish.

ILLUMINATED ACTUATOR: Polycarbonate, matte finish.

CENTER CONTACTS: Silver plated, copper alloy.

END CONTACTS: Silver plated.

ALL TERMINALS: Silver plated, copper alloy.

**NOTE:** Specifications and materials listed above are for switches with standard options. For information on specific and custom switches, consult Customer Service Center.

## Build-A-Switch

To order, simply select desired option from each category and place in the appropriate box. Available options are shown and described on pages G-91 through G-93. For additional options not shown in catalog, consult Customer Service Center.

<input type="checkbox"/> <input type="checkbox"/> <input type="checkbox"/> <input type="checkbox"/> <input type="checkbox"/> <input type="checkbox"/> <input type="checkbox"/> <input type="checkbox"/> <input type="checkbox"/> <input type="checkbox"/> <input type="checkbox"/> <input type="checkbox"/> <input type="checkbox"/> <input type="checkbox"/> <input type="checkbox"/> <input type="checkbox"/> <input type="checkbox"/> <input type="checkbox"/> <input type="checkbox"/> <input type="checkbox"/>	
<b>Switch Function</b>	
<b>CL101</b> SPDT On-None-On <b>CL102</b> SPST On-None-Off <b>CL12*</b> SPST On-None-Off	
<b>Actuator</b>	
<b>J7</b> Rocker <b>J9</b> Illuminated rocker	
<b>Actuator Color</b>	
<b>2</b> Black <b>1</b> White <b>3</b> Red <b>R</b> Red, illuminated <b>A</b> Amber, illuminated <b>G</b> Green, illuminated	
<b>Mounting Style/Color</b>	
<b>S2</b> Snap-in, black <b>S1</b> Snap-in, white	
<b>Termination</b>	
<b>05</b> .250" quick connect	
<b>Actuator Marking</b>	
<b>(NONE)</b> No marking <b>D</b> ON-OFF <b>H</b> "O I" - international ON-OFF <b>P</b> "O -" international ON-OFF	
<b>Contact Rating</b>	
<b>QA</b> Silver	
<b>Lamp Rating</b>	
<b>(NONE)</b> No lamp <b>7</b> 125 VAC neon <b>8</b> 250 VAC neon	

\* CL12 - for switches with both marking and illumination



Dimensions are shown: Inches (mm)  
Specifications and dimensions subject to change



# CL Series Single Pole Power Rocker Switches

## SWITCH FUNCTION



NO. POLES	MODEL NO.	SWITCH FUNCTION			CONNECTED TERMINALS			SCHEMATIC
		Pos. 1	Pos. 2	Pos. 3	Pos. 1	Pos. 2	Pos. 3	
		C&K marking on opposite side			C&K marking on opposite side			
SP	<b>CL101</b>	ON	NONE	ON	2-1	N/A	2-3	
	<b>CL102</b>	ON	NONE	OFF	2-1		OPEN	 For Illuminated Version
	<b>CL12 *</b>	ON	NONE	OFF				

\* CL12 - for switches with both marking and illumination

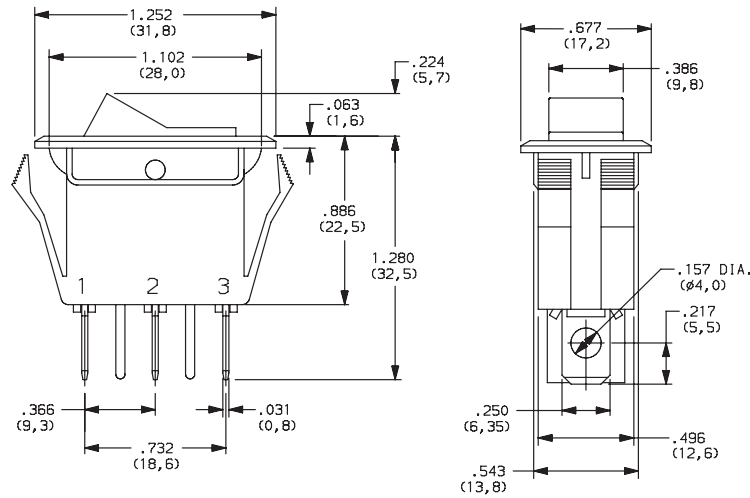

Shown in Pos. 1

## ACTUATOR

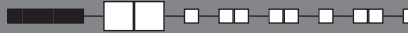

**J7** ROCKER

**J9** ILLUMINATED ROCKER

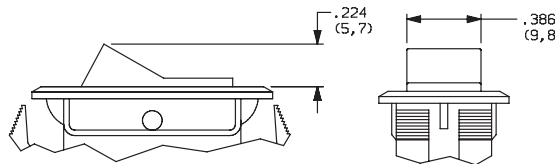

NOTE: J9 actuator available with CL102 & CL12 switch function only.

## ACTUATOR COLOR



OPTION CODE	ACTUATOR COLOR
<b>2</b>	BLACK
<b>1</b>	WHITE
<b>3</b>	RED
<b>R</b>	RED, ILLUMINATED
<b>A</b>	AMBER, ILLUMINATED
<b>G</b>	GREEN, ILLUMINATED

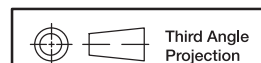

Third Angle Projection

Dimensions are shown: Inches (mm)  
Specifications and dimensions subject to change

Rocker



G

**C&K**



# CL Series Single Pole Power Rocker Switches

## MOUNTING STYLE/COLOR



**S2** SNAP-IN, BLACK

**S1** SNAP-IN, WHITE

### PANEL MOUNTING

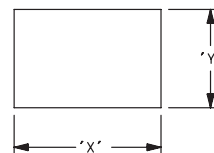

PANEL THICKNESS	"X"	"Y"
0.030-0.049 (0,75-1,25)	1.126-.004 (28,6-0,1)	0.551+.004 (14,0+0,1)
0.049-0.079 (1,25-2,0)	1.134-.004 (28,8-0,1)	0.551+.004 (14,0+0,1)
0.079-0.118 (2,0-3,0)	1.150-.004 (29,2-0,1)	0.551+.004 (14,0+0,1)

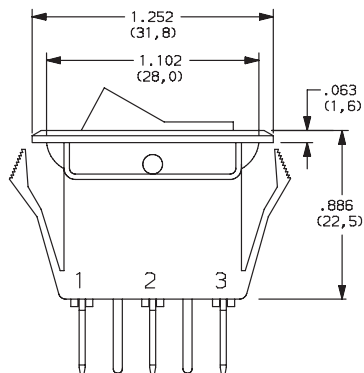

Shown in Pos. 1

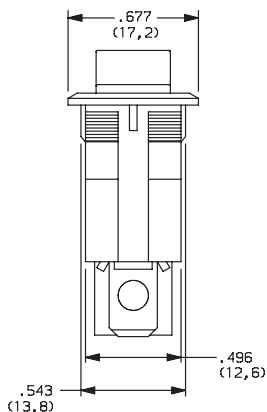

## TERMINATION



**05** .250" QUICK CONNECT

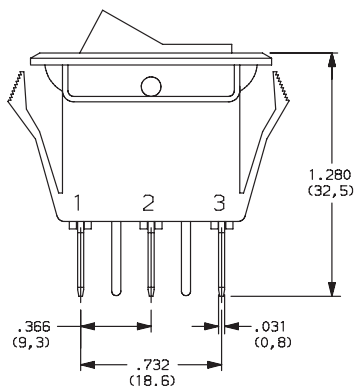

Shown in Pos. 1

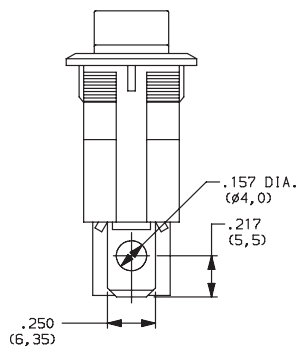

## ACTUATOR MARKING



**NONE** NO MARKING

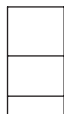

**D** ON-OFF



**H** 0 I

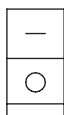

**P** 0 -

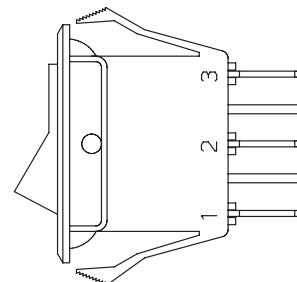
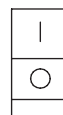

**NOTE:** Orientation of actuator marking and terminals.

Shown in Pos. 1

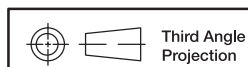

Dimensions are shown: Inches (mm)  
Specifications and dimensions subject to change



# CL Series Single Pole Power Rocker Switches

## CONTACT MATERIAL



OPTION CODE	CONTACT AND TERMINAL MATERIAL	RATINGS	
		QA	SILVER

\* Note: See Technical Data section of this catalog for RoHS compliant and compatible definitions and specifications.



## LAMP RATING



**(NONE)** NO LAMP

**7** 125 VAC 33kΩ NEON

**8** 250 VAC 150kΩ NEON

**NOTE:** Lamp rating for J9 actuator option.

Rocker



G



Dimensions are shown: Inches (mm)  
Specifications and dimensions subject to change

# CM Series Single Pole Power Rocker Switches

## Features/Benefits

- Illuminated versions available
- Easy to install snap-in design
- Multiple actuator and termination styles to choose from

## Typical Applications

- Computers and peripherals
- Power supplies
- Industrial equipment
- Small appliances
- RoHS compliant



## Specifications

### CONTACT RATING:

- 16 AMPS @ 125 VAC, 1/8 HP;
- 10 AMPS @ 250 VAC, 1/3 HP.

ELECTRICAL LIFE: 10,000 make and break cycles at full load.

INSULATION RESISTANCE:  $10^8 \Omega$  min.

DIELECTRIC STRENGTH: 1,500 VRMS @ sea level.

OPERATING TEMPERATURE: -20°C to +80°C

## Materials

HOUSING AND ACTUATOR: 6/6 nylon (UL94V-2), black, gloss or matte finish.

ILLUMINATED ACTUATOR: Polycarbonate, gloss or matte finish.

CENTER CONTACTS: Silver plated, copper alloy.

END CONTACTS: Silver plated.

ALL TERMINALS: Silver plated, copper alloy.

**NOTE:** Specifications and materials listed above are for switches with standard options. For information on specific and custom switches, consult Customer Service Center.

## Build-A-Switch

To order, simply select desired option from each category and place in the appropriate box. Available options are shown and described on pages G-95 through G-97. For additional options not shown in catalog, consult Customer Service Center.

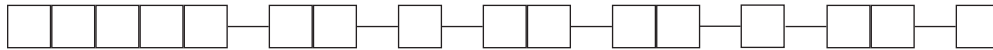

### Switch Function

- CM101** SPDT On-None-On
- CM102** SPST On-None-Off
- CM103** SPDT On-Off-On
- CM107** SPDT On-Off-Mom.
- CM12** \* SPST On-None-Off

### Actuator

- J1** Rocker
- J3** Illuminated rocker

### Actuator Color

- 2** Black
- 1** White
- 3** Red
- R** Red, illuminated
- A** Amber, illuminated
- G** Green, illuminated

### Mounting Style/Color

- S2** Snap-in, black
- S4** Snap-in, black
- S1** Snap-in, white
- S3** Snap-in, white

### Termination

- 05** .250" quick connect
- 07** Solder lug

### Actuator Marking

- (NONE)** No marking
- D** ON-OFF
- H** "O I" - international ON-OFF
- P** "O -" international ON-OFF

### Contact Rating

- QA** Silver

### Lamp Rating

- (NONE)** No lamp
- 7** 125 VAC neon
- 8** 250 VAC neon

\* CM12 - for switches with both marking and illumination

Rocker



# CM Series Single Pole Power Rocker Switches

## SWITCH FUNCTION



NO. POLES	MODEL NO.	SWITCH FUNCTION			CONNECTED TERMINALS			SCHEMATIC	
		Pos. 1	Pos. 2	Pos. 3	Pos. 1	Pos. 2	Pos. 3		
SP	<b>CM101</b>	ON	NONE	ON	2-1	N/A	2-3		
	<b>CM102</b>	ON	NONE	OFF			OPEN		
	<b>CM103</b>	ON	OFF	ON			OPEN	2-3	
	<b>CM107</b>	ON	OFF	MOM.				2-3	
	<b>CM12 *</b>	ON	NONE	OFF				N/A	OPEN

\* CM12 - for switches with both marking and illumination

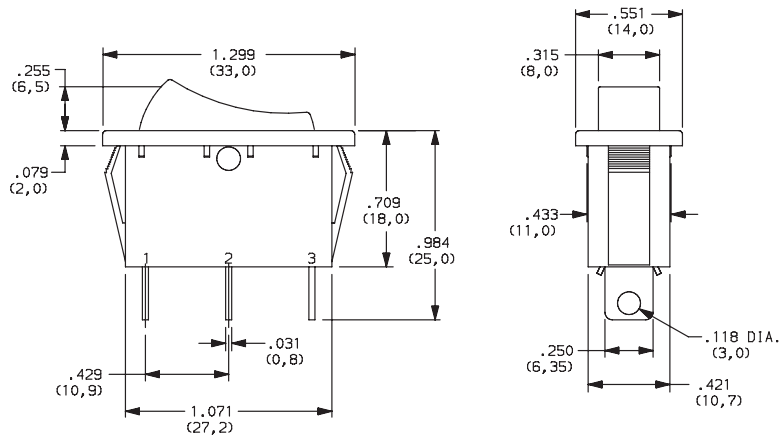

Shown in Pos. 1

## ACTUATOR

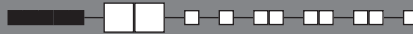

**J1** ROCKER

**J3** ILLUMINATED ROCKER

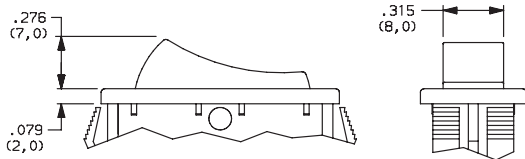

NOTE: J3 actuator available with CM102 & CM12 switch function only.



Third Angle Projection

Dimensions are shown: Inches (mm)  
Specifications and dimensions subject to change

# CM Series Single Pole Power Rocker Switches

## ACTUATOR COLOR



OPTION CODE	ACTUATOR COLOR
<b>2</b>	BLACK
<b>1</b>	WHITE
<b>3</b>	RED
<b>R</b>	RED, ILLUMINATED
<b>A</b>	AMBER, ILLUMINATED
<b>G</b>	GREEN, ILLUMINATED

## MOUNTING STYLE/COLOR



**S2** SNAP-IN, BLACK

**S4** SNAP-IN, BLACK (SHORT FRAME)

**S1** SNAP-IN, WHITE

**S3** SNAP-IN, WHITE

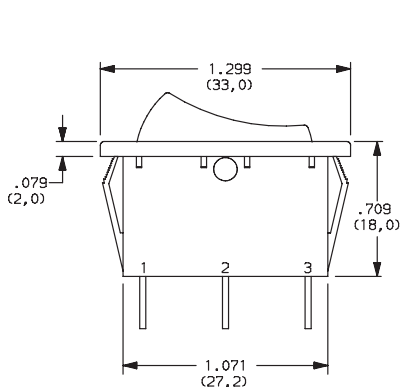

Shown in Pos. 1

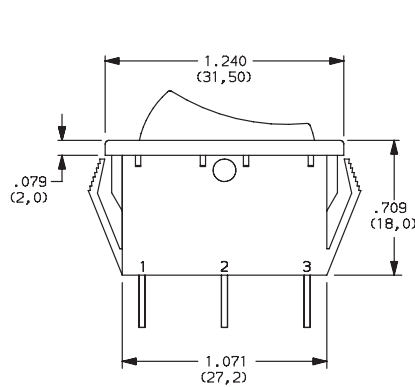
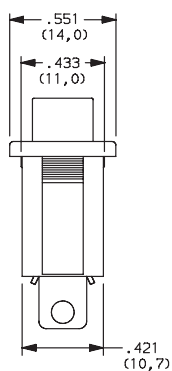

Shown in Pos. 1

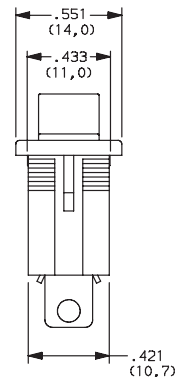

### PANEL MOUNTING

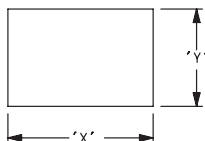

PANEL THICKNESS	"X"	"Y"
0.030-0.049 (0,75-1,25)	1.189-.004 (30,2-0,1)	0.441+.004 (11,2+0,1)
0.049-0.079 (1,25-2,0)	1.197-.004 (30,4-0,1)	0.441+.004 (11,2+0,1)
0.079-0.118 (2,0-3,0)	1.212-.004 (30,8-0,1)	0.441+.004 (11,2+0,1)

## TERMINATION



**05** .250 QUICK CONNECT

**07** SOLDER LUG

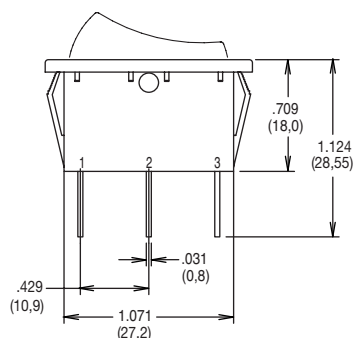

Shown in Pos. 1

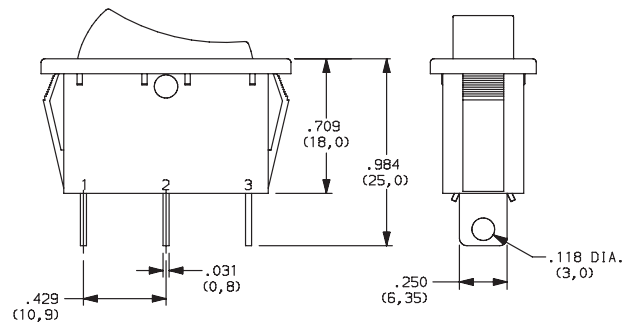
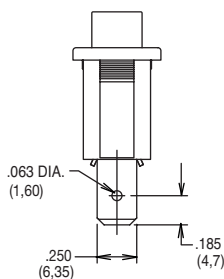

**NOTE:** Available with CM101 & CM102 switch functions only.

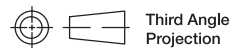

Third Angle Projection  
Dimensions are shown: Inches (mm)  
Specifications and dimensions subject to change



16 May 18



# CM Series Single Pole Power Rocker Switches

## ACTUATOR MARKING



**NONE** NO MARKING

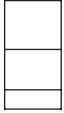

**D** ON-OFF



**H** 0 I

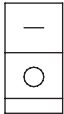

**P** 0 -

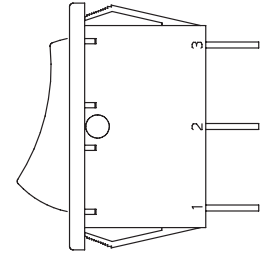

**NOTE:** Orientation of actuator marking and terminals.

Shown in Pos. 1

## CONTACT MATERIAL



OPTION CODE	CONTACT AND TERMINAL MATERIAL	RATINGS	
		<b>QA</b>	SILVER

\* Note: See Technical Data section of this catalog for RoHS compliant and compatible definitions and specifications.



## LAMP RATING



**(NONE)** NO LAMP

**7** 125 VAC 33kΩ NEON

**8** 250 VAC 150kΩ NEON

**NOTE:** Lamp rating for J3 & J8 actuator option.

Rocker



G

**C&K**

16 May 18



Dimensions are shown: Inches (mm)  
Specifications and dimensions subject to change

# CN Series Double Pole Power Rocker Switches

## Features/Benefits

- Illuminated versions available
- Multiple actuator and termination styles
- Robust design
- Custom version upon request
- RoHS compliant



## Typical Applications

- Appliances
- Office equipment
- Computers and peripherals
- Off-road vehicles
- Industrial machines
- HVAC units
- Transportation

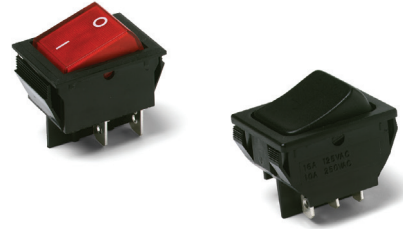

## Specifications

### CONTACT RATING:

See table for Q and QA ratings on the last page of this series.

ELECTRICAL LIFE: 10,000 make and break cycles at full load.

INSULATION RESISTANCE: 10<sup>8</sup> Ω min.

DIELECTRIC STRENGTH: 1,500 VRMS @ sea level.

OPERATING TEMPERATURE: -20°C to +85°C

HOUSING AND ACTUATOR: 6/6 nylon (UL94V-2), black, matte finish.

ILLUMINATED ACTUATOR: Polycarbonate, matte finish.

CENTER CONTACTS: Silver plated, copper alloy.

END CONTACTS: Silver plated Ag<sub>2</sub>SuO<sub>2</sub>InO<sub>3</sub>.

ALL TERMINALS: Silver plated, copper alloy.

**Note:** Specifications and materials listed above are for switches with standard options. For information on specific and custom switches, consult Customer Service Center.

## Materials

## Build-A-Switch

To order, simply select desired option from each category and place in the appropriate box. Available options are shown and described on pages G-99 through G-101. For additional options not shown in catalog, consult Customer Service Center.

<div style="border: 1px solid black; width: 100px; height: 15px; display: inline-block;"></div>		<div style="border: 1px solid black; width: 30px; height: 15px; display: inline-block;"></div>		<div style="border: 1px solid black; width: 20px; height: 15px; display: inline-block;"></div>		<div style="border: 1px solid black; width: 30px; height: 15px; display: inline-block;"></div>		<div style="border: 1px solid black; width: 30px; height: 15px; display: inline-block;"></div>		<div style="border: 1px solid black; width: 30px; height: 15px; display: inline-block;"></div>		<div style="border: 1px solid black; width: 30px; height: 15px; display: inline-block;"></div>		<div style="border: 1px solid black; width: 30px; height: 15px; display: inline-block;"></div>	
<b>Switch Function</b>		<b>Actuator Color</b>		<b>Mounting Style/Color</b>		<b>Termination</b>		<b>Actuator Marking</b>		<b>Contact Rating</b>		<b>Lamp Rating</b>			
<b>CN201</b> DPDT On-None-On <b>CN202</b> DPST On-None-Off <b>CN22</b> * DPST On-None-Off		<b>2</b> Black <b>1</b> White <b>3</b> Red <b>R</b> Red, illuminated <b>A</b> Amber, illuminated <b>G</b> Green, illuminated		<b>S2</b> Snap-in, black <b>S4</b> Snap-in, black <b>S1</b> Snap-in, white <b>S3</b> Snap-in, white		<b>15</b> .187" quick connect <b>05</b> .250" quick connect		<b>(NONE)</b> No marking <b>D</b> ON-OFF <b>H</b> "O I" - international ON-OFF <b>P</b> "O -" international ON-OFF		<b>Q</b> Silver <b>QA</b> Silver (with HP rating)		<b>(NONE)</b> No lamp <b>7</b> 125 VAC neon <b>8</b> 250 VAC neon			

\* CN22 - for switches with both marking and illumination



# CN Series Double Pole Power Rocker Switches

## SWITCH FUNCTION



NO. POLES	MODEL NO.	SWITCH FUNCTION			CONNECTED TERMINALS			SCHEMATIC	
		Pos. 1	Pos. 2	Pos. 3	Pos. 1	Pos. 2	Pos. 3		
		C&K marking on opposite side			C&K marking on opposite side				
DP	<b>CN201</b>	ON	NONE	ON	2-1 4-5	N/A	2-3 6-5		
	<b>CN202</b>	ON	NONE	OFF				OPEN	
	<b>CN22 *</b>	ON	NONE	OFF					

\* CN22 - for switches with both marking and illumination

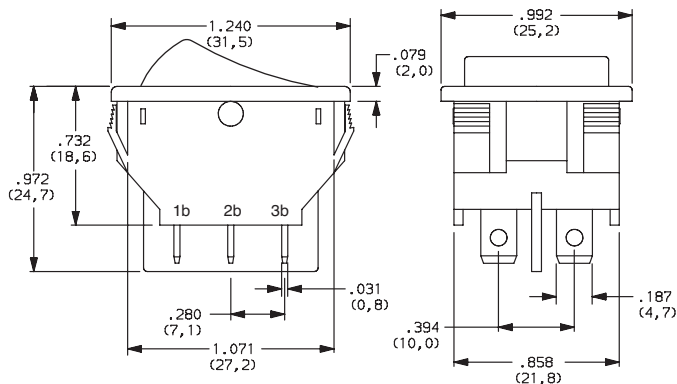

Shown in Pos. 1

## ACTUATOR



- J1** ROCKER
- J3** ILLUMINATED ROCKER

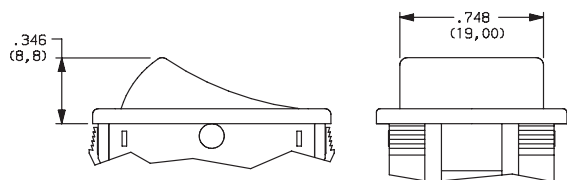

**NOTE:** J1 & J3 actuators available with Q contact rating only.  
J3 actuator available with CN202 & CN22 switch function only.

- J6** ROCKER
- J8** ILLUMINATED ROCKER

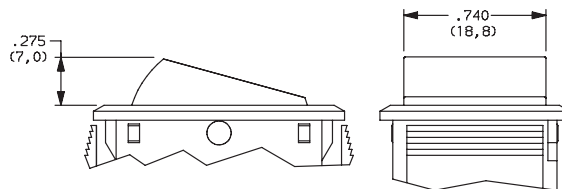

**NOTE:** J6 & J8 actuators available with QA contact rating only.  
J6 actuator available with CN201 & CN202 switch functions,  
J8 actuator available with CN202 & CN22 switch function only.

Rocker

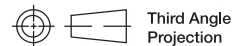

Third Angle  
Projection

Dimensions are shown: Inches (mm)  
Specifications and dimensions subject to change





# CN Series Double Pole Power Rocker Switches

## ACTUATOR COLOR

OPTION CODE	ACTUATOR COLOR
<b>2</b>	BLACK
<b>1</b>	WHITE
<b>3</b>	RED
<b>R</b>	RED, ILLUMINATED
<b>A</b>	AMBER, ILLUMINATED
<b>G</b>	GREEN, ILLUMINATED

## MOUNTING STYLE/COLOR

**S2** SNAP-IN, BLACK

**S1** SNAP-IN, WHITE

**S4** SNAP-IN, BLACK

**S3** SNAP-IN, WHITE

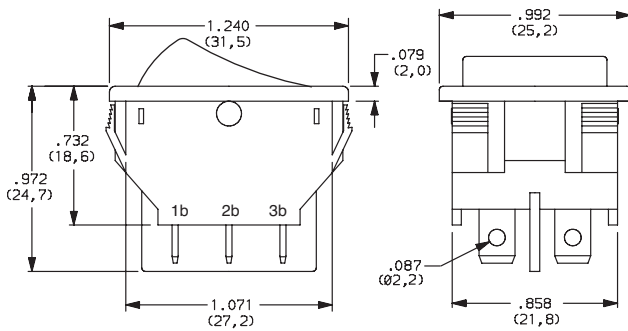

**NOTE:** Available with 15 termination and Q contact rating only.

Shown in Pos. 1

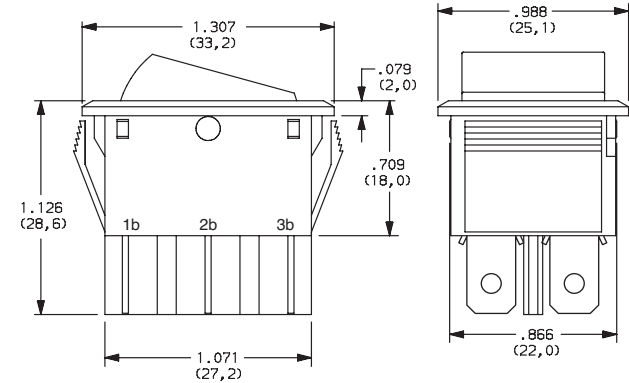

**NOTE:** Available with 05 termination and QA contact rating only.

Shown in Pos. 1

### PANEL MOUNTING

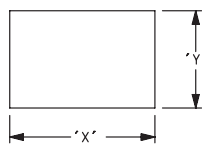

PANEL THICKNESS	"X"	"Y"
0.030-0.049 (0,75-1,25)	1.190-.004 (30,2-0,1)	0.874+.004 (22,2+0,1)
0.049-0.079 (1,25-2,0)	1.197-.004 (30,4-0,1)	0.874+.004 (22,2+0,1)
0.079-0.118 (2,0-3,0)	1.213-.004 (30,8-0,1)	0.874+.004 (22,2+0,1)

## TERMINATION

**15** .187" QUICK CONNECT

**05** .250" QUICK CONNECT

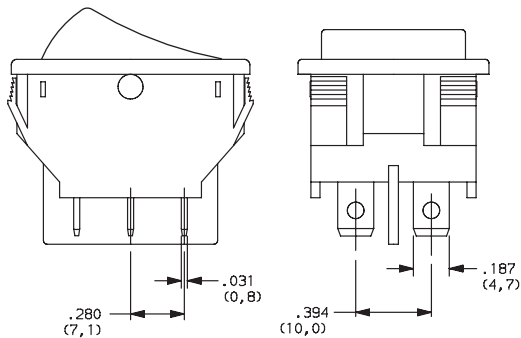

**NOTE:** Available with S1 & S2 mounting style and Q contact rating only.

Shown in Pos. 1

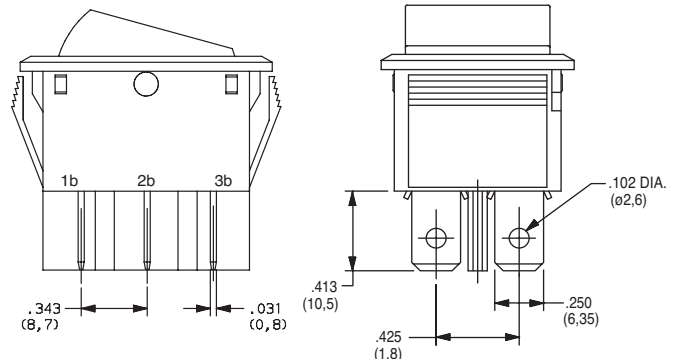

**NOTE:** Available with S3 & S4 mounting styles and QA contact rating, CN201 & CN202 switch functions only.

Shown in Pos. 1



Dimensions are shown: Inches (mm)  
Specifications and dimensions subject to change

**C&K**



# CN Series Double Pole Power Rocker Switches

## ACTUATOR MARKING



**NONE** NO MARKING



**D** ON-OFF

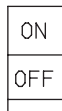

**H** O-I

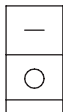

**P** O-

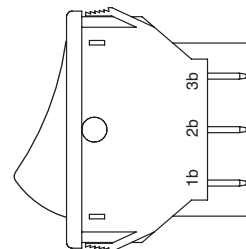

**NOTE:** Orientation of actuator marking and terminals.  
Shown in Pos. 1

## CONTACT MATERIAL



OPTION CODE	CONTACT AND TERMINAL MATERIAL	RATINGS	
<b>Q</b>	SILVER	POWER	16A @ 125C 1/3 HP @ 125 V AC
<b>QA</b>			10A @ 250 V AC 1/2HP @ 250 V AC
			16A @ 125 VAC, 1/8 HP @ 125 V AC; 10 A @ 250 VAC, 1/3 HP @ 250 V AC

\* Note: See Technical Data section of this catalog for RoHS compliant and compatible definitions and specifications.



## LAMP RATING



**(NONE)** NO LAMP

**7** 125 VAC 33kΩ NEON

**8** 250 VAC 150kΩ NEON

**NOTE:** Lamp rating for J3 & J8 actuator options.

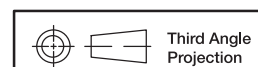

Dimensions are shown: Inches (mm)  
Specifications and dimensions subject to change

# CA Series Power Rocker Switches

## Features/Benefits

- 15 AMPS @ 125 V AC
- Cosmetic slimline detail
- Positive detent

## Typical Applications

- Hair dryers and other small appliances
- HVAC and other large appliances
- RoHS compliant

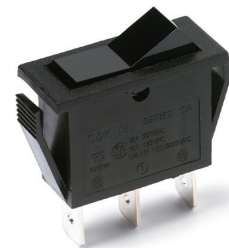

## Specifications

CONTACT RATING: 15 AMPS @ 125 V AC;  
10 AMPS @ 250 V AC;  
1/4 HP @ 125 V AC or 250 V AC

ELECTRICAL LIFE: 10,000 make-and-break cycles at full load.

INSULATION RESISTANCE:  $10^9 \Omega$  min.

DIELECTRIC STRENGTH: 1,000 Vrms min. @ sea level.

OPERATING TEMPERATURE: -30°C to +65°C

## Materials

HOUSING: 6/6 nylon (UL 94V-2), black.

ACTUATOR: Polycarbonate (UL 94V-2), black.

CONTACTS: Coin silver, silver plated.

TERMINALS: Copper, silver plated.

CONTACT SPRING: Music wire.

**NOTE:** Specifications and material listed above are for switches with standard options. For information on specific and custom switches, consult Customer Service Center.

## Build-A-Switch

To order, simply select desired option from each category and place in the appropriate box. Available options are shown and described on pages G-106 through G-108. For additional options not shown in catalog, consult Customer Service Center.

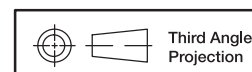
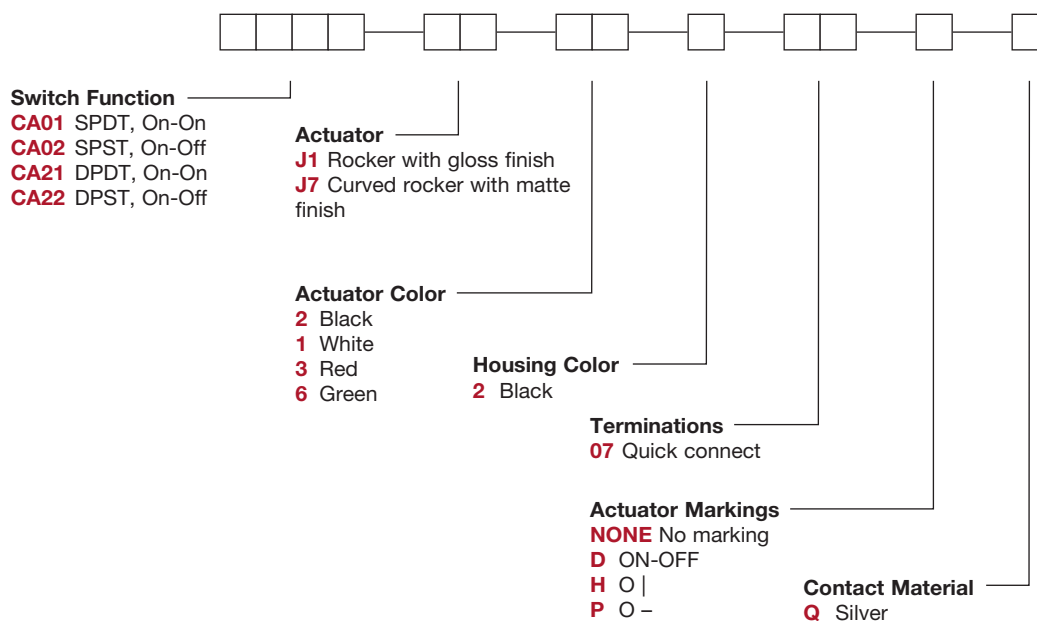

Dimensions are shown: Inches (mm)  
Specifications and dimensions subject to change



# CA Series Power Rocker Switches

## SWITCH FUNCTION



NO. POLES	MODEL NO.	SWITCH FUNCTION		CONNECTED TERMINALS		SCHEMATIC
		POS. 1	POS. 2	POS. 1	POS. 2	
SP	<b>CA01</b>	ON	ON	1-1A	1-1B	SPDT
	<b>CA02</b>	ON	OFF	1-1A	OPEN	SPST

### SPST

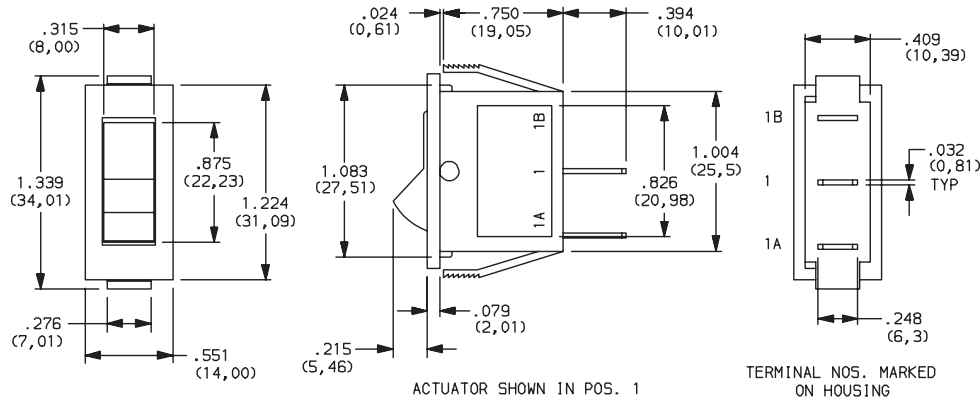

NO. POLES	MODEL NO.	SWITCH FUNCTION		CONNECTED TERMINALS		SCHEMATIC
		POS. 1	POS. 2	POS. 1	POS. 2	
DP	<b>CA21</b>	ON	ON	1-1A, 2-2A	1-1B, 2-2B	DPDT
	<b>CA22</b>	ON	OFF	1-1A, 2-2A	OPEN	DPST

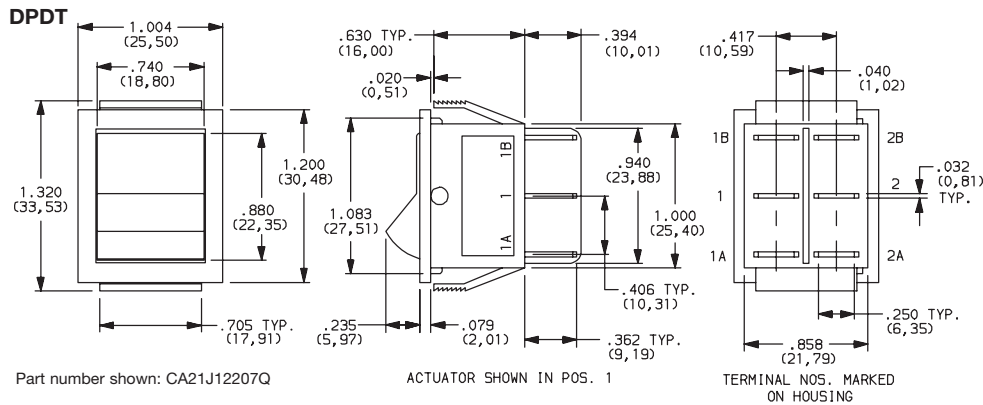

For complete contact ratings and agency approvals, see CONTACT MATERIAL section, page G-108.  
Contacts make on side opposite actuator thrown.

All models cRU US with all options.

Rocker



Third Angle  
Projection

Dimensions are shown: Inches (mm)  
Specifications and dimensions subject to change



# CA Series Power Rocker Switches

## ACTUATOR



### J1 ROCKER WITH GLOSS FINISH

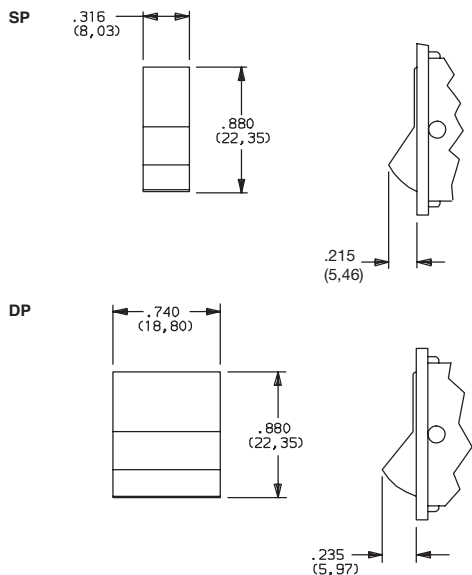

### J7 CURVED ROCKER WITH MATTE FINISH

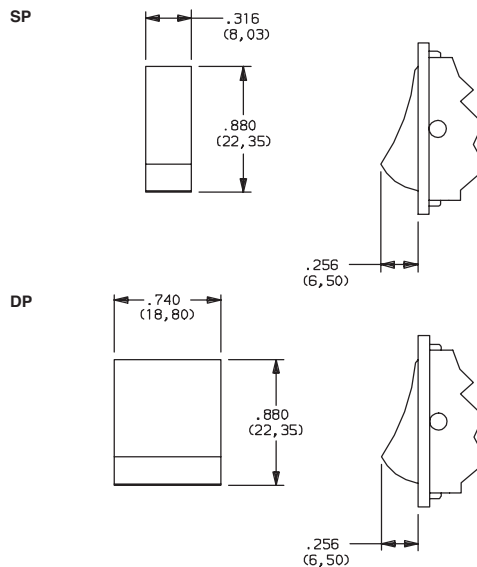

## ACTUATOR COLOR



OPTION CODE	OPAQUE ACTUATOR COLOR
1	WHITE
2	BLACK
3	RED
6	GREEN

**NOTE:** Actuator finish: matte. Special colors available, consult Customer Service Center.

## HOUSING COLOR



OPTION CODE	HOUSING COLOR
2	BLACK

**NOTE:** Housing frame finish: matte.

## TERMINATIONS

### 07 QUICK CONNECT

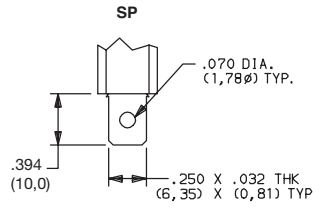

### PANEL MOUNTING

J1, & J7 only

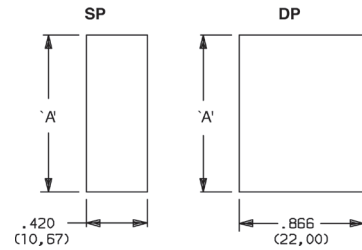

PANEL THICKNESS	DIM 'A'
.059-.078 (1,50) (2,00)	1.102 (28,00)
.078-.118 (2,00) (3,00)	1.110 (28,20)
.118-.177 (3,00) (4,50)	1.126 (28,60)

## ACTUATOR MARKINGS

**NONE** NO MARKING



**D** ON-OFF

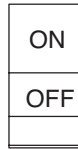

**H** O |



**P** O -

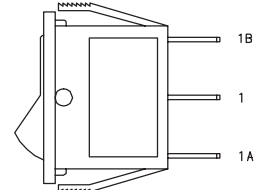

Marking color white, standard for all actuator colors except white and yellow. Marking color black, standard for white and yellow actuators. Consult Customer Service Center for other available markings and colors.

**NOTE:** Orientation of actuator markings and terminals

## CONTACT MATERIAL

OPTION CODE	CONTACT AND TERMINAL MATERIAL	RATINGS		
<b>Q</b>	SILVER <sup>1</sup>	POWER	10 AMPS @ 250 VAC 15 AMPS @ 125 VAC 1/4 HP 125/250 VAC	

\* Note: See Technical Data section of this catalog for RoHS compliant and compatible definitions and specifications.

<sup>1</sup> CONTACTS: Coin silver, silver plated.  
TERMINALS: Copper, silver plated.

All models with all options.

# CA Series Illuminated Power Rocker Switches

## Features/Benefits

- 15 AMPS @ 125 V AC
- Illuminated actuator
- Various actuator styles

## Typical Applications

- Power outlet strips
- Appliances
- Handling and packaging machines
- RoHS compliant



## Specifications

CONTACT RATING: 15 AMPS @ 125 V AC; 10 AMPS @ 250 V AC; 1/4 HP @ 125 V AC or 250 V AC.

ELECTRICAL LIFE: 10,000 make-and-break cycles at full load.

LAMP LIFE: 20,000 hours typ.

INSULATION RESISTANCE:  $10^9 \Omega$  min.

DIELECTRIC STRENGTH: 1,000 Vrms min. @ sea level.

## Materials

HOUSING: 6/6 nylon (UL 94V-2), black.

ACTUATOR: Polycarbonate (UL 94V-2), red.

CONTACTS: Coin silver, silver plated.

OPERATING TEMPERATURE: -30°C to +65°C

**NOTE:** Specifications and materials listed above are for switches with standard options. For information on specific and custom switches, consult Customer Service Center.

## Build-A-Switch

To order, simply select desired option from each category and place in the appropriate box. Available options are shown and described on pages G-103 through G-105. For additional options not shown in catalog, consult Customer Service Center.

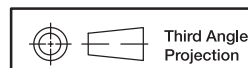
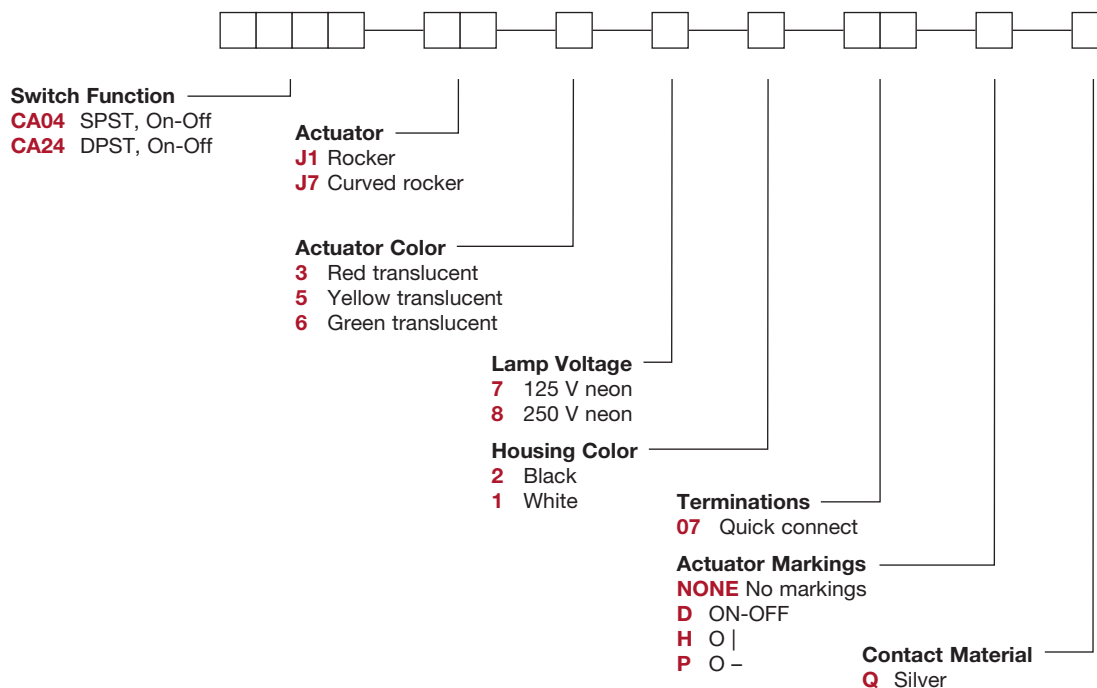

Dimensions are shown: Inches (mm)  
Specifications and dimensions subject to change



# CA Series Illuminated Power Rocker Switches

## SWITCH FUNCTION

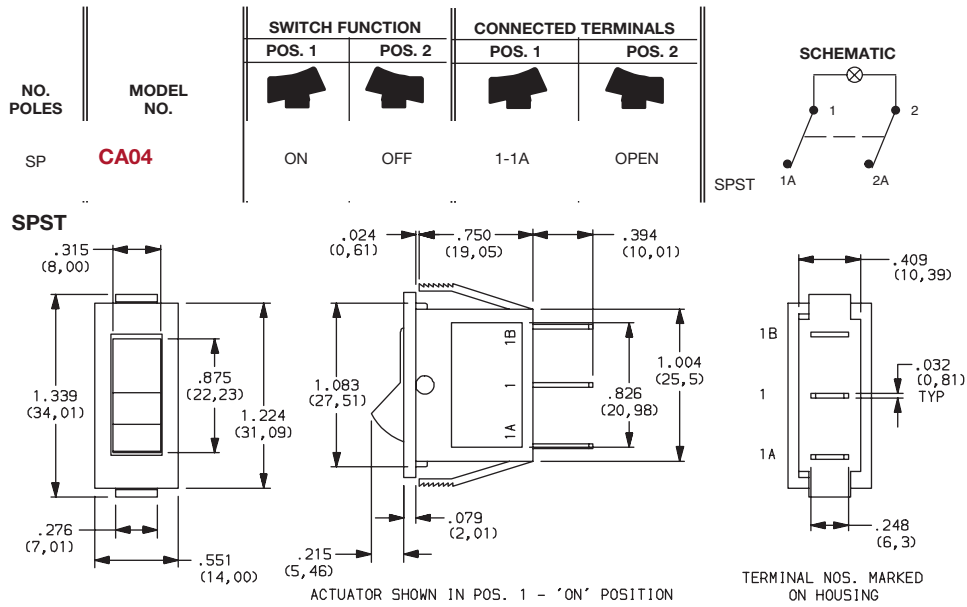

Part number shown: CA04J137207Q

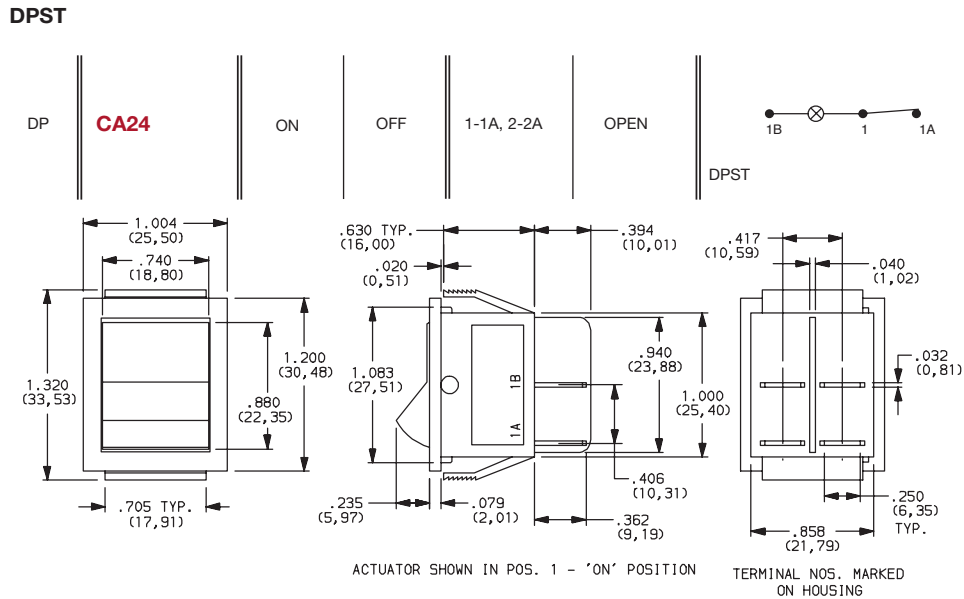

Part number shown: CA24J137207Q

See CONTACT MATERIAL section, page G-105, for complete contact ratings and agency approvals. Contacts make on side opposite actuator throw.

All models with all options.

Rocker



G

**C&K**



Third Angle Projection  
Dimensions are shown: Inches (mm)  
Specifications and dimensions subject to change



# CA Series Illuminated Power Rocker Switches

## ACTUATOR



### J1 ROCKER

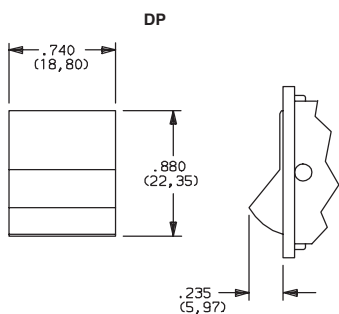
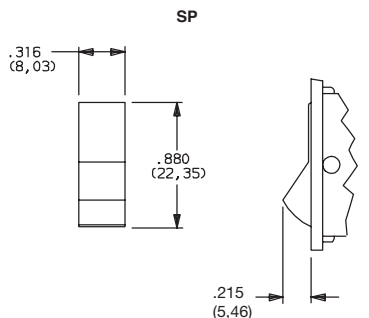

### J7 CURVED ROCKER

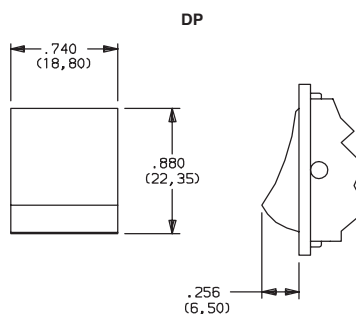
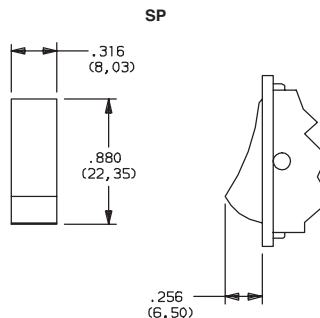

## ACTUATOR COLOR



OPTION CODE	ACTUATOR COLOR
<b>3</b>	RED TRANSLUCENT
<b>5</b>	YELLOW
<b>6</b>	GREEN

**NOTE:** Special colors available, consult Customer Service Center.

## NEON LAMP VOLTAGE



- 7** 125 V NEON
- 8** 250 V NEON

## HOUSING COLOR



OPTION CODE	HOUSING COLOR
<b>2</b>	BLACK
<b>1</b>	WHITE

**NOTE:** Housing frame finish: matte. Special colors available, consult Customer Service Center.



Dimensions are shown: Inches (mm)  
Specifications and dimensions subject to change



# CA Series Illuminated Power Rocker Switches

## TERMINATIONS

### 07 QUICK CONNECT

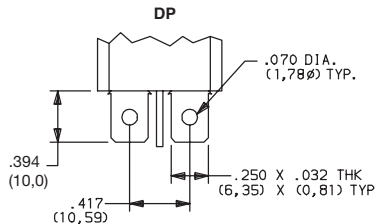
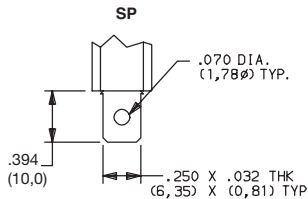

### PANEL MOUNTING

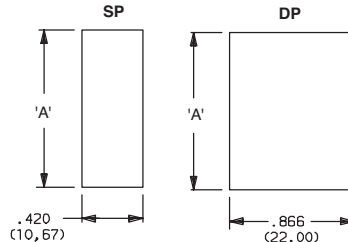

PANEL THICKNESS	DIM 'A'
.059-.078 (1,50) (2,00)	1.102 (28,00)
.078-.118 (2,00) (3,00)	1.110 (28,20)
.118-.177 (3,00) (4,50)	1.126 (28,60)

## ACTUATOR MARKINGS

**NONE** NO MARKING



**D** ON-OFF

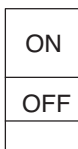

**H** O I



**P** O -

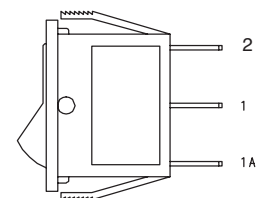

**NOTE:** Orientation of actuator markings and terminals

Marking color white, standard for all actuator colors except yellow. Marking color black, standard for yellow actuators. Consult Customer Service Center for other available markings and colors.

## CONTACT MATERIAL

OPTION CODE	CONTACT AND TERMINAL MATERIAL	RATINGS	
<b>Q</b>	SILVER <sup>1</sup>	POWER	10 AMPS @ 250 VAC 15 AMPS @ 125 VAC 1/4 HP 125/250 VAC



\* Note: See Technical Data section of this catalog for RoHS compliant and compatible definitions and specifications.

<sup>1</sup> CONTACTS: Coin silver, silver plated.  
TERMINALS: Copper, silver plated.

All models  with all options.





## Стандарт Электрон Связь

Мы молодая и активно развивающаяся компания в области поставок электронных компонентов. Мы поставляем электронные компоненты отечественного и импортного производства напрямую от производителей и с крупнейших складов мира.

Благодаря сотрудничеству с мировыми поставщиками мы осуществляем комплексные и плановые поставки широчайшего спектра электронных компонентов.

Собственная эффективная логистика и склад в обеспечивает надежную поставку продукции в точно указанные сроки по всей России.

Мы осуществляем техническую поддержку нашим клиентам и предпродажную проверку качества продукции. На все поставляемые продукты мы предоставляем гарантию .

Осуществляем поставки продукции под контролем ВП МО РФ на предприятия военно-промышленного комплекса России , а также работаем в рамках 275 ФЗ с открытием отдельных счетов в уполномоченном банке. Система менеджмента качества компании соответствует требованиям ГОСТ ISO 9001.

Минимальные сроки поставки, гибкие цены, неограниченный ассортимент и индивидуальный подход к клиентам являются основой для выстраивания долгосрочного и эффективного сотрудничества с предприятиями радиоэлектронной промышленности, предприятиями ВПК и научно-исследовательскими институтами России.

С нами вы становитесь еще успешнее!

### Наши контакты:

**Телефон:** +7 812 627 14 35

**Электронная почта:** [sales@st-electron.ru](mailto:sales@st-electron.ru)

**Адрес:** 198099, Санкт-Петербург,  
Промышленная ул, дом № 19, литера Н,  
помещение 100-Н Офис 331