

FEATURES

- Linear-in-dB gain control
- Pin-programmable gain ranges
 - 11 dB to +31 dB with 90 MHz bandwidth
 - 9 dB to 51 dB with 9 MHz bandwidth
- Any intermediate range, for example –1 dB to +41 dB with 30 MHz bandwidth
- Bandwidth independent of variable gain
- 1.3 nV/ $\sqrt{\text{Hz}}$ input noise spectral density
- ± 0.5 dB typical gain accuracy

APPLICATIONS

- RF/IF AGC amplifiers
- Video gain controls
- A/D range extensions
- Signal measurements

GENERAL DESCRIPTION

The AD603 is a low noise, voltage-controlled amplifier for use in RF and IF AGC systems. It provides accurate, pin-selectable gains of –11 dB to +31 dB with a bandwidth of 90 MHz or +9 dB to 51+ dB with a bandwidth of 9 MHz. Any intermediate gain range may be arranged using one external resistor. The input referred noise spectral density is only 1.3 nV/ $\sqrt{\text{Hz}}$, and power consumption is 125 mW at the recommended ± 5 V supplies.

The decibel gain is linear in dB, accurately calibrated, and stable over temperature and supply. The gain is controlled at a high impedance (50 M Ω), low bias (200 nA) differential input; the scaling is 25 mV/dB, requiring a gain control voltage of only 1 V to span the central 40 dB of the gain range. An overrange and underrange of 1 dB is provided whatever the selected range. The gain control response time is less than 1 μs for a 40 dB change.

The differential gain control interface allows the use of either differential or single-ended positive or negative control voltages. Several of these amplifiers may be cascaded and their gain control gains offset to optimize the system SNR.

The AD603 can drive a load impedance as low as 100 Ω with low distortion. For a 500 Ω load in shunt with 5 pF, the total harmonic distortion for a ± 1 V sinusoidal output at 10 MHz is typically –60 dBc. The peak specified output is ± 2.5 V minimum into a 500 Ω load.

The AD603 uses a patented proprietary circuit topology—the X-AMP[®]. The X-AMP comprises a variable attenuator of 0 dB to –42.14 dB followed by a fixed-gain amplifier. Because of the attenuator, the amplifier never has to cope with large inputs and can use negative feedback to define its (fixed) gain and dynamic performance. The attenuator has an input resistance of 100 Ω , laser trimmed to $\pm 3\%$, and comprises a 7-stage R-2R ladder network, resulting in an attenuation between tap points of 6.021 dB. A proprietary interpolation technique provides a continuous gain control function that is linear in dB.

The AD603 is specified for operation from –40°C to +85°C.

FUNCTIONAL BLOCK DIAGRAM

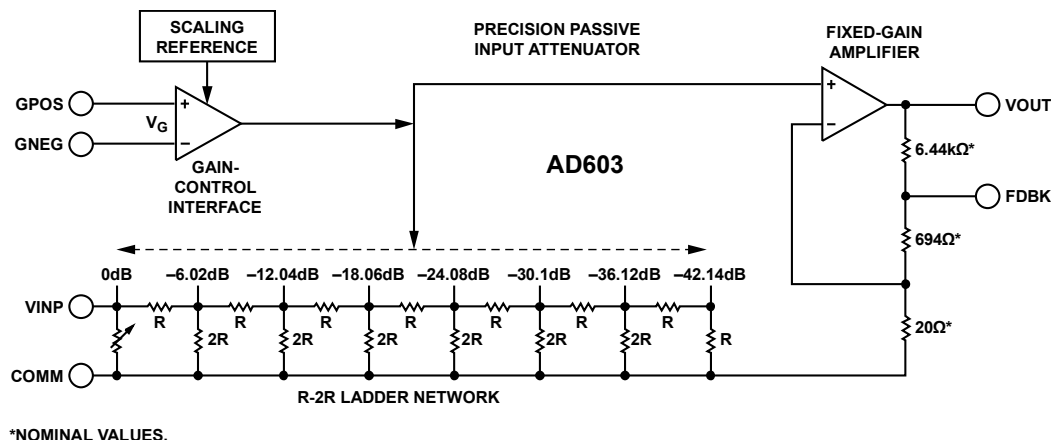

Figure 1.

Rev. K

Information furnished by Analog Devices is believed to be accurate and reliable. However, no responsibility is assumed by Analog Devices for its use, nor for any infringements of patents or other rights of third parties that may result from its use. Specifications subject to change without notice. No license is granted by implication or otherwise under any patent or patent rights of Analog Devices. Trademarks and registered trademarks are the property of their respective owners.

TABLE OF CONTENTS

| | |
|--|----|
| Features | 1 |
| Applications..... | 1 |
| General Description | 1 |
| Functional Block Diagram | 1 |
| Revision History | 2 |
| Specifications..... | 3 |
| Absolute Maximum Ratings..... | 4 |
| ESD Caution..... | 4 |
| Pin Configurations and Function Descriptions | 5 |
| Typical Performance Characteristics | 6 |
| Test Circuits..... | 11 |
| Theory of Operation | 12 |
| Noise Performance | 12 |

REVISION HISTORY

4/12—Rev. J to Rev. K

| | |
|--|----|
| Changes to Table 1..... | 3 |
| Added Figure 10 and Figure 11; Renumbered Sequentially | 7 |
| Added Test Circuits Section..... | 11 |
| Moved Figure 29 and Figure 30 | 11 |

12/11—Rev. I to Rev. J

| | |
|---|----|
| Changes to Figure 1 | 1 |
| Changes to Evaluation Board Section..... | 19 |
| Changes to Figure 48 Through Figure 50..... | 19 |
| Changes to Figure 51 Through Figure 54..... | 20 |
| Added Figure 57..... | 22 |

5/07—Rev. G to Rev. H

| | |
|--|----|
| Changes to Layout | 14 |
| Changes to Layout | 15 |
| Changes to Layout | 16 |
| Inserted Evaluation Board Section, and Figure 48 to Figure 51 | 19 |
| Inserted Figure 52 and Table 4..... | 20 |
| Changes to Ordering Guide | 21 |

| | |
|--|----|
| The Gain Control Interface..... | 13 |
| Programming the Fixed-Gain Amplifier Using Pin Strapping..... | 13 |
| Using the AD603 in Cascade | 15 |
| Sequential Mode (Optimal SNR) | 15 |
| Parallel Mode (Simplest Gain Control Interface) | 16 |
| Low Gain Ripple Mode (Minimum Gain Error) | 17 |
| Applications Information | 18 |
| A Low Noise AGC Amplifier | 18 |
| Caution | 19 |
| Evaluation Board | 20 |
| Outline Dimensions..... | 22 |
| Ordering Guide | 23 |

3/05—Rev. F to Rev. G

| | |
|---|-----------|
| Updated Format..... | Universal |
| Change to Features..... | 1 |
| Changes to General Description | 1 |
| Change to Figure 1 | 1 |
| Changes to Specifications..... | 3 |
| New Figure 4 and Renumbering Subsequent Figures | 6 |
| Change to Figure 10 | 7 |
| Change to Figure 23 | 9 |
| Change to Figure 29 | 12 |
| Updated Outline Dimensions..... | 20 |

4/04—Rev. E to Rev. F

| | |
|---------------------------------|---|
| Changes to Specifications..... | 2 |
| Changes to Ordering Guide | 3 |

8/03—Rev. D to Rev. E

| | |
|---|-----------|
| Updated Format..... | Universal |
| Changes to Specifications..... | 2 |
| Changes to TPCs 2, 3, 4..... | 4 |
| Changes to Sequential Mode (Optimal S/N Ratio) section..... | 9 |
| Change to Figure 8 | 10 |
| Updated Outline Dimensions..... | 14 |

SPECIFICATIONS

@ $T_A = 25^\circ\text{C}$, $V_S = \pm 5\text{ V}$, $-500\text{ mV} \leq V_G \leq +500\text{ mV}$, $\text{GNEG} = 0\text{ V}$, -10 dB to $+30\text{ dB}$ gain range, $R_L = 500\ \Omega$, and $C_L = 5\text{ pF}$, unless otherwise noted.

Table 1.

| Parameter | Conditions | Min | Typ | Max | Unit |
|--|--|------------|-----------|-----------|------------------------|
| INPUT CHARACTERISTICS | | | | | |
| Input Resistance | Pin 3 to Pin 4 | 97 | 100 | 103 | Ω |
| Input Capacitance | | | 2 | | pF |
| Input Noise Spectral Density ¹ | Input short-circuited | | 1.3 | | nV/ $\sqrt{\text{Hz}}$ |
| Noise Figure | $f = 10\text{ MHz}$, gain = maximum, $R_S = 10\ \Omega$ | | 8.8 | | dB |
| 1 dB Compression Point | $f = 10\text{ MHz}$, gain = maximum, $R_S = 10\ \Omega$ | | -11 | | dBm |
| Peak Input Voltage | | | ± 1.4 | ± 2 | V |
| OUTPUT CHARACTERISTICS | | | | | |
| -3 dB Bandwidth | $V_{\text{OUT}} = 100\text{ mV rms}$ | | 90 | | MHz |
| Slew Rate | $R_L \geq 500\ \Omega$ | | 275 | | V/ μs |
| Peak Output ² | $R_L \geq 500\ \Omega$ | ± 2.5 | ± 3.0 | | V |
| Output Impedance | $f \leq 10\text{ MHz}$ | | 2 | | Ω |
| Output Short-Circuit Current | | | 50 | | mA |
| Group Delay Change vs. Gain | $f = 3\text{ MHz}$; full gain range | | ± 2 | | ns |
| Group Delay Change vs. Frequency | $V_G = 0\text{ V}$; $f = 1\text{ MHz}$ to 10 MHz | | ± 2 | | ns |
| Differential Gain | | | 0.2 | | % |
| Differential Phase | | | 0.2 | | Degree |
| Total Harmonic Distortion | $f = 10\text{ MHz}$, $V_{\text{OUT}} = 1\text{ V rms}$ | | -60 | | dBc |
| Third-Order Intercept | $f = 40\text{ MHz}$, gain = maximum, $R_S = 50\ \Omega$ | | 15 | | dBm |
| ACCURACY | | | | | |
| Gain Accuracy, $f = 100\text{ kHz}$; Gain (dB) = $(40V_G + 10)\text{ dB}$ | $-500\text{ mV} \leq V_G \leq +500\text{ mV}$ | -1 | ± 0.5 | +1 | dB |
| T_{MIN} to T_{MAX} | | -1.5 | | +1.5 | dB |
| Gain, $f = 10.7\text{ MHz}$ | $V_G = -0.5\text{ V}$ | -10.3 | -9.0 | -8.0 | dB |
| | $V_G = 0.0\text{ V}$ | +9.5 | +10.5 | +11.5 | dB |
| | $V_G = 0.5\text{ V}$ | +29.3 | +30.3 | +31.3 | dB |
| | $V_G = 0\text{ V}$ | | 20 | | mV |
| Output Offset Voltage ³ | | | 30 | | mV |
| T_{MIN} to T_{MAX} | | | 20 | | mV |
| Output Offset Variation vs. V_G | $-500\text{ mV} \leq V_G \leq +500\text{ mV}$ | | | 20 | mV |
| T_{MIN} to T_{MAX} | | | | 30 | mV |
| GAIN CONTROL INTERFACE | | | | | |
| Gain Scaling Factor | 100 kHz | 39.4 | 40 | 40.6 | dB/V |
| T_{MIN} to T_{MAX} | | 38 | | 42 | dB/V |
| | 10.7 MHz | 38.7 | 39.3 | 39.9 | dB/V |
| GNEG, GPOS Voltage Range ⁴ | | -1.2 | | +2.0 | V |
| Input Bias Current | | 50 | 100 | 250 | nA |
| Input Offset Current | | | 10 | | nA |
| Differential Input Resistance | Pin 1 to Pin 2 | | 50 | | M Ω |
| Response Rate | Full 40 dB gain change | | 80 | | dB/ μs |
| POWER SUPPLY | | | | | |
| Specified Operating Range | | ± 4.75 | | ± 6.3 | V |
| Quiescent Current | | | 12.5 | 17 | mA |
| T_{MIN} to T_{MAX} | | | | 20 | mA |

¹ Typical open or short-circuited input; noise is lower when system is set to maximum gain and input is short-circuited. This figure includes the effects of both voltage and current noise sources.

² Using resistive loads of $500\ \Omega$ or greater or with the addition of a $1\text{ k}\Omega$ pull-down resistor when driving lower loads.

³ The dc gain of the main amplifier in the AD603 is $\times 35.7$; therefore, an input offset of $100\ \mu\text{V}$ becomes a 3.57 mV output offset.

⁴ GNEG and GPOS, gain control, and voltage range are guaranteed to be within the range of $-V_S + 4.2\text{ V}$ to $+V_S - 3.4\text{ V}$ over the full temperature range of -40°C to $+85^\circ\text{C}$.

ABSOLUTE MAXIMUM RATINGS

Table 2.

| Parameter | Rating |
|--------------------------------------|---|
| Supply Voltage $\pm V_S$ | ± 7.5 V |
| Internal Voltage VINP (Pin 3) | ± 2 V Continuous $\pm V_S$ for 10 ms |
| GPOS, GNEG (Pin 1 and Pin2) | $\pm V_S$ |
| Internal Power Dissipation | 400 mW |
| Operating Temperature Range | |
| AD603A | -40°C to $+85^\circ\text{C}$ |
| AD603S | -55°C to $+125^\circ\text{C}$ |
| Storage Temperature Range | -65°C to $+150^\circ\text{C}$ |
| Lead Temperature (Soldering, 60 sec) | 300°C |

Stresses above those listed under Absolute Maximum Ratings may cause permanent damage to the device. This is a stress rating only; functional operation of the device at these or any other conditions above those indicated in the operational section of this specification is not implied. Exposure to absolute maximum rating conditions for extended periods may affect device reliability.

Table 3. Thermal Characteristics

| Package Type | θ_{JA} | θ_{JC} | Unit |
|---------------|---------------|---------------|---------------------------|
| 8-Lead SOIC | 155 | 33 | $^\circ\text{C}/\text{W}$ |
| 8-Lead CERDIP | 140 | 15 | $^\circ\text{C}/\text{W}$ |

ESD CAUTION



ESD (electrostatic discharge) sensitive device. Charged devices and circuit boards can discharge without detection. Although this product features patented or proprietary protection circuitry, damage may occur on devices subjected to high energy ESD. Therefore, proper ESD precautions should be taken to avoid performance degradation or loss of functionality.

PIN CONFIGURATIONS AND FUNCTION DESCRIPTIONS

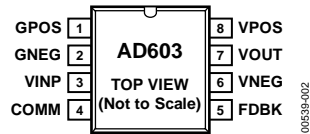

Figure 2. 8-Lead SOIC Pin Configuration

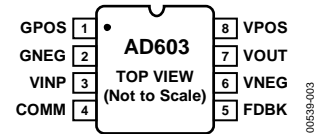

Figure 3. 8-Lead CERDIP Pin Configuration

Table 4. Pin Function Descriptions

| Pin No. | Mnemonic | Description |
|---------|----------|--|
| 1 | GPOS | Gain Control Input High (Positive Voltage Increases Gain). |
| 2 | GNEG | Gain Control Input Low (Negative Voltage Increases Gain). |
| 3 | VINP | Amplifier Input. |
| 4 | COMM | Amplifier Ground. |
| 5 | FDBK | Connection to Feedback Network. |
| 6 | VNEG | Negative Supply Input. |
| 7 | VOUT | Amplifier Output. |
| 8 | VPOS | Positive Supply Input. |

TYPICAL PERFORMANCE CHARACTERISTICS

@ $T_A = 25^\circ\text{C}$, $V_S = \pm 5\text{ V}$, $-500\text{ mV} \leq V_G \leq +500\text{ mV}$, $G_{NEG} = 0\text{ V}$, -10 dB to $+30\text{ dB}$ gain range, $R_L = 500\ \Omega$, and $C_L = 5\text{ pF}$, unless otherwise noted.

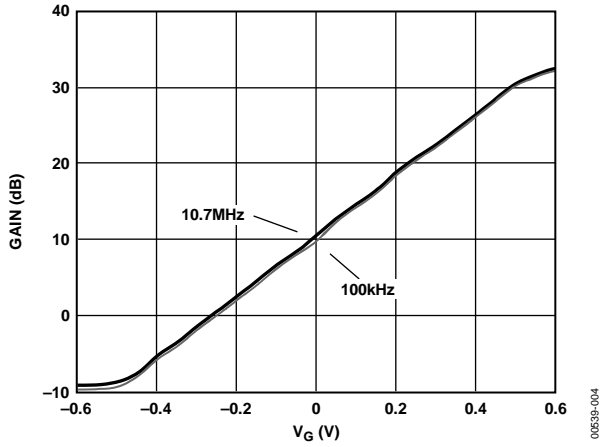

Figure 4. Gain vs. V_G at 100 kHz and 10.7 MHz

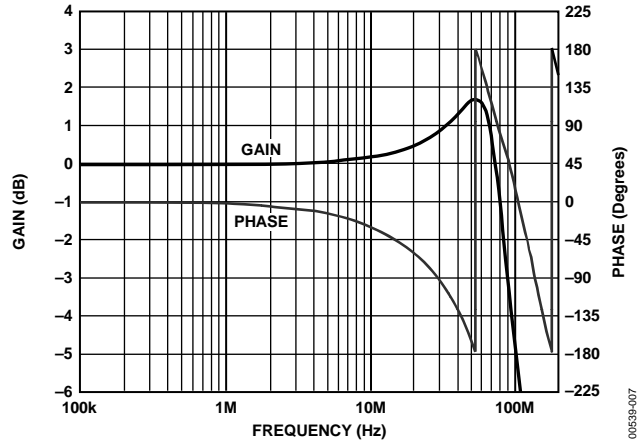

Figure 7. Frequency and Phase Response vs. Gain
(Gain = 10 dB, $P_{IN} = -30\text{ dBm}$)

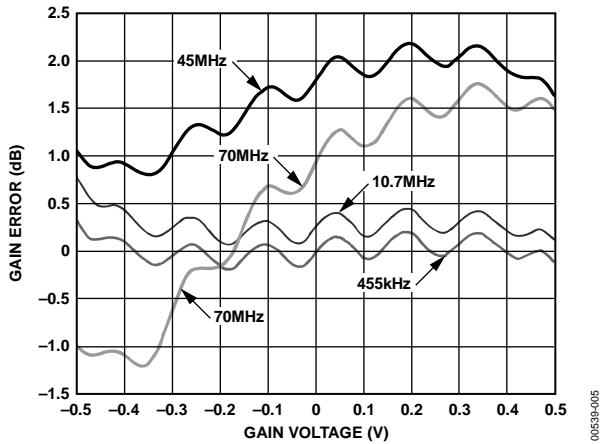

Figure 5. Gain Error vs. Gain Control Voltage at 455 kHz, 10.7 MHz, 45 MHz, 70 MHz

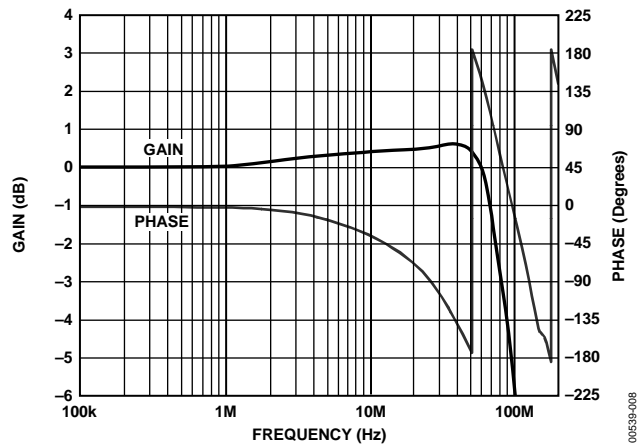

Figure 8. Frequency and Phase Response vs. Gain
(Gain = 30 dB, $P_{IN} = -30\text{ dBm}$)

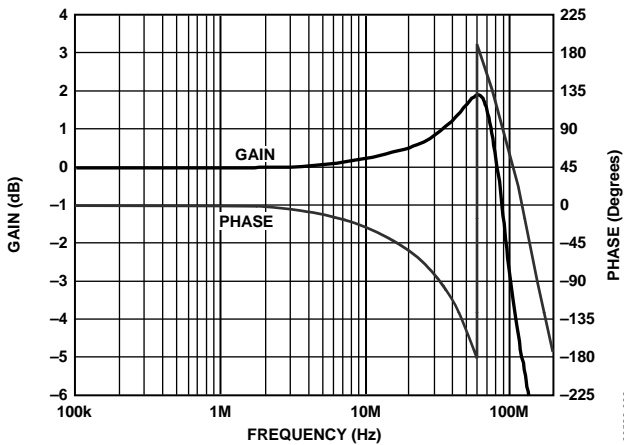

Figure 6. Frequency and Phase Response vs. Gain
(Gain = -10 dB, $P_{IN} = -30\text{ dBm}$)

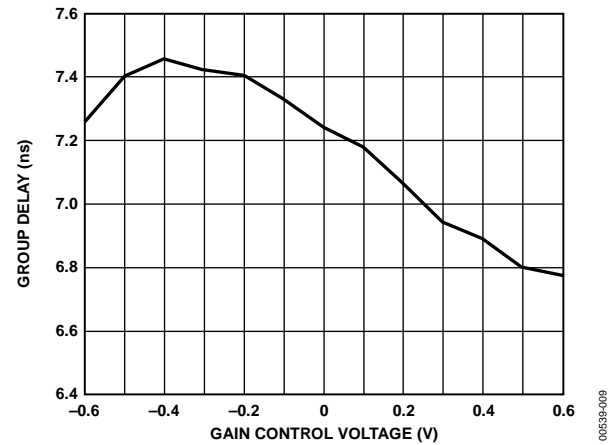

Figure 9. Group Delay vs. Gain Control Voltage

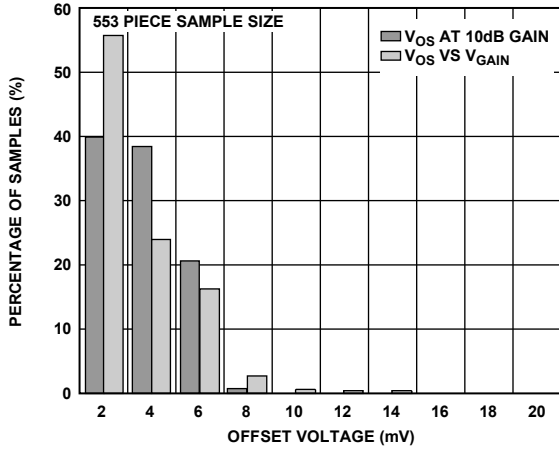

Figure 10. Histogram of V_{OS} at 10 dB Gain and V_{OS} vs. V_{GAIN}

00539-057

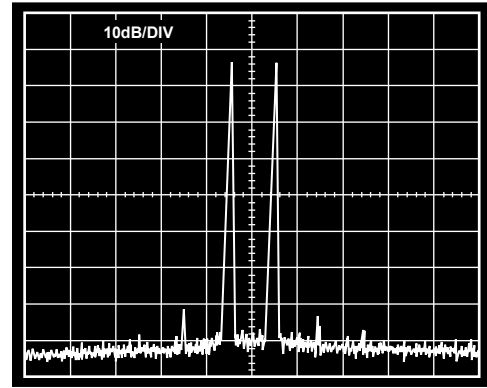

Figure 13. Third-Order Intermodulation Distortion at 10.7 MHz (10x Probe Used to HP3585A Spectrum Analyzer, Gain = 0 dB, P_{IN} = 0 dBm)

00539-012

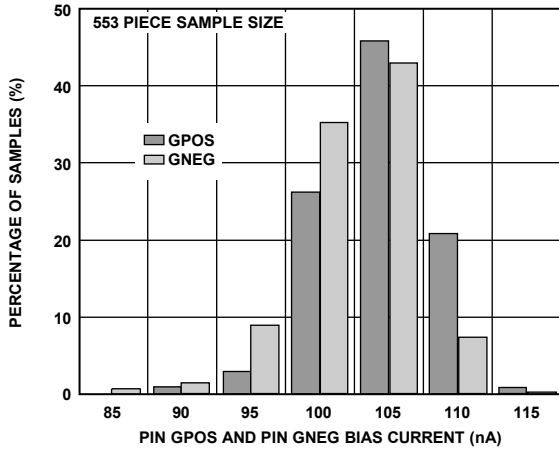

Figure 11. Histogram of GPOS and GNEG Bias Current

00539-058

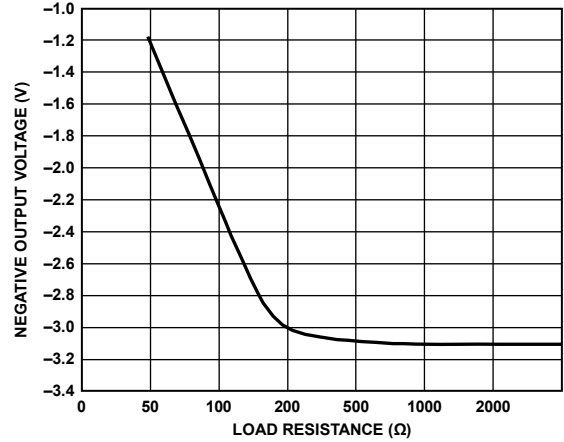

Figure 14. Typical Output Voltage Swing vs. Load Resistance (Negative Output Swing Limits First)

00539-013

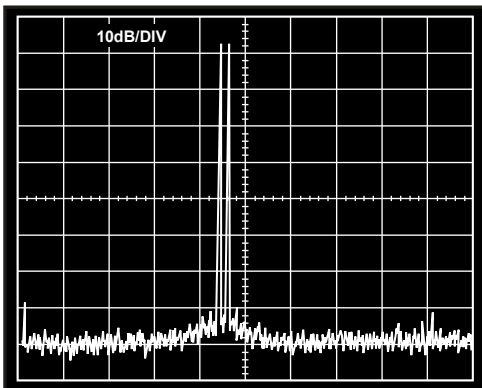

Figure 12. Third-Order Intermodulation Distortion at 455 kHz (10x Probe Used to HP3585A Spectrum Analyzer, Gain = 0 dB, P_{IN} = 0 dBm)

00539-011

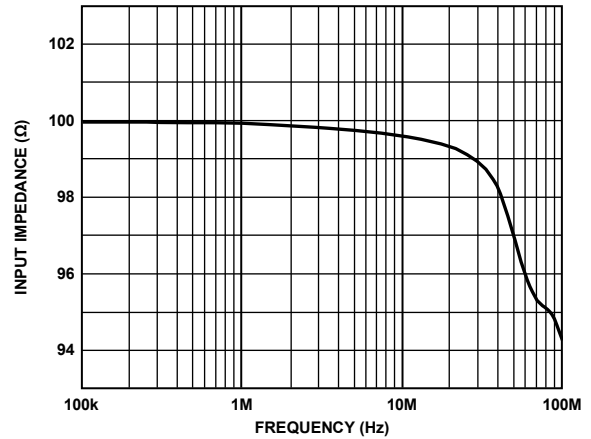

Figure 15. Input Impedance vs. Frequency (Gain = -10 dB)

00539-014

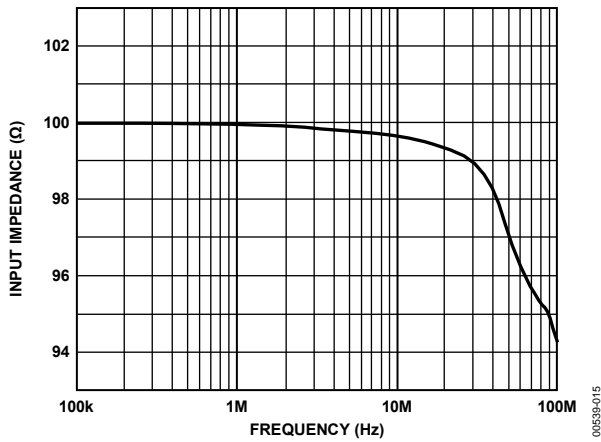

Figure 16. Input Impedance vs. Frequency (Gain = 10 dB)

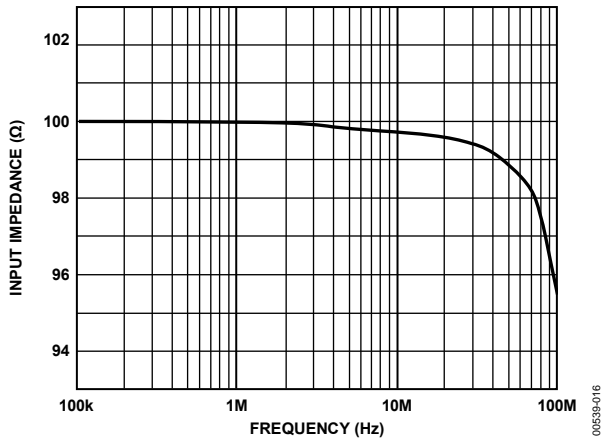

Figure 17. Input Impedance vs. Frequency (Gain = 30 dB)

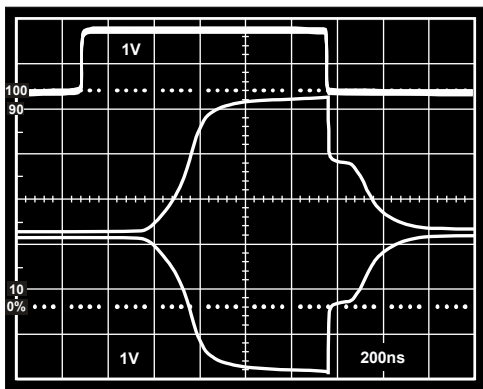

Figure 18. Gain Control Channel Response Time

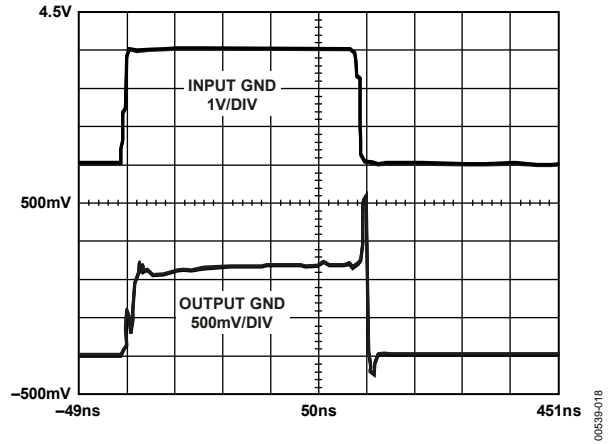

Figure 19. Input Stage Overload Recovery Time (Input Is 500 ns Period, 50% Duty-Cycle Square Wave, Output Is Captured Using Tektronix 11402 Digitizing Oscilloscope)

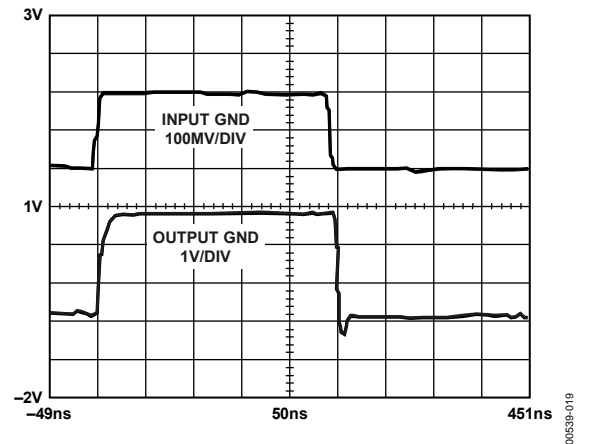

Figure 20. Output Stage Overload Recovery Time (Input Is 500 ns Period, 50% Duty-Cycle Square Wave, Output Is Captured Using Tektronix 11402 Digitizing Oscilloscope)

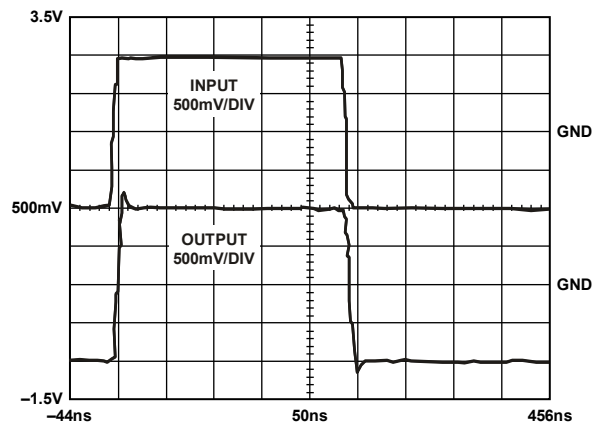

Figure 21. Transient Response, $G = 0$ dB (Input Is 500 ns Period, 50% Duty-Cycle Square Wave, Output Is Captured Using Tektronix 11402 Digitizing Oscilloscope)

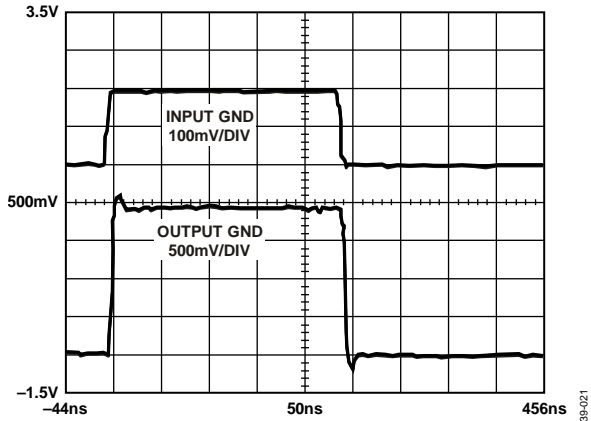

Figure 22. Transient Response, $G = 20 \text{ dB}$
 (Input Is 500 ns Period, 50% Duty-Cycle Square Wave,
 Output Is Captured Using Tektronix 11402 Digitizing Oscilloscope)

00539-021

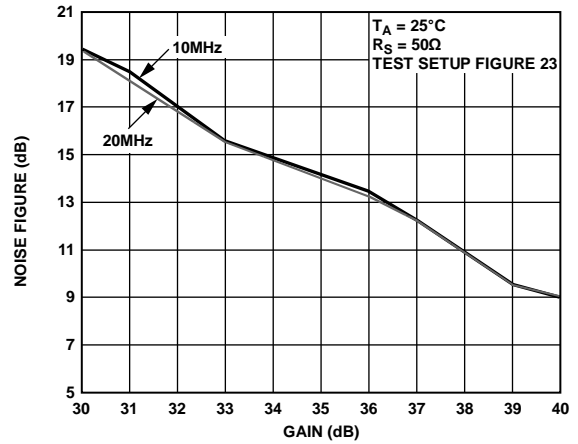

Figure 25. Noise Figure in 0 dB/40 dB Mode

00539-025

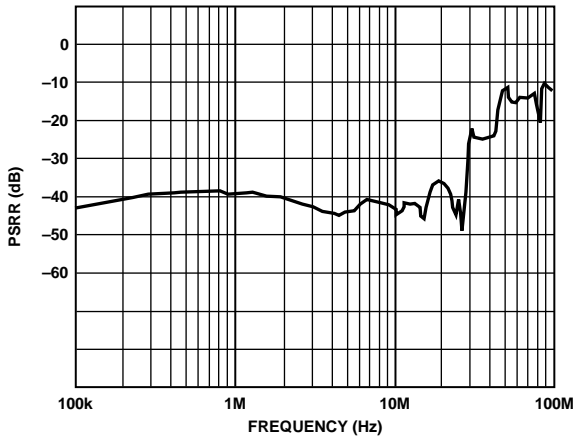

Figure 23. PSRR vs. Frequency
 (Worst Case Is Negative Supply PSRR, Shown Here)

00539-022

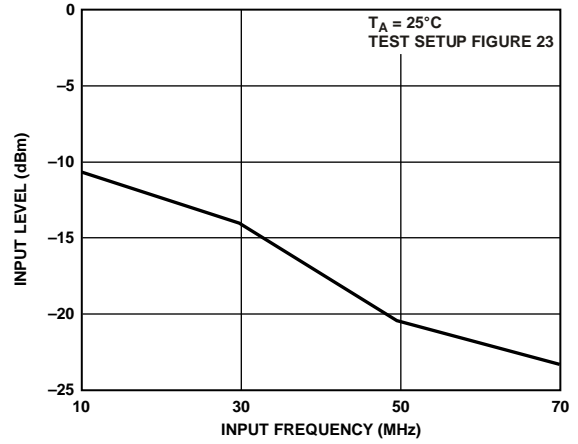

Figure 26. 1 dB Compression Point, $-10 \text{ dB}/+30 \text{ dB}$ Mode, Gain = 30 dB

00539-026

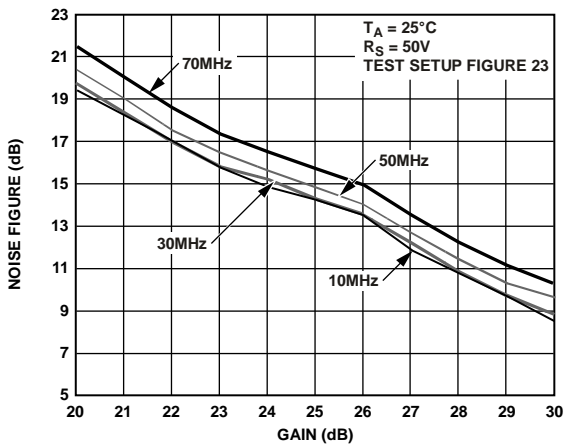

Figure 24. Noise Figure in $-10 \text{ dB}/+30 \text{ dB}$ Mode

00539-024

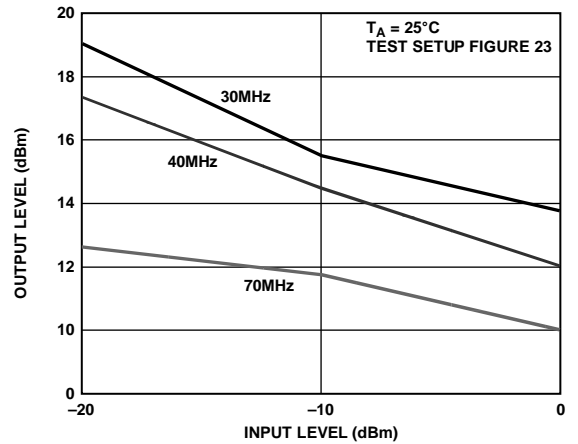

Figure 27. Third-Order Intercept $-10 \text{ dB}/+30 \text{ dB}$ Mode, Gain = 10 dB

00539-027

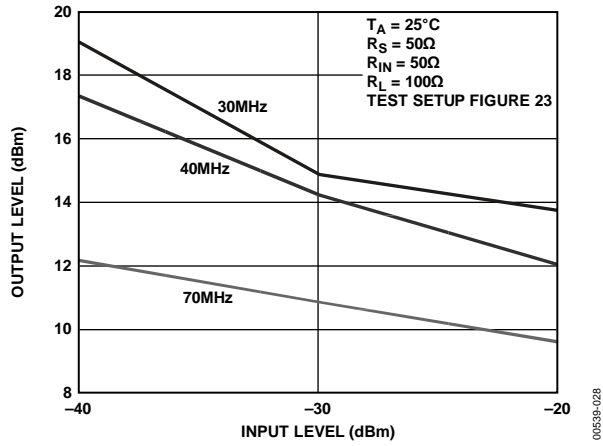
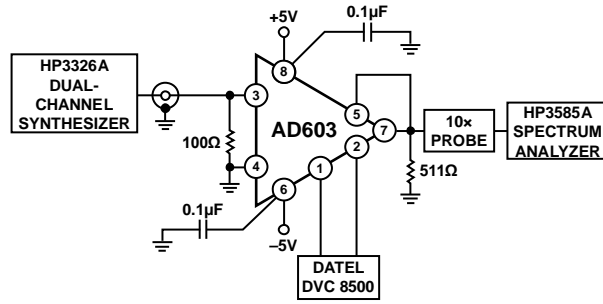

Figure 28. Third-Order Intercept -10 dB/+30 dB Mode, Gain = 30 dB

000598-028

TEST CIRCUITS



00538-010

Figure 29. Third-Order Intermodulation Distortion Test Setup

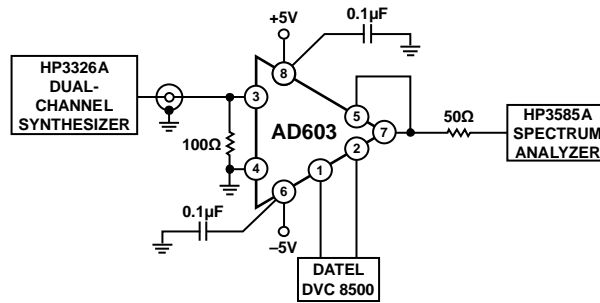

00539-023

Figure 30. Test Setup Used for Noise Figure, Third-Order Intercept, and 1 dB Compression Point Measurements

THEORY OF OPERATION

The AD603 comprises a fixed-gain amplifier, preceded by a broadband passive attenuator of 0 dB to 42.14 dB, having a gain control scaling factor of 40 dB per volt. The fixed gain is laser-trimmed in two ranges, to either 31.07 dB ($\times 35.8$) or 50 dB ($\times 358$), or it may be set to any range in between using one external resistor between Pin 5 and Pin 7. Somewhat higher gain can be obtained by connecting the resistor from Pin 5 to common, but the increase in output offset voltage limits the maximum gain to about 60 dB. For any given range, the bandwidth is independent of the voltage-controlled gain. This system provides an underrange and overrange of 1.07 dB in all cases; for example, the overall gain is -11.07 dB to $+31.07$ dB in the maximum bandwidth mode (Pin 5 and Pin 7 strapped).

This X-AMP structure has many advantages over former methods of gain control based on nonlinear elements. Most importantly, the fixed-gain amplifier can use negative feedback to increase its accuracy. Because large inputs are first attenuated, the amplifier input is always small. For example, to deliver a ± 1 V output in the -1 dB/ $+41$ dB mode (that is, using a fixed amplifier gain of 41.07 dB), its input is only 8.84 mV; therefore, the distortion can be very low. Equally important, the small-signal gain and phase response, and thus the pulse response, are essentially independent of gain.

Figure 31 is a simplified schematic. The input attenuator is a 7-section R-2R ladder network, using untrimmed resistors of nominally $R = 62.5 \Omega$, which results in a characteristic resistance of $125 \Omega \pm 20\%$. A shunt resistor is included at the input and laser trimmed to establish a more exact input resistance of $100 \Omega \pm 3\%$, which ensures accurate operation (gain and HP corner frequency) when used in conjunction with external resistors or capacitors.

The nominal maximum signal at input V_{INP} is 1 V rms (± 1.4 V peak) when using the recommended ± 5 V supplies, although operation to ± 2 V peak is permissible with some increase in HF distortion and feedthrough. Pin 4 (COMM) must be connected directly to the input ground; significant impedance in this connection reduces the gain accuracy.

The signal applied at the input of the ladder network is attenuated by 6.02 dB by each section; therefore, the attenuation to each of the taps is progressively 0 dB, 6.02 dB, 12.04 dB, 18.06 dB, 24.08 dB, 30.1 dB, 36.12 dB, and 42.14 dB. A unique circuit technique is employed to interpolate between these tap points, indicated by the slider in Figure 31, thus providing continuous attenuation from 0 dB to 42.14 dB. It helps in understanding the AD603 to think in terms of a mechanical means for moving this slider from left to right; in fact, its position is controlled by the voltage between Pin 1 and Pin 2. The details of the gain control interface are in the The Gain Control Interface section.

The gain is at all times very exactly determined, and a linear-in-dB relationship is automatically guaranteed by the exponential nature of the attenuation in the ladder network (the X-AMP principle). In practice, the gain deviates slightly from the ideal law, by about ± 0.2 dB peak (see, for example, Figure 5).

NOISE PERFORMANCE

An important advantage of the X-AMP is its superior noise performance. The nominal resistance seen at inner tap points is 41.7Ω (one third of 125Ω), which exhibits a Johnson noise spectral density (NSD) of $0.83 \text{ nV}/\sqrt{\text{Hz}}$ (that is, $\sqrt{4kTR}$) at 27°C , which is a large fraction of the total input noise. The first stage of the amplifier contributes a further $1 \text{ nV}/\sqrt{\text{Hz}}$, for a total input noise of $1.3 \text{ nV}/\sqrt{\text{Hz}}$. It is apparent that it is essential to use a low resistance in the ladder network to achieve the very low specified noise level. The source impedance of the signal forms a voltage divider with the 100Ω input resistance of the AD603. In some applications, the resulting attenuation may be unacceptable, requiring the use of an external buffer or preamplifier to match a high impedance source to the low impedance AD603.

The noise at maximum gain (that is, at the 0 dB tap) depends on whether the input is short-circuited or open-circuited. When short-circuited, the minimum NSD of slightly over $1 \text{ nV}/\sqrt{\text{Hz}}$ is achieved. When open-circuited, the resistance of 100Ω looking into the first tap generates $1.29 \text{ nV}/\sqrt{\text{Hz}}$, so the noise increases to $1.63 \text{ nV}/\sqrt{\text{Hz}}$. (This last calculation would be important if the AD603 were preceded by, for example, a 900Ω resistor to allow operation from inputs up to 10 V rms.) As the selected tap moves away from the input, the dependence of the noise on source impedance quickly diminishes.

Apart from the small variations just discussed, the signal-to-noise (SNR) at the output is essentially independent of the attenuator setting. For example, on the -11 dB/ $+31$ dB range, the fixed gain of $\times 35.8$ raises the output NSD to $46.5 \text{ nV}/\sqrt{\text{Hz}}$. Therefore, for the maximum undistorted output of 1 V rms and a 1 MHz bandwidth, the output SNR would be 86.6 dB, that is, $20 \log(1 \text{ V}/46.5 \mu\text{V})$.

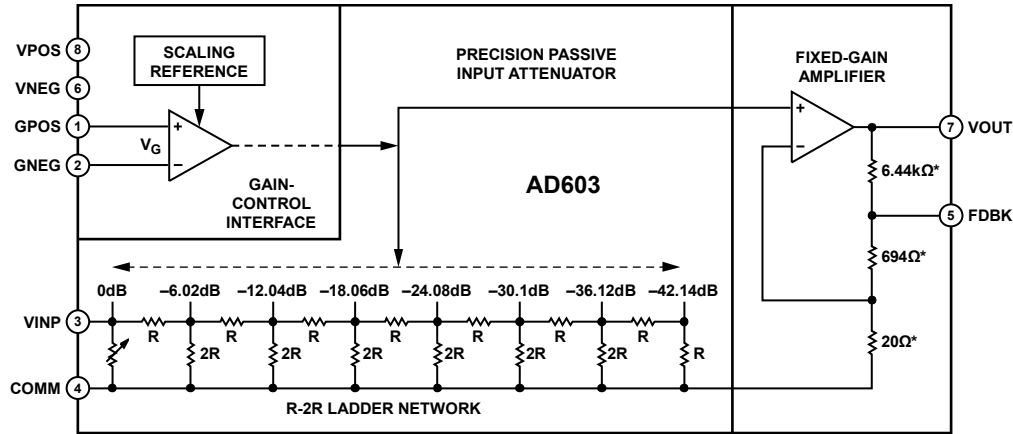

*NOMINAL VALUES.

00538-029

Figure 31. Simplified Block Diagram

THE GAIN CONTROL INTERFACE

The attenuation is controlled through a differential, high impedance (50 MΩ) input, with a scaling factor that is laser-trimmed to 40 dB per volt, that is, 25 mV/dB. An internal band gap reference ensures stability of the scaling with respect to supply and temperature variations.

When the differential input voltage $V_G = 0$ V, the attenuator slider is centered, providing an attenuation of 21.07 dB. For the maximum bandwidth range, this results in an overall gain of 10 dB (= -21.07 dB + 31.07 dB). When the control input is -500 mV, the gain is lowered by +20 dB (= 0.500 V × 40 dB/V) to -10 dB; when set to +500 mV, the gain is increased by +20 dB to +30 dB. When this interface is overdriven in either direction, the gain approaches either -11.07 dB (= -42.14 dB + 31.07 dB) or 31.07 dB (= 0 + 31.07 dB), respectively. The only constraint on the gain control voltage is that it be kept within the common-mode range (-1.2 V to +2.0 V assuming +5 V supplies) of the gain control interface.

The basic gain of the AD603 can therefore be calculated by

$$\text{Gain (dB)} = 40 V_G + 10 \tag{1}$$

where V_G is in volts. When Pin 5 and Pin 7 are strapped (see the Programming the Fixed-Gain Amplifier Using Pin Strapping section), the gain becomes

$$\text{Gain (dB)} = 40 V_G + 20 \text{ for } 0 \text{ to } +40 \text{ dB}$$

and

$$\text{Gain (dB)} = 40 V_G + 30 \text{ for } +10 \text{ to } +50 \text{ dB} \tag{2}$$

The high impedance gain control input ensures minimal loading when driving many amplifiers in multiple channel or cascaded applications. The differential capability provides flexibility in choosing the appropriate signal levels and polarities for various control schemes.

For example, if the gain is to be controlled by a DAC providing a positive-only, ground-referenced output, the gain control low (GNEG) pin should be biased to a fixed offset of 500 mV to set the gain to -10 dB when gain control high (GPOS) is at zero, and to 30 dB when at 1.00 V.

It is a simple matter to include a voltage divider to achieve other scaling factors. When using an 8-bit DAC having an FS output of 2.55 V (10 mV/bit), a divider ratio of 2 (generating 5 mV/bit) results in a gain-setting resolution of 0.2 dB/bit. The use of such offsets is valuable when two AD603s are cascaded, when various options exist for optimizing the signal-to-noise profile, as is shown in the Sequential Mode (Optimal SNR) section,

PROGRAMMING THE FIXED-GAIN AMPLIFIER USING PIN STRAPPING

Access to the feedback network is provided at Pin 5 (FDBK). The user may program the gain of the output amplifier of the AD603 using this pin, as shown in Figure 32, Figure 33, and Figure 34. There are three modes: in the default mode, FDBK is unconnected, providing the range +9 dB/+51 dB; when V_{OUT} and FDBK are shorted, the gain is lowered to -11 dB/+31 dB; and, when an external resistor is placed between V_{OUT} and FDBK, any intermediate gain can be achieved, for example, -1 dB/+41 dB. Figure 35 shows the nominal maximum gain vs. external resistor for this mode.

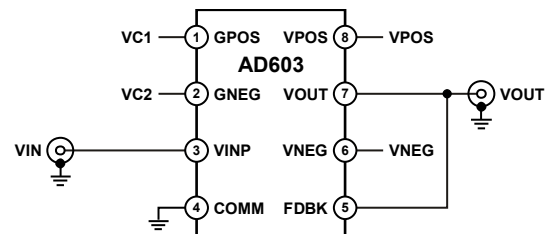

Figure 32. -10 dB to +30 dB; 90 MHz Bandwidth

00538-030

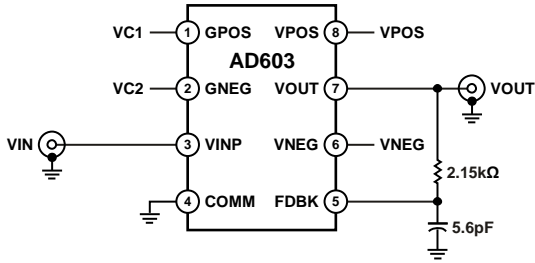

Figure 33. 0 dB to 40 dB; 30 MHz Bandwidth

00539-031

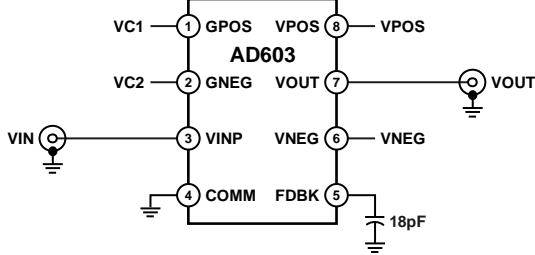

Figure 34. 10 dB to 50 dB; 9 MHz to Set Gain

00539-032

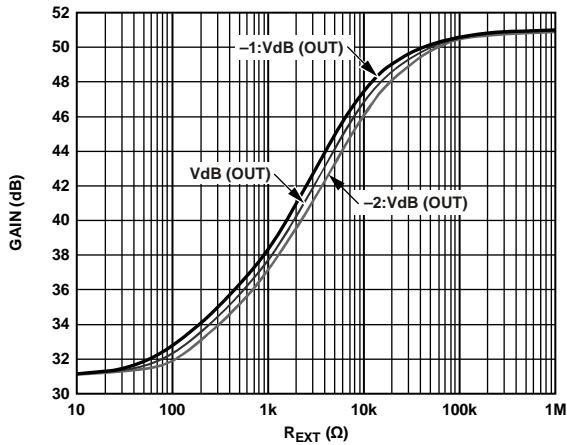

Figure 35. Gain vs. R_{EXT} . Showing Worst-Case Limits Assuming Internal Resistors Have a Maximum Tolerance of 20%

00539-033

Optionally, when a resistor is placed from FDBK to COMM, higher gains can be achieved. This fourth mode is of limited value because of the low bandwidth and the elevated output offsets; it is thus not included in Figure 32, Figure 33, or Figure 34.

The gain of this amplifier in the first two modes is set by the ratio of on-chip laser-trimmed resistors. While the ratio of these resistors is very accurate, the absolute value of these resistors can vary by as much as $\pm 20\%$. Therefore, when an external resistor is connected in parallel with the nominal $6.44 \text{ k}\Omega \pm 20\%$ internal resistor, the overall gain accuracy is somewhat poorer. The worst-case error occurs at about $2 \text{ k}\Omega$ (see Figure 36).

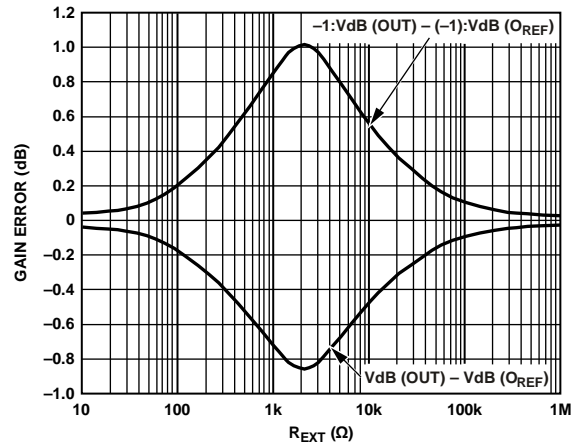

Figure 36. Worst-Case Gain Error, Assuming Internal Resistors Have a Maximum Tolerance of -20% (Top Curve) or $+20\%$ (Bottom Curve)

00539-034

While the gain bandwidth product of the fixed-gain amplifier is about 4 GHz, the actual bandwidth is not exactly related to the maximum gain. This is because there is a slight enhancing of the ac response magnitude on the maximum bandwidth range, due to higher order poles in the open-loop gain function; this mild peaking is not present on the higher gain ranges. Figure 32, Figure 33, and Figure 34 show how an optional capacitor may be added to extend the frequency response in high gain modes.

USING THE AD603 IN CASCADE

Two or more AD603s can be connected in series to achieve higher gain. Invariably, ac coupling must be used to prevent the dc offset voltage at the output of each amplifier from overloading the following amplifier at maximum gain. The required high-pass coupling network is usually just a capacitor, chosen to set the desired corner frequency in conjunction with the well-defined 100 Ω input resistance of the following amplifier.

For two AD603s, the total gain control range becomes 84 dB (2×42.14 dB); the overall -3 dB bandwidth of cascaded stages is somewhat reduced. Depending on the pin strapping, the gain and bandwidth for two cascaded amplifiers can range from -22 dB to $+62$ dB (with a bandwidth of about 70 MHz) to $+22$ dB to $+102$ dB (with a bandwidth of about 6 MHz).

There are several ways of connecting the gain control inputs in cascaded operation. The choice depends on whether it is important to achieve the highest possible instantaneous signal-to-noise ratio (ISNR), or, alternatively, to minimize the ripple in the gain error. The following examples feature the AD603 programmed for maximum bandwidth; the explanations apply to other gain/bandwidth combinations with appropriate changes to the arrangements for setting the maximum gain.

SEQUENTIAL MODE (OPTIMAL SNR)

In the sequential mode of operation, the ISNR is maintained at its highest level for as much of the gain control range as possible.

Figure 37 shows the SNR over a gain range of -22 dB to $+62$ dB, assuming an output of 1 V rms and a 1 MHz bandwidth. Figure 38, Figure 39, and Figure 40 show the general connections to accomplish this. Here, both the positive gain control inputs (GPOS) are driven in parallel by a positive-only, ground-referenced source with a range of 0 V to 2 V, while the negative gain control inputs (GNEG) are biased by stable voltages to provide the needed gain offsets. These voltages may be provided by resistive dividers operating from a common voltage reference.

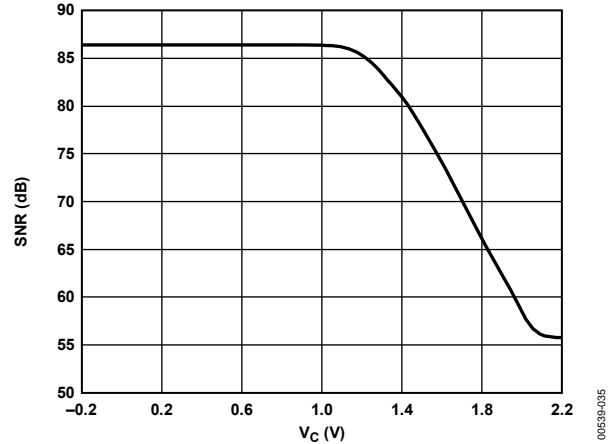

Figure 37. SNR vs. Control Voltage, Sequential Control (1 MHz Bandwidth)

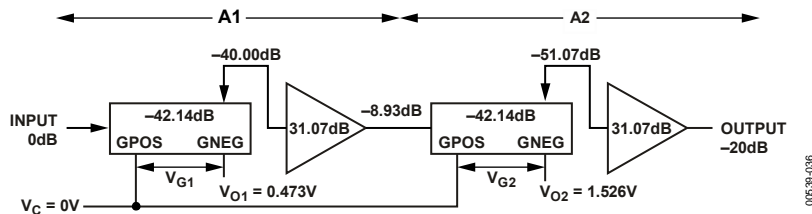

Figure 38. AD603 Gain Control Input Calculations for Sequential Control Operation $V_c = 0$ V

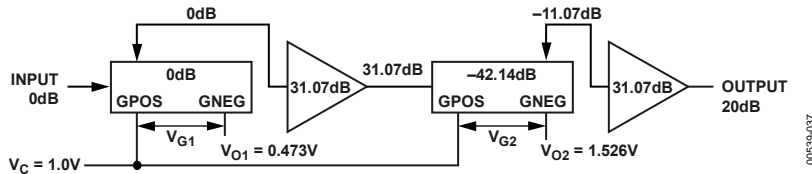

Figure 39. AD603 Gain Control Calculations for Sequential Control Operation $V_c = 1.0$ V

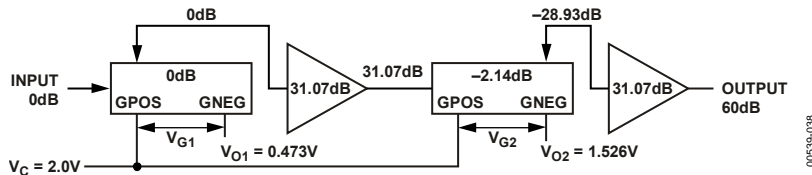

Figure 40. AD603 Gain Control Input Calculations for Sequential Operation $V_c = 2.0$ V

The gains are offset (Figure 41) such that the gain of A2 is increased only after the gain of A1 has reached its maximum value. Note that for a differential input of -600 mV or less, the gain of a single amplifier (A1 or A2) is at its minimum value of -11.07 dB ; for a differential input of 600 mV or more, the gain is at its maximum value of 31.07 dB . Control inputs beyond these limits do not affect the gain and can be tolerated without damage or foldover in the response. This is an important aspect of the gain control response of the AD603. (See the Specifications section for more details on the allowable voltage range.) The gain is now

$$\text{Gain (dB)} = 40 V_G + G_O \tag{3}$$

where:

V_G is the applied control voltage.

G_O is determined by the gain range chosen.

In the explanatory notes that follow, it is assumed that the maximum bandwidth connections are used, for which G_O is -20 dB .

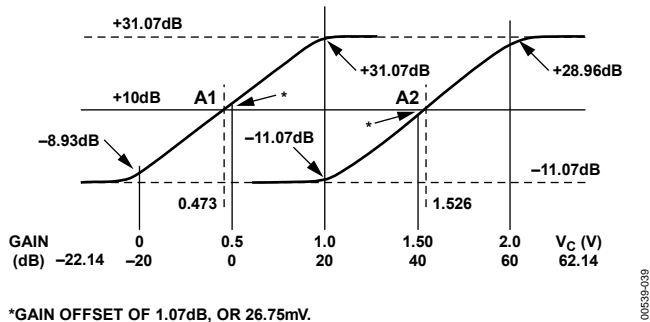

Figure 41. Explanation of Offset Calibration for Sequential Control

With reference to Figure 38, Figure 39, and Figure 40, note that V_{G1} refers to the differential gain control input to A1, and V_{G2} refers to the differential gain control input to A2. When V_G is 0 V , $V_{G1} = -473\text{ mV}$ and thus the gain of A1 is -8.93 dB (recall that the gain of each individual amplifier in the maximum bandwidth mode is -10 dB for $V_G = -500\text{ mV}$ and 10 dB for $V_G = 0\text{ V}$); meanwhile, $V_{G2} = -1.908\text{ V}$ so the gain of A2 is pinned at -11.07 dB . The overall gain is therefore -20 dB (see Figure 38).

When $V_G = 1.00\text{ V}$, $V_{G1} = 1.00\text{ V} - 0.473\text{ V} = 0.526\text{ V}$, which sets the gain of A1 to nearly its maximum value of $+31.07\text{ dB}$, while $V_{G2} = 1.00\text{ V} - 1.526\text{ V} = -0.526\text{ V}$, which sets the gain of A2 to nearly its minimum value of -11.07 dB . Close analysis shows that the degree to which neither AD603 is completely pushed to its maximum nor minimum gain exactly cancels in the overall gain, which is now 20 dB (see Figure 39).

When $V_G = 2.0\text{ V}$, the gain of A1 is pinned at 31.07 dB and that of A2 is near its maximum value of 28.93 dB , resulting in an overall gain of 60 dB (see Figure 40). This mode of operation is further clarified in Figure 42, which is a plot of the separate gains of A1 and A2 and the overall gain vs. the control voltage.

Figure 43 is a plot of the SNR of the cascaded amplifiers vs. the control voltage. Figure 44 is a plot of the gain error of the cascaded stages vs. the control voltages.

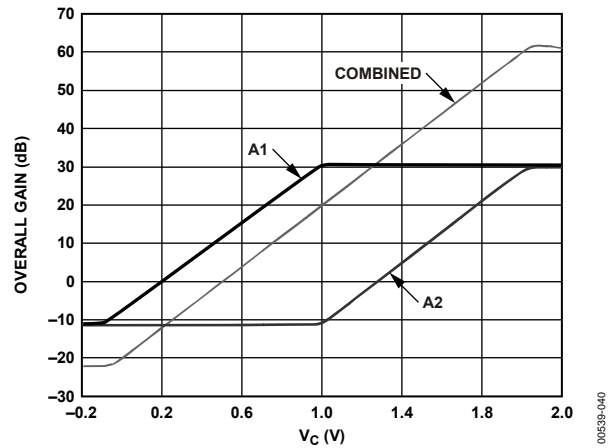

Figure 42. Plot of Separate and Overall Gains in Sequential Control

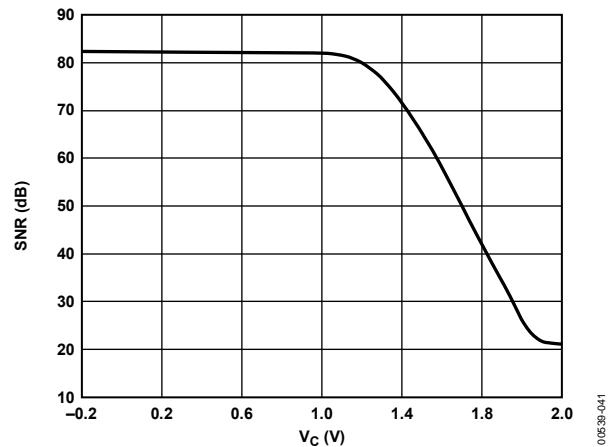

Figure 43. SNR for Cascaded Stages—Sequential Control

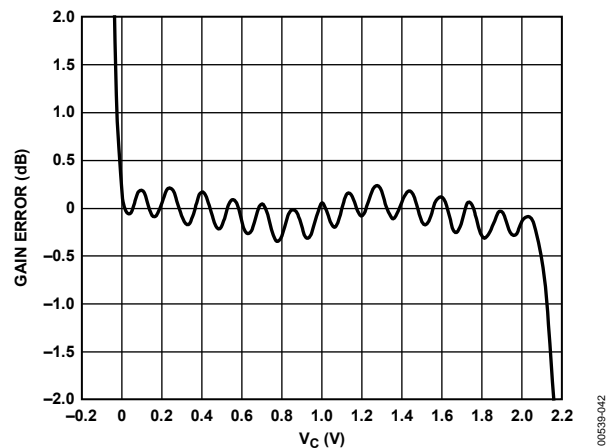

Figure 44. Gain Error for Cascaded Stages—Sequential Control

PARALLEL MODE (SIMPLEST GAIN CONTROL INTERFACE)

In this mode, the gain control of voltage is applied to both inputs in parallel: the GPOS pins of both A1 and A2 are

connected to the control voltage and the GNEW inputs are grounded. The gain scaling is then doubled to 80 dB/V, requiring only a 1.00 V change for an 80 dB change of gain

$$Gain = (\text{dB}) = 80 V_C + G_O \tag{4}$$

where, as before, G_O depends on the range selected; for example, in the maximum bandwidth mode, G_O is 20 dB. Alternatively, the GNEG pins may be connected to an offset voltage of 0.500 V, in which case G_O is -20 dB.

The amplitude of the gain ripple in this case is also doubled, as shown in Figure 45, while the ISNR at the output of A2 now decreases linearly as the gain increases, as shown in Figure 46.

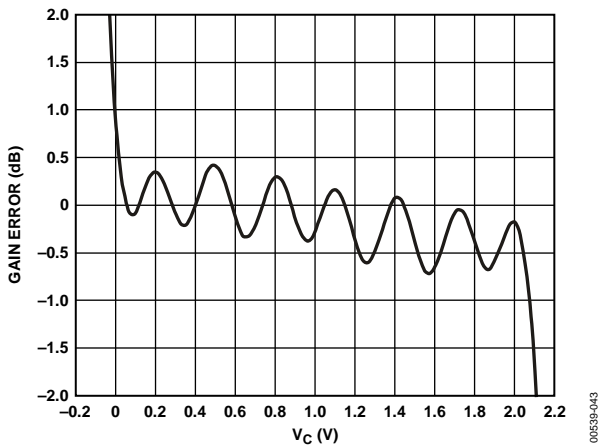

Figure 45. Gain Error for Cascaded Stages—Parallel Control

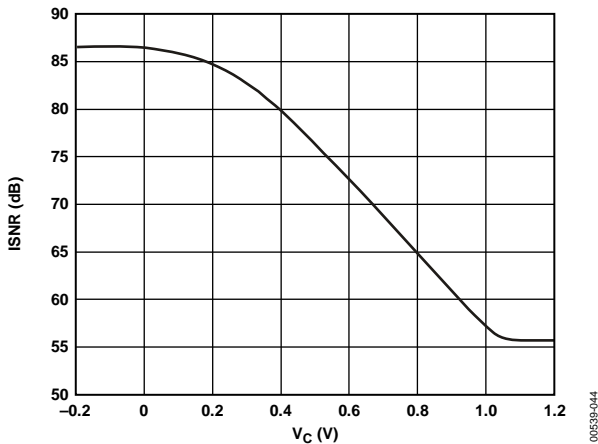

Figure 46. ISNR for Cascaded Stages—Parallel Control

LOW GAIN RIPPLE MODE (MINIMUM GAIN ERROR)

As can be seen in Figure 44 and Figure 45, the error in the gain is periodic, that is, it shows a small ripple. (Note that there is also a variation in the output offset voltage, which is due to the gain interpolation, but this is not exact in amplitude.) By offsetting the gains of A1 and A2 by half the period of the ripple, that is, by 3 dB, the residual gain errors of the two amplifiers can be made to cancel. Figure 47 shows much lower gain ripple when configured in this manner. Figure 48 plots the ISNR as a function of gain; it is very similar to that in the parallel mode.

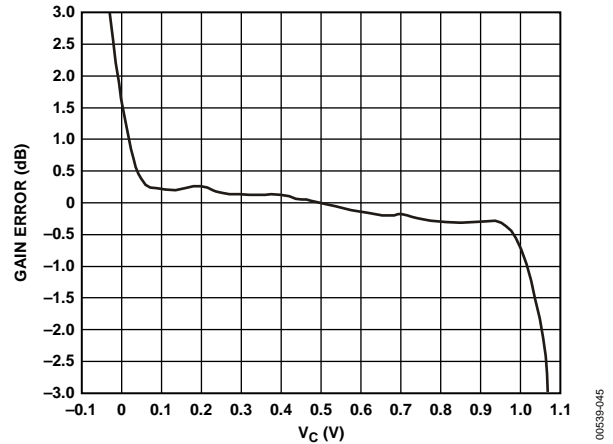

Figure 47. Gain Error for Cascaded Stages—Low Ripple Mode

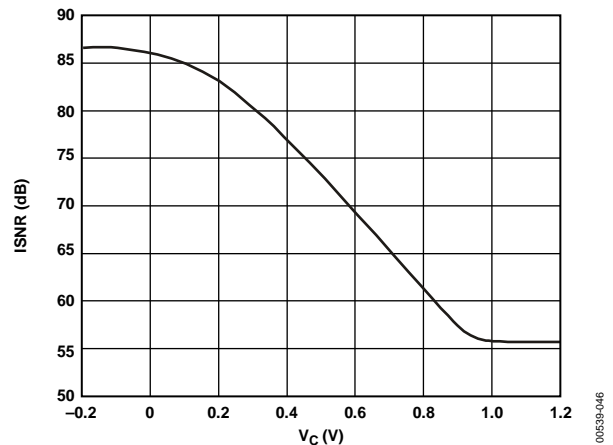

Figure 48. ISNR vs. Control Voltage—Low Ripple Mode

APPLICATIONS INFORMATION

A LOW NOISE AGC AMPLIFIER

Figure 49 shows the ease with which the AD603 can be connected as an AGC amplifier. The circuit illustrates many of the points previously discussed: it uses few parts, has linear-in-dB gain, operates from a single supply, uses two cascaded amplifiers in sequential gain mode for maximum SNR, and an external resistor programs each gain of the amplifier. It also uses a simple temperature-compensated detector.

The circuit operates from a single 10 V supply. Resistors R1, R2, R3, and R4 bias the common pins of A1 and A2 at 5 V. The common pin is a low impedance point and must have a low impedance path to ground, provided here by the 100 μ F tantalum capacitors and the 0.1 μ F ceramic capacitors.

The cascaded amplifiers operate in sequential gain. Here, the offset voltage between Pin 2 (GNEG) of A1 and A2 is 1.05 V (42.14 dB \times 25 mV/dB), provided by a voltage divider consisting of Resistors R5, R6, and R7. Using standard values, the offset is not exact, but it is not critical for this application.

The gain of both A1 and A2 is programmed by Resistors R13 and R14, respectively, to be about 42 dB; therefore, the maximum gain of the circuit is twice that, or 84 dB. The gain control range can be shifted up by as much as 20 dB by appropriate choices of R13 and R14.

The circuit operates as follows:

- A1 and A2 are cascaded.
- Capacitor C1 and the 100 Ω of resistance at the input of A1 form a time constant of 10 μ s.
- C2 blocks the small dc offset voltage at the output of A1 (which might otherwise saturate A2 at its maximum gain) and introduces a high-pass corner at about 16 kHz, eliminating low frequency noise.

A half-wave detector is used, based on Q1 and R8. The current into capacitor, C_{AV} , is the difference between the collector current of Q2 (biased to be 300 μ A at 300 K, 27°C) and the collector current of Q1, which increases with the amplitude of the output signal.

The automatic gain control voltage, V_{AGC} , is the time integral of this error current. For V_{AGC} (and thus the gain) to remain insensitive to short-term amplitude fluctuations in the output signal, the rectified current in Q1 must, on average, exactly balance the current in Q2. If the output of A2 is too small to do this, V_{AGC} increases, causing the gain to increase until Q1 conducts sufficiently.

Consider the case where R8 is zero and the output voltage V_{OUT} is a square wave at, for example, 455 kHz, which is well above the corner frequency of the control loop.

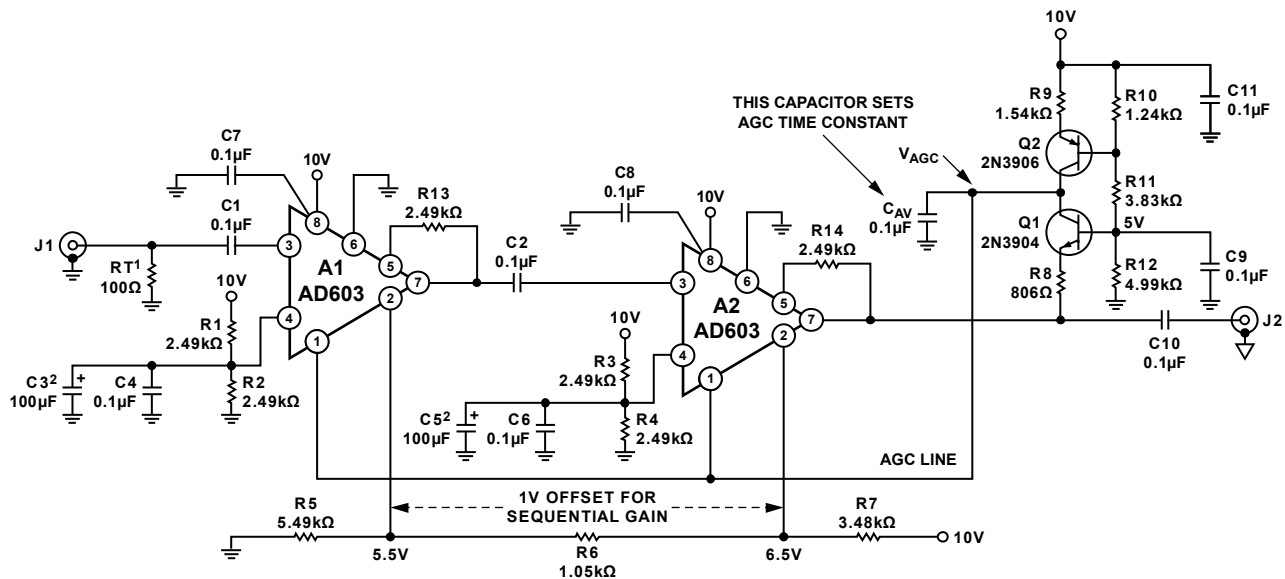

¹RT PROVIDES A 50 Ω INPUT IMPEDANCE.
²C3 AND C5 ARE TANTALUM.

Figure 49. A Low Noise AGC Amplifier

0559-017

During the time V_{OUT} is negative with respect to the base voltage of Q1, Q1 conducts; when V_{OUT} is positive, it is cut off. Because the average collector current of Q1 is forced to be $300\ \mu\text{A}$, and the square wave has a duty cycle of 1:1, Q1's collector current when conducting must be $600\ \mu\text{A}$. With R8 omitted, the peak amplitude of V_{OUT} is forced to be just the V_{BE} of Q1 at $600\ \mu\text{A}$, typically about $700\ \text{mV}$, or $2\ V_{BE}$ peak-to-peak. This voltage, the amplitude at which the output stabilizes, has a strong negative temperature coefficient (TC), typically $-1.7\ \text{mV}/^\circ\text{C}$. Although this may not be troublesome in some applications, the correct value of R8 renders the output stable with temperature.

To understand this, note that the current in Q2 is made to be proportional to absolute temperature (PTAT). For the moment, continue to assume that the signal is a square wave.

When Q1 is conducting, V_{OUT} is now the sum of V_{BE} and a voltage that is PTAT and that can be chosen to have an equal but opposite TC to that of the V_{BE} . This is actually nothing more than an application of the band gap voltage reference principle. When R8 is chosen such that the sum of the voltage across it and the V_{BE} of Q1 is close to the band gap voltage of about $1.2\ \text{V}$, V_{OUT} is stable over a wide range of temperatures, provided, of course, that Q1 and Q2 share the same thermal environment.

Because the average emitter current is $600\ \mu\text{A}$ during each half cycle of the square wave, a resistor of $833\ \Omega$ adds a PTAT voltage of $500\ \text{mV}$ at $300\ \text{K}$, increasing by $1.66\ \text{mV}/^\circ\text{C}$. In practice, the optimum value depends on the type of transistor used and, to a lesser extent, on the waveform for which the temperature stability is to be optimized; for the inexpensive 2N3904/2N3906 pair and sine wave signals, the recommended value is $806\ \Omega$.

This resistor also serves to lower the peak current in Q1 when more typical signals (usually sinusoidal) are involved, and the $1.8\ \text{kHz}$ LP filter it forms with C_{AV} helps to minimize distortion due to ripple in V_{AGC} . Note that the output amplitude under sine wave conditions is higher than for a square wave because the average value of the current for an ideal rectifier is 0.637 times as large, causing the output amplitude to be $1.88 (= 1.2/0.637)\ \text{V}$, or $1.33\ \text{V rms}$. In practice, the somewhat nonideal rectifier results in the sine-wave output being regulated to about $1.4\ \text{V rms}$, or $3.6\ \text{V p-p}$.

The bandwidth of the circuit exceeds $40\ \text{MHz}$. At $10.7\ \text{MHz}$, the AGC threshold is $100\ \mu\text{V}$ ($-67\ \text{dBm}$) and its maximum gain is $83\ \text{dB}$ ($20\ \log 1.4\ \text{V}/100\ \mu\text{V}$). The circuit holds its output at $1.4\ \text{V rms}$ for inputs as low as $-67\ \text{dBm}$ to $+15\ \text{dBm}$ ($82\ \text{dB}$), where the input signal exceeds the maximum input rating of the AD603. For a $30\ \text{dBm}$ input at $10.7\ \text{MHz}$, the second harmonic is $34\ \text{dB}$ down from the fundamental, and the third harmonic is $35\ \text{dB}$ down from the fundamental.

CAUTION

Careful component selection, circuit layout, power supply decoupling, and shielding are needed to minimize the susceptibility of the AD603 to interference from signals such as those from radio and TV stations. In bench evaluation, it is recommended to place all of the components into a shielded box and use feedthrough decoupling networks for the supply voltage. Circuit layout and construction are also critical because stray capacitances and lead inductances can form resonant circuits and are a potential source of circuit peaking, oscillation, or both.

EVALUATION BOARD

The evaluation board of the AD603 enables simple bench-top experimenting to be performed with easy control of the AD603. Built-in flexibility allows convenient configuration to accommodate most operating configurations. Figure 50 is a photograph of the AD603 evaluation board.

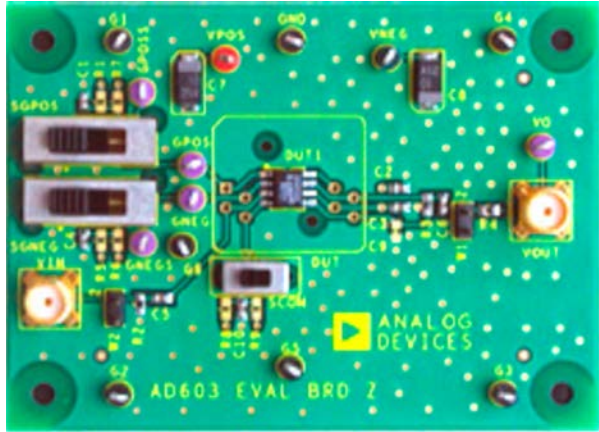

Figure 50. AD603 Evaluation Board

Any dual-polarity power supply capable of providing 20 mA is all that is required, in addition to whatever test equipment the user wishes to perform the intended tests.

Referring to the schematic in Figure 51, the input to the VGA is single-ended, ac-coupled, and terminated in 50 Ω to accommodate most commonly available signal generators.

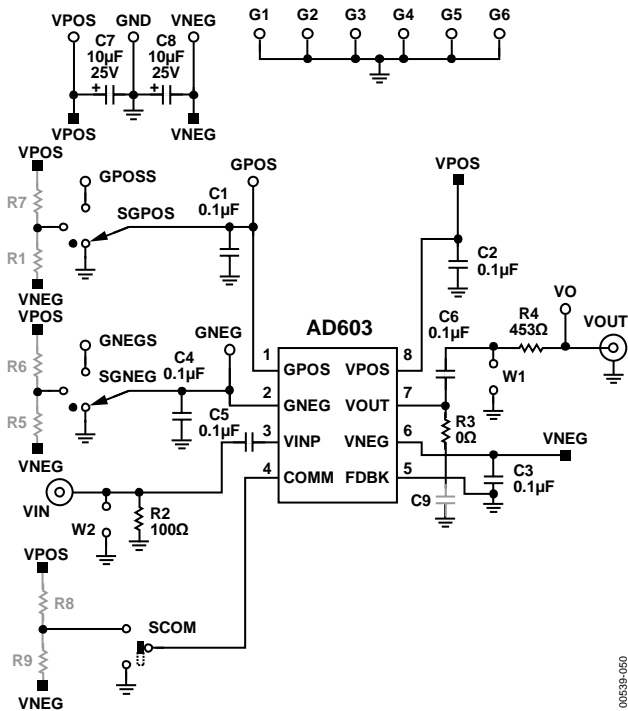

Figure 51. Schematic of the AD603 Evaluation Board

The output is also ac-coupled and includes a 453 Ω series resistor. Set the AD603 gain by connecting a voltage source between the GNEG and GPOS test loops. The two slide switches SGPOS and SGNEG provide three connections for GPOS and the GNEG. Either pin can be ground referenced, or biased with a user selected voltage established by R1 and R5 to R7. A signal generator can be connected to the GPOS or GNEG test loops, or the GNEG can be driven to either polarity within the common-mode limits of -1.2 V to +2.0 V; to invert the gain slope, simply reverse the polarity of the voltage source connected to GPOS and GNEG. For bias current measurements, the third switch option disconnects the bias voltage source and permits connection of a microammeter between the GPOS and GNEG pins to ground.

The AD603 includes built-in gain resistors selectable at the FDBK pin. The board is shipped with the gain at minimum, with a 0 Ω resistor installed in R3. For maximum gain, simply remove R3. Because of the architecture of the AD603, the bandwidth decreases by 10, but the gain range remains at 40 dB. Intermediate gain values may be selected by installing a resistor between the VOUT and FDBK pins.

Figure 52, Figure 53, and Figure 56 show the component and circuit side copper patterns and silkscreen.

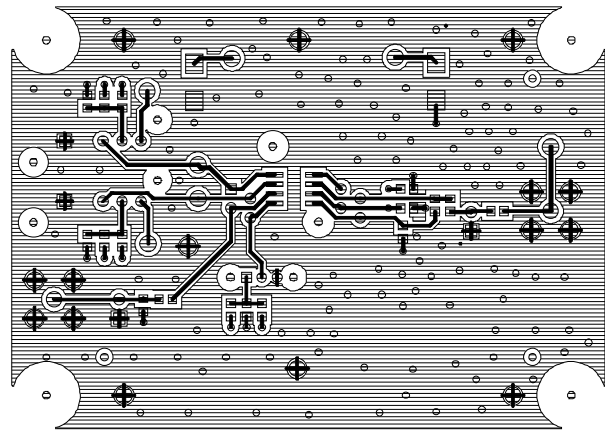

Figure 52. Component Side Copper

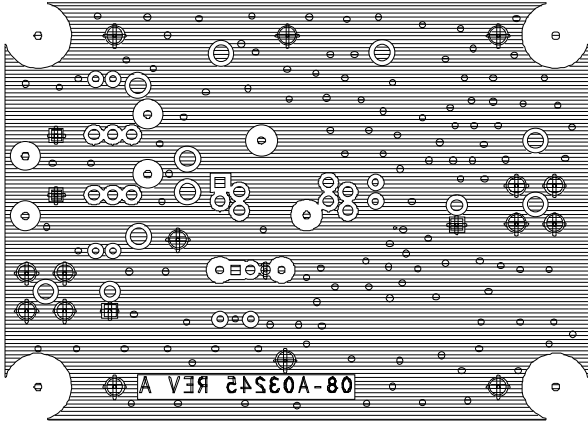

Figure 53. Secondary Side Copper

00539-052

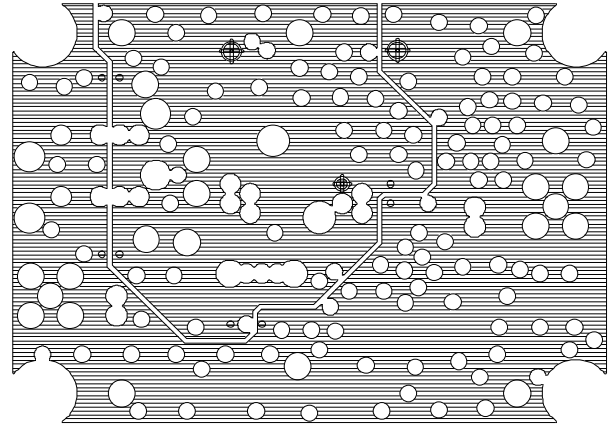

Figure 55. Inner Layer Power Plane

00539-054

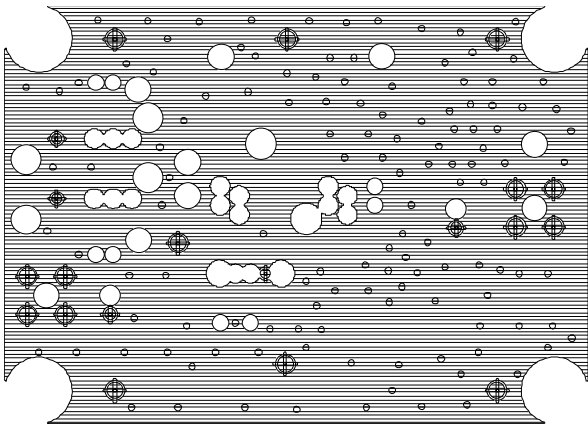

Figure 54. Inner Layer Ground Plane

00539-053

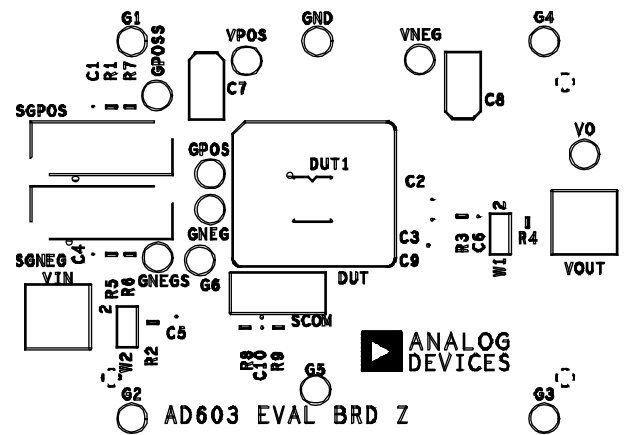
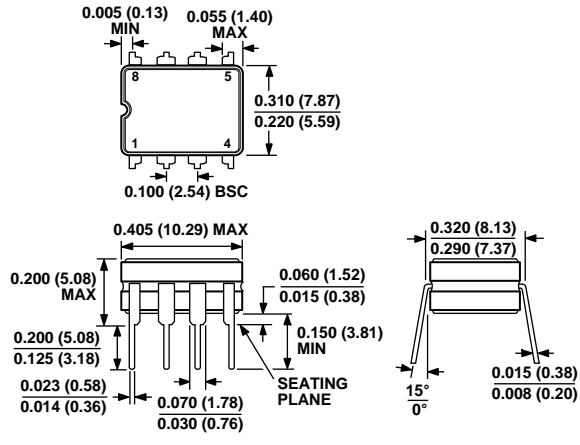

Figure 56. Component Side Silk Screen

00539-055

OUTLINE DIMENSIONS



CONTROLLING DIMENSIONS ARE IN INCHES; MILLIMETER DIMENSIONS (IN PARENTHESES) ARE ROUNDED-OFF INCH EQUIVALENTS FOR REFERENCE ONLY AND ARE NOT APPROPRIATE FOR USE IN DESIGN.

Figure 57. 8-Lead Ceramic Dual In-Line Package [CERDIP] (Q-8)

Dimensions shown in inches and (millimeters)

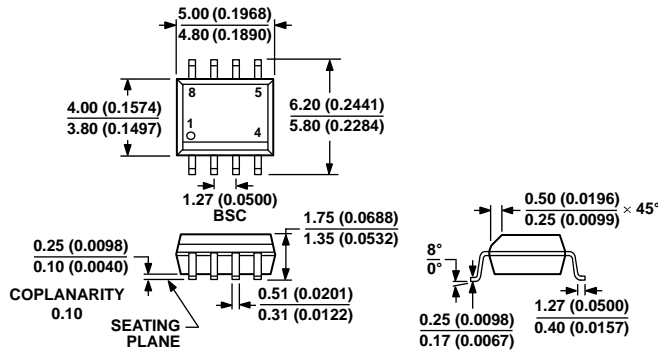

COMPLIANT TO JEDEC STANDARDS MS-012-AA
CONTROLLING DIMENSIONS ARE IN MILLIMETERS; INCH DIMENSIONS (IN PARENTHESES) ARE ROUNDED-OFF MILLIMETER EQUIVALENTS FOR REFERENCE ONLY AND ARE NOT APPROPRIATE FOR USE IN DESIGN.

Figure 58. 8-Lead Standard Small Outline Package [SOIC_N] Narrow Body (R-8)

Dimensions shown in millimeters and (inches)

012407-A



TOP VIEW
(CIRCUIT SIDE)

12-07-2011-A

Figure 59. 9-Pad Bare Die [CHIP]
(C-9-1)
Dimensions Shown in Inches

ORDERING GUIDE

| Model ^{1, 2} | Temperature Range | Package Description | Package Option |
|-----------------------|-------------------|----------------------------------|----------------|
| AD603AR | -40°C to +85°C | 8-Lead SOIC_N | R-8 |
| AD603AR-REEL | -40°C to +85°C | 8-Lead SOIC_N, 13" Tape and Reel | R-8 |
| AD603AR-REEL7 | -40°C to +85°C | 8-Lead SOIC_N, 7" Tape and Reel | R-8 |
| AD603ARZ | -40°C to +85°C | 8-Lead SOIC_N | R-8 |
| AD603ARZ-REEL | -40°C to +85°C | 8-Lead SOIC_N, 13" Tape and Reel | R-8 |
| AD603ARZ-REEL7 | -40°C to +85°C | 8-Lead SOIC_N, 7" Tape and Reel | R-8 |
| AD603AQ | -40°C to +85°C | 8-Lead CERDIP | Q-8 |
| AD603SQ/883B | -55°C to +125°C | 8-Lead CERDIP | Q-8 |
| AD603-EVALZ | | Evaluation Board | |
| AD603ACHIPS | | DIE | C-9-1 |

¹ Z = RoHS Compliant Part.

² For AD603SQ/883B, refer to AD603 Military data sheet. Also available as 5962-9457203MPA.

NOTES



Стандарт Электрон Связь

Мы молодая и активно развивающаяся компания в области поставок электронных компонентов. Мы поставляем электронные компоненты отечественного и импортного производства напрямую от производителей и с крупнейших складов мира.

Благодаря сотрудничеству с мировыми поставщиками мы осуществляем комплексные и плановые поставки широчайшего спектра электронных компонентов.

Собственная эффективная логистика и склад в обеспечивает надежную поставку продукции в точно указанные сроки по всей России.

Мы осуществляем техническую поддержку нашим клиентам и предпродажную проверку качества продукции. На все поставляемые продукты мы предоставляем гарантию .

Осуществляем поставки продукции под контролем ВП МО РФ на предприятия военно-промышленного комплекса России , а также работаем в рамках 275 ФЗ с открытием отдельных счетов в уполномоченном банке. Система менеджмента качества компании соответствует требованиям ГОСТ ISO 9001.

Минимальные сроки поставки, гибкие цены, неограниченный ассортимент и индивидуальный подход к клиентам являются основой для выстраивания долгосрочного и эффективного сотрудничества с предприятиями радиоэлектронной промышленности, предприятиями ВПК и научно-исследовательскими институтами России.

С нами вы становитесь еще успешнее!

Наши контакты:

Телефон: +7 812 627 14 35

Электронная почта: sales@st-electron.ru

Адрес: 198099, Санкт-Петербург,
Промышленная ул, дом № 19, литера Н,
помещение 100-Н Офис 331