

Half-Bridge Driver

Features

- Floating channel designed for bootstrap operation
- Fully operational to +600V
- Tolerant to negative transient voltage
- dV/dt immune
- Gate drive supply range from 10 to 20V
- Undervoltage lockout
- 3.3V, 5V and 15V logic compatible
- Cross-conduction prevention logic
- Matched propagation delay for both channels
- Internal set deadtime
- High side output in phase with HIN input
- Low side output out of phase with LIN input

Product Summary

| | |
|---------------------------|---------------|
| V_{OFFSET} (max) | 600V |
| $I_{\text{O+/-}}$ | 130mA / 270mA |
| V_{OUT} | 10V – 20V |
| ton/off (typ.) | 680 & 150 ns |
| Deadtime (typ.) | 520 ns |

Description

The IR2103(S) are high voltage, high speed power MOSFET and IGBT drivers with dependent high and low side referenced output channels. Proprietary HVIC and latch immune CMOS technologies enable ruggedized monolithic construction. The logic input is compatible with standard CMOS or LSTTL output, down to 3.3V logic. The output drivers feature a high pulse current buffer stage designed for minimum driver cross-conduction. The floating channel can be used to drive an N-channel power MOSFET or IGBT in the high side configuration which operates up to 600 volts.

Package Options

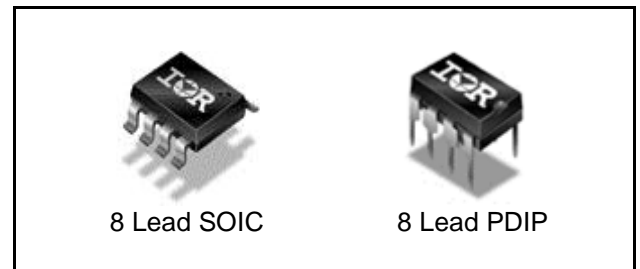

Ordering Information

| Base Part Number | Package Type | Standard Pack | | Orderable Part Number |
|------------------|--------------|---------------|----------|-----------------------|
| | | Form | Quantity | |
| IR2103SPBF | SO8N | Tube | 95 | IR2103SPBF |
| IR2103SPBF | SO8N | Tape and Reel | 2500 | IR2103STRPBF |
| IR2103PBF | PDIP8 | Tube | 50 | IR2103PBF |

| Table of Contents | Page |
|--|-------------|
| Description | 1 |
| Ordering Information | 1 |
| Typical Connection Diagram | 3 |
| Absolute Maximum Ratings | 4 |
| Recommended Operating Conditions | 4 |
| Dynamic Electrical Characteristics | 5 |
| Static Electrical Characteristics | 5 |
| Functional Block Diagrams | 6 |
| Lead Definitions | 7 |
| Lead Assignments | 7 |
| Application Information and Additional Details | 8 |
| Package Details: PDIP8, SO8N | 15 |
| Tape and Reel Details: SO8N | 16 |
| Part Marking Information | 17 |
| Qualification Information | 18 |

Typical Connection Diagram

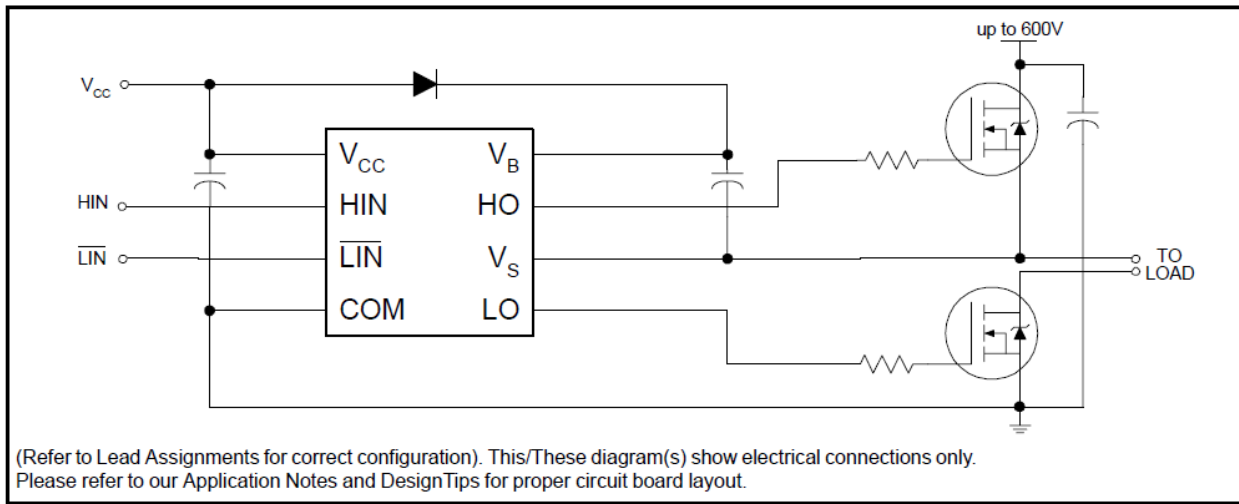

Absolute Maximum Ratings

Absolute maximum ratings indicate sustained limits beyond which damage to the device may occur. All voltage parameters are absolute voltages referenced to COM. The thermal resistance and power dissipation ratings are measured under board mounted and still air conditions.

| Symbol | Definition | Min. | Max. | Units | |
|------------|---|-------------|----------------|------------------|--------------------|
| V_B | High side floating absolute voltage | -0.3 | 625 | V | |
| V_S | High side floating supply offset voltage | $V_B - 25$ | $V_B + 0.3$ | | |
| V_{HO} | High side floating output voltage | $V_S - 0.3$ | $V_B + 0.3$ | | |
| V_{CC} | Low side and logic fixed supply voltage | -0.3 | 25 | | |
| V_{LO} | Low side output voltage | -0.3 | $V_{CC} + 0.3$ | | |
| V_{IN} | Logic input voltage (HIN & LIN) | -0.3 | $V_{CC} + 0.3$ | | |
| dV_S/dt | Allowable offset supply voltage transient | — | 50 | V/ns | |
| P_D | Package power dissipation @ $T_A \leq +25^\circ\text{C}$ | 8 lead PDIP | — | 1 | W |
| | | 8 lead SOIC | — | 0.625 | |
| R_{thJA} | Thermal resistance, junction to ambient | 8 lead PDIP | — | 125 | $^\circ\text{C/W}$ |
| | | 8 lead SOIC | — | 200 | |
| T_J | Junction temperature | — | 150 | $^\circ\text{C}$ | |
| T_S | Storage temperature | -55 | 150 | | |
| T_L | Lead temperature (soldering, 10 seconds) | — | 300 | | |

Recommended Operating Conditions

The input/output logic timing diagram is shown in figure 1. For proper operation the device should be used within the recommended conditions. The V_S offset rating is tested with all supplies biased at 15V differential.

| Symbol | Definition | Min. | Max. | Units |
|----------|--|------------|------------|------------------|
| V_B | High side floating absolute voltage | $V_S + 10$ | $V_S + 20$ | V |
| V_S | High side floating supply offset voltage | † | 600 | |
| V_{HO} | High side floating output voltage | V_S | V_B | |
| V_{CC} | Low side and logic fixed supply voltage | 10 | 20 | |
| V_{LO} | Low side output voltage | 0 | V_{CC} | |
| V_{IN} | Logic input voltage (HIN & LIN) | 0 | V_{CC} | |
| T_A | Ambient temperature | -40 | 125 | $^\circ\text{C}$ |

† Logic operational for V_S of -5 to +600V. Logic state held for V_S of -5V to $-V_{BS}$. (Please refer to the Design Tip DT97-3 for more details).

Dynamic Electrical Characteristics

V_{BIAS} (V_{CC} , V_{BS}) = 15V, C_L = 1000 pF and T_A = 25°C unless otherwise specified.

| Symbol | Definition | Min. | Typ. | Max. | Units | Test Conditions |
|-----------|---|------|------|------|-------|-----------------|
| t_{on} | Turn-on propagation delay | — | 680 | 820 | ns | $V_S = 0V$ |
| t_{off} | Turn-off propagation delay | — | 150 | 220 | | $V_S = 600V$ |
| t_r | Turn-on rise time | — | 100 | 170 | | |
| t_f | Turn-off fall time | — | 50 | 60 | | |
| DT | Deadtime, LS turn-off to HS turn-on & HS turn-on to LS turn-off | 400 | 520 | 650 | | |
| MT | Delay matching, HS & LS turn on/off | — | — | 60 | | |

Static Electrical Characteristics

V_{BIAS} (V_{CC} , V_{BS}) = 15V and T_A = 25°C unless otherwise specified. The V_{IN} , V_{TH} , and I_{IN} parameters are referenced to COM. The V_O and I_O parameters are referenced to COM and are applicable to the respective output leads: HO or LO.

| Symbol | Definition | Min. | Typ. | Max. | Units | Test Conditions |
|-------------|---|------|------|------|---------|---|
| V_{IH} | Logic "1" (HIN) & Logic "0" (LIN) input voltage | 3 | — | — | V | $V_{CC} = 10V$ to 20V |
| V_{IL} | Logic "0" (HIN) & Logic "1" (LIN) input voltage | — | — | 0.8 | | $V_{CC} = 10V$ to 20V |
| V_{OH} | High level output voltage $V_{BIAS} - V_O$ | — | — | 100 | mV | $I_O = 0A$ |
| V_{OL} | Low level output voltage, V_O | — | — | 100 | | $I_O = 0A$ |
| I_{LK} | Offset supply leakage current | — | — | 50 | μA | $V_B = V_S = 600V$ |
| I_{QBS} | Quiescent V_{BS} supply current | — | 30 | 55 | | $V_{IN} = 0V$ or 5V |
| I_{QCC} | Quiescent V_{CC} supply current | — | 150 | 270 | | $V_{IN} = 0V$ or 5V |
| I_{IN+} | Logic "1" input bias current | — | 3 | 10 | | $H_{IN} = 5V$, $L_{IN} = 0V$ |
| I_{IN-} | Logic "0" input bias current | — | — | 1 | | $H_{IN} = 0V$, $L_{IN} = 5V$ |
| V_{CCUV+} | V_{CC} supply undervoltage positive going threshold | 8 | 8.9 | 9.8 | V | |
| V_{CCUV-} | V_{CC} supply undervoltage negative going threshold | 7.4 | 8.2 | 9 | | |
| I_{O+} | Output high short circuit pulsed current | 130 | 210 | — | mA | $V_O = 0V$, $V_{IN} = V_{IH}$ $PW \leq 10 \mu s$ |
| I_{O-} | Output low short circuit pulsed current | 270 | 360 | — | | $V_O = 15V$, $V_{IN} = V_{IL}$ $PW \leq 10 \mu s$ |

Functional Block Diagram

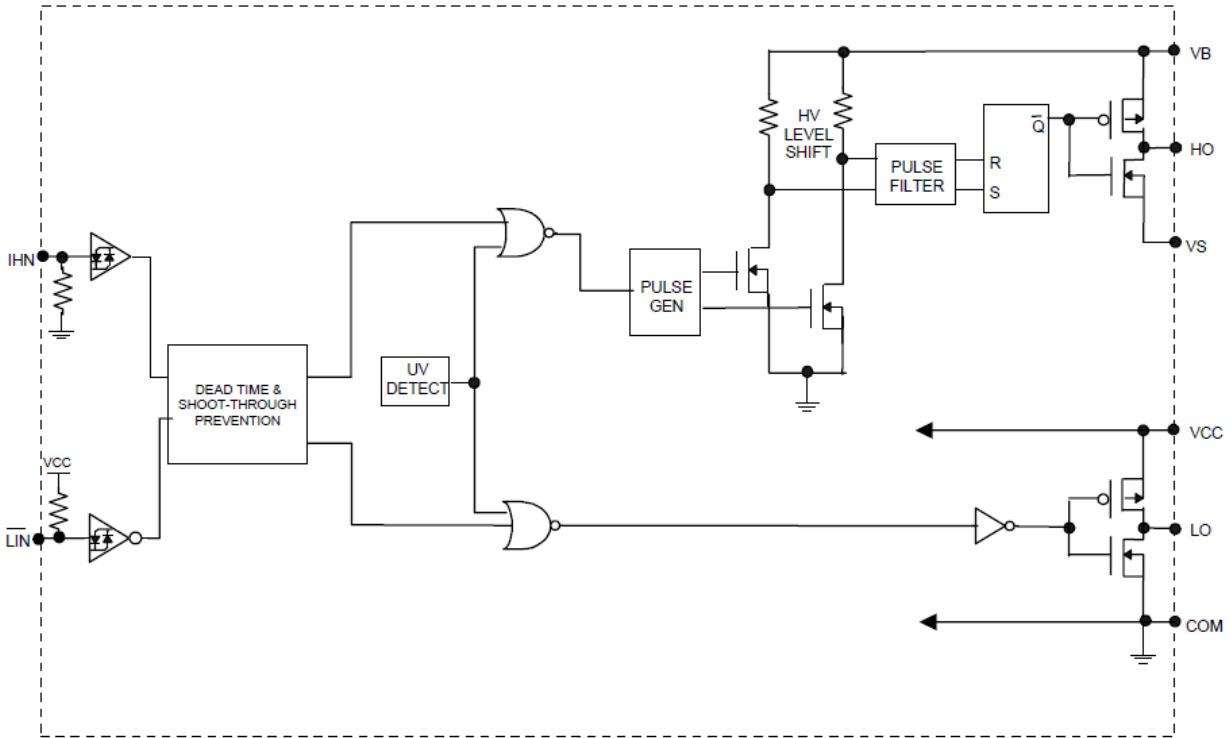

Lead Definitions

| Symbol | Description |
|-----------------|--|
| HIN | Logic input for high side gate driver output (HO), in phase |
| LIN | Logic input for low side gate driver output (LO), out of phase |
| V _B | High side floating supply |
| HO | High side gate drive output |
| V _S | High side floating supply return |
| V _{CC} | Low side and logic fixed supply |
| LO | Low side gate drive output |
| COM | Low side return |

Lead Assignments

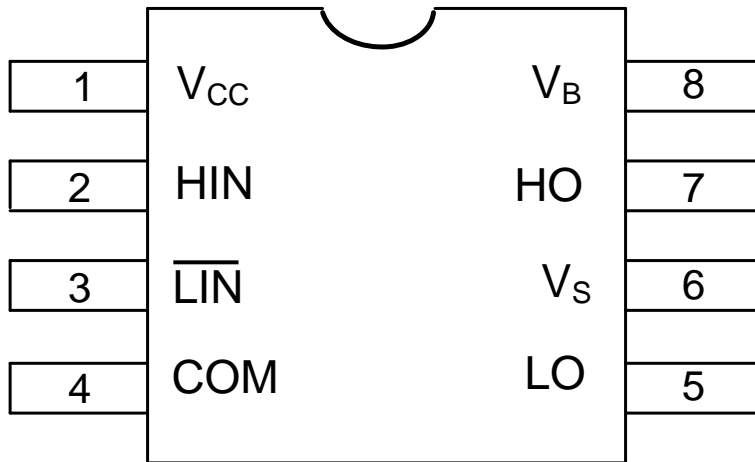

Application Information and Additional Details

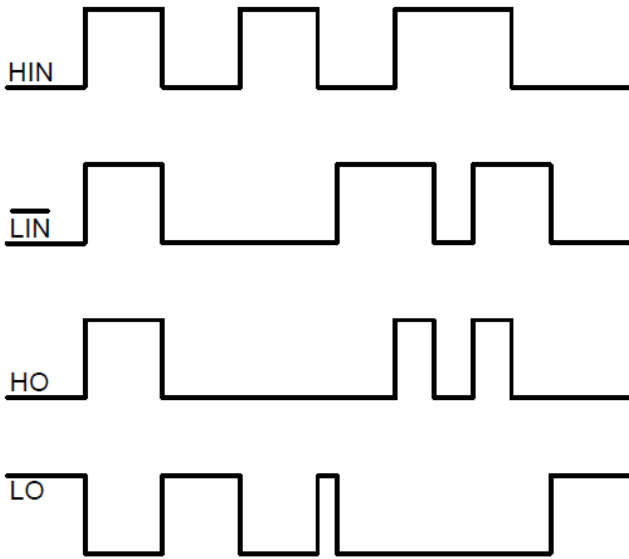

Figure 1. Input/Output Timing Diagram

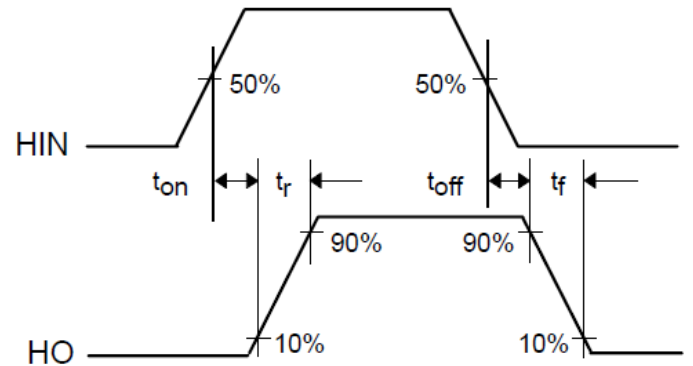
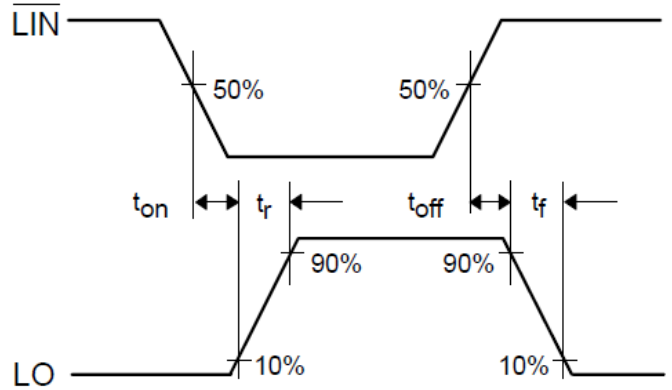

Figure 2. Switching Time Waveform Definitions

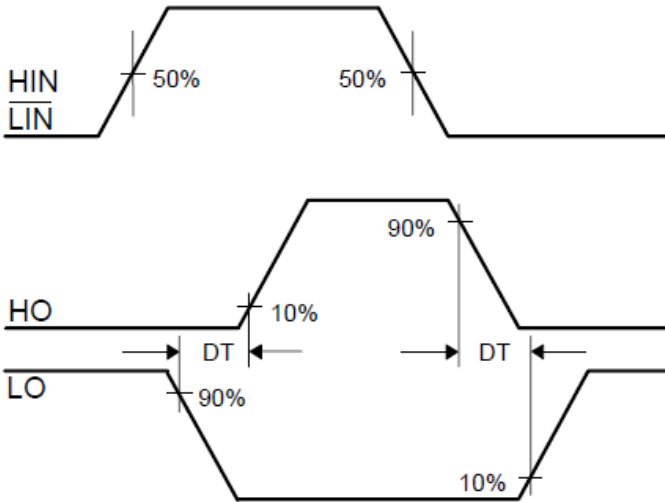

Figure 3. Deadtime Waveform Definitions

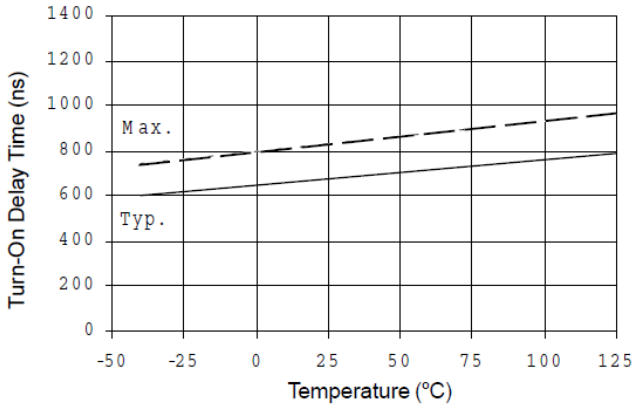

Figure 4A. Turn-On Time vs. Temperature

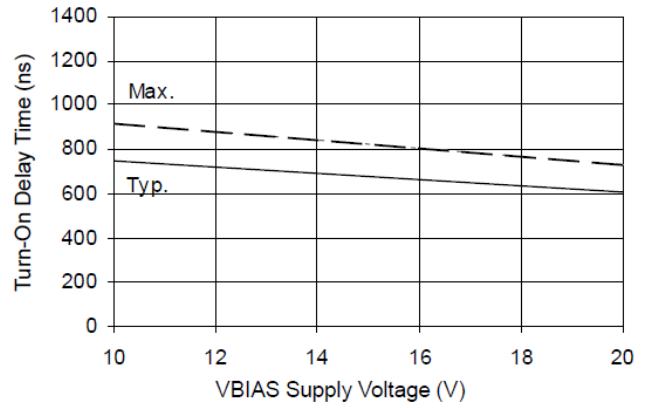

Figure 4B. Turn-On Time vs. Supply Voltage

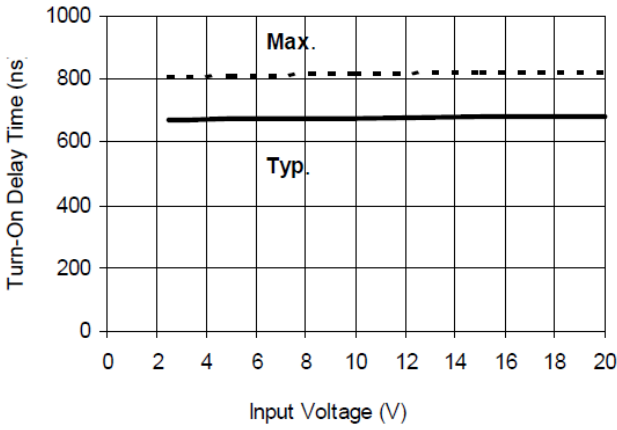

Figure 4C. Turn-On Time vs. Input Voltage

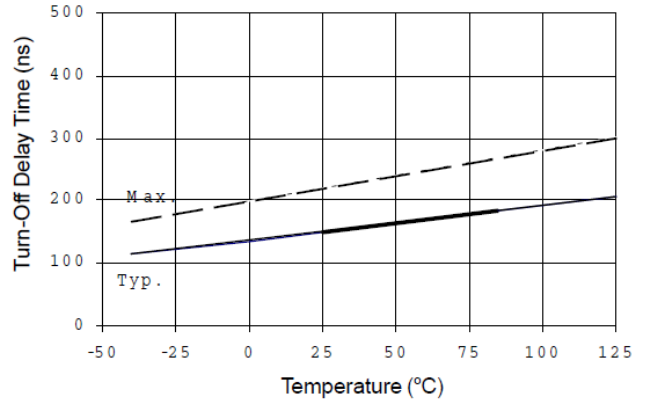

Figure 5A. Turn-Off Time vs. Temperature

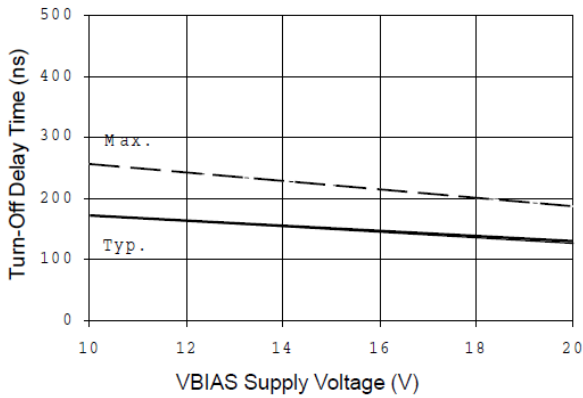

Figure 5B. Turn-Off Time vs. Supply Voltage

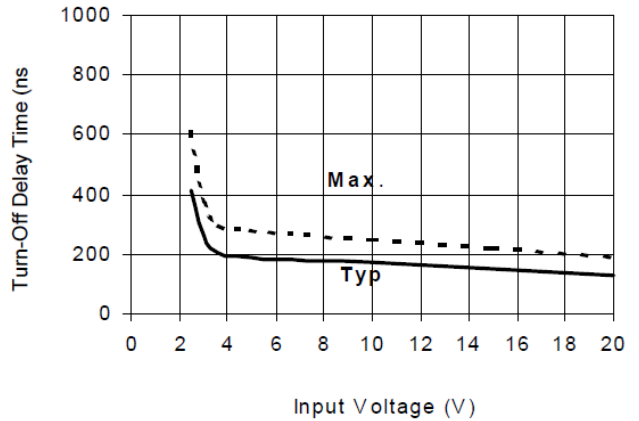

Figure 5C. Turn-Off Time vs. Input Voltage

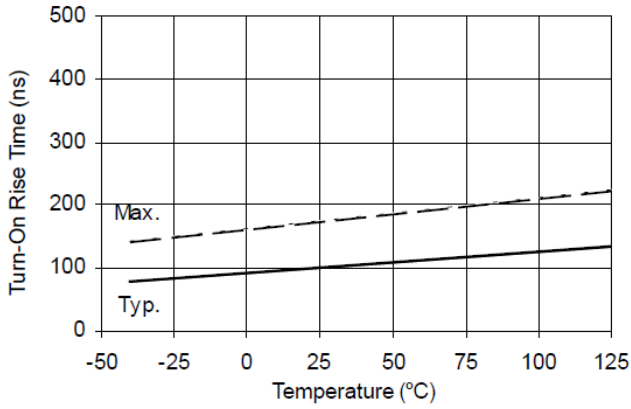

Figure 6A. Turn-On Rise Time vs. Temperature

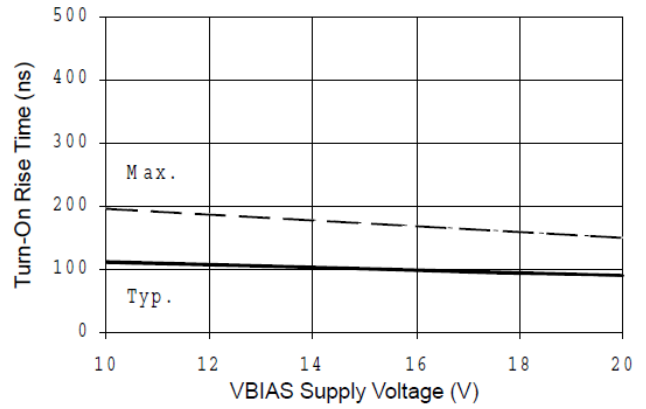

Figure 6B. Turn-On Rise Time vs. Voltage

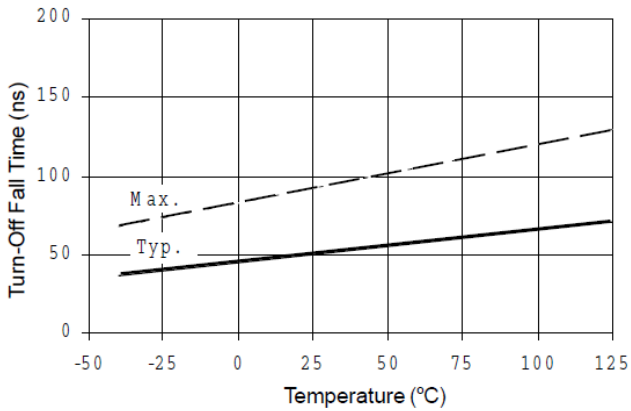

Figure 7A. Turn Off Fall Time vs. Temperature

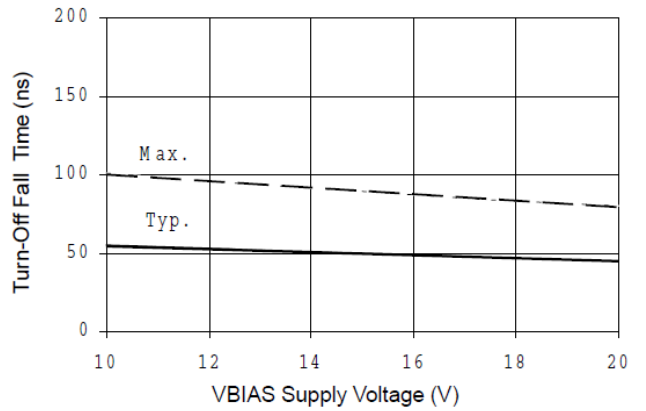

Figure 7B. Turn Off Fall Time vs. Voltage

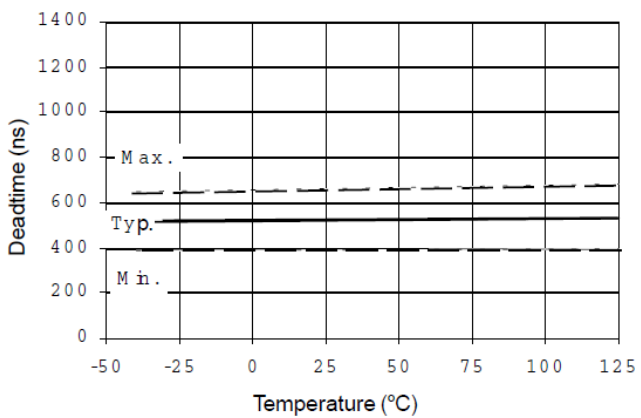

Figure 8A. Deadtime vs. Temperature

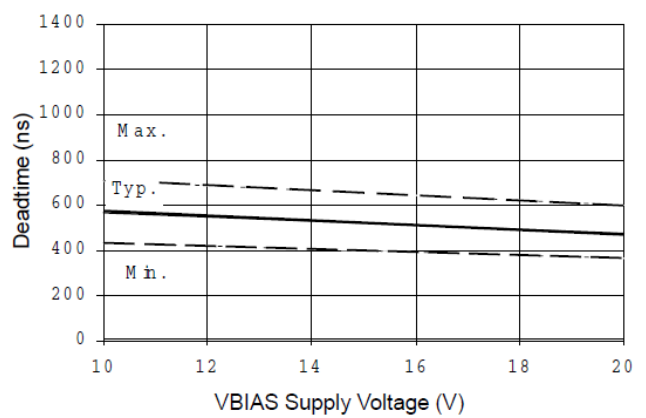

Figure 8B. Deadtime vs. Voltage

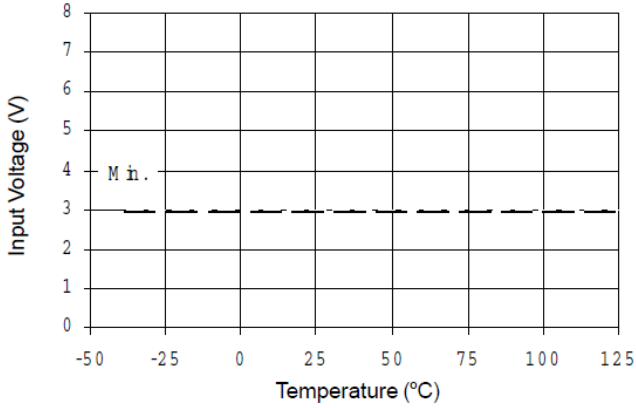

Figure 9A. Logic "1" (HIN) & Logic "0" (LIN) Input Voltage vs. Temperature

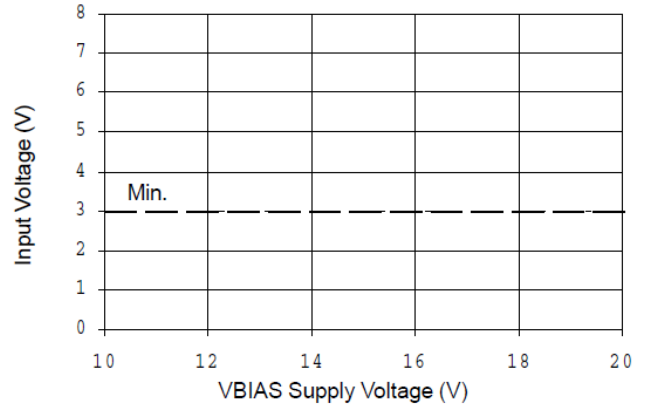

Figure 9B. Logic "1" (HIN) & Logic "0" (LIN) Input Voltage vs. Voltage

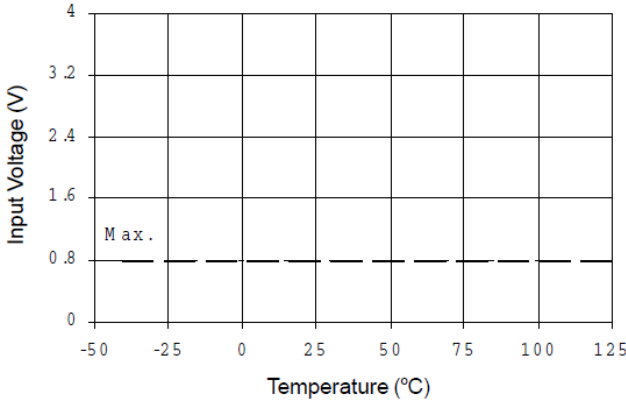

Figure 10A. Logic "0" (HIN) & Logic "1" (LIN) Input Voltage vs. Temperature

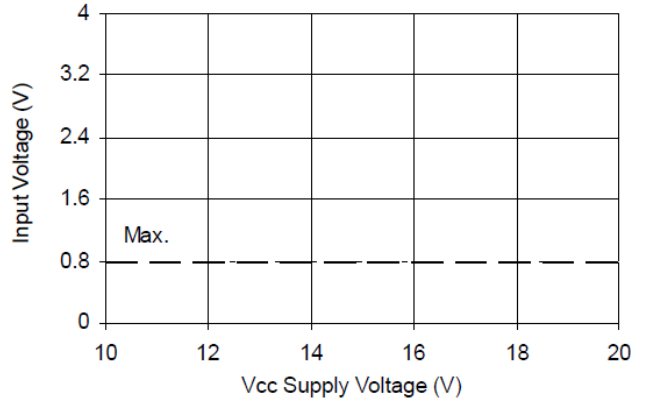

Figure 10B. Logic "0" (HIN) & Logic "1" (LIN) Input Voltage vs. Voltage

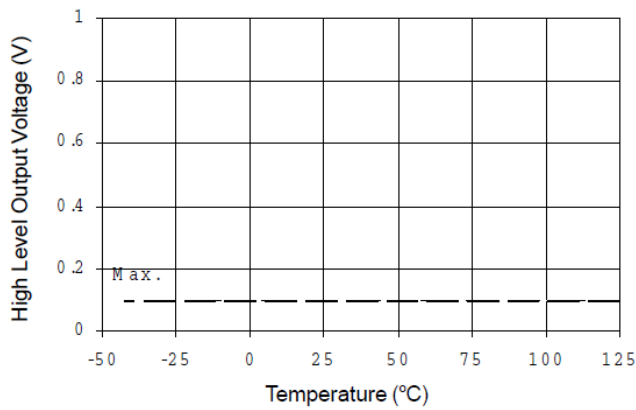

Figure 11A. High Level Output vs. Temperature

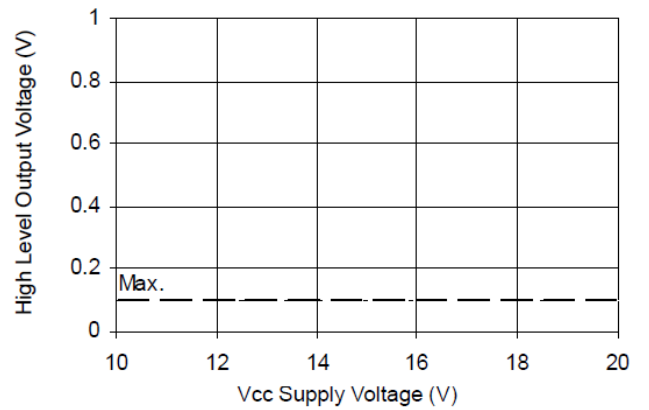

Figure 11B. High Level Output vs. Voltage

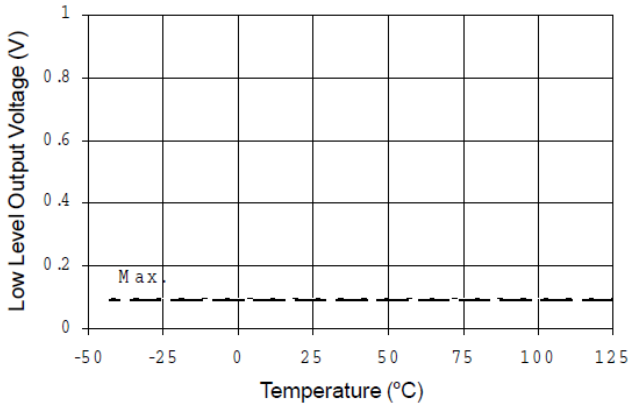

Figure 12A. Low Level Output vs. Temperature

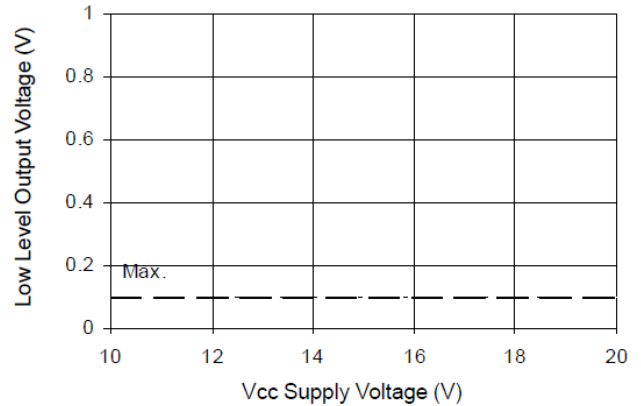

Figure 12B. Low Level Output vs. Voltage

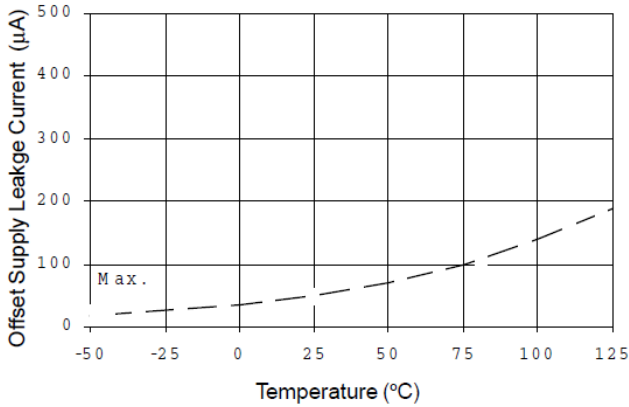

Figure 13A. Offset Supply Current vs. Temperature

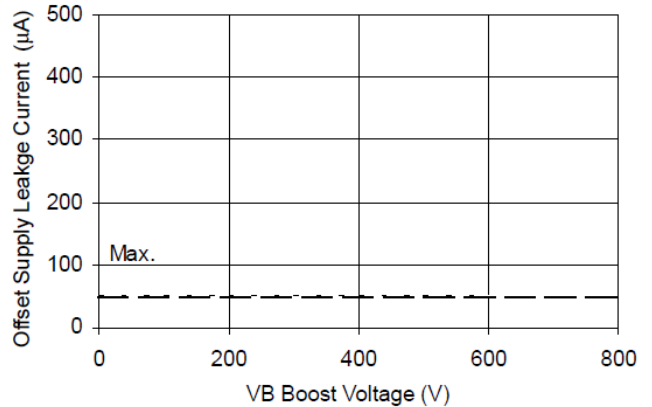

Figure 13B. Offset Supply Current vs. Voltage

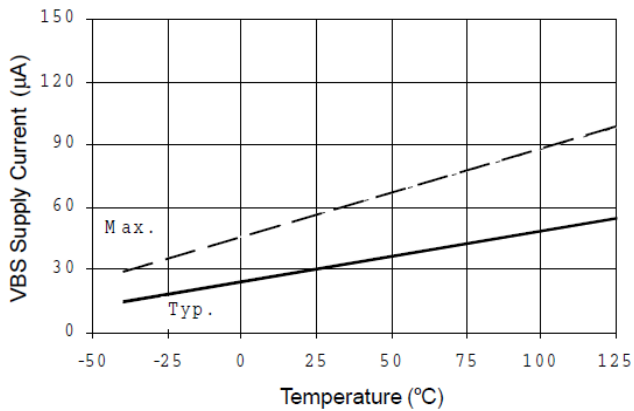

Figure 14A. V_{BS} Supply Current vs. Temperature

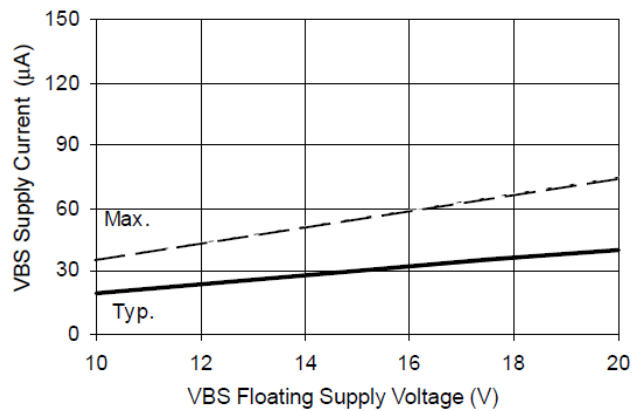

Figure 14B. V_{BS} Supply Current vs. Voltage

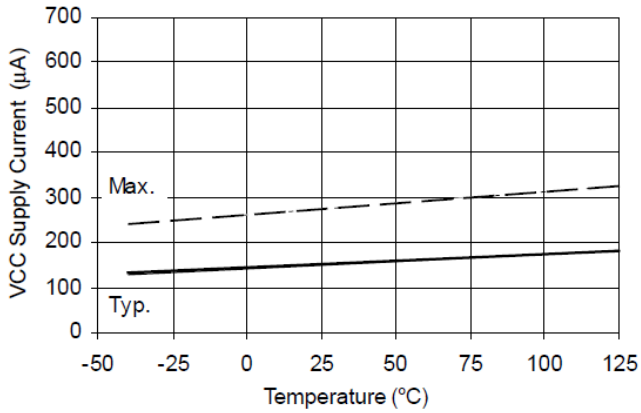

Figure 15A. V_{CC} Supply Current vs. Temperature

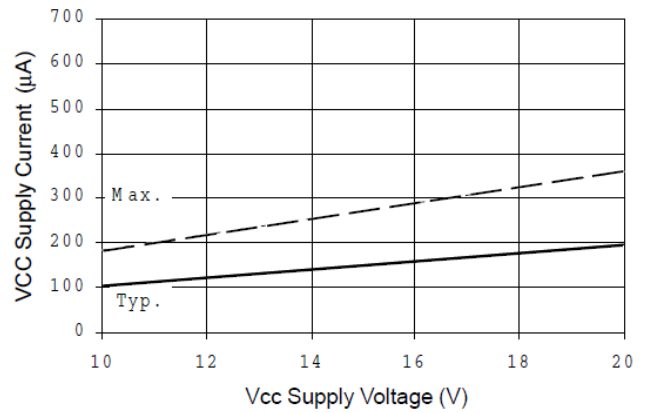

Figure 15B. V_{CC} Supply Current vs. Voltage

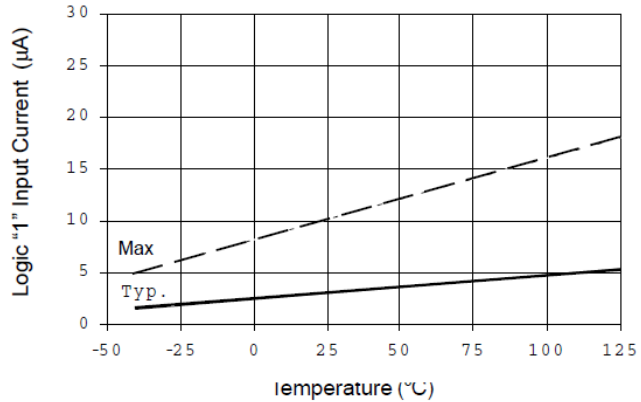

Figure 16A. Logic "1" Input Current vs. Temperature

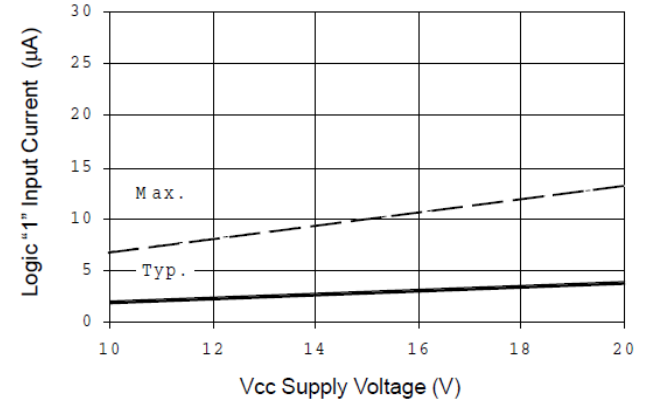

Figure 16B. Logic "1" Input Current vs. Voltage

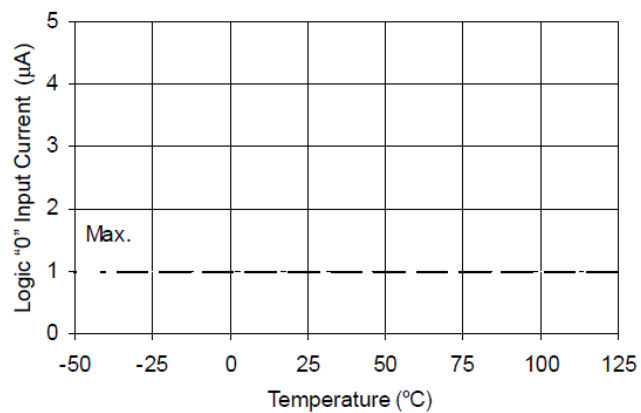

Figure 17A. Logic "0" Input Current vs. Temperature

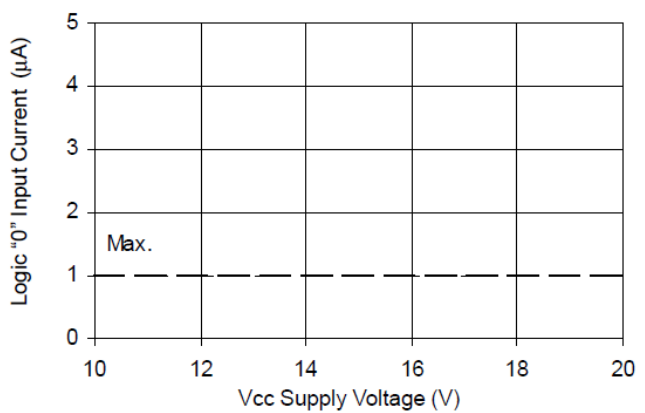

Figure 17B. Logic "0" Input Current vs. Voltage

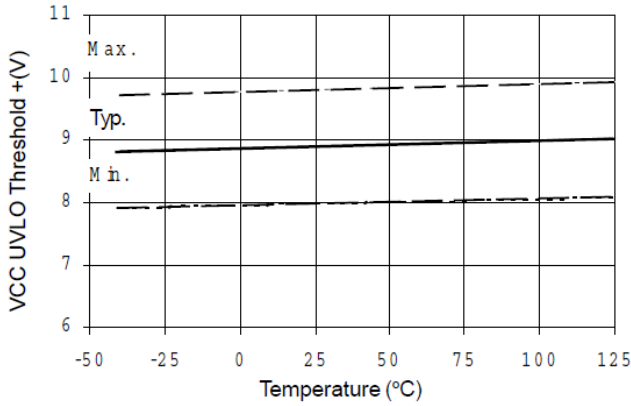

Figure 18A. V_{CC} Undervoltage Threshold (+) vs. Temperature

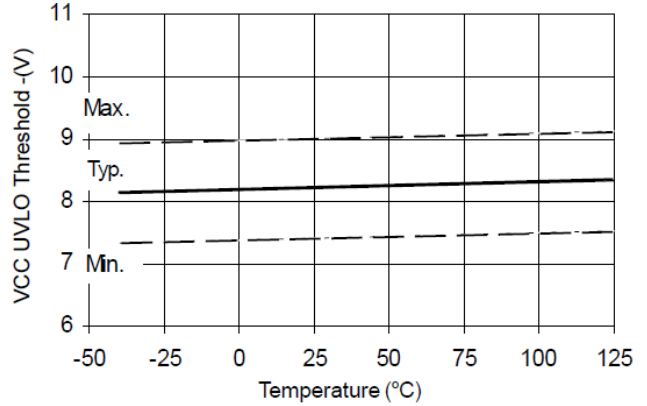

Figure 18B. V_{CC} Undervoltage Threshold (-) vs. Temperature

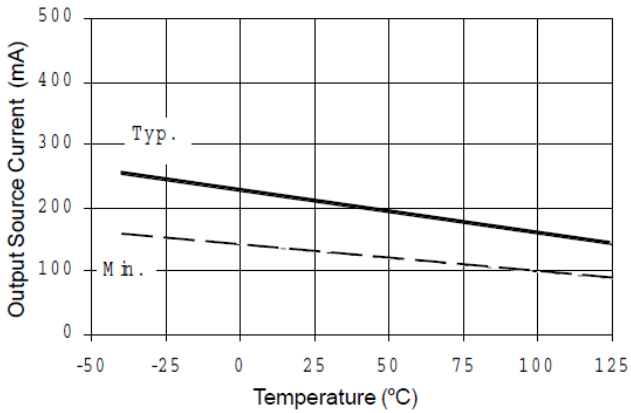

Figure 19A. Output Source Current vs. Temperature

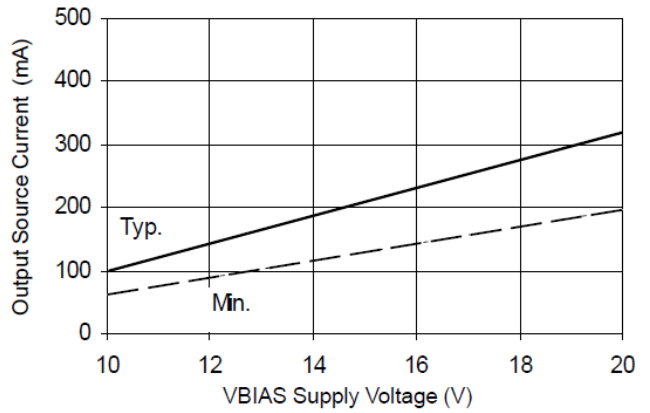

Figure 19B. Output Source Current vs. Voltage

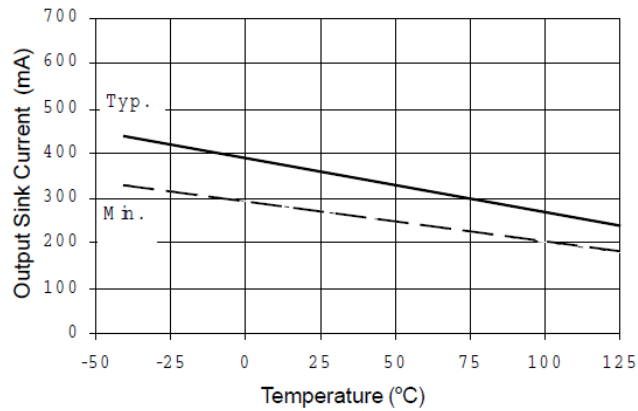

Figure 20A. Output Sink Current vs. Temperature

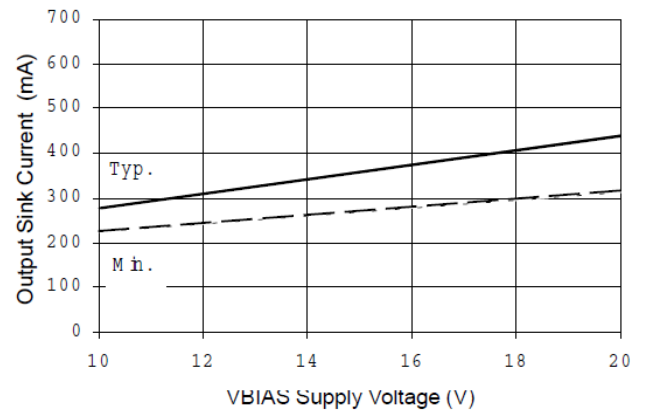
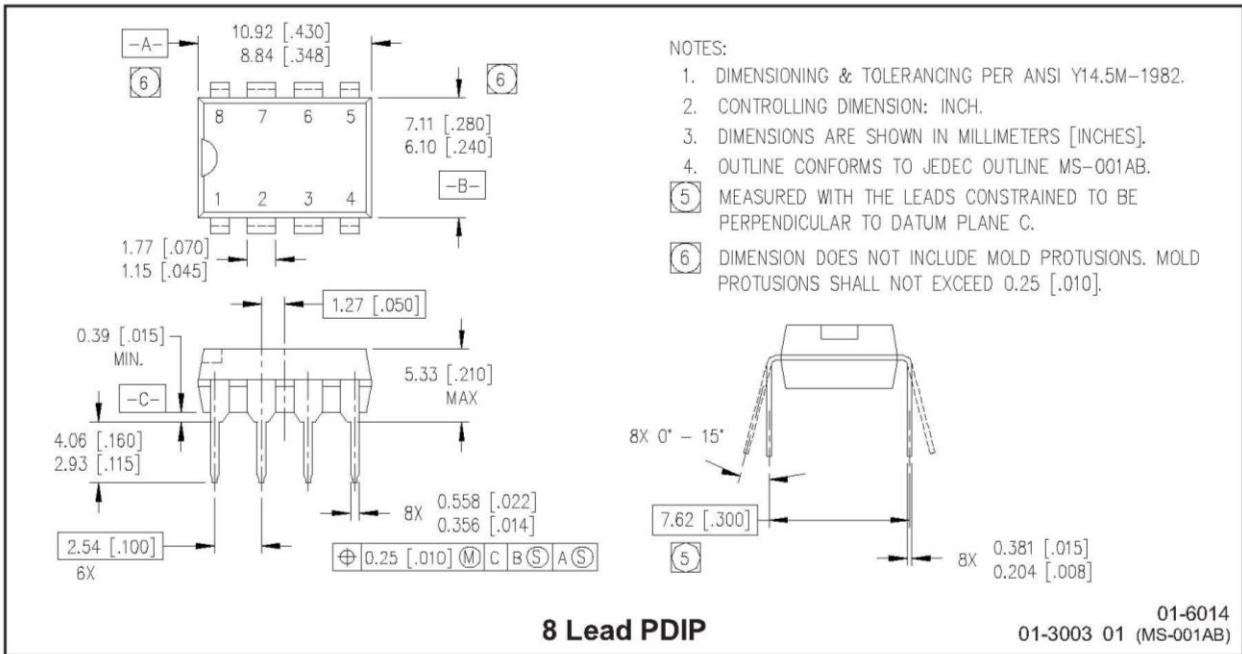
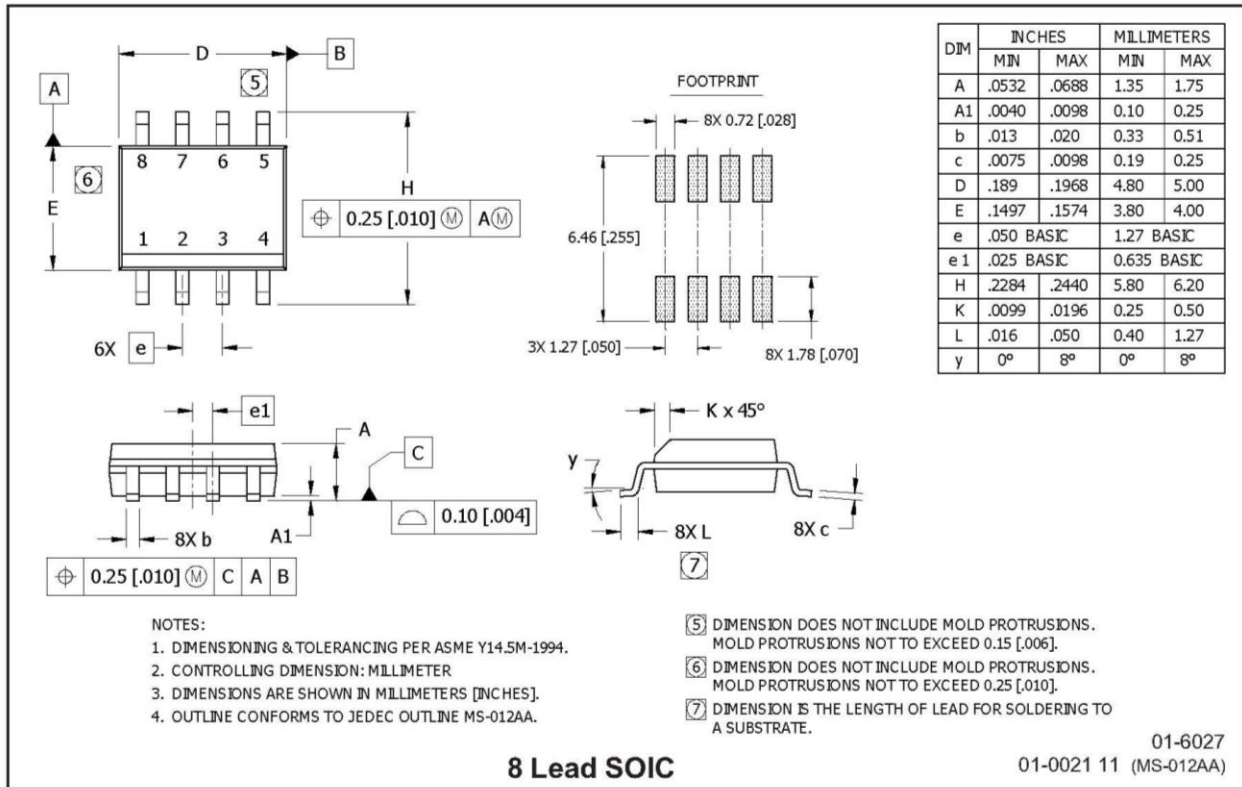

Figure 20B. Output Sink Current vs. Voltage

Package Details: PDIP8, SO8N



8 Lead PDIP



8 Lead SOIC

Tape and Reel Details: SO8N

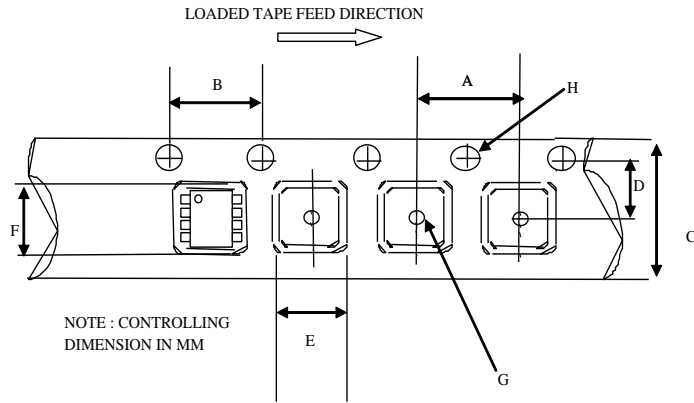

CARRIER TAPE DIMENSION FOR 8SOICN

| Code | Metric | | Imperial | |
|------|--------|-------|----------|-------|
| | Min | Max | Min | Max |
| A | 7.90 | 8.10 | 0.311 | 0.318 |
| B | 3.90 | 4.10 | 0.153 | 0.161 |
| C | 11.70 | 12.30 | 0.46 | 0.484 |
| D | 5.45 | 5.55 | 0.214 | 0.218 |
| E | 6.30 | 6.50 | 0.248 | 0.255 |
| F | 5.10 | 5.30 | 0.200 | 0.208 |
| G | 1.50 | n/a | 0.059 | n/a |
| H | 1.50 | 1.60 | 0.059 | 0.062 |

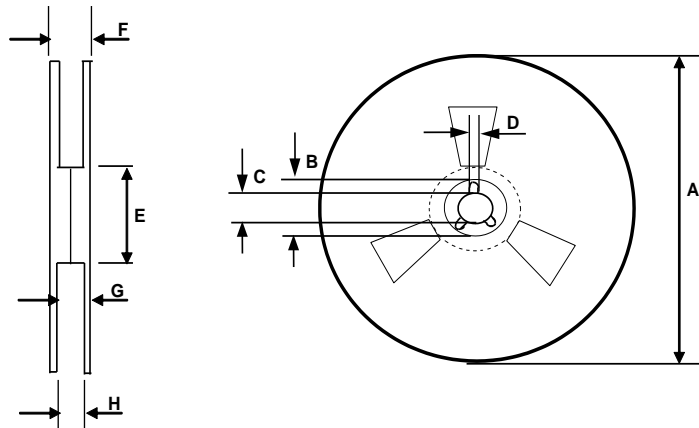

REEL DIMENSIONS FOR 8SOICN

| Code | Metric | | Imperial | |
|------|--------|--------|----------|--------|
| | Min | Max | Min | Max |
| A | 329.60 | 330.25 | 12.976 | 13.001 |
| B | 20.95 | 21.45 | 0.824 | 0.844 |
| C | 12.80 | 13.20 | 0.503 | 0.519 |
| D | 1.95 | 2.45 | 0.767 | 0.096 |
| E | 98.00 | 102.00 | 3.858 | 4.015 |
| F | n/a | 18.40 | n/a | 0.724 |
| G | 14.50 | 17.10 | 0.570 | 0.673 |
| H | 12.40 | 14.40 | 0.488 | 0.566 |

Part Marking Information

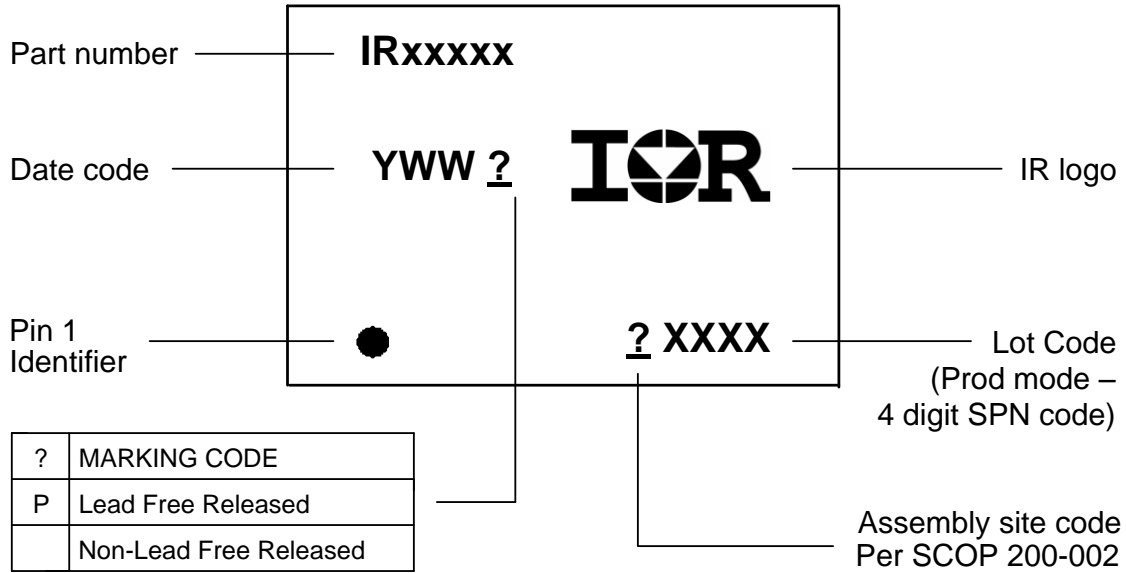

Qualification Information[†]

| | | |
|-----------------------------------|---|---|
| Qualification Level | Industrial ^{††} (per JEDEC JESD 47) | |
| | Comments: This family of ICs has passed JEDEC's Industrial qualification. IR's Consumer qualification level is granted by extension of the higher Industrial level. | |
| Moisture Sensitivity Level | SOIC8N | MSL2 ^{†††} (per IPC/JEDEC J-STD 020) |
| | PDIP8 | Not applicable (non-surface mount package style) |
| RoHS Compliant | Yes | |

- † Qualification standards can be found at International Rectifier's web site <http://www.irf.com/>
- †† Higher qualification ratings may be available should the user have such requirements. Please contact your International Rectifier sales representative for further information.
- ††† Higher MSL ratings may be available for the specific package types listed here. Please contact your International Rectifier sales representative for further information.

The information provided in this document is believed to be accurate and reliable. However, International Rectifier assumes no responsibility for the consequences of the use of this information. International Rectifier assumes no responsibility for any infringement of patents or of other rights of third parties which may result from the use of this information. No license is granted by implication or otherwise under any patent or patent rights of International Rectifier. The specifications mentioned in this document are subject to change without notice. This document supersedes and replaces all information previously supplied.

For technical support, please contact IR's Technical Assistance Center
<http://www.irf.com/technical-info/>

WORLD HEADQUARTERS:
 233 Kansas St., El Segundo, California 90245
 Tel: (310) 252-7105



**Стандарт
Электрон
Связь**

Мы молодая и активно развивающаяся компания в области поставок электронных компонентов. Мы поставляем электронные компоненты отечественного и импортного производства напрямую от производителей и с крупнейших складов мира.

Благодаря сотрудничеству с мировыми поставщиками мы осуществляем комплексные и плановые поставки широчайшего спектра электронных компонентов.

Собственная эффективная логистика и склад в обеспечивает надежную поставку продукции в точно указанные сроки по всей России.

Мы осуществляем техническую поддержку нашим клиентам и предпродажную проверку качества продукции. На все поставляемые продукты мы предоставляем гарантию .

Осуществляем поставки продукции под контролем ВП МО РФ на предприятия военно-промышленного комплекса России , а также работаем в рамках 275 ФЗ с открытием отдельных счетов в уполномоченном банке. Система менеджмента качества компании соответствует требованиям ГОСТ ISO 9001.

Минимальные сроки поставки, гибкие цены, неограниченный ассортимент и индивидуальный подход к клиентам являются основой для выстраивания долгосрочного и эффективного сотрудничества с предприятиями радиоэлектронной промышленности, предприятиями ВПК и научно-исследовательскими институтами России.

С нами вы становитесь еще успешнее!

Наши контакты:

Телефон: +7 812 627 14 35

Электронная почта: sales@st-electron.ru

Адрес: 198099, Санкт-Петербург,
Промышленная ул, дом № 19, литера Н,
помещение 100-Н Офис 331