

HLMP-Pxxx Series, HLMP-Qxxx Series HLMP-6xxx Series, HLMP-70xx Series Subminiature LED Lamps



Data Sheet

Description

Flat Top Package

The HLMP-Pxxx Series flat top lamps use an untinted, non-diffused, truncated lens to provide a wide radiation pattern that is necessary for use in backlighting applications. The flat top lamps are also ideal for use as emitters in light pipe applications.

Dome Packages

The HLMP-6xxx Series dome lamps for use as indicators use a tinted, diffused lens to provide a wide viewing angle with a high on-off contrast ratio. High brightness lamps use an untinted, nondiffused lens to provide a high luminous intensity within a narrow radiation pattern.

Resistor Lamps

The HLMP-6xxx Series 5 volt subminiature lamps with built in current limiting resistors are for use in applications where space is at a premium.

Lead Configurations

All of these devices are made by encapsulating LED chips on axial lead frames to form molded epoxy subminiature lamp packages. A variety of package configuration options is available. These include special surface mount lead configurations, gull wing, yoke lead or Z-bend. Right angle lead bends at 2.54 mm (0.100 inch) and 5.08 mm (0.200 inch) center spacing are available for through hole mounting. For more information refer to Standard SMT and Through Hole Lead Bend Options for Subminiature LED Lamps data sheet.

Features

- Subminiature flat top package
 - ideal for backlighting and light piping applications
- Subminiature dome package
 - diffused dome for wide viewing angle
 - nondiffused dome for high brightness
- TTL and LSTTL compatible 5 volt resistor lamps
- Available in six colors
- Ideal for space limited applications
- Axial leads
- Available with lead configurations for surface mount and through hole PC board mounting

Device Selection Guide

Part Number: HLMP-xxxx

Standard Red	DH AS AlGaAs Red	High Efficiency Red	Orange	Yellow	High Perf. Green	Emerald Green	Device Description ^[1]	Device Outline Drawing
P005	P105	P205	P405	P305	P505	P605	Untinted, Nondiffused, Flat Top	A
	P102	P202	P402	P302	P502		Untinted, Diffused, Flat Top	A
6000	Q100	6300	Q400	6400	6500	Q600	Tinted, Diffused	B
	Q105	6305	Q405	6405	6505	Q605	Untinted, Nondiffused, High Brightness	B
	Q150	7000		7019	7040		Tinted, Diffused, Low Current	B
	Q155						Nondiffused, Low Current	B
		6600		6700	6800		Tinted, Diffused, Resistor, 5 V, 10 mA	B
		6620		6720	6820		Diffused, Resistor, 5 V, 4 mA	B

Ordering Information

HLMX-XXXX-X X X X X

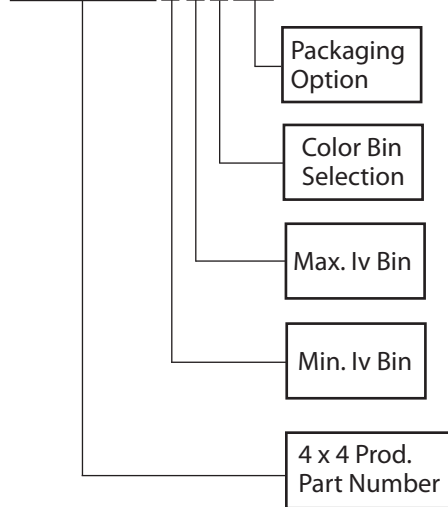

Package Dimensions (A) Flat Top Lamps

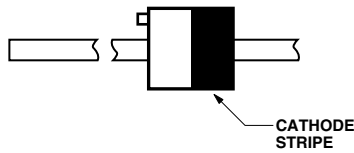
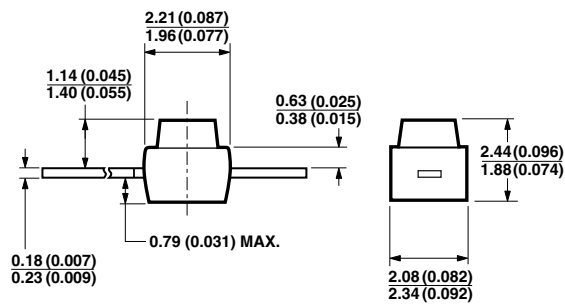
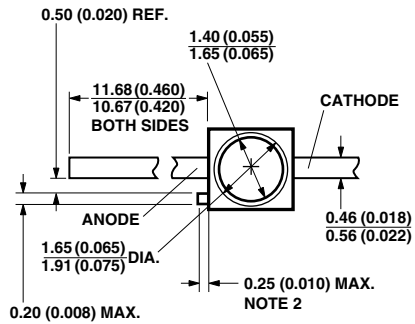

(B) Diffused and Nondiffused

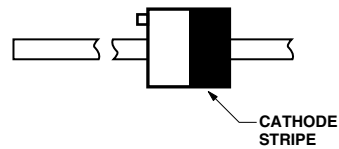
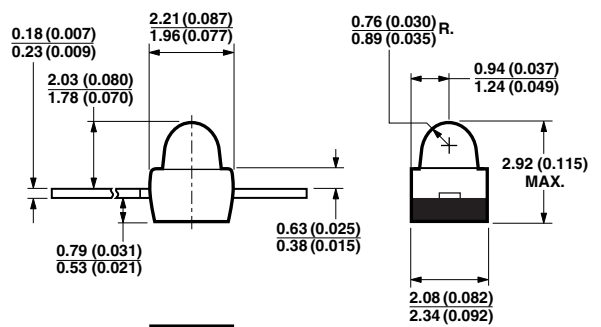
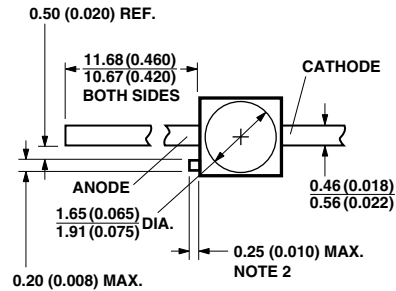

NOTES:

1. ALL DIMENSIONS ARE IN MILLIMETRES (INCHES).
2. PROTRUDING SUPPORT TAB IS CONNECTED TO CATHODE LEAD.
3. LEAD POLARITY FOR AlGaAs LAMPS IS OPPOSITE TO THE LEAD POLARITY OF SUBMINIATURE LAMPS USING OTHER TECHNOLOGIES.

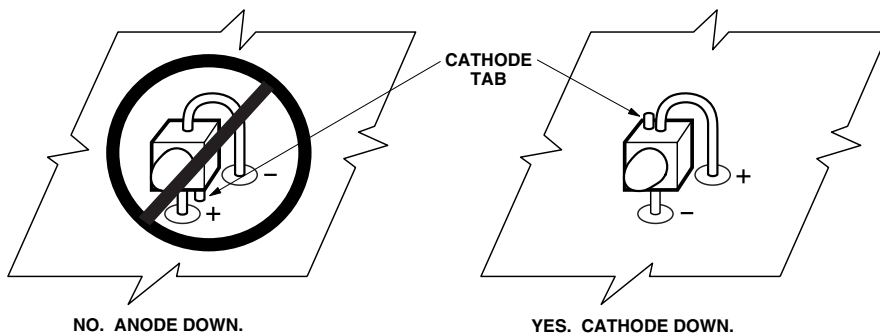

Figure 1. Proper right angle mounting to a PC board to prevent protruding cathode tab from shorting to anode connection.

Absolute Maximum Ratings at $T_A = 25^\circ\text{C}$

Parameter	Standard Red	DH AS AlGaAs Red	High Eff. Red	Orange	Yellow	High Perf. Green	Emerald Green	Units
DC Forward Current ^[1]	50	30	30	30	20	30	30	mA
Peak Forward Current ^[2]	1000	300	90	90	60	90	90	mA
DC Forward Voltage (Resistor Lamps Only)			6		6	6	6	V
Reverse Voltage ($I_R = 100 \mu\text{A}$)	5	5	5	5	5	5	5	V
Transient Forward Current ^[3] (10 μs Pulse)	2000	500	500	500	500	500	500	mA
Operating Temperature Range:								
Non-Resistor Lamps	-55 to +100	-40 to +100		55 to +100		-40 to +100	-20 to +100	$^\circ\text{C}$
Resistor Lamps				-40 to +85			-20 to +85	
Storage Temperature Range				-55 to +100				$^\circ\text{C}$
For Thru Hole Devices Wave Soldering Temperature [1.6 mm (0.063 in.) from body]				260 $^\circ\text{C}$ for 5 seconds				
For Surface Mount Devices: Reflow Soldering Temperature				260 $^\circ\text{C}$ for 20 seconds				

Notes:

1. See Figure 5 for current derating vs. ambient temperature. Derating is not applicable to resistor lamps.
2. Refer to Figure 6 showing Max. Tolerable Peak Current vs. Pulse Duration to establish pulsed operating conditions.
3. The transient peak current is the maximum non-recurring peak current the device can withstand without failure. Do not operate these lamps at this high current.

Electrical/Optical Characteristics, $T_A = 25^\circ\text{C}$

Standard Red

Device HLMP-	Parameter	Symbol	Min.	Typ.	Max.	Units	Test Conditions
6000-E00xx			0.63	1.2			
6000-G00xx	Luminous Intensity ^[1]	I_V	1.60	3.2		mcd	$I_F = 10\text{ mA}$
P005-F00xx			1.0	2.5			
All	Forward Voltage	V_F	1.4	1.6	2.0	V	$I_F = 10\text{ mA}$
	Reverse Breakdown Voltage	V_R	5.0	12.0		V	$I_R = 100\ \mu\text{A}$
6000	Included Angle Between Half Intensity Points ^[2]	$2\theta^{1/2}$		90		Deg.	
P005				125			
All	Peak Wavelength	λ_{PEAK}		655		nm	
	Dominant Wavelength ^[3]	λ_d		640		nm	
	Spectral Line Half Width	$\Delta\lambda_{1/2}$		24		nm	
	Speed of Response	τ_s		15		ns	
	Capacitance	C		100		pF	$V_F = 0; f = 1\text{ MHz}$
	Thermal Resistance	$R\theta_{J-PIN}$		170		$^\circ\text{C/W}$	Junction-to-Cathode Lead
	Luminous Efficacy ^[4]	η_V		65		lm/W	

DH AS AlGaAs Red

Device HLMP-	Parameter	Symbol	Min.	Typ.	Max.	Units	Test Conditions	
P102-F00xx	Luminous Intensity	I_V	1.0	20.0		mcd	$I_F = 20 \text{ mA}$	
P105-L00xx			10.0	30.0				
P105-NP000			25		80			
Q100-M00xx			16	45				
Q100-N00xx			25.0	45.0				
Q100-PQ000			40		125			
Q105-P00xx			40	200				
Q105-ST000			160		500			
Q150-F00xx			1.0	1.8				$I_F = 1 \text{ mA}$
Q155-F00xx			1.0	4.0				
Q100	Forward Voltage	V_F		1.8	2.2	V	$I_F = 20 \text{ mA}$	
Q150/Q155				1.6	1.8		$I_F = 1 \text{ mA}$	
All	Reverse Breakdown Voltage	V_R	5.0	15.0		V	$I_R = 100 \mu\text{A}$	
P105	Included Angle Between Half Intensity Points ^[2]	$2\theta^{1/2}$		125		Deg.		
Q100/Q150				90				
Q105/Q155				28				
All	Peak Wavelength	λ_{PEAK}		645		nm	Measured at Peak	
	Dominant Wavelength ^[3]	λ_d		637		nm		
	Spectral Line Half Width	$\Delta\lambda_{1/2}$		20		nm		
	Speed of Response	τ_s		30		ns	Exponential Time Constant; e^{-t/τ_s}	
	Capacitance	C		30		pF	$V_F = 0$; $f = 1 \text{ MHz}$	
	Thermal Resistance	$R\theta_{J-PIN}$		170		$^{\circ}\text{C}/\text{W}$	Junction-to Cathode Lead	
	Luminous Efficacy ^[4]	η_V		80		lm/W		

High Efficiency Red

Device HLMP-	Parameter	Symbol	Min.	Typ.	Max.	Units	Test Conditions	
P202-F00xx	Luminous Intensity ^[1]	I_V	1.0	5.0		mcd	$I_F = 10 \text{ mA}$	
P205-F00xx			1.0	8.0				
P205-JK000			4.0		12.5			
6300-F00xx			1.0	10.0				
6300-KL000			6.3		20.0			
6305-L00xx			10.0	40.0				
7000-D00xx			0.4	1.0				$I_F = 2 \text{ mA}$
6600-G00xx			1.6	5.0				$V_F = 5.0 \text{ Volts}$
6620-F00xx			1.0	2.0				
All	Forward Voltage (Nonresistor Lamps)	V_F	1.5	1.8	3.0	V	$I_F = 10 \text{ mA}$	
6600	Forward Current (Resistor Lamps)	I_F		9.6	13.0	mA	$V_F = 5.0 \text{ V}$	
6620				3.5	5.0			
All	Reverse Breakdown Voltage	V_R	5.0	30.0		V	$I_R = 100 \mu\text{A}$	
P205	Included Angle Between Half Intensity Points ^[2]	$2\theta^{1/2}$		125		Deg.		
6305				28				
All Diffused				90				
All	Peak Wavelength	λ_{PEAK}		635		nm	Measured at Peak	
	Dominant Wavelength ^[3]	λ_d		626		nm		
	Spectral Line Half Width	$\Delta\lambda_{1/2}$		40		nm		
	Speed of Response	τ_s		90		ns		
	Capacitance	C		11		pF	$V_F = 0; f = 1 \text{ MHz}$	
	Thermal Resistance	$R\theta_{J-PIN}$		170		$^{\circ}\text{C/W}$	Junction-to-Cathode Lead	
	Luminous Efficacy ^[4]	η_V		145		lm/W		

Orange

Device HLMP-	Parameter	Symbol	Min.	Typ.	Max.	Units	Test Conditions
P402-F00xx	Luminous Intensity	I_V	1.0	4.0		mcd	$I_F = 10 \text{ mA}$
P405-F00xx			1.0	6			
P405-JK000			4.0		12.5		
Q400-F00xx			1.0	8			
Q405-H00xx			2.5	14			
All	Forward Voltage	V_F	1.5	1.9	3.0	V	$I_F = 10 \text{ mA}$
	Reverse Breakdown Voltage	V_R	5.0	30.0		V	$I_R = 100 \mu\text{A}$
P40x	Included Angle Between	$2\theta^{1/2}$		125		Deg.	
Q40x	Half Intensity Points ^[2]			90			
	Peak Wavelength	λ_{PEAK}		600		nm	
	Dominant Wavelength ^[3]	λ_d		602		nm	Measured at Peak
	Spectral Line Half Width	$\Delta\lambda_{1/2}$		40		nm	
All	Speed of Response	τ_s		260		ns	
	Capacitance	C		4		pF	$V_F = 0; f = 1 \text{ MHz}$
	Thermal Resistance	$R\theta_{\text{J-PIN}}$		170		$^{\circ}\text{C/W}$	Junction-to-Cathode Lead
	Luminous Efficacy ^[4]	η_V		380		lm/W	

Yellow

Device HLMP-	Parameter	Symbol	Min.	Typ.	Max.	Units	Test Conditions	
P302-F00xx	Luminous Intensity ^[1]	I_V	1.0	3.0		mcd	$I_F = 10 \text{ mA}$	
P305-F00xx			1.0	4.0				
6400-F00xx			1.0	9.0				
6400-JK000			4.0		12.5			
6405-J00xx			3.6	20				
6405-MN0xx			16		50			
7019-D00xx			0.4	0.6				$I_F = 2 \text{ mA}$
6700-G00xx			1.4	5.0				$V_F = 5.0 \text{ Volts}$
6720-F00xx			0.9	2.0				
All	Forward Voltage (Nonresistor Lamps)	V_F		2.0	2.4	V	$I_F = 10 \text{ mA}$	
6700	Forward Current (Resistor Lamps)	I_F		9.6	13.0	mA	$V_F = 5.0 \text{ V}$	
6720				3.5	5.0			
All	Reverse Breakdown Voltage	V_R	5.0	50.0		V		
P305	Included Angle Between			125				
6405	Half Intensity Points ^[2]	$2\theta^{1/2}$		28		Deg.		
All Diffused				90				
All	Peak Wavelength	λ_{PEAK}		583		nm	Measured at Peak	
	Dominant Wavelength ^[3]	λ_d		585		nm		
	Spectral Line Half Width	$\Delta\lambda_{1/2}$		36		nm		
	Speed of Response	τ_s		90		ns		
	Capacitance	C		15		pF	$V_F = 0; f = 1 \text{ MHz}$	
	Thermal Resistance	$R\theta_{J-PIN}$		170		$^{\circ}\text{C/W}$	Junction-to-Cathode Lead	
	Luminous Efficacy ^[4]	η_V		500		lm/W		

High Performance Green

Device HLMP-	Parameter	Symbol	Min.	Typ.	Max.	Units	Test Conditions	
P502-F00xx	Luminous Intensity ^[1]	I_v	1.0	3.0		mcd	$I_F = 10 \text{ mA}$	
P505-G00xx			1.6	6.3				
6500-F00xx			1.0	7.0				
6505-L00xx			10.0	40.0				
7040-D00xx			0.4	0.6				$I_F = 2 \text{ mA}$
6800-G00xx			1.6	5.0				$V_F = 5.0 \text{ Volts}$
6820-F00xx			1.0	2.0				
All	Forward Voltage (Nonresistor Lamps)	V_F		2.1	2.7	V	$I_F = 10 \text{ mA}$	
6800	Forward Current (Resistor Lamps)	I_F		9.6	13.0	mA	$V_F = 5.0 \text{ V}$	
6820				3.5	5.0			
All	Reverse Breakdown Voltage	V_R	5.0	50.0		V	$I_R = 100 \mu\text{A}$	
P505	Included Angle Between			125				
6505	Half Intensity Points ^[2]	$2\theta^{1/2}$		28		Deg.		
All Diffused				90				
All	Peak Wavelength	λ_{PEAK}		565		nm		
	Dominant Wavelength ^[3]	λ_d		569		nm		
	Spectral Line Half Width	$\Delta\lambda_{1/2}$		28		nm		
All	Speed of Response	τ_s		500		ns		
	Capacitance	C		18		pF	$V_F = 0; f = 1 \text{ MHz}$	
	Thermal Resistance	$R\theta_{J-PIN}$		170		$^{\circ}\text{C/W}$	Junction-to-Cathode Lead	
	Luminous Efficacy ^[4]	η_v		595		lm/W		

Notes:

1. The luminous intensity for arrays is tested to assure a 2.1 to 1.0 matching between elements. The average luminous intensity for an array determines its light output category bin. Arrays are binned for luminous intensity to allow I_v matching between arrays.
2. $\theta^{1/2}$ is the off-axis angle where the luminous intensity is half the on-axis value.
3. Dominant wavelength, λ_d , is derived from the CIE Chromaticity Diagram and represents the single wavelength that defines the color of the device.
4. Radiant intensity, I_e , in watts/steradian, may be calculated from the equation $I_e = I_v/\eta_v$, where I_v is the luminous intensity in candelas and η_v is the luminous efficacy in lumens/watt.

Emerald Green^[1]

Device HLMP-	Parameter	Symbol	Min.	Typ.	Max.	Units	Test Conditions
P605-F00xx			1.0	1.5			
Q600-F00xx	Luminous Intensity	I_V	1.0	1.5		mcd	$I_F = 10 \text{ mA}$
Q605-F00xx			1.0	7.5			
All	Forward Voltage	V_F		2.2	3.0	V	$I_F = 10 \text{ mA}$
	Reverse Breakdown Voltage	V_R	5.0			V	$I_R = 100 \mu\text{A}$
P605	Included Angle Between	$2\theta^{1/2}$		125		Deg.	
Q60x	Half Intensity Points ^[2]			90			
P605/Q600	Peak Wavelength	λ_{PEAK}		558		nm	
	Dominant Wavelength ^[3]	λ_d		560		nm	Measured at Peak
	Spectral Line Half Width	$\Delta\lambda_{1/2}$		24		nm	
P605/Q600	Speed of Response	τ_s		3100		ns	
	Capacitance	C		35		pF	$V_F = 0; f = 1 \text{ MHz}$
	Thermal Resistance	$R\theta_{J-PIN}$		170		$^{\circ}\text{C/W}$	Junction-to-Cathode Lead
	Luminous Efficacy ^[4]	η_V		656		lm/W	

Note:

1. Please refer to Application Note 1061 for information comparing standard green and emerald green light output degradation.

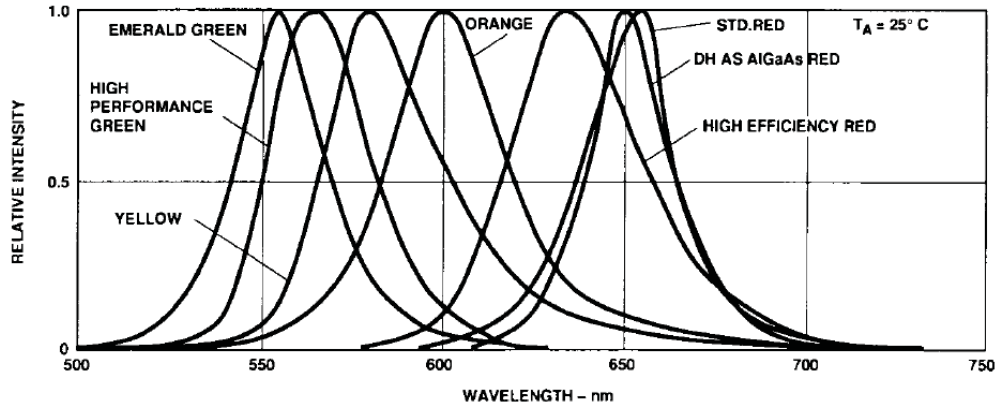

Figure 1. Relative intensity vs. wavelength.

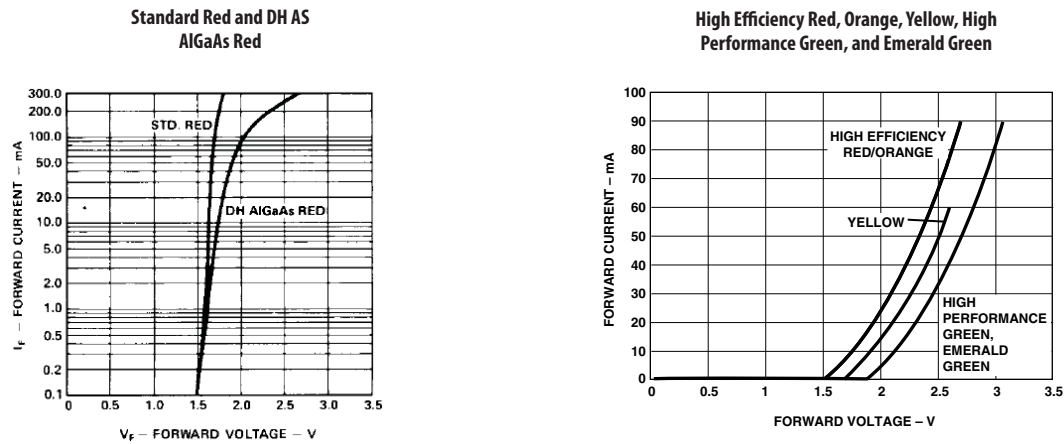

Figure 2. Forward current vs. forward voltage (non-resistor lamp).

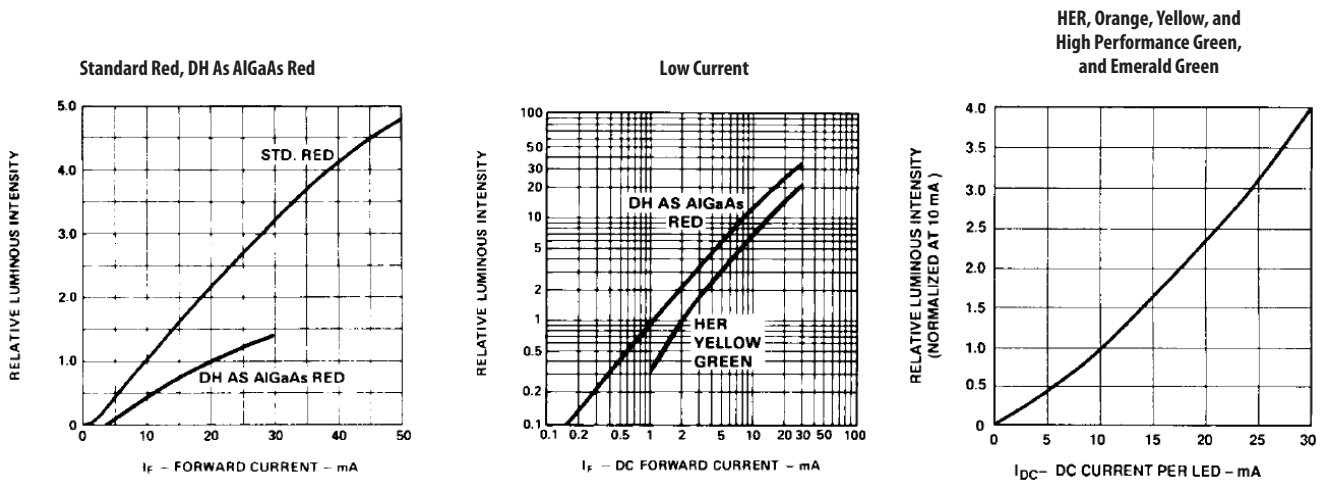

Figure 3. Relative luminous intensity vs. forward current (non-resistor lamp).

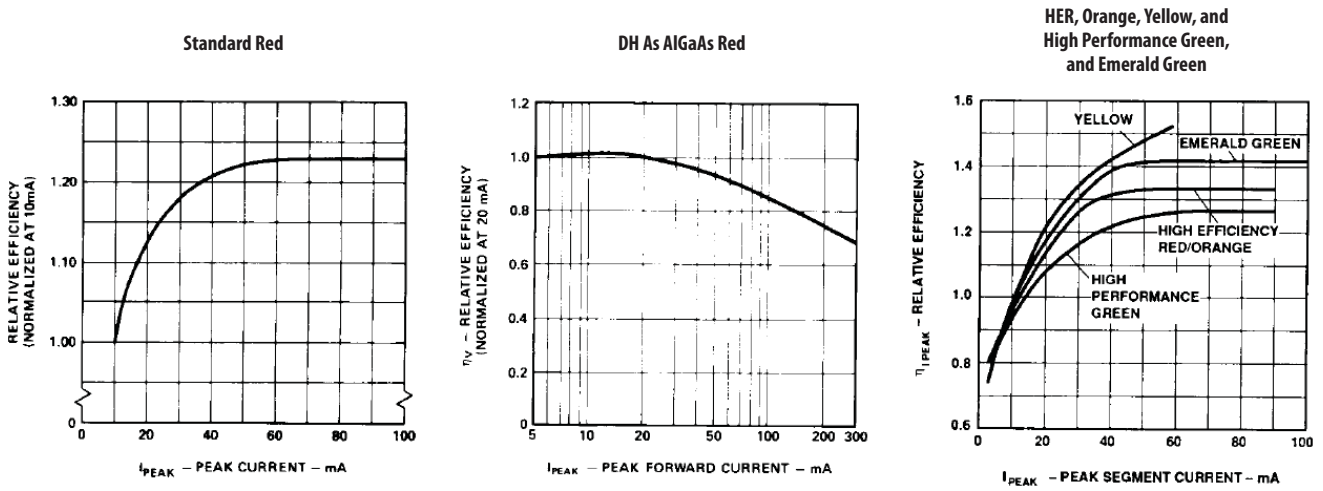

Figure 4. Relative efficiency (luminous intensity per unit current) vs. peak current (non-resistor lamps).

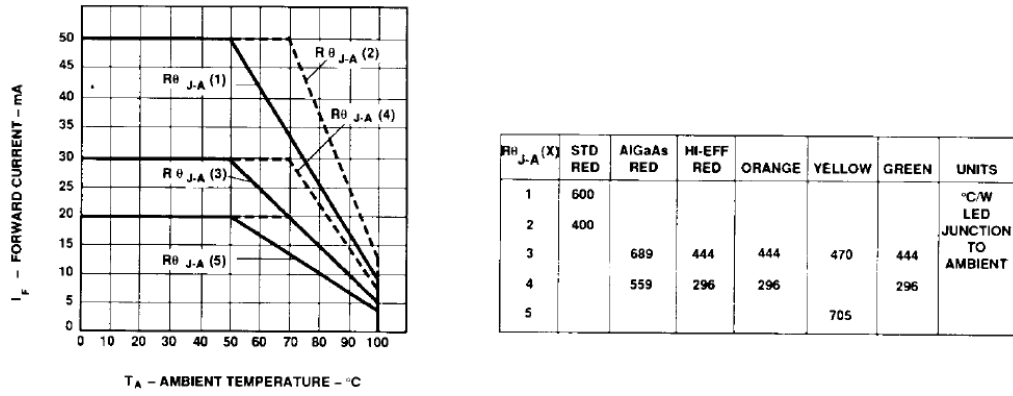

Figure 5. Maximum forward dc current vs. ambient temperature. Derating based on T_J MAX = 110°C (non-resistor lamps).

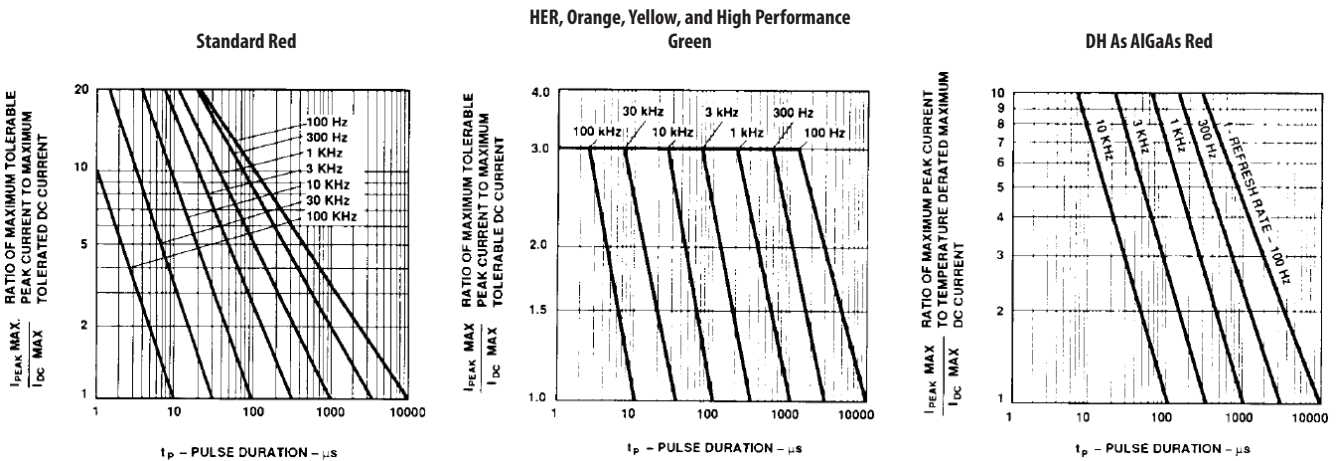

Figure 6. Maximum tolerable peak current vs. pulse duration (I_{DC} MAX as per MAX ratings) (non-resistor lamps).

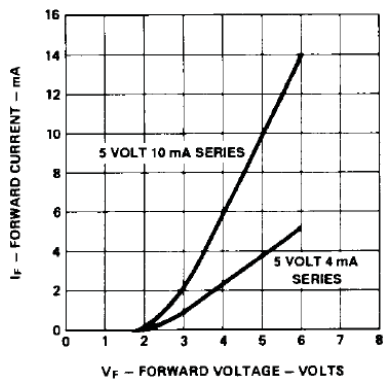

Figure 7. Resistor lamp forward current vs. forward voltage.

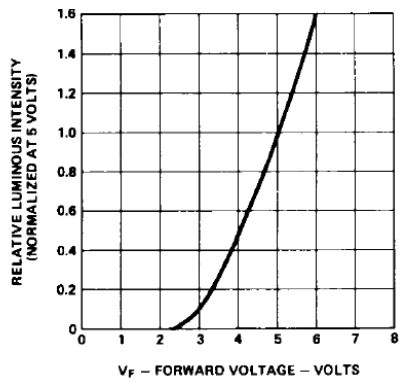

Figure 8. Resistor lamp luminous intensity vs. forward voltage.

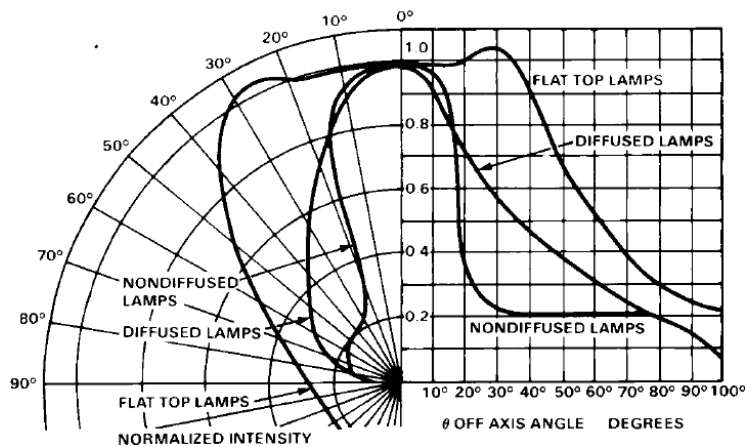
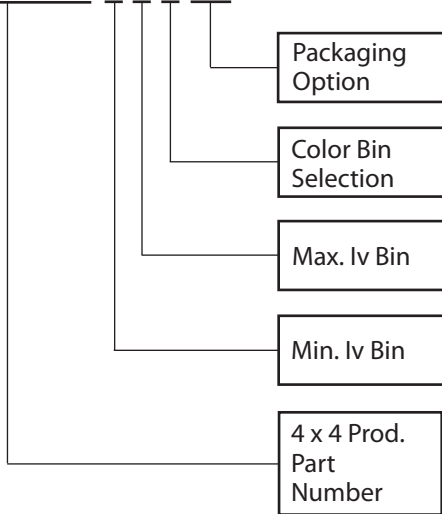

Figure 9. Relative intensity vs. angular displacement.

Ordering Information

HLM_x-XXXX-X X X X X



Intensity Bin Limits

Bin	Min.	Max.
A	0.10	0.20
B	0.16	0.32
C	0.25	0.50
D	0.40	0.80
E	0.63	1.25
F	1.00	2.00
G	1.60	3.20
H	2.50	5.00
J	4.00	8.00
K	6.30	12.50
L	10.00	20.00
M	16.00	32.00
N	25.00	50.00
P	40.00	80.00
Q	63.00	125.00
R	100.00	200.00
S	160.00	320.00
T	250.00	500.00
U	400.00	800.00
V	630.00	1250.00
W	1000.00	2000.00
X	1600.00	3200.00
Y	2500.00	5000.00

Color Bin Limits

Package	Bin	Min.	Max.
Emerald Green	0	Full Distribution	
	9	552	556
	8	555	559
	7	558	562
	6	561	565
Green	0	Full Distribution	
	6	561	565
	5	564	568
	4	567	571
	3	570	574
	2	573	577
	0	Full Distribution	
Yellow	0	Full Distribution	
	1	581.5	585.0
	3	584.0	587.5
	2	586.5	590.0
	4	589.0	592.5
	5	591.5	593.5
	6	591.5	595.0
	7	594.0	597.5
Orange	0	Full Distribution	
	1	596.5	600.0
	2	599.0	602.5
	3	601.5	604.0
	4	603.8	608.2
	5	606.8	611.2
	6	609.8	614.2
	7	612.8	617.2
	8	615.8	620.2

Mechanical Option

00	Straight Leads, Bulk Packaging, Quantity of 500 Parts
10	Right Angle Housing, Bulk Packaging, Quantity of 500 Parts
11	Gull Wing Leads, 12 mm Tape on 7 in. Dia. Reel, 1500 Parts per Reel
12	Gull Wing Lead, Bulk Packaging, Quantity of 500 Parts
14	Gull Wing Leads, 12 mm Tape on 13 in. Dia. Reel, 6000 Parts per Reel
21	Yoke Leads, 12 mm Tape on 7 in. Dia. Reel, 1500 Parts per Reel
22	Yoke Leads, Bulk Packaging, Quantity of 500 Parts
24	Yoke Leads, 12 mm Tape on 13 in. Dia. Reel, 6000 Parts per Reel
31	Z-Bend Leads, 12 mm Tape on 7 in. Dia. Reel, 1500 Parts per Reel
32	Z-Bend Leads, Bulk Packaging, Quantity of 500 Parts
34	Z-Bend Leads, 12 mm Tape on 13 in. Dia. Reel, 6000 Parts per Reel
1L	2.54 mm (0.100 inch) Center Lead Spacing, Long Leads; 10.4 mm (0.410 in.)
1S	2.54 mm (0.100 inch) Center Lead Spacing, Short Leads; 3.7 mm (0.145 in.)
2L	5.08 mm (0.200 inch) Center Lead Spacing, Long Leads; 10.4 mm (0.410 in.)
2S	5.08 mm (0.200 inch) Center Lead Spacing, Short Leads; 3.7 mm (0.145 in.)

Note:

All Categories are established for classification of products. Products may not be available in all categories. Please contact your local Avago representative for further clarification/information.

For product information and a complete list of distributors, please go to our web site: www.avagotech.com

Avago, Avago Technologies, and the A logo are trademarks of Avago Technologies in the United States and other countries. Data subject to change. Copyright © 2005-2012 Avago Technologies. All rights reserved. Obsoletes 5989-1708EN AV02-3609EN - June 12, 2012





Стандарт Электрон Связь

Мы молодая и активно развивающаяся компания в области поставок электронных компонентов. Мы поставляем электронные компоненты отечественного и импортного производства напрямую от производителей и с крупнейших складов мира.

Благодаря сотрудничеству с мировыми поставщиками мы осуществляем комплексные и плановые поставки широчайшего спектра электронных компонентов.

Собственная эффективная логистика и склад в обеспечивает надежную поставку продукции в точно указанные сроки по всей России.

Мы осуществляем техническую поддержку нашим клиентам и предпродажную проверку качества продукции. На все поставляемые продукты мы предоставляем гарантию .

Осуществляем поставки продукции под контролем ВП МО РФ на предприятия военно-промышленного комплекса России , а также работаем в рамках 275 ФЗ с открытием отдельных счетов в уполномоченном банке. Система менеджмента качества компании соответствует требованиям ГОСТ ISO 9001.

Минимальные сроки поставки, гибкие цены, неограниченный ассортимент и индивидуальный подход к клиентам являются основой для выстраивания долгосрочного и эффективного сотрудничества с предприятиями радиоэлектронной промышленности, предприятиями ВПК и научно-исследовательскими институтами России.

С нами вы становитесь еще успешнее!

Наши контакты:

Телефон: +7 812 627 14 35

Электронная почта: sales@st-electron.ru

Адрес: 198099, Санкт-Петербург,
Промышленная ул, дом № 19, литера Н,
помещение 100-Н Офис 331