



■ Features

- Input range 180~264VAC
- Class II power unit, no FG
- Built-in active PFC function
- High efficiency up to 90.5%
- No load power consumption <0.15W
- Energy efficiency Level VI
- Comply with EU ErP
- Compliance to IEC/EN 61558-1,-2-16 and IEC/EN 60335-1 (except for OWA-120E-48,54) for household appliance
- Fanless design, cooling by free air convection
- Protections: Short circuit / Overload / Over voltage / Over temperature
- 5 years warranty

■ Applications

- Robotic lawn mower
- Household appliance
- Battery charging
- General electronic products in dusty or humid environment

■ Description

OWA-120E is a 120W AC/DC, class II (no FG) external power supply series pinpointing the moistureproof feature. The fully-potted silicone inside the plastic enclosure enhances the heat dissipation; it also benefits that the power body of OWA-120E achieves IP67 level so that this series specializes the application in which the damp, humidity or dust resistance is needed for the external power supply. OWA-120E follows the latest energy efficiency demand with the no load power consumption less than 0.15W. It is certified with EN61558-2-16; moreover, the compliance to EN60335-1 for selected models can greatly simplify the system design such as household appliances.

OWA-120E adopts the input range from 180VAC to 264VAC and incorporates a built-in PFC function. With the working efficiency up to 90.5%, OWA-120E is cooled by free air convection; the working temperature ranges from -40°C to +70°C.

■ Model Encoding

OWA - 120E - 12

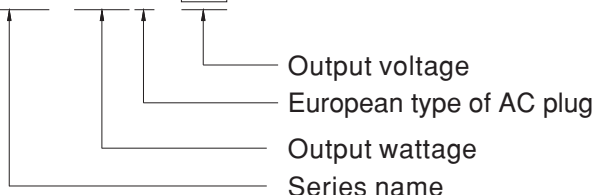



SPECIFICATION

MODEL		OWA-120E-12	OWA-120E-15	OWA-120E-20	OWA-120E-24	OWA-120E-30	OWA-120E-36	OWA-120E-42	OWA-120E-48	OWA-120E-54	
OUTPUT	DC VOLTAGE	12V	15V	20V	24V	30V	36V	42V	48V	54V	
	RATED CURRENT	9.6A	8A	6A	5A	4A	3.4A	2.9A	2.5A	2.3A	
	RATED POWER	115.2W	120W	120W	120W	120W	122.4W	121.8W	120W	124.2W	
	RIPPLE & NOISE (max.) Note.2	150mVp-p	150mVp-p	150mVp-p	150mVp-p	200mVp-p	200mVp-p	250mVp-p	250mVp-p	350mVp-p	
	VOLTAGE TOLERANCE Note.3	±4.0%	±4.0%	±4.0%	±4.0%	±3.0%	±2.0%	±1.0%	±1.0%	±1.0%	
	LINE REGULATION	±0.5%	±0.5%	±0.5%	±0.5%	±0.5%	±0.5%	±0.5%	±0.5%	±0.5%	
	LOAD REGULATION	±2.0%	±1.5%	±1.0%	±0.5%	±0.5%	±0.5%	±0.5%	±0.5%	±0.5%	
	SETUP, RISE TIME Note.4	500ms, 80ms at 95% load 230VAC									
	HOLD UP TIME (Typ.)	16ms at full load 230VAC									
INPUT	VOLTAGE RANGE	180 ~ 264VAC		254 ~ 370VDC							
	FREQUENCY RANGE	47 ~ 63Hz									
	POWER FACTOR (Typ.)	PF>0.96/230VAC at full load									
	EFFICIENCY (Typ.)	87.5%	89%	90%	90.5%	90%	90%	90.5%	90.5%	90.5%	
	AC CURRENT (Typ.)	0.65A / 230VAC									
	INRUSH CURRENT (Typ.)	COLD START 60A(twidth=520µs measured at 50% Ipeak) at 230VAC									
	LEAKAGE CURRENT	<0.25mA / 240VAC									
PROTECTION	OVERLOAD	105 ~ 115% Protection type : Hiccup mode, recovers automatically after fault condition is removed									
	SHORT CIRCUIT	Hiccup mode, recovers automatically after fault condition is removed									
	OVER VOLTAGE	15 ~ 17V	17.5 ~ 21V	23 ~ 27V	28 ~ 34V	34 ~ 40V	41 ~ 46V	46 ~ 54V	54 ~ 60V	59 ~ 66V	
		Protection type : Shut down o/p voltage, re-power on to recover									
	OVER TEMPERATURE	Shut down o/p voltage, re-power on to recover									
ENVIRONMENT	WORKING TEMP.	-40 ~ +70°C (Refer to "Derating Curve")									
	WORKING HUMIDITY	20 ~ 95% RH non-condensing									
	STORAGE TEMP., HUMIDITY	-40 ~ +80°C, 10 ~ 95% RH									
	TEMP. COEFFICIENT	±0.03%/°C (0 ~ 40°C)									
	VIBRATION	10 ~ 500Hz, 5G 12min./1cycle, period for 72min. each along X, Y, Z axes									
SAFETY & EMC	SAFETY STANDARDS	DEKRA EN61558-1,-2-16; DEKRA EN60335-1 (except for OWA-120E-48,54); IP67 (for power body) approved									
	WITHSTAND VOLTAGE	I/P-O/P:3.75KVAC									
	ISOLATION RESISTANCE	I/P-O/P:100M Ohms / 500VDC / 25°C / 70% RH									
	EMC EMISSION	Compliance to EN55022 (CISPR22) Class B, EN55014-1, EN61000-3-2,-3									
	EMC IMMUNITY	Compliance to EN61000-4-2,3,4,5,6,8,11, EN55014-2, EN55024, light industry level (surge L- N : 2KV), criteria A									
OTHERS	MTBF	294.3K hrs min. MIL-HDBK-217F (25°C)									
	DIMENSION	191*63*37.5mm									
	PACKING	1.15Kg; 12pcs/14.8Kg/0.89CUFT									
NOTE	<p>1. All parameters NOT specially mentioned are measured at 230VAC input, rated load and 25°C of ambient temperature.</p> <p>2. Ripple & noise are measured at 20MHz of bandwidth by using a 12" twisted pair-wire terminated with a 0.1uf & 47uf parallel capacitor.</p> <p>3. Tolerance : includes set up tolerance, line regulation and load regulation.</p> <p>4. Length of set up time is measured at cold first start. Turning ON/OFF the power supply may lead to increase of the set up time.</p>										

■ Block Diagram

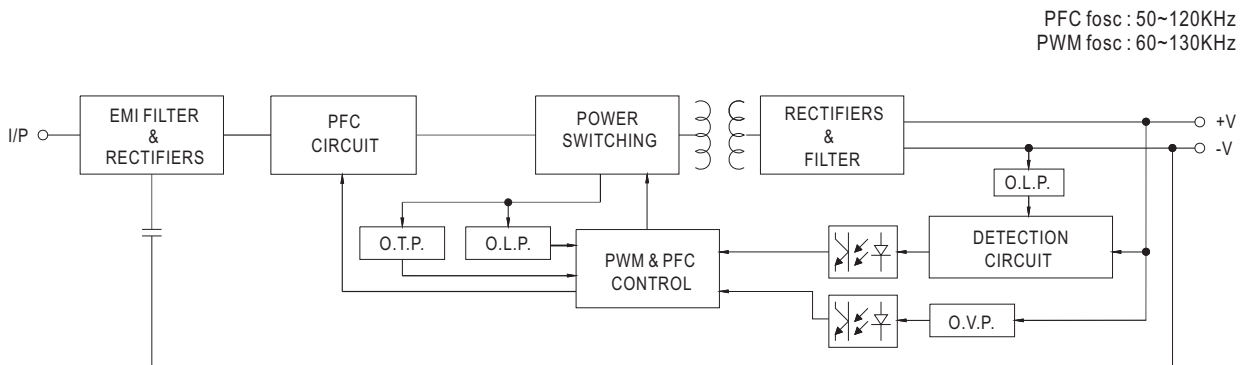

■ Derating Curve

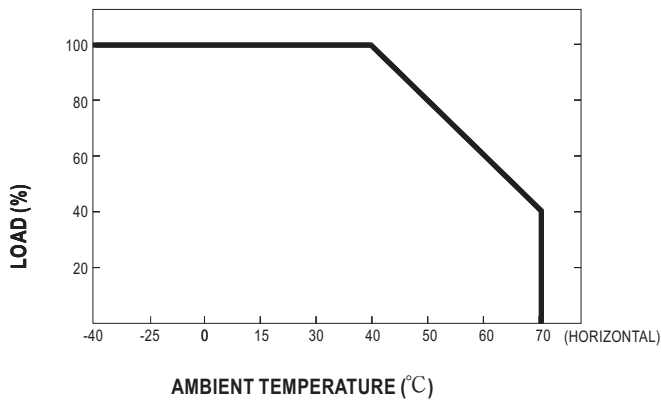

■ Static Characteristics

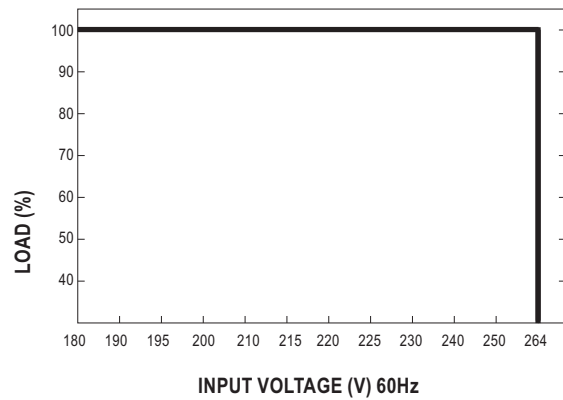

Mechanical Specification

Case No. PWM-120

Unit:mm

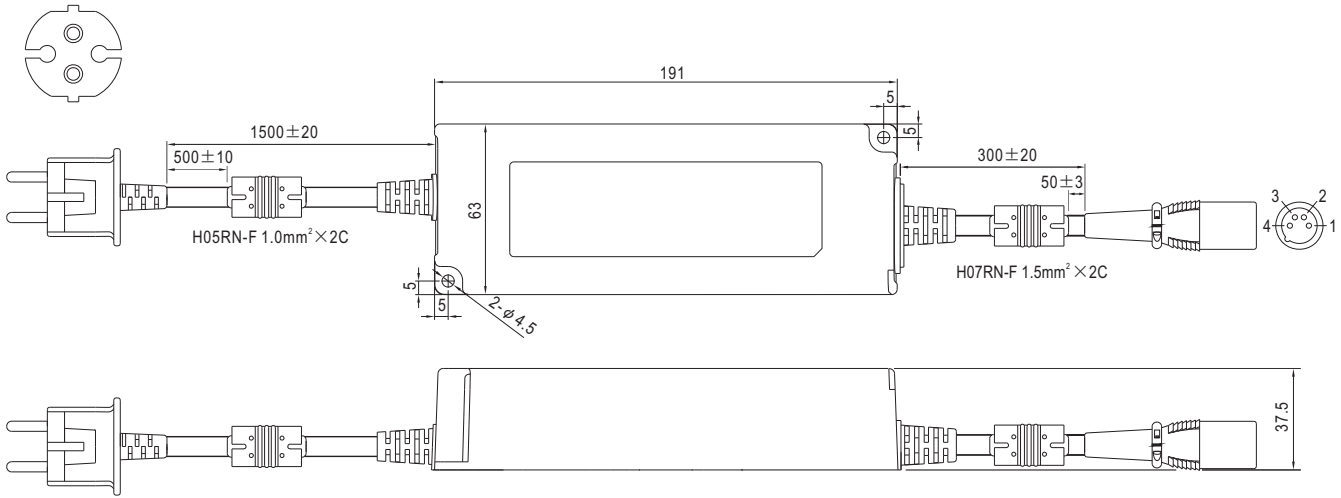





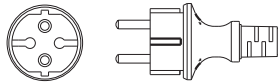



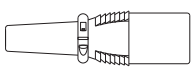

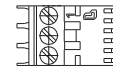

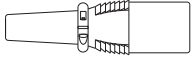

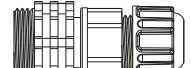

Input Plug Type

All standard models : CEE 7/7

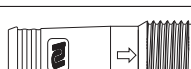

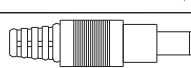
Output Plug Assignment

Model Category	Plug Description	Plug Picture	PIN NO.	OUTPUT	
For standard model	XLR 4P, NEUTRIK NC4MX, or equivalent			1,2	+V
				3,4	-V
For optional model	Lumberg 3611 03, or equivalent			1	+V
				2	float
				3	-V
For optional model	XLR 3P, NEUTRIK NC3MX, or equivalent			1	+V
				2,3	-V
For optional model	CHOGORI 22002411-01 or equivalent			1	+V
				2	-V
For optional model	CHOGORI 23002411-01 or equivalent			1	+V
				2	-V
For optional model	Unicable UT-D170F4-2P or equivalent			1	+V
				2	-V
For optional model	Unicable UT-D224-2P or equivalent			1	+V
				2	-V
For optional model	2.1φ x 5.5φ x 11 mm, center +, tuning fork type	 Outside ⊖ ⊕ Inside		CENTER	+V

※ For details, please contact MEAN WELL.

Installation Manual

Please refer to : <http://www.meanwell.com/webnet/search/InstallationSearch.html>



Стандарт Электрон Связь

Мы молодая и активно развивающаяся компания в области поставок электронных компонентов. Мы поставляем электронные компоненты отечественного и импортного производства напрямую от производителей и с крупнейших складов мира.

Благодаря сотрудничеству с мировыми поставщиками мы осуществляем комплексные и плановые поставки широчайшего спектра электронных компонентов.

Собственная эффективная логистика и склад в обеспечивает надежную поставку продукции в точно указанные сроки по всей России.

Мы осуществляем техническую поддержку нашим клиентам и предпродажную проверку качества продукции. На все поставляемые продукты мы предоставляем гарантию .

Осуществляем поставки продукции под контролем ВП МО РФ на предприятия военно-промышленного комплекса России , а также работаем в рамках 275 ФЗ с открытием отдельных счетов в уполномоченном банке. Система менеджмента качества компании соответствует требованиям ГОСТ ISO 9001.

Минимальные сроки поставки, гибкие цены, неограниченный ассортимент и индивидуальный подход к клиентам являются основой для выстраивания долгосрочного и эффективного сотрудничества с предприятиями радиоэлектронной промышленности, предприятиями ВПК и научно-исследовательскими институтами России.

С нами вы становитесь еще успешнее!

Наши контакты:

Телефон: +7 812 627 14 35

Электронная почта: sales@st-electron.ru

Адрес: 198099, Санкт-Петербург,
Промышленная ул, дом № 19, литера Н,
помещение 100-Н Офис 331