

PWM TYPE 3-PHASE DC BRUSHLESS MOTOR CONTROL IC

◆ GENERAL DESCRIPTION

The **NJM2625A** is a 3-phase DC brush-less motor control IC with PWM control.

It incorporates hall amplifiers, PWM control circuits, totem-pole pre drivers for external power MOS transistors, current limit and frequency generator circuit.

The NJM2625A easily implements speed control and rotation direction control for DC motor application.

◆ PACKAGE OUTLINE

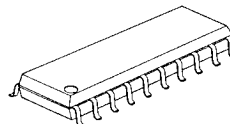

NJM2625AM

◆ FEATURES

- Operating Voltage (V⁺=8V to 18V)
- Pre-Driver Circuit (I_{out}=+50mA/-150mA MAX.)
- Current Limit Sense Voltage (Current limit=0.5V±10%)
- Internal Oscillator (Frequency control for external capacitor)
- Forward or Reverse Direction
- FG Signal Output (Output frequency to hall frequency)
- Internal Soft Start (External capacitor to Verr pin.)
- Internal ON/OFF Circuit (No-output is Verr pin to GND.)
- Bipolar Technology
- Package Outline DMP20

◆ PIN CONFIGURATION

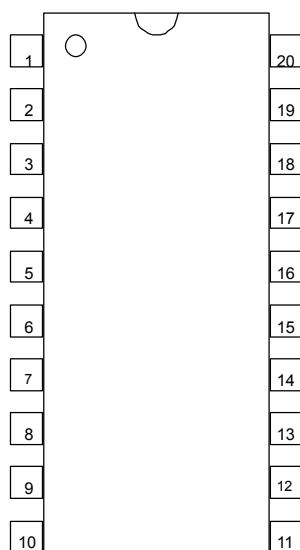

NJM2625AM

PIN FUNCTION

| | |
|--------|-----------------------|
| 1.FG | 11.GND |
| 2.Vref | 12.I _{LIMIT} |
| 3.H1+ | 13.WL |
| 4.H1- | 14.VL |
| 5.H2+ | 15.UL |
| 6.H2- | 16.WH |
| 7.H3+ | 17.VH |
| 8.H3- | 18.UH |
| 9.Verr | 19.V ⁺ |
| 10.OSC | 20.F/R |

NJM2625A

◆ BLOCK DIAGRAM

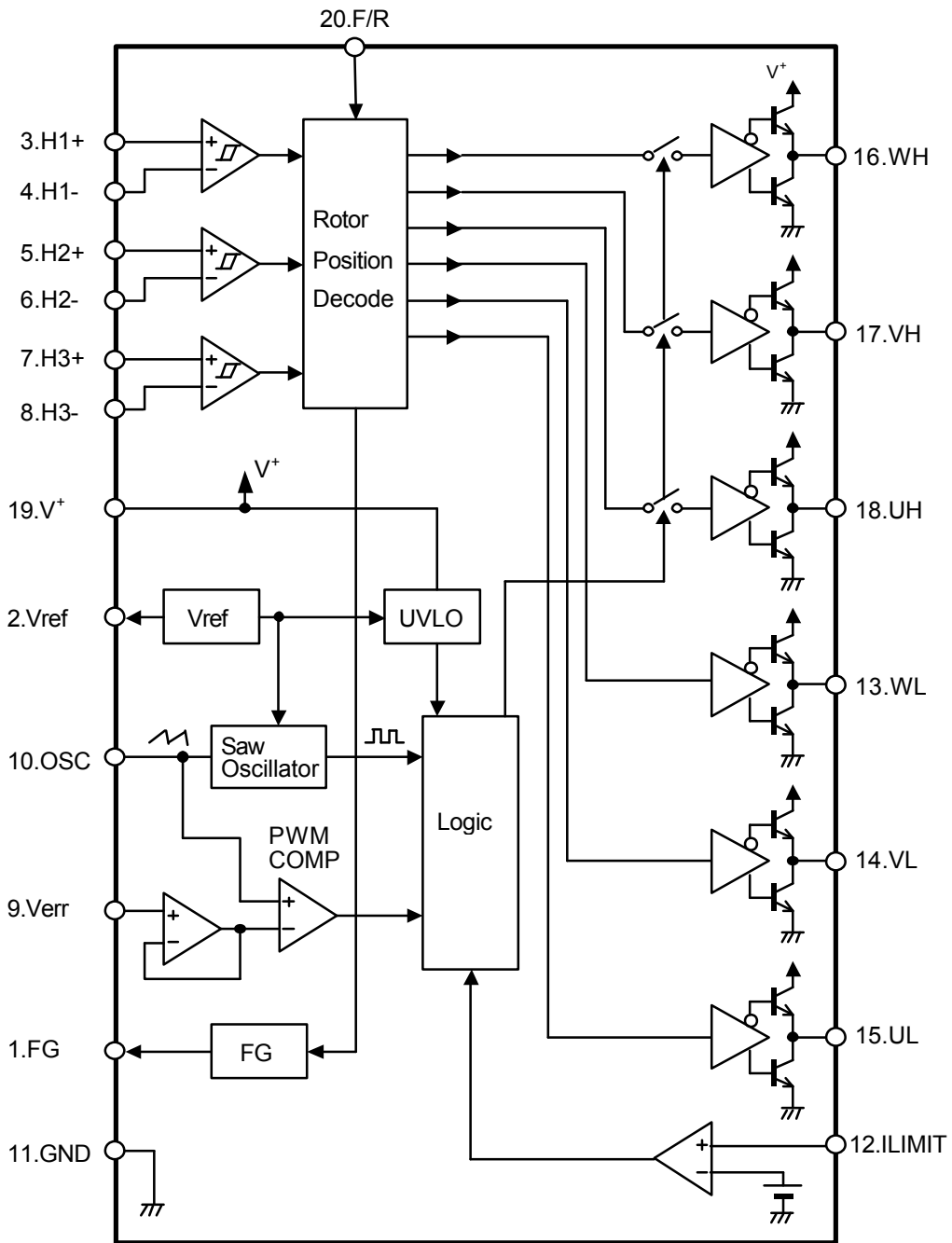

◆ ABSOLUTE MAXIMUM RATINGS (Ta=25°C)

| PARAMETER | SYMBOL | RATINGS | UNIT |
|-----------------------------|------------------|-------------|------|
| Maximum Supply Voltage | V ⁺ | 20 | V |
| Power Dissipation | P _D | (DMP20) 350 | mW |
| Operating Temperature Range | T _{opr} | -40 ~ +85 | °C |
| Storage Temperature Range | T _{stg} | -50 ~ +150 | °C |

◆ ELECTRICAL CHARACTERISTICS (V⁺=12V, C_t=1000pF, C_{ref}=1μF, Ta=25°C)

Total Device

| PARAMETER | SYMBOL | TEST CONDITIONS | MIN. | TYP. | MAX. | UNIT |
|---|-----------------|--|------|------|------|------|
| Supply Voltage | V ⁺ | | 8.0 | - | 18.0 | V |
| Under Voltage Sense Voltage (Under Voltage Lock Out) | UVLO | Output Enable V ⁺ Decreasing | 7.00 | 7.25 | 7.50 | V |
| Hysteresis Voltage (Under Voltage Lock Out) | ΔUVLO | | 0.4 | 0.5 | 0.6 | V |
| Supply Current | I _{cc} | R _L =∞ PWM Duty=50% | - | 15.0 | 22.0 | mA |

Hall Sensor Section

| PARAMETER | SYMBOL | TEST CONDITIONS | MIN. | TYP. | MAX. | UNIT |
|------------------------------------|------------------|----------------------|------|------|------|------|
| Hysteresis Voltage | V _{hys} | R _L =470Ω | - | 30 | - | mV |
| Input Common mode Voltage range | V _{icm} | R _L =470Ω | 1.5 | - | 10.5 | V |
| Input Bias Current | I _B | | - | - | 600 | nA |

Output Section

| PARAMETER | SYMBOL | TEST CONDITIONS | MIN. | TYP. | MAX. | UNIT |
|------------------|-----------------|---------------------------|------|------|------|------|
| Output Voltage 1 | V _{oh} | I _{source} =50mA | 10 | 10.3 | - | V |
| Output Voltage 2 | V _{ol} | I _{sink} =150mA | - | 1.5 | 2.0 | V |

Over Current Sense Section

| PARAMETER | SYMBOL | TEST CONDITIONS | MIN. | TYP. | MAX. | UNIT |
|---------------------|-----------------|-----------------|------|------|------|------|
| Sense Voltage | V _{th} | | 0.45 | 0.50 | 0.55 | V |
| Input Voltage Range | V _{ip} | | - | - | 3.0 | V |
| Input Bias Current | I _{IB} | | - | -0.9 | -5.0 | μA |

Oscillator Section

| PARAMETER | SYMBOL | TEST CONDITIONS | MIN. | TYP. | MAX. | UNIT |
|---|----------------------|---------------------------|------|------|------|------|
| Oscillation Frequency | f _{osc} | | 20 | 25 | 30 | kHz |
| Oscillate Fluctuations (Line Regulation) | f _{osc} / V | V ⁺ =8V to 18V | - | 0.01 | 5.00 | % |
| PWM0% Sense Voltage | PWM0 | PWM DUTY=0% | - | - | 0.35 | V |
| PWM100% Sense Voltage | PWM1 | PWM DUTY=100% | 5.40 | - | - | V |
| Saw Wave Peak Voltage | V _{pfosc} | | 4.75 | 5.00 | 5.25 | V |
| Saw Wave Bottom Voltage | V _{bfosc} | | 0.50 | 0.65 | 0.80 | V |

NJM2625A

◆ ELECTRICAL CHARACTERISTICS ($V^+=12V$, $C_t=1000pF$, $C_{ref}=1\mu F$, $T_a=25^\circ C$)

FG Output Section

| PARAMETER | SYMBOL | TEST CONDITIONS | MIN. | TYP. | MAX. | UNIT |
|--------------------|--------|-----------------|------|------|------|------------|
| Saturation Voltage | FGV | | - | 0.3 | 0.5 | V |
| Pull-Up Resistance | FGR | | 8 | 10 | 12 | k Ω |

Error Amplifier Section

| PARAMETER | SYMBOL | TEST CONDITIONS | MIN. | TYP. | MAX. | UNIT |
|---------------------------------|--------|-----------------|------|------|------|------|
| Input Offset Voltage | Vio | | - | 7 | - | mV |
| Input Offset Current | lio | | - | 8.0 | - | nA |
| Input Bias Current | librr | | - | -46 | - | nA |
| Input Common mode Voltage range | Vicmrr | | 0 | - | Vref | V |

Reference Voltage Section

| PARAMETER | SYMBOL | TEST CONDITIONS | MIN. | TYP. | MAX. | UNIT |
|-----------------|--------|----------------------|------|------|------|------|
| Output Voltage | Vref | Iref=1.0mA | 6.00 | 6.40 | 6.80 | V |
| Line Regulation | VrefLI | $V^+=8V$ to 18V | - | 1.5 | 25 | mV |
| Road Regulation | VrefLO | Iref=1.0mA to 20.0mA | - | 150 | 250 | mV |

Forward or Reverse Direction Section

| PARAMETER | SYMBOL | TEST CONDITIONS | MIN. | TYP. | MAX. | UNIT |
|--------------------|--------|-----------------|---------|------|-------|------|
| Forward Direction | VF | RL=470 Ω | V^+-2 | - | V^+ | V |
| Reverse Direction | VR | RL=470 Ω | - | - | 2 | V |
| Hysteresis Voltage | VFR | RL=470 Ω | - | 0.5 | - | V |

(note) Output switch tests are performed under pulsed conditions to minimize power dissipation.

◆ FG Output

| | Input | | | FG Output |
|---|-------|----|----|-----------|
| | H1 | H2 | H3 | |
| 1 | H | L | H | H |
| 2 | H | L | L | L |
| 3 | H | H | L | H |
| 4 | L | H | L | L |
| 5 | L | H | H | H |
| 6 | L | L | H | L |

◆ F/R Input Pin

This pin dose not include neither pull up resistance nor pull down resistance.

| Terminal Voltage | Direction |
|------------------|-----------|
| L input | F |
| H input | R |

◆ TYPICAL APPLICATION

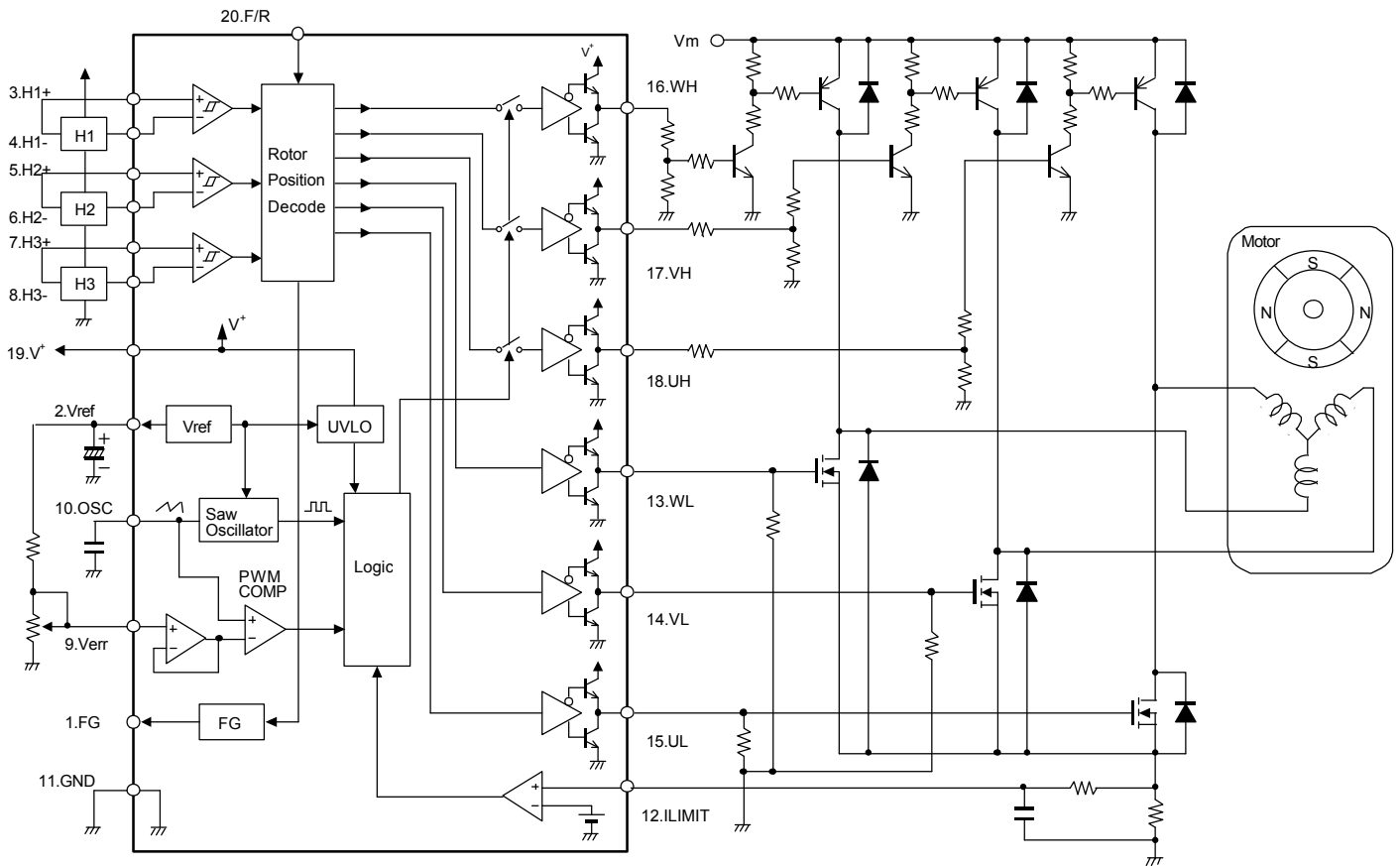

- A rotation direction change must be made after motor stopped completely.
- When PWM duty is extremely small, two or more switching elements cannot be driven entirely. In such case, switching elements will generate excess heat and it may cause destruction of the switching devices. Therefore, extensive heat evaluation is necessary for switching device selection particularly in consideration of the area of safety operation (ASO).

NJM2625A

◆ TYPICAL CHARACTERISTICS

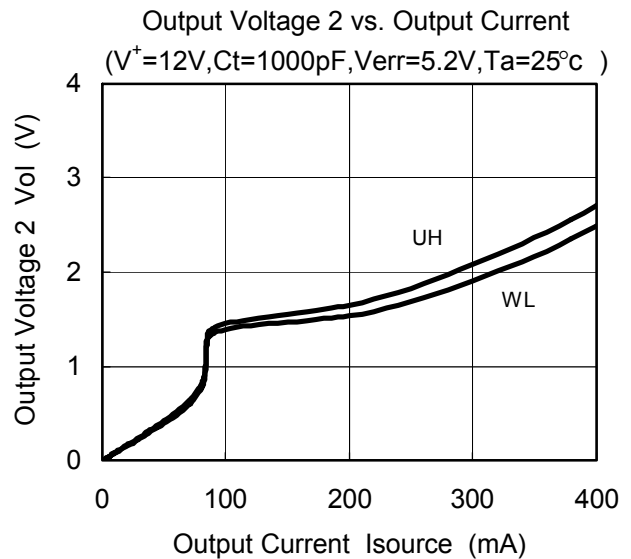
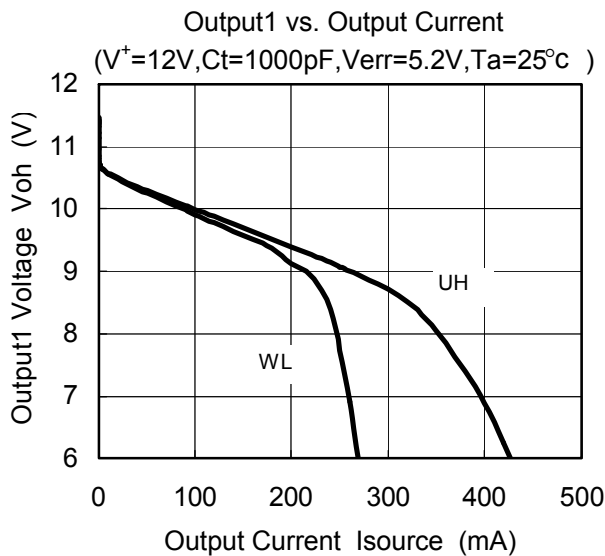
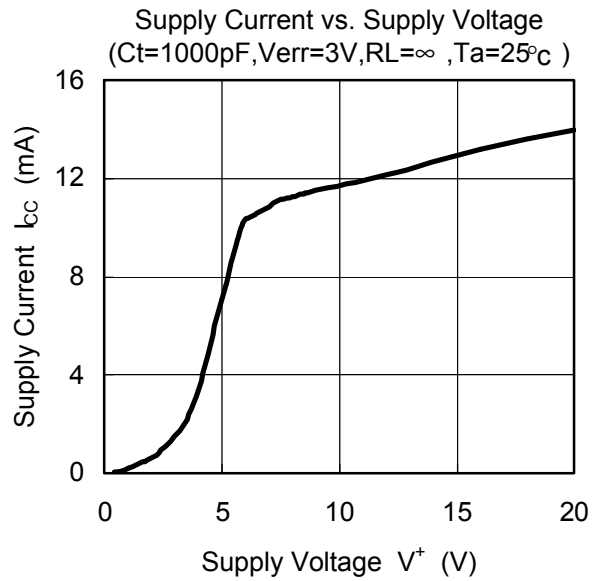
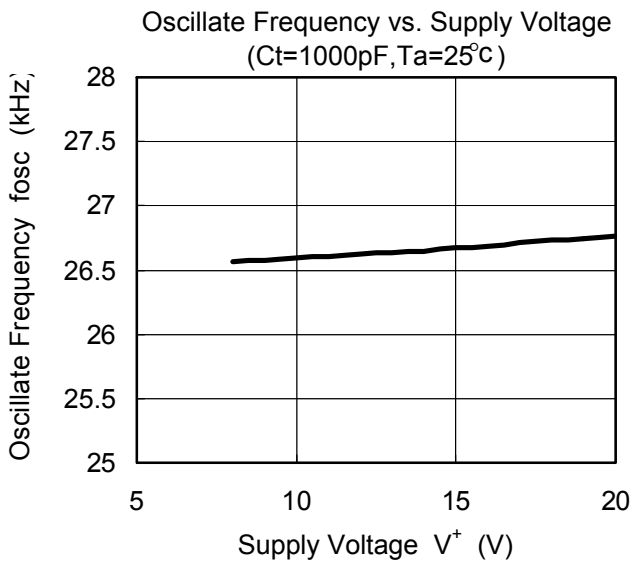
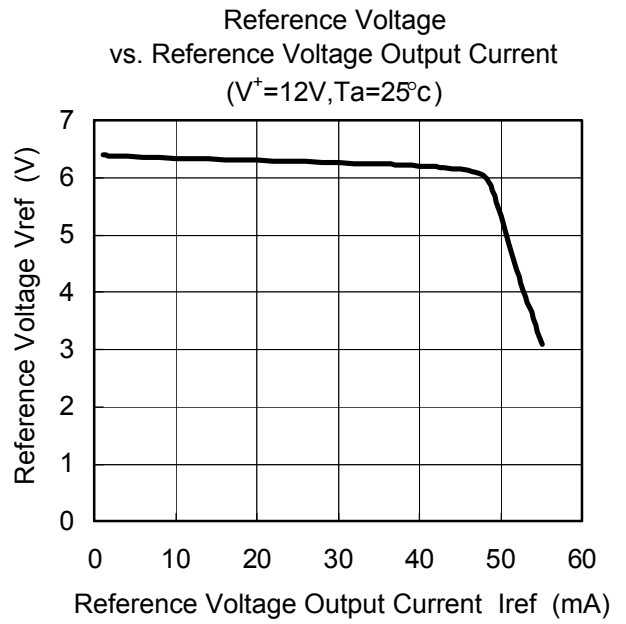
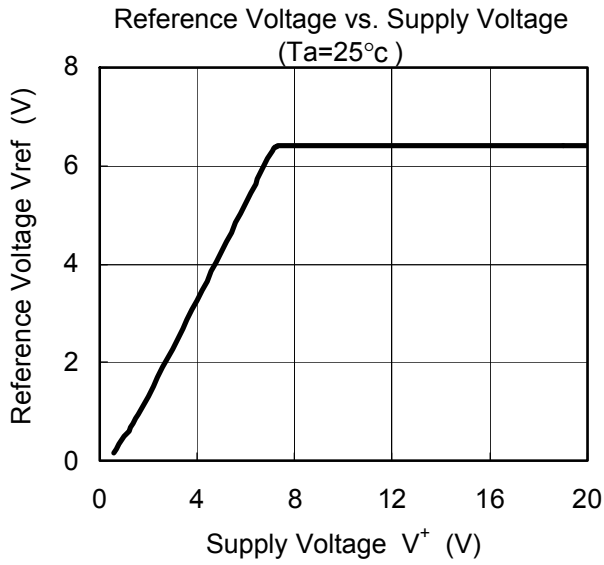

■ TYPICAL CHARACTERISTICS

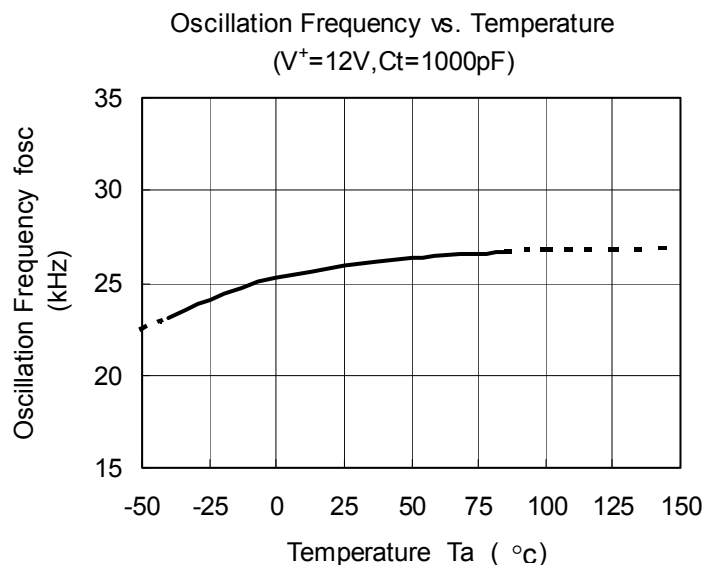
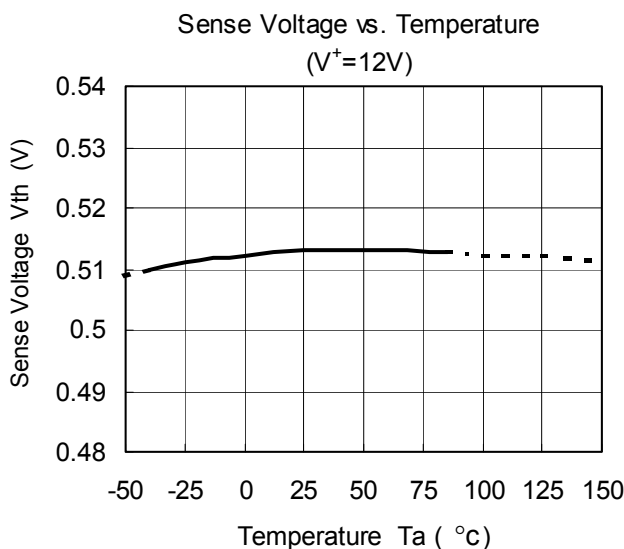
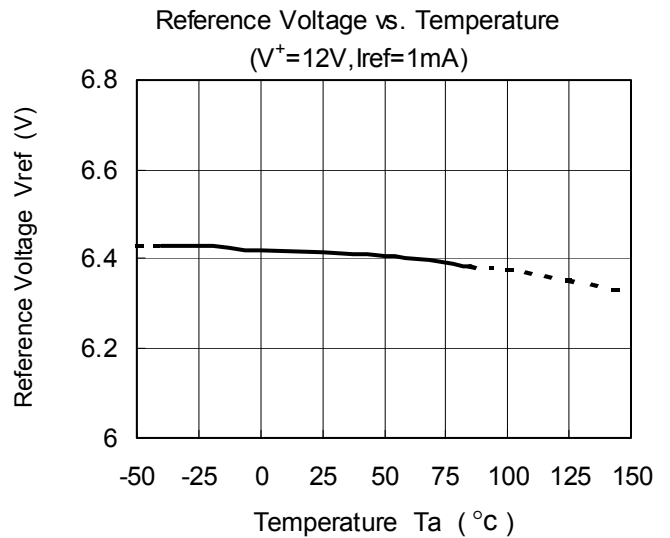
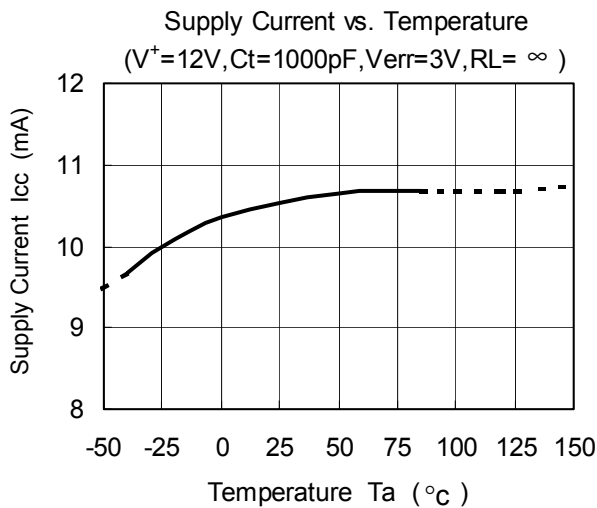
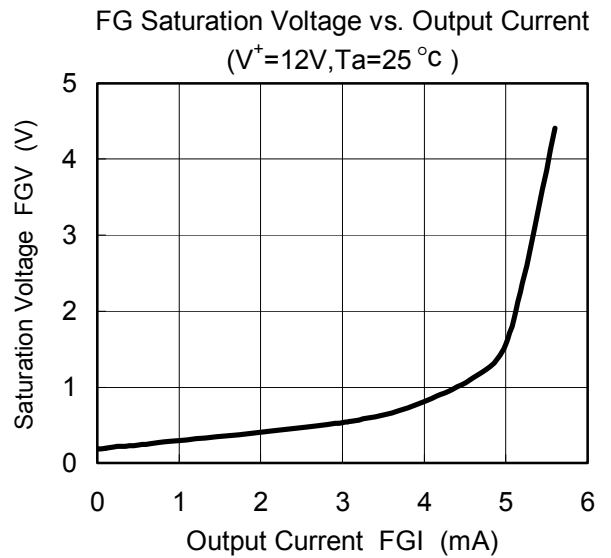
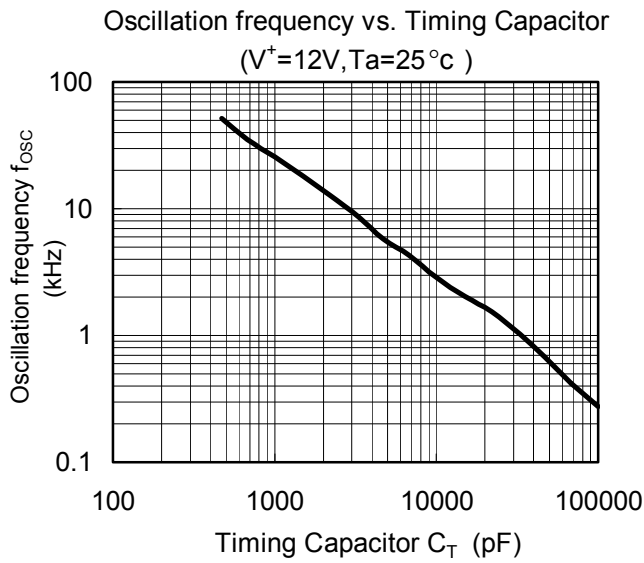

NJM2625A

MEMO

The specifications on this data book are only given for information, without any guarantee as regards either mistakes or omissions. The application circuit in this data book are described only to show representative usages of the product and not intended for the guarantee or permission of any right including the industrial rights.

Mouser Electronics

Authorized Distributor

Click to View Pricing, Inventory, Delivery & Lifecycle Information:

[NJR:](#)

[NJM2625BM-TE1](#) [NJM2625AM](#) [NJM2625AM-TE1](#) [NJM2625BM](#)



Стандарт Электрон Связь

Мы молодая и активно развивающаяся компания в области поставок электронных компонентов. Мы поставляем электронные компоненты отечественного и импортного производства напрямую от производителей и с крупнейших складов мира.

Благодаря сотрудничеству с мировыми поставщиками мы осуществляем комплексные и плановые поставки широчайшего спектра электронных компонентов.

Собственная эффективная логистика и склад в обеспечивает надежную поставку продукции в точно указанные сроки по всей России.

Мы осуществляем техническую поддержку нашим клиентам и предпродажную проверку качества продукции. На все поставляемые продукты мы предоставляем гарантию .

Осуществляем поставки продукции под контролем ВП МО РФ на предприятия военно-промышленного комплекса России , а также работаем в рамках 275 ФЗ с открытием отдельных счетов в уполномоченном банке. Система менеджмента качества компании соответствует требованиям ГОСТ ISO 9001.

Минимальные сроки поставки, гибкие цены, неограниченный ассортимент и индивидуальный подход к клиентам являются основой для выстраивания долгосрочного и эффективного сотрудничества с предприятиями радиоэлектронной промышленности, предприятиями ВПК и научно-исследовательскими институтами России.

С нами вы становитесь еще успешнее!

Наши контакты:

Телефон: +7 812 627 14 35

Электронная почта: sales@st-electron.ru

Адрес: 198099, Санкт-Петербург,
Промышленная ул, дом № 19, литера Н,
помещение 100-Н Офис 331