

Thank you for requesting Intersil's high-performance TMDs signal multiplexor/regenerator/retimer evaluation kit. This document contains all information needed to successfully install software and control the evaluation hardware.

Windows® is a registered trademark of Microsoft Corporation.

HDMI™ is a trademark of HDMI Licensing, LLC

PC Requirements

The software works best with Microsoft Windows 2000 or XP, and requires a minimum of 6MB free RAM, 5MB free hard disk space, and a USB (1.1 or higher) port.

Included Files and Hardware

- Evaluation Board (either ISL54100A or ISL54105A)
- Datasheet (PDF format)
- Schematic (PDF format)
- Layout (PDF format)
- "ISL5410xA.exe" software installer ("x" can be "0" or "5")
- USB type-A to type-B Cable
- Power Supply: AC adapter to 5V_{DC} converter

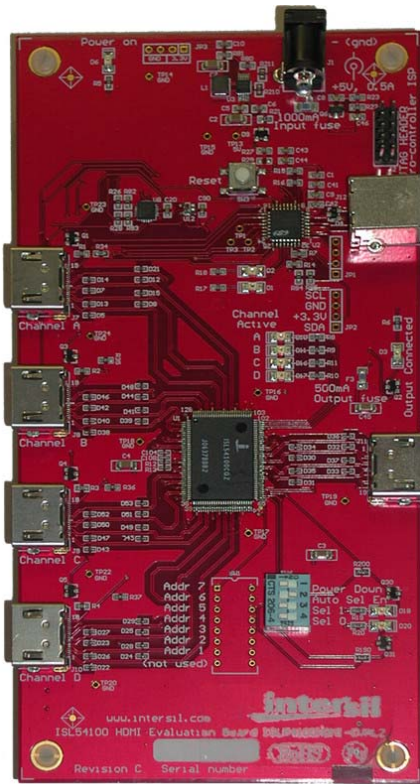

**ISL54100A (4→1)
ISL54100AHDMI-EVALZ**

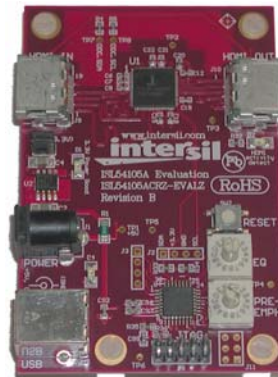

**ISL54105A (1→1)
ISL54105ACRZ-EVALZ**

Table of Contents

Definitions 3

Evaluation Software Installation 3

Connecting the Evaluation Board 4

Evaluation Kit Operation 5

 Hardware Setup 5

 ISL5410xA Register Defaults 5

 Hardware Operation 6

 ISL54100A 6

 ISL54105A 7

 Software Operation 7

 ISL54100A-only Software Features 8

 ISL54105A-only Software Features 8

 Display Issues 8

 ISL54101A/ISL54102A 8

HDMI Control Signals (DDC, HPD, and CEC) 9

Troubleshooting 9

 Software Issues 9

 USB Port 9

 USB Driver Installation 10

 Hardware Issues 10

 Notes 10

ISL54100AHDMI-EVALZ Schematics 11

ISL54105ACRZ-EVALZ Schematics 14

ISL54100HDMI-EVALZ BILL OF MATERIALS 16

ISL54105ACRZ-EVALZ BILL OF MATERIALS 19

ISL54100AHDMI-EVALZ Layout 21

ISL54105ACRZ-EVALZ Layout 28

Definitions

PC

Inter-Integrated Circuit – A two-wire serial communications bus designed by Philips Semiconductors. I²C is a multi-master bus, which means that multiple chips can connect to the same bus and each one can act as a master by initiating a data transfer. Many devices use I²C, especially video devices such as computer monitors, televisions, and VCRs.

DDC

Display Data Channel – A VESA standard for I²C communication between a monitor and a video adapter. Using DDC, a monitor (the “sink”) can inform a video card (the “source”) about its properties, such as maximum resolution and color depth. The video card can then use this information to present valid options to the user configuring the display.

TMDS

Transition Minimized Differential Signaling – A high-speed (Gbit/s) data transmission scheme used by HDMI. At the electrical level TMDS uses CML¹ with two 50Ω terminations to 3.3V. At the data level TMDS has a custom 8b/10b data encoding scheme to maintain DC-balance.

HDMI

High Definition Multimedia Interface – HDMI is a collection of physical connector (cable) standards, electrical standards, and data (protocol) standards. Together, these provide a medium for securely transmitting digital audiovisual data from a source (DVD Player) to a sink (HDTV).

GUI

Graphical User Interface – A software interface which is graphical and presents the user with visual options for program control; the counter is the command line.

HPD

Hot Plug Detect – Modern display standards make use of an “HPD” pin that allows two devices to sense an interconnection. When an HDMI cable is first connected, the sink (display) will sense 5V power from the source (computer/DVD player), and the sink will drive its HPD pin high to let the source know it is ready for video information.

USB

Universal Serial Bus – A serial bus and cabling standard to interface devices and PCs.

Evaluation Software Installation

Launch the Installation Setup Wizard (the file ending in “.exe”) included with this evaluation kit and follow the instructions. Upon completion, a shortcut to the program can then be activated from the Windows Start Menu under *Start→All Programs→Intersil*. The main program files will be installed in the *C:\Program Files\Intersil* directory. The USB driver file *windrvr6.sys* will be placed into *C:\WINDOWS\system32\drivers* and an INF file will be installed under *C:\WINDOWS\INF*.

The instructions shown in the captions below demonstrate a typical installation (ISL54105 eval software shown, other boards’ installations are essentially identical).

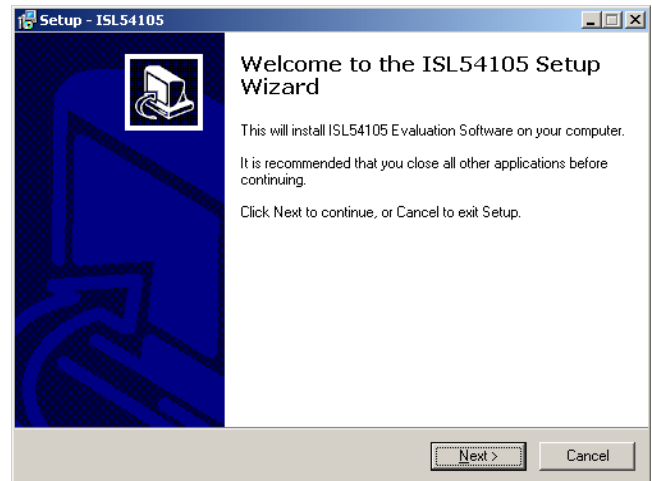

FIGURE 1. PRESS “NEXT” TO CONTINUE

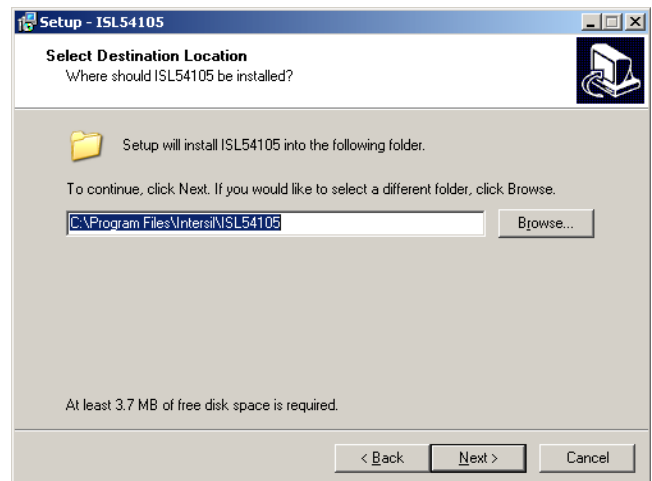

FIGURE 2. BY DEFAULT, THE INSTALLER WILL PUT THE EVAL SOFTWARE UNDER “C:\PROGRAM FILES\INTERASIL”. PRESS “NEXT” TO CONTINUE.

1. http://en.wikipedia.org/wiki/Current_mode_logic

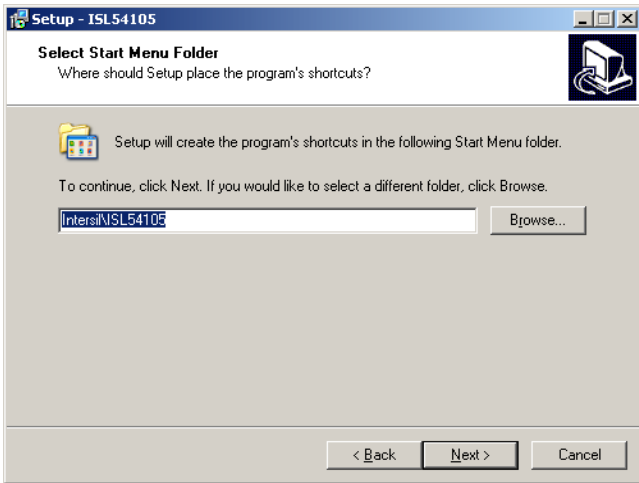

FIGURE 3. PRESS "NEXT" TO CREATE THE INTERSIL FOLDER IN THE START MENU



FIGURE 5. SELECT "YES, NOW AND EVERY TIME..." AND CLICK "NEXT"

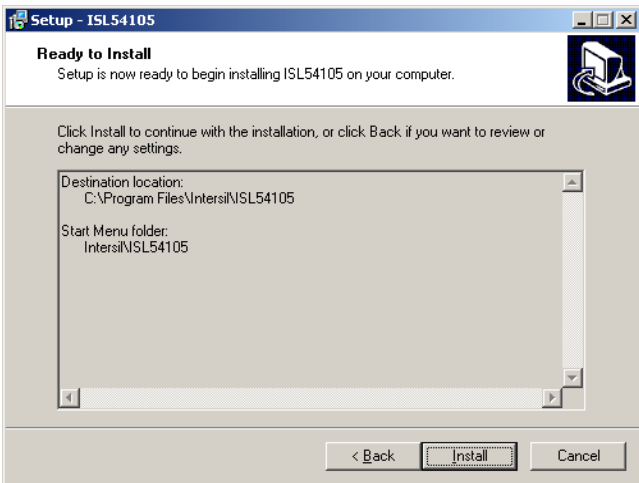

FIGURE 4. PRESS THE "INSTALL" BUTTON TO COPY ALL THE NECESSARY FILES ONTO THE PC



FIGURE 6. ENSURE THE RECOMMENDED OPTION IS SELECTED AND PRESS "NEXT"

Connecting the Evaluation Board

After installation of the evaluation software, reboot the PC if requested. Apply power to the evaluation board using the provided 5V power supply. Connect the USB cable to the evaluation board. The Microsoft Windows operating system will see the evaluation board as a new device, and will try to load an appropriate driver for it.

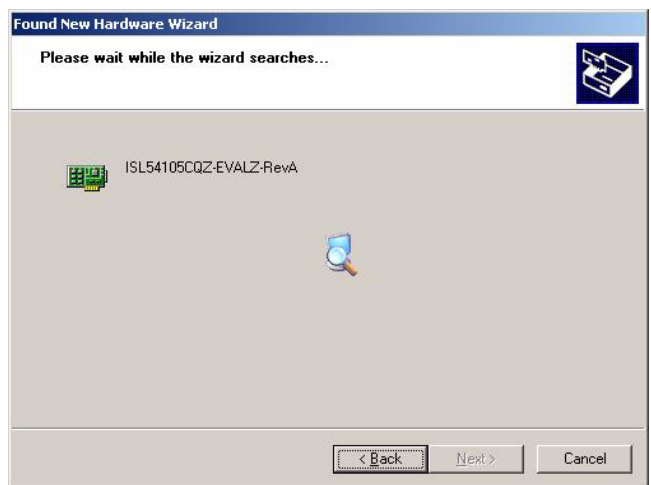

FIGURE 7. THE HARDWARE WIZARD WILL LOCATE AND INSTALL THE ISL5410xA DRIVERS



FIGURE 8. DONE! CLICK "FINISH" TO CLOSE THE WIZARD

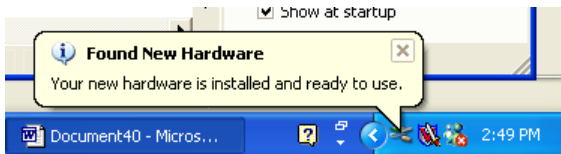

FIGURE 9. ON XP SYSTEMS, A POP-UP MESSAGE MAY DISPLAY THE CONNECTION STATUS OF THE ISL5410xA HARDWARE

Evaluation Kit Operation

Hardware Setup

Please follow the steps below in order to make use of our evaluation board.

Plug the power supply into the wall, and connect the 5V connector to the board's power jack. Connect a DVI/HDMI video sink (monitor, HDTV, etc) to the output connector. Connect a DVI/HDMI video source (PC, DVD player, etc) to the input connector.

ISL5410xA Register Defaults

The ISL54100A and ISL54105A datasheets mention "recommended default" values. Intersil has programmed the evaluation board's microcontroller to overwrite two of the silicon default values: the PLL bandwidth bits (register 0x10 bits [1:0]) and clock hysteresis bits (register 0x03 bits [6:5])

When the PLL bandwidth is set lower, the ISL5410xA will reject more high-band jitter. High-band jitter present on TMDS lines can make it difficult for HDTVs/monitors to track the input signal, and this effect is most noticeable for high-datarate signals over long cables.

The ISL5410xA detects activity in one of two ways: common mode detection or hysteresis detection. Common mode activity detection is less robust, since it only looks at the DC voltage level on the clock pin. Hysteresis detection mode looks for *movement* on the clock pin.

Write "0x10" to Channel Selection register 0x02 to reset our TMDS regenerator to its silicon-default values.

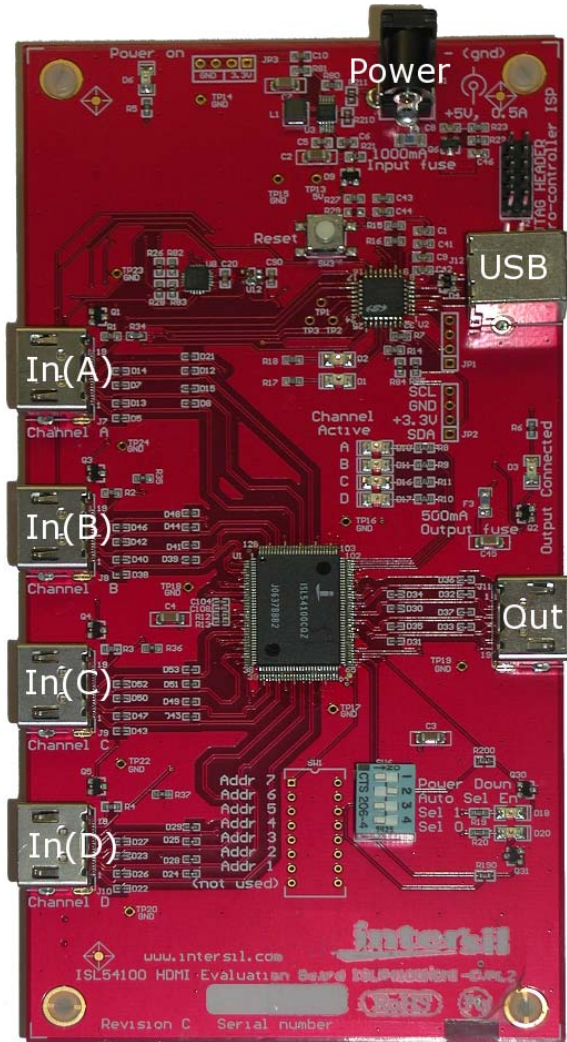

FIGURE 10. ISL54100AHDMI-EVALZ BOARD WITH PORT LABEL

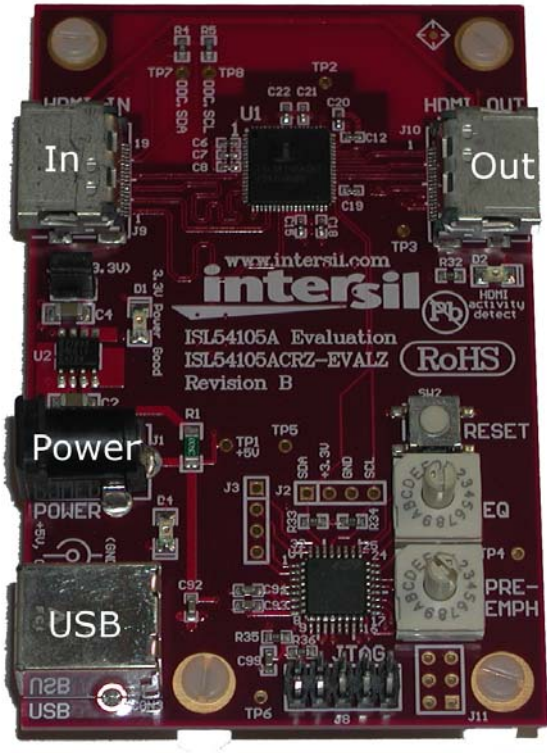

FIGURE 11. ISL54105ACRZ-EVALZ BOARD WITH PORT LABELS

Hardware Operation

The ISL54100A board and ISL54105A board have different hardware controls as shown in Figure 12.

ISL54100A

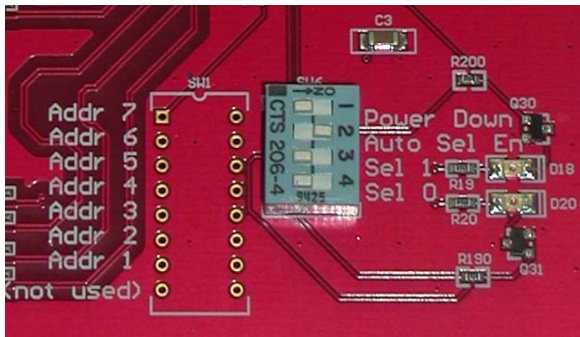

FIGURE 12. ISL54100A DIP SWITCHES IN THE "AUTO-SELECT" POSITION

Figure 12 shows four switches which can put the ISL54100A into a variety of states (detailed in Tables 1 and 2). The Addr pins can be used to change the ISL54100A's I²C device address. Designs which have multiple ISL54100As connected to the same I²C bus need to give each device a different I²C address.

TABLE 1. POWER DOWN AND AUTO SEL EN DESCRIPTION

SWITCH LABEL	"ON" STATE	"OFF" STATE
Power Down	Minimal power consumption mode; TMDS lines are open-circuited	Normal operation
Auto Sel En	Ignore Sel 1 and Sel 0. Select first port with active clock (try A, B, C, D)	Select port according to state of Sel 0 and Sel 1

TABLE 2. SEL 0 AND SEL 1 SWITCH DESCRIPTION

SWITCH STATE		SELECTED PORT
SEL 1	SEL 0	
Off	Off	Port A
Off	On	Port B
On	Off	Port C
On	On	Port D

Note that a hardware channel selection (Sel 0 and Sel 1) can be overridden by an I²C software channel select command.

The evaluation boards are designed to indicate the ISL5410xA's state of operation. In the event of hardware issues, these LEDs may help the user locate any problems.

TABLE 3. ISL54100A BOARD LED DESCRIPTION

LED DESIGNATOR	"ON" STATE DESCRIPTION
D1	3.3V rail is low
D2	Flashes during μ C reset
D3	Sink (output) device connected
D6	3.3V rail detected
D10	Active clock on Port A
D11	Active clock on Port B
D16	Active clock on Port C
D17	Active clock on Port D
D18	CH_SEL_1 high
D20	CH_SEL_0 low

TABLE 4. RELATIONSHIP BETWEEN ROTARY SWITCH POSITION AND REGISTER SETTING

SWITCH POSITION	"0"	"1"	"2"	"3"	"4"	"5"	"6"	"7"	"8"	"9"	"A"	"B"	"C"	"D"	"E"	"F"
REGISTER BITS	0000	0001	0010	0011	0100	0101	0110	0111	1000	1001	1010	1011	1100	1101	1110	1111

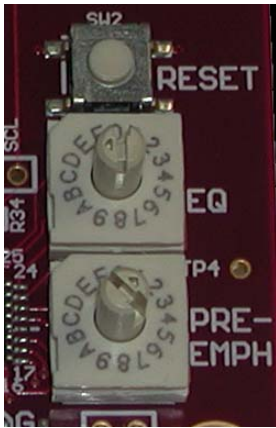

FIGURE 13. ISL54105A ROTARY SWITCHES AND RESET BUTTON

Figure 13 shows the *Equalization* switch and *Preemphasis* switch which adjust the input and output gains of the ISL54100A. The equalization bits (register 0x08 bits [3:0]) control the gain applied to the incoming signal. The preemphasis bits (register 0x06 bits [7:4]) increase the high-frequency content of the output signal². For both switches, “F” represents the maximum and “0” the minimum.

Note that if the rotary switches are turned, the other nibble of that register is reset to 0x0, and will need to be reprogrammed as required using the input boxes on the GUI.

TABLE 5. ISL54105A BOARD LED DESCRIPTION

LED DESIGNATOR	"ON" STATE DESCRIPTION
D1	3.3V rail detected
D2	Active clock on input
D4	Flashes during μ C reset

Software Operation

The user can launch the software from either the Start Menu, or from the user-specified installation path on the hard drive. Once launched, the user will see one of the following screens:

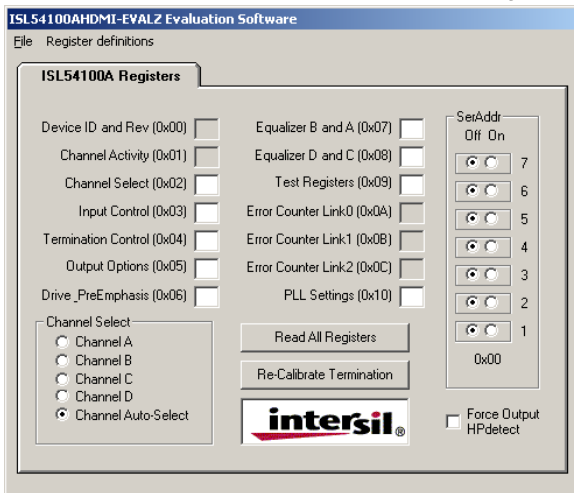

FIGURE 14. ISL54100A SOFTWARE GUI

2. Preemphasis (high frequency boost) is used to partially offset the high frequency attenuation of long cables.

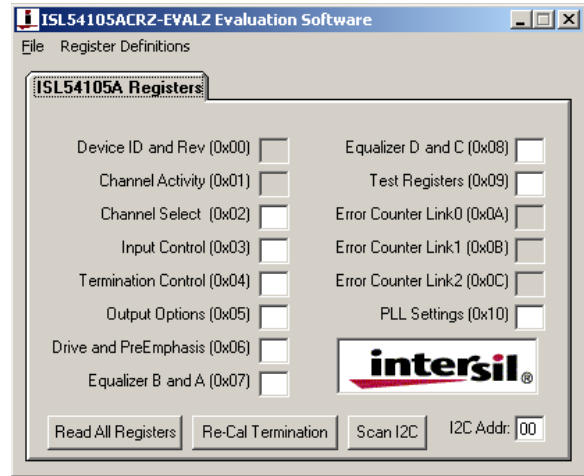

FIGURE 15. ISL54105A SOFTWARE GUI

Note that the grayed-out registers are *read-only* (0x00, 0x01, 0x0A, 0x0B, and 0x0C).

Click on the “Read All Registers” button and the ISL5410xA register values should populate across every field (Figure 17). The “Re-Calibrate Termination” button forces the ISL5410xA to manually recalibrate the TMDs termination impedances (see register 0x03 bit 7).

If the register values come back as all “0” (Figure 16), verify that the I²C address is set to match the board. The I²C address is set through the “SerAddr” box in the ISL54100A GUI or “I²C Addr” field in the ISL54105A GUI.

If the I²C address is correct for the board and the software is still not able to read the registers, please proceed to “Troubleshooting” on page 9 of this document.

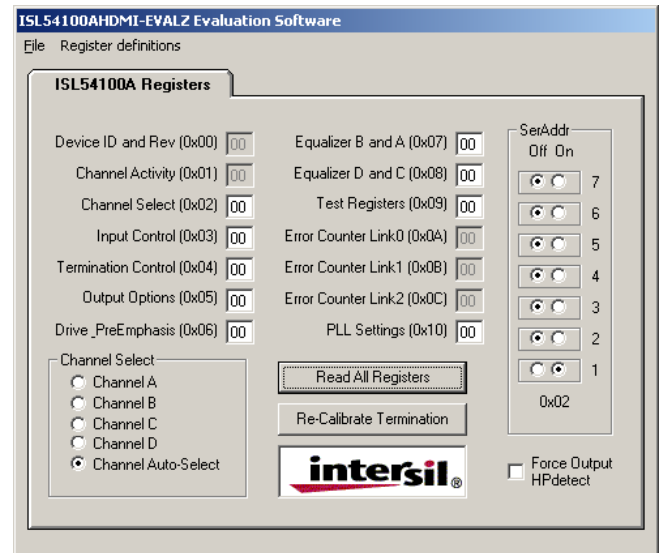

FIGURE 16. RESULT OF A REGISTER READ WHEN DEVICE I²C ADDRESS IS SET INCORRECTLY

To change a register value, simply select one or both nibbles³ of the desired register and type the new number.

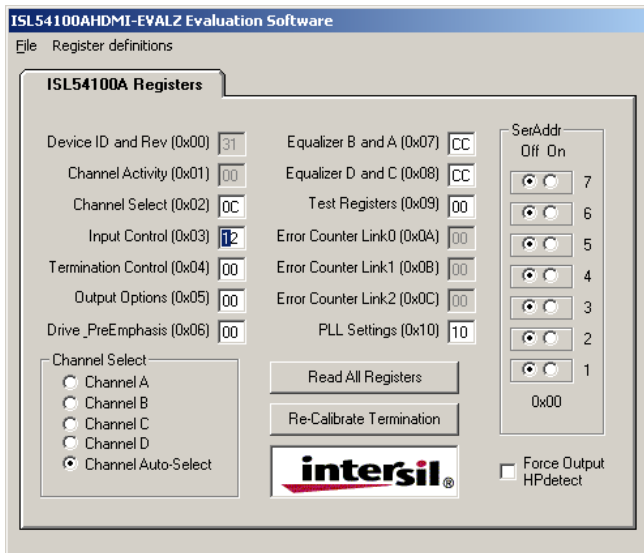

FIGURE 17. REGISTERS HAVE BEEN READ; NOW CHANGING THE UPPER NIBBLE OF REGISTER 0x03

Should the user desire to change both upper/lower nibbles in a register, it is important to type both digits in *under a second*. The software is written to automatically read back any changes, so a slow typist may only get one value in before that register is automatically read back, causing unintended values to be written.

Some shortcuts for changing the selected register's value are:

- Up Arrow – Increment by 1
- Down Arrow – Decrement by 1
- Page Up – Increment by 16 (increment high nibble by 1)
- Page Down – Decrement by 16 (decrement high nibble by 1)

The user can find a complete listing of register bits in the datasheet, or in the “register definitions” drop-down menu as shown in Figure 18.

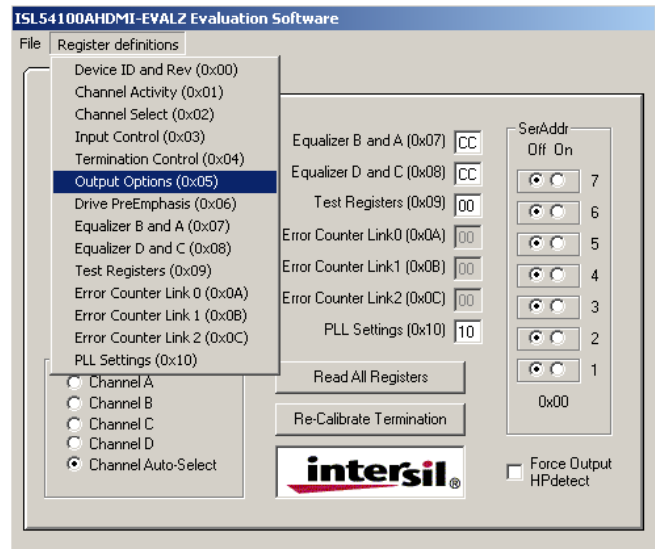

FIGURE 18. “REGISTER DEFINITIONS” DROP-DOWN MENU

ISL54100A-ONLY SOFTWARE FEATURES

The ISL54100A board has multiple input HDMI ports, so the “Channel Select” box in the lower left region of the GUI will modify the IC’s channel select setting (register 0x02 bits [1:0]). Remember that software-control *overrides* the state of the hardware channel select pins.

The software contains the option to force the output HPD pin high (“Force Output HPdetect”). This pin is normally driven by the device connected to the board’s output port (the sink). Manual control of the HPD pin may be useful for experimentation and debugging purposes.

ISL54105A-ONLY SOFTWARE FEATURES

The ISL54105A software has a box labeled “Scan I²C”. When clicked, the ISL54105A software will try every I²C address from 0x00 to 0x7F (0 to 127) and stop when a response is found for a particular address. This allows users to connect the evaluation board’s I²C lines (*SDA*, *SCL*, *GND*) to a different board’s I²C lines and quickly find the new board’s ISL54105A’s I²C address.

Display Issues

In the event that a display or monitor does not show any image, please verify the board’s settings and proceed to “Troubleshooting” on page 9 of this document.

ISL54101A/ISL54102A

The fundamental pinout is the same across all regenerators using the QFP128 package.

Since the ISL54102A is a 2:1 regenerator, it has input/status pins for ports A and B only. The 1:1 regenerator ISL54101A has input/status pins for port A only.

3. A nibble is four bits, or half of one byte. 0xF2 has two nibbles, 0xF = 0b1111 and 0x2 = 0b0010.

HDMI Control Signals (DDC, HPD, and CEC)

The ISL54105A and ISL54100A boards handle the DDC, HPD, and CEC control signals differently. The ISL54105A board's control signals are wired directly from the input to the output since it is a 1:1 design. The ISL54100A design has to multiplex these control signals as well as the TMDS signals as shown in Figure 20.

The logic for HPD/DDC multiplexing is shown in Figure 19.

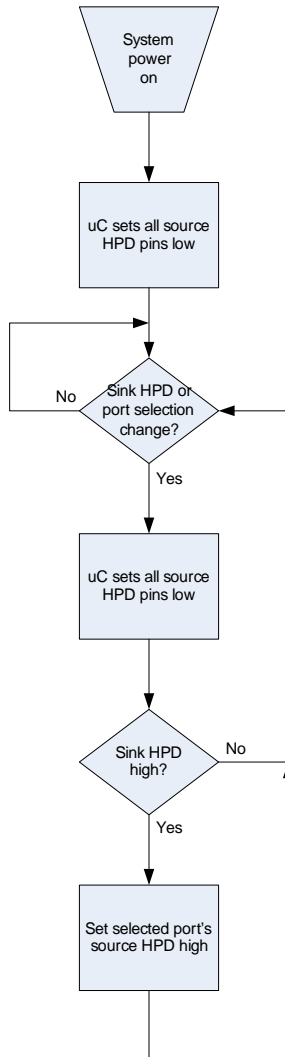

FIGURE 19. LOGIC FLOW CHART FOR MUXING HDMI CONTROL SIGNALS

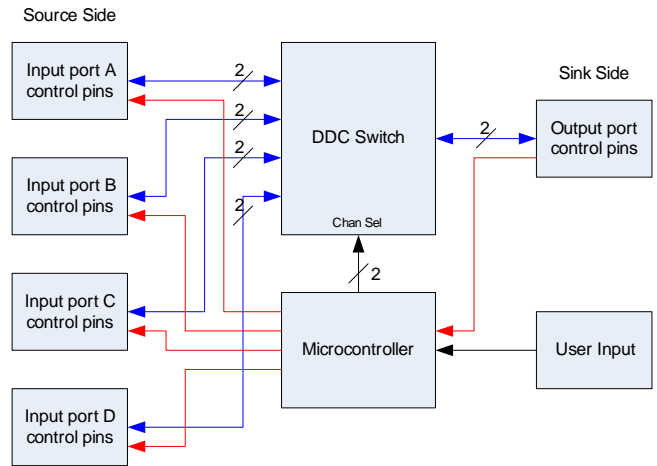

FIGURE 20. INTERCONNECTIONS BETWEEN DDC (BLUE), HPD (RED), DDC SWITCH, AND A μ C

The CEC signal is a serial communications bus for all connected devices, and all CEC signals are shorted together. See the HDMI spec for more information.

Troubleshooting

Software Issues

USB PORT

The software should be able to communicate with the evaluation board as soon as it is launched. If there is a communication problem, the following dialog box should be displayed:



FIGURE 21. ERROR DETECTING USB CONNECTION TO EVALUATION BOARD

If this dialog is present, open the Windows Control Panel. Double-click on the "System" icon and select the "Hardware" tab, then click on Device Manager. The screen shown in Figure 22 should now be present.

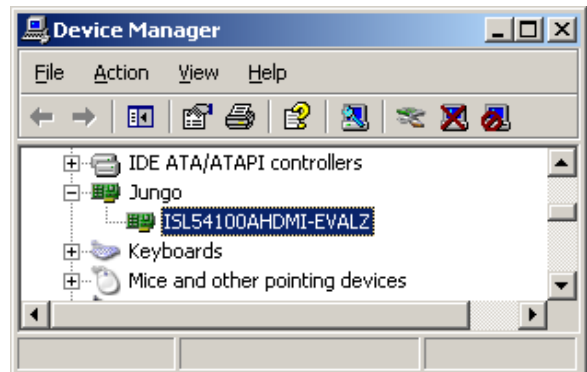

FIGURE 22. WINDOWS DEVICE MANAGER SHOWING EVALUATION BOARD USB DRIVERS

There should be a “Jungo” entry, with an item for Intersil’s evaluation board. This indicates the driver is properly installed and is communicating with the evaluation board. If this is not visible, or there are any error messages, take the following actions:

- Verify that the evaluation board has power and the USB cable connects between the evaluation board and the PC
- Disconnect the USB cable and then reconnect the USB cable between the evaluation board and PC
- Close all instances of the ISL5410xA application and restart the software

If none of this works, try rebooting, and then try installing the software on a different PC to verify correct operation of the evaluation board and software.

USB DRIVER INSTALLATION

After rebooting the PC, please verify that the following files are in the following locations for the ISL54105A board:

- windrvr6.sys in C:\WINDOWS\system32\Drivers
- ISL54105ACQZ-EVALZ.inf in C:\WINDOWS\INF
- ISL54105A_HDMI.exe in C:\Program Files\ISL54105A

...or for the ISL54100A board:

- windrvr6.sys in C:\WINDOWS\system32\Driver
- ISL54100AHDMI-EVALZ.inf in C:\WINDOWS\INF
- ISL54100A_HDMI.exe in C:\Program Files\ISL54100A

Hardware Issues

If the USB connection is functioning, but the DVI/HDMI monitor does not display an image, take the following steps:

- Hook the source directly to the sink, bypassing the ISL5410xA. If no image is displayed, resolve that problem before reinserting the ISL5410xA.
- Try changing the video resolution on the source to 480p or 800x600 pixels. Some HDTVs can not accept resolutions

common to PCs (1600x1200), and some monitors can not accept resolutions common to DVD players (1080p).

- Ensure the correct ISL54100A input is selected.
- Ensure the correct monitor/HDTV input is selected.
- Check to see if input and output connections are reversed
- Close the software and reset the μ C with the push-button switch.
- Use a voltmeter to verify the board is receiving a logic-high HPD signal from the video sink.
- Check to see the “3.3V present” LEDs are lit (see Tables 3 and 5) and check the 3.3V rail with a voltmeter.

If the power cord is plugged into the board and connected to the wall, and the “power good” LEDs are *not* lit, check to see if the ISL54100A’s fuse has blown (see *F4* – next to the input power connector).

If the fuse is blown or the board is otherwise not functioning as expected, please contact your distributor or local Intersil Sales Office for further assistance.

Notes

1. Using the PRE-EMPH rotary switch to modify the pre-emphasis will clear the contents of the “Transmit Current” (register 0x06[4:0]) nibble. Since the default transmit current is the standard 10mA, this is rarely a problem. If a transmit current higher than 10mA is desired, it must be programmed via the I²C/USB interface.
2. The hardware RESET button resets both the USB microcontroller and the ISL54105A. Resetting the microcontroller will disrupt the USB connection to the PC. Fortunately a hardware reset is never needed in normal operation - both the ISL54105A and the microcontroller should power on working correctly and stay in that state until power is removed. However, if the RESET button is pressed and communication is lost, simply closing and restarting the evaluation software should restore communication.

ISL54100AHDMI-EVALZ Schematics (Continued)

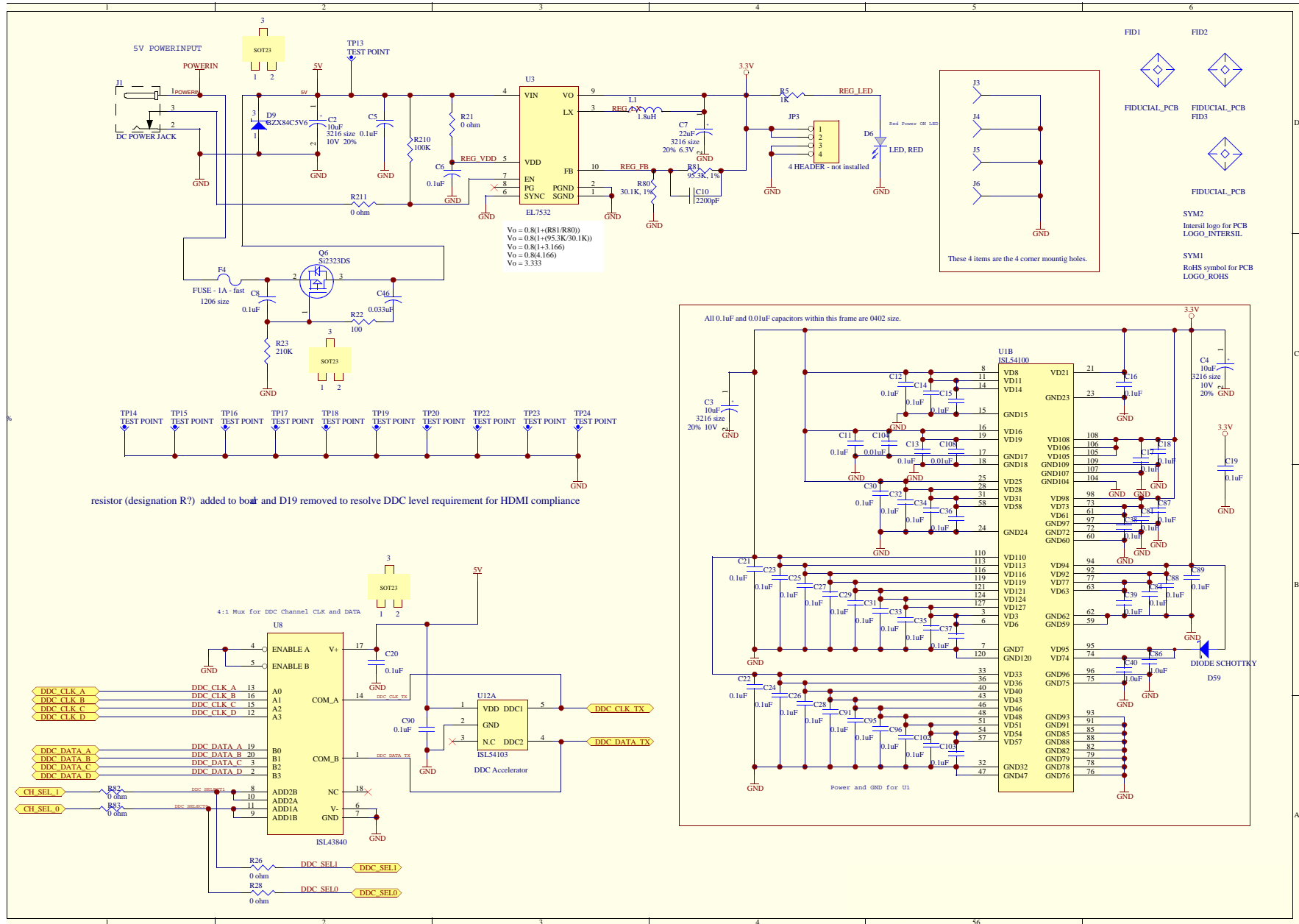

FIGURE 24. ISL54100AHDMI-EVALZ POWER/DDC

ISL54100AHDMI-EVALZ Schematics (Continued)

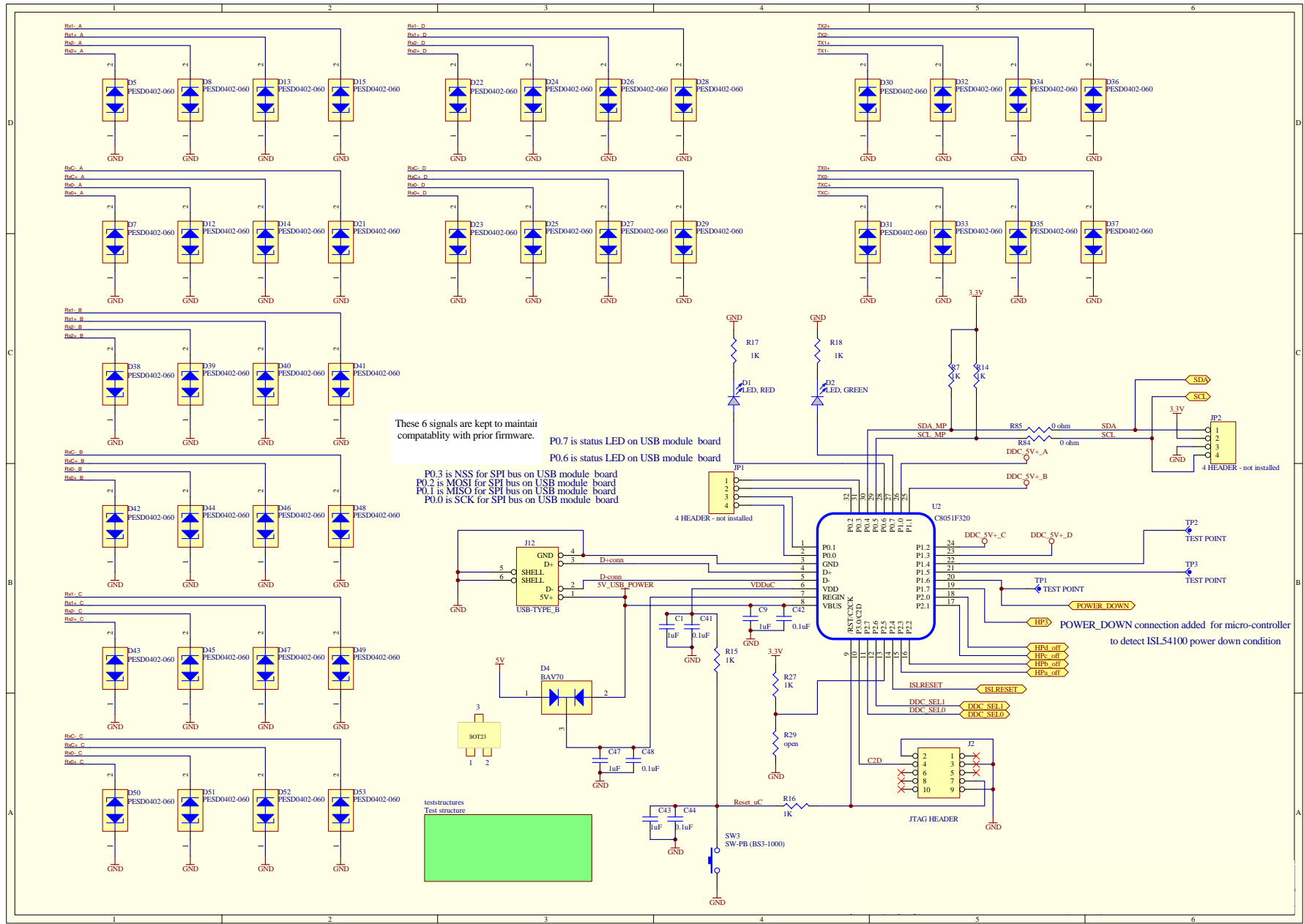

FIGURE 25. ISL54100AHDMI-EVALZ ESD/MICROCONTROLLER

ISL54105ACRZ-EVALZ Schematics

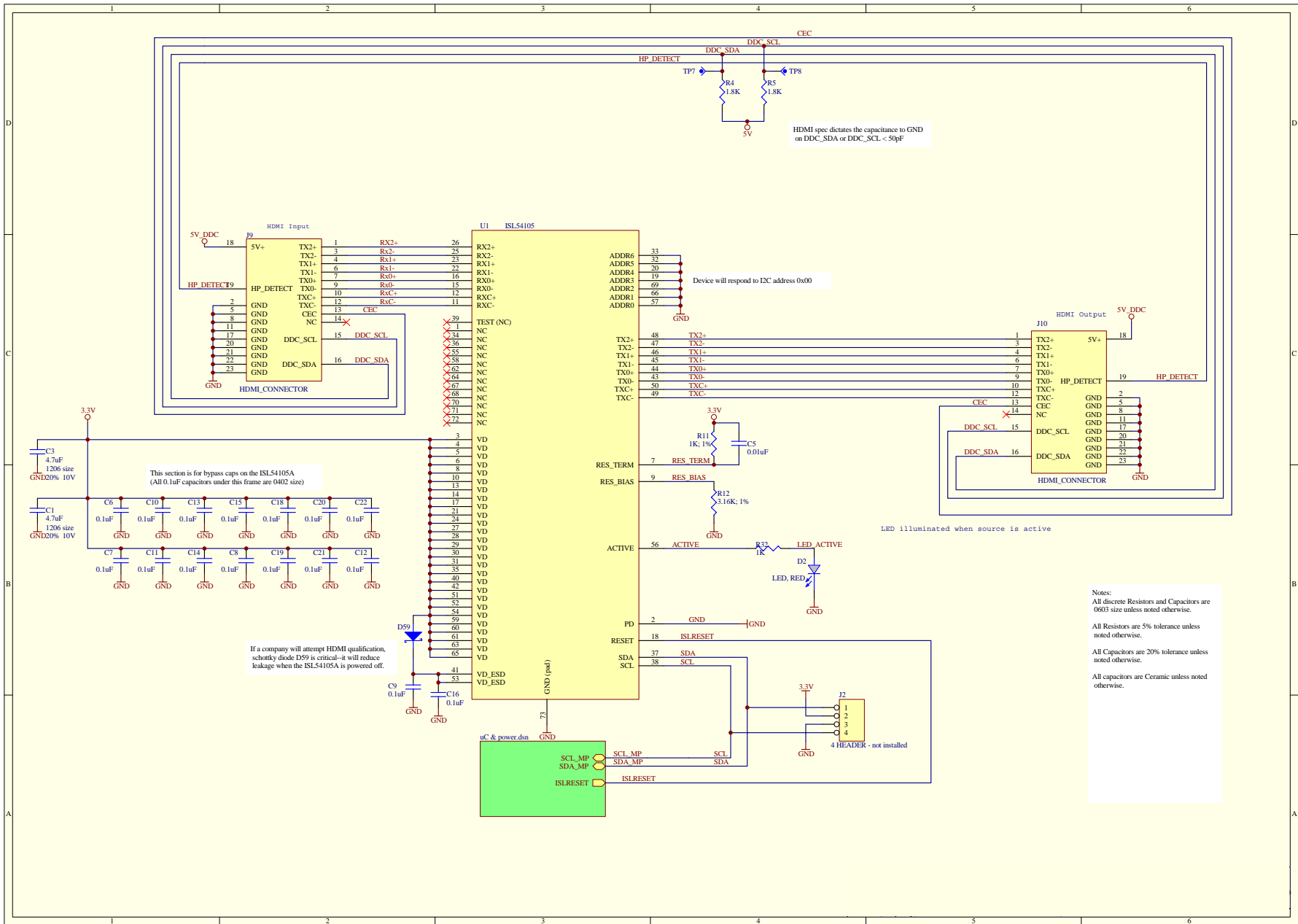

FIGURE 26. ISL54105ACRZ-EVALZ MAIN

Application Note 1453

TABLE 6. ISL54100HDMI-EVALZ BILL OF MATERIALS

PART NUMBER	QTY	UNITS	REFERENCE DESIGNATOR	DESCRIPTION	MANUFACTURER	MANUFACTURER PART
ISL54100HDMI-EVALZRVPCB	1	ea		PWB-PCB, ISL54100HDMI-EVALZ, RVC, ROHS	TBD	ISL54100HDMI-EVALZRVPCB
H1044-00103-25V10-T	2	ea	C104, C108	CAP, SMD, 0402, 0.01µF, 25V, 10%, X7R, ROHS	AVX	04023C103KAT
H1044-00104-25V10-T	40	ea	C11-C19, C21-C39, C81, C84, C87-C89, C91	CAP, SMD, 0402, 0.1µF, 25V, 10%, X5R, ROHS	TDK	C1005X5R1E104K
H1044-00104-25V10-T	0	ea	C95, C96, C102, C103	CAP, SMD, 0402, 0.1µF, 25V, 10%, X5R, ROHS	TDK	C1005X5R1E104K
H1045-00104-25V10-T	9	ea	C5, C6, C8, C20, C41, C42, C44, C48, C90	CAP, SMD, 0603, 0.1µF, 25V, 10%, X7R, ROHS	MURATA	GRM39X7R104K025AD
H1045-00105-25V10-T	6	ea	C1, C9, C40, C43, C47, C86	CAP, SMD, 0603, 1µF, 25V, 10%, X5R, ROHS	MURATA	GRM188R61E105KA12D
H1045-00222-50V10-T	1	ea	C10	CAP, SMD, 0603, 2200pF, 50V, 10%, X7R, ROHS	PANASONIC	ECJ-1VBH222K
H1045-00333-25V10-T	1	ea	C46	CAP, SMD, 0603, 33000pF, 25V, 10%, X7R, ROHS	PANASONIC	ECJ-1VB1E333K
H1065-00106-10V10-T	4	ea	C2-C4, C45	CAP, SMD, 1206, 10µF, 10V, 10%, X7R, ROHS	VENKEL	C1206X7R100-106KNE
H1065-00226-6R3V10-T	1	ea	C7	CAP, SMD, 1206, 22µF, 6.3V, 10%, X5R, ROHS	MURATA	GRM31CR60J226KE19L
1008PS-182KLB	1	ea	L1	COIL-PWR INDUCTOR, SMD, 3.8mm, 1.8µH, 10%, 2.1A, 225MHz, SHIELDED	COILCRAFT	1008PS-182K
47151-1001	5	ea	J7-J11	CONN-HDMI HEADER ASSY, SMD, 19P, RECEPT., R/A, ROHS	MOLEX	47151-1001
61729-0010BLF	1	ea	J12	CONN-USB TYPE B, RECEPTACLE, PCB MOUNT, R/A, ROHS	FCI	61729-0010BLF
90131-0125	1	ea	J2	CONN-HEADER, TH, 2X5, 2.54mm, TIN, STRAIGHT, ROHS	MOLEX	90131-0125
PJ-202A	1	ea	J1	CONN-POWER JACK, BLACK, 2.1mm, PCB MNT, R/A, ROHS	CUI, INC	PJ-202A
BAV70-TP	1	ea	D4	DIODE-DUAL SWITCHING, SMD, SOT23, 3P, 75V, 350mW, ROHS	MICRO COMMERCIAL CO.	BAV70-TP
BZX84C5V6LT1G-T	1	ea	D9	DIODE-ZENER, SMD, SOT23, 5.6V, 225mW, ROHS	ON SEMICONDUCTOR	BZX84C5V6LT1G
NSR0320MW2T1G-T	1	ea	D59	DIODE-SCHOTTKY BARRIER, SMD, 2P, SOD-323, 20V, 1A, ROHS	ON SEMICONDUCTOR	NSR0320MW2T1G
597-3111-407F-T	3	ea	D1 D3 D6	LED, SMD, 1206, RED, 30mA, 60mW, 17mcd, ROHS	DIALIGHT	597-3111-407F
597-3311-407F-T	7	ea	D2, D10, D11, D16-D18, D20	LED, SMD, 1206, GREEN, 75mW, 3mcd, Pb-Free	DIALIGHT	597-3311-407F
C1Q-1	1	ea	F4	FUSE, SMD, 1206, 1A, 125V, 0.21W, VERY FAST-ACTING, ROHS	BEL FUSE INC.	C1Q-1
C1Q-500	1	ea	F3	FUSE, SMD, 1206, 0.5A, 125V, 0.14W, VERY FAST-ACTING, ROHS	BEL FUSE INC.	C1Q-500

Application Note 1453

TABLE 6. ISL54100HDMI-EVALZ BILL OF MATERIALS (Continued)

PART NUMBER	QTY	UNITS	REFERENCE DESIGNATOR	DESCRIPTION	MANUFACTURER	MANUFACTURER PART
C8051F320-GQ	1	ea	U2 (Program by Engineer after installation)	IC-USB MICROCONTROLLER, 32P, LQFP, 10-BIT, 25MIPS, ROHS	SILICON LABORATORIES	C8051F320-GQ
EL7532IYZ	1	ea	U3	IC-2A STEP-DOWN REGULATOR, 10P, MSOP, MONOLITHIC	INTERSIL	EL7532IY
ISL43840IRZ	1	ea	U8	IC-DUAL MULTIPLEXER ANALOG SWITCH, 20P, QFN, 4X4, ROHS	INTERSIL	ISL43840IRZ
ISL54100CQZ	1	ea	U1	IC-TMDS REGENERATOR, 128P, MQFP, ROHS	INTERSIL	ISL54100CQZ
ISL54103IHZ	1	ea	U12	IC-DDC ACCELERATOR, 5P, SOT-23, ROHS	INTERSIL	ISL54103IHZ
PESD0402-060-T	40	ea	D5, D7, D8, D12-D15, D21-D53	TVS-ZENER DIODE, ESD PROTECTOR, SMD, 0402, 6V, ROHS	TYCO ELECTRONICS RAYCHEM	PESD0402-060
MMUN2211LT1G-T	7	ea	Q1-Q5, Q30, Q31	TRANSISTOR-NPN, BIAS RESISTOR, SOT23, 50V, 100mA, ROHS	ON SEMICONDUCTOR	MMUN2211LT1G
SI2323DS-T1-E3	1	ea	Q6	TRANSIST-MOS, P-CHANNEL, SMD, SOT23, -20V, -3.7A, ROHS	VISHAY	SI2323DS-T1-E3
H2510-01001-1/16W1-T	1	ea	R12	RES, SMD, 0402, 1k, 1/16W, 1%, TF, ROHS	VENKEL	CR0402-16W-102JT
H2510-03161-1/16W1-T	1	ea	R13	RES, SMD, 0402, 3.16k, 1/16W, 1%, TF, ROHS	VENKEL	CR0402-16W-3161FT
H2511-00R00-1/10W-T	8	ea	R21, R26, R28, R82-R85, R211	RESISTOR, SMD, 0603, 0Ω, 1/10W, TF, ROHS		
H2511-01000-1/10W5-T	1	ea	R22	RES, SMD, 0603, 100Ω, 1/10W, 5%, TF, ROHS	PANASONIC	ERJ-3GSYJ101V
H2511-01001-1/10W5-T	12	ea	R1-R5, R7, R14-R18, R27	RES, SMD, 0603, 1k, 1/10W, 5%, TF, ROHS	ROHM	MCR03EZPJ102
H2511-01003-1/10W5-T	1	ea	R210	RES, SMD, 0603, 100k, 1/10W, 5%, TF, ROHS	YAGEO	9C06031A1003JLHFT
H2511-01502-1/10W5-T	4	ea	R34-R37	RES, SMD, 0603, 15k, 1/10W, 5%, TF, ROHS	PANASONIC	ERJ-3GEYJ153V
H2511-02103-1/10W1-T	1	ea	R23	RES, SMD, 0603, 210k, 1/10W, 1%, TF, ROHS	VENKEL	CR0603-10W-2103FT
H2511-03012-1/10W1-T	1	ea	R80	RESISTOR, SMD, 0603, 30.1k, 1/10W, 1%, TF, ROHS	VENKEL	CR0603-10W-3012FT
H2511-05100-1/10W5-T	9	ea	R6, R8-R11, R19, R20, R190, R200	RES, SMD, 0603, 510Ω, 1/10W, 5%, TF, ROHS	VENKEL	CR0603-16W-511JT
H2511-09532-1/10W1-T	1	ea	R81	RES, SMD, 0603, 95.3k, 1/10W, 1%, TF, ROHS	VENKEL	CR0603-10W-9532FT
206-4	1	ea	SW6	SWITCH, TH, DIP, 4P, RAISED, TOP ACTUATED, SPST, ROHS	CTS	206-4
B3S-1000	1	ea	SW3	SWITCH-TACTILE, PUSH, SMD, 6mm, SPST, MOM, 160gf, ROHS	OMRON	B3S-1000
4-40X1/2-SCREW	4	ea	Four corners	SCREW, 4-40X1/2in, PAN, NYLON, PHILLIPS, ROHS		
4-40X3/4-STANDOFF	4	ea	Four corners	STANDOFF, 4-40X3/4in, F/F, HEX, NYLON	KEYSTONE	1902D

Application Note 1453

TABLE 6. ISL54100HDMI-EVALZ BILL OF MATERIALS (Continued)

PART NUMBER	QTY	UNITS	REFERENCE DESIGNATOR	DESCRIPTION	MANUFACTURER	MANUFACTURER PART
10X12-STATIC-BAG	1	ea	Place assy in bag	BAG, STATIC,10X12, ZIP LOC	INTERSIL	212403-015
DNP	0	ea	D54-D57	DO NOT POPULATE OR PURCHASE		
DNP	0	ea	J13-J18	DO NOT POPULATE OR PURCHASE		
DNP	0	ea	JP1-JP3	DO NOT POPULATE OR PURCHASE		
DNP	0	ea	R24, R25, R29-R33	DO NOT POPULATE OR PURCHASE		
DNP	0	ea	SW1	DO NOT POPULATE OR PURCHASE		
DNP	0	ea	TP1-TP3, TP13-TP20, TP22-TP24	DO NOT POPULATE OR PURCHASE		
LABEL-SERIAL NUMBER	1	ea		LABEL, FOR SERIAL NUMBER AND BOM REV #		

Application Note 1453

TABLE 7. ISL54105ACRZ-EVALZ BILL OF MATERIALS

PART NUMBER	QTY	UNITS	REFERENCE DESIGNATOR	DESCRIPTION	MANUFACTURER	MANUFACTURER PART
ISL54105ACRZ-EVALZRVBPCB	1	ea		PWB-PCB, ISL54105ACRZ-EVALZ, REV B, ROHS	GORILLA CIRCUITS INC.	ISL54105ACRZ-EVALZRVBPCB
H1044-00103-25V10-T	1	ea	C5	CAP, SMD, 0402, 0.01 μ F, 25V, 10%, X7R, ROHS	AVX	04023C103KAT
H1044-00104-25V10-T	16	ea	C6-C16, C18-C22	CAP, SMD, 0402, 0.1 μ F, 25V, 10%, X5R, ROHS	TDK	C1005X5R1E104K
H1045-00105-25V10-T	4	ea	C92, C93, C94, C99	CAP, SMD, 0603, 1 μ F, 25V, 10%, X5R, ROHS	MURATA	GRM188R61E105KA12D
H1065-00106-25V10-T	2	ea	C2, C4	CAP, SMD, 1206, 10 μ F, 25V, 10%, X5R, ROHS	VENKEL	C1206X5R250-106KNE
H1065-00475-25V10-T	2	ea	C1, C3	CAP, SMD, 1206, 4.7 μ F, 25V, 10%, X5R, ROHS	KEMET	C1206C475K3PACTU
500254-1927	2	ea	J9, J10	CONN-HDMI RECEPTACLE, SMD, 15x12, 19P, R/A, ROHS	MOLEX	500254-1927
61729-0010BLF	1	ea	CON3	CONN-USB TYPE B, RECEPTACLE, PCB MOUNT, R/A, ROHS	FCI	61729-0010BLF
68000-236-1X4	0	ea	DNP (J2, J3)	CONN-HEADER, 1X4, BRKAWY 1X36, 2.54mm, ST	BERG/FCI	68000-236
68000-236-1X6	0	ea	DNP (J11)	CONN-HEADER, 1X6, BRKAWY 1X36, 2.54mm, ST	BERG/FCI	68000-236
69190-202HLF	1	ea	JP2	CONN-HEADER, 1X2, RETENTIVE, 2.54mm, ST, ROHS	BERG/FCI	69190-202HLF
90131-0125	1	ea	J8	CONN-HEADER, TH, 2X5, 2.54mm, TIN, STRAIGHT, ROHS	MOLEX	90131-0125
PJ-202A	1	ea	J1	CONN-POWER JACK, BLACK, 2.1mm, PCB MNT, R/A, ROHS	CUI, INC	PJ-202A
SPC02SYAN	1	ea	JP2	CONN-JUMPER, SHORTING, 2PIN, BLACK, GOLD, ROHS	SULLINS	SPC02SYAN
NSR0320MW2T1G-T	1	ea	D59	DIODE-SCHOTTKY BARRIER, SMD, 2P, SOD-323, 20V, 1A, ROHS	ON SEMICONDUCTOR	NSR0320MW2T1G
597-3111-407F-T	1	ea	D2	LED, SMD, 1206, RED, 30mA, 60mW, 17mcd, ROHS	DIALIGHT	597-3111-407F
597-3311-407F-T	2	ea	D1, D4	LED, SMD, 1206, GREEN, 75mW, 3mcd, Pb-Free	DIALIGHT	597-3311-407F
C8051F320-GQ	1	ea	U4	IC-USB MICROCONTROLLER, 32P, LQFP, 10-BIT, 25MIPS, ROHS	SILICON LABORATORIES	C8051F320-GQ
ISL54105ACRZ	1	ea	U1	IC-TMDS REGENERATOR, 72P, QFN, 10x10, ROHS	INTERSIL	ISL54105ACRZ
TPS77833D	1	ea	U2	IC-LDO REGULATOR, 8P, SOIC, POS.FIXED, 3.3V, 750mA, ROHS	TEXAS INSTRUMENTS	TPS77833D
742C083102JPTR	2	ea	RP3, RP4	RES ARRAY, SMD, 0603, 1k, 1/16W, 5%, 4 RES, ISOLATED, ROHS	CTS	742C083102JPTR
H2510-01001-1/16W1-T	1	ea	R11	RES, SMD, 0402, 1k, 1/16W, 1%, TF, ROHS	VENKEL	CR0402-16W-102JT
H2510-03161-1/16W1-T	1	ea	R12	RES, SMD, 0402, 3.16k, 1/16W, 1%, TF, ROHS	VENKEL	CR0402-16W-3161FT
H2511-01001-1/10W1-T	7	ea	R18, R19, R32-R36	RES, SMD, 0603, 1k, 1/10W, 1%, TF, ROHS	KOA	RK73H1JTDD1001F

Application Note 1453

TABLE 7. ISL54105ACRZ-EVALZ BILL OF MATERIALS (Continued)

PART NUMBER	QTY	UNITS	REFERENCE DESIGNATOR	DESCRIPTION	MANUFACTURER	MANUFACTURER PART
H2511-01801-1/10W1-T	2	ea	R4, R5	RES, SMD, 0603, 1.8k, 1/10W, 1%, TF, ROHS	VENKEL	CR0603-10W-1801FT
H2513-00020-1/2W1-T	1	ea	R1	RES, SMD, 1206, 2 Ω , 1/2W, 1%, TF, ROHS	SUSUMU	RL1632R-2R00-F
94HBB16T	2	ea	SW3, SW4	SWITCH-ROTARY DIP, TH, 16POS, SPDT, HEXADECIMAL, ROHS	GRAYHILL	94HBB16T
B3S-1000	1	ea	SW2	SWITCH-TACTILE, PUSH, SMD, 6mm, SPST, MOM, 160gf, ROHS	OMRON	B3S-1000
4-40X1/2-SCREW	4	ea	Four corners	SCREW, 4-40X1/2in, PAN, NYLON, PHILLIPS, ROHS		
4-40X3/4-STANDOFF	4	ea	Four corners	STANDOFF, 4-40X3/4in, F/F, HEX, NYLON	KEYSTONE	1902D
5X8-STATIC-BAG	1	ea	Place assy in bag	BAG, STATIC, 5X8, ZIP LOC	INTERSIL	212403-013
DNP	0	ea	TP1-TP8	DO NOT POPULATE OR PURCHASE		
LABEL-SERIAL NUMBER	1	ea		LABEL, FOR SERIAL NUMBER AND BOM REV #		

ISL54100AHDMI-EVALZ Layout

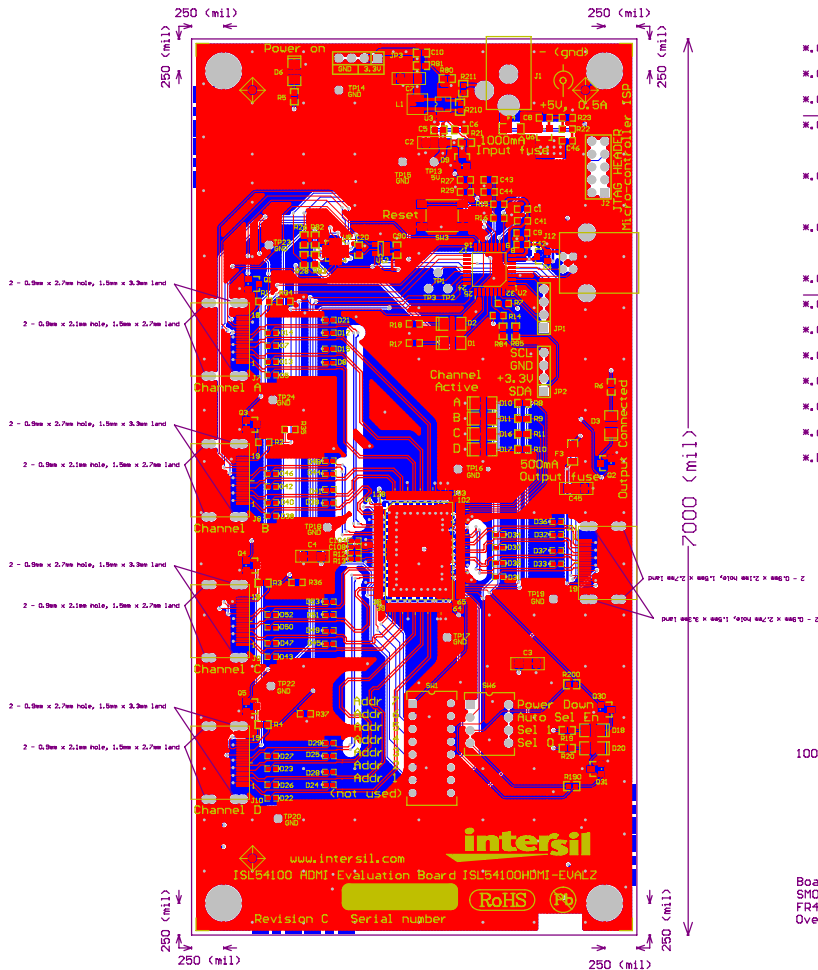

- *GTP : Top solder paste
- *GTO : Top overlay (legend)
- *GTS : Top solder mask
- *GTL : Top signal layer
 - 1 oz. copper
 - 8 mil FR408 (core) This thickness set for 100 ohm differential impedance nets
- *GPI : Ground Plane
 - 1 oz. copper
 - FR408 (prepreg) adjust thickness for 62 mil thick board
- *GP2 : Voltage Plane
 - 1 oz. copper
 - 8 mil FR408 (core) This thickness set for 100 ohm differential impedance nets
- *GBL : Bottom signal layer
 - 1 oz. copper
- *GBS : Bottom solder mask
- *GM2 : Mechanical information (dimensions and fabrication information)
- *GM1 : Board outline
- *GG1 : Hole locations
- *GD1 : Hole size symbols
- *APR : Aperture table
- *REP : Report file

100 ohm differential impedance nets information
 Impedance tolerance 5%
 100-ohm differential nets on top and bottom layers
 9.75 mil trace width
 9.25 mil trace to trace airgap
 8 mil FR408 core dielectric

Board finish to be immersion surface finish of ENIG (Electroless Nickel 100 micro inches min. / Immersion Gold 2 - 10 micro inches)
 SMOBC (LPI) color red
 FR408 color natural
 Overlay (legend) color white

Top Paste
 Top Overlay
 Top Solder Mask
 Top Layer

Bottom Layer
 Bottom Solder Mask

Bottom Paste
 Mechanical Layer 2

FIGURE 28. TOP SILK SCREEN

ISL54100AHDMI-EVALZ Layout (Continued)

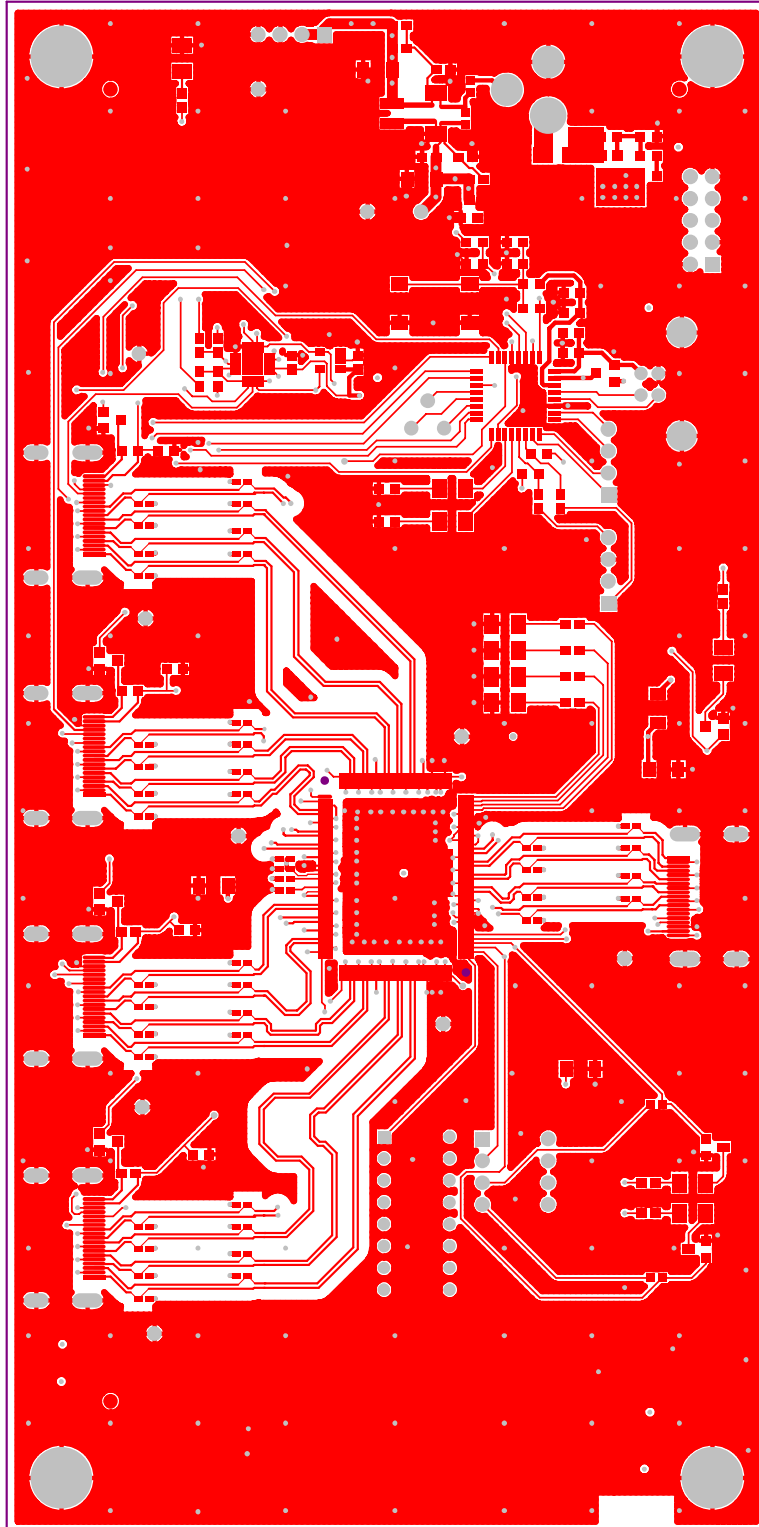

Top Paste

Top Solder Mask

Top Layer

FIGURE 29. TOP LAYER, TOP SOLDER MASK AND TOP PASTE

ISL54100AHDMI-EVALZ Layout (Continued)

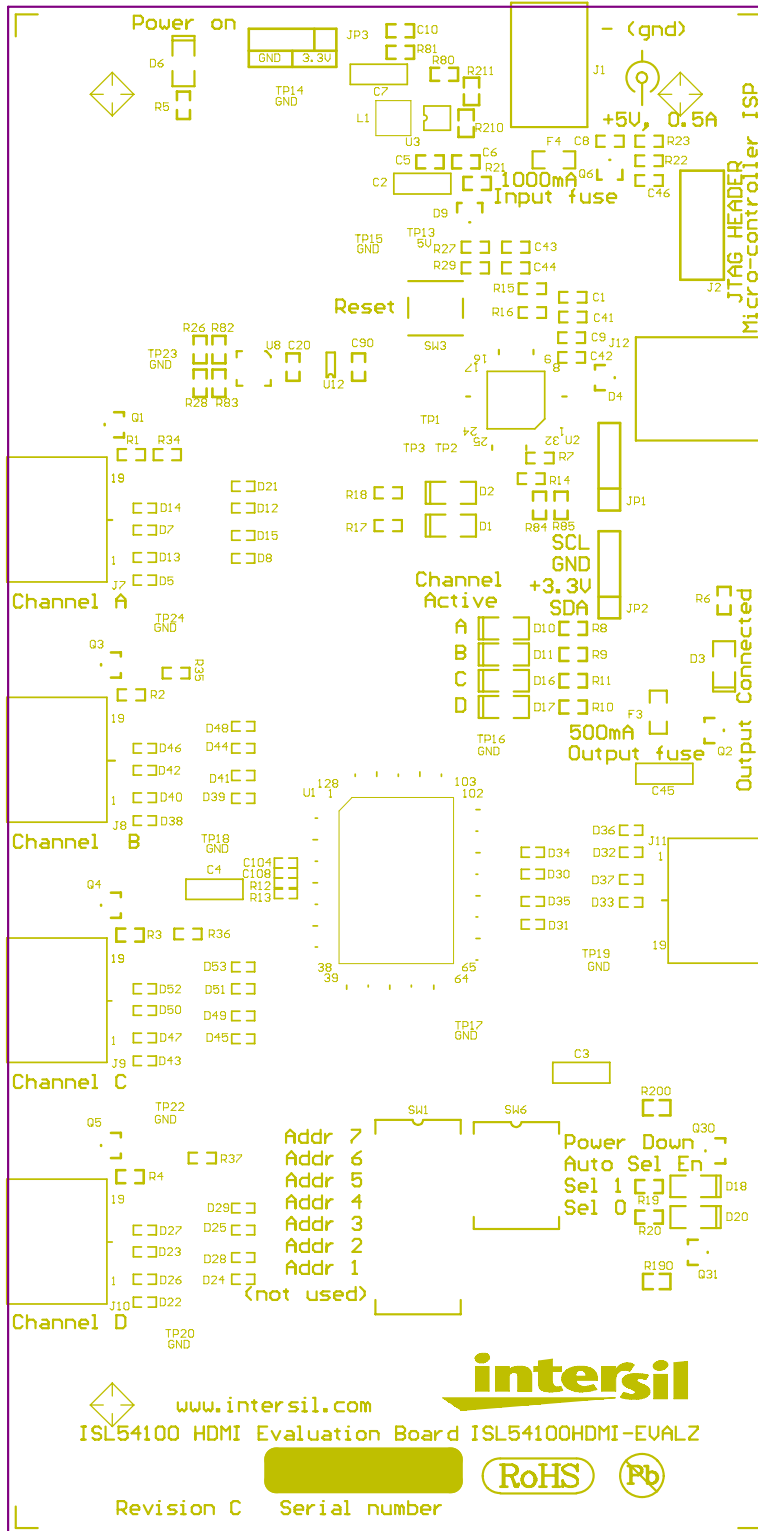

Top Overlay

FIGURE 30. TOP OVERLAY

ISL54100AHDMI-EVALZ Layout (Continued)

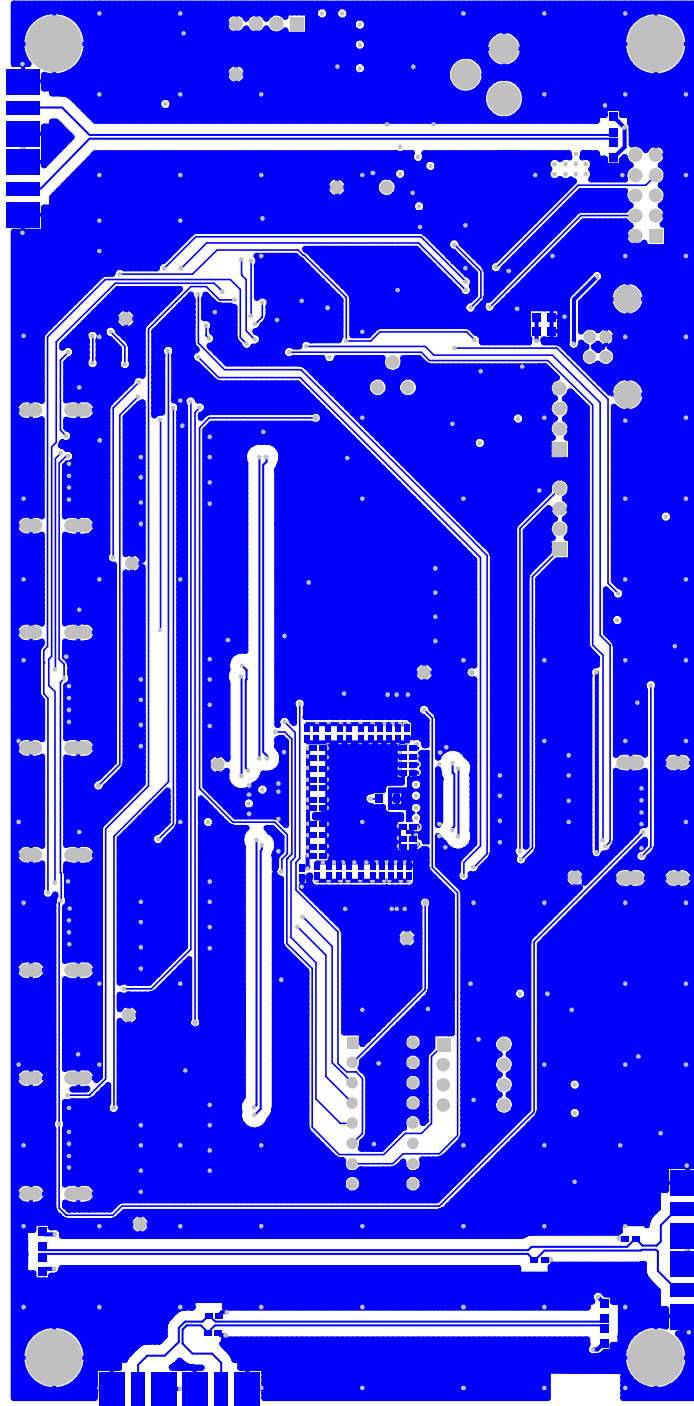

Bottom Layer
Bottom Solder Mask
Bottom Paste

FIGURE 31. BOTTOM LAYER, BOTTOM SOLDER MASK AND BOTTOM PASTE

ISL54100AHDMI-EVALZ Layout (Continued)

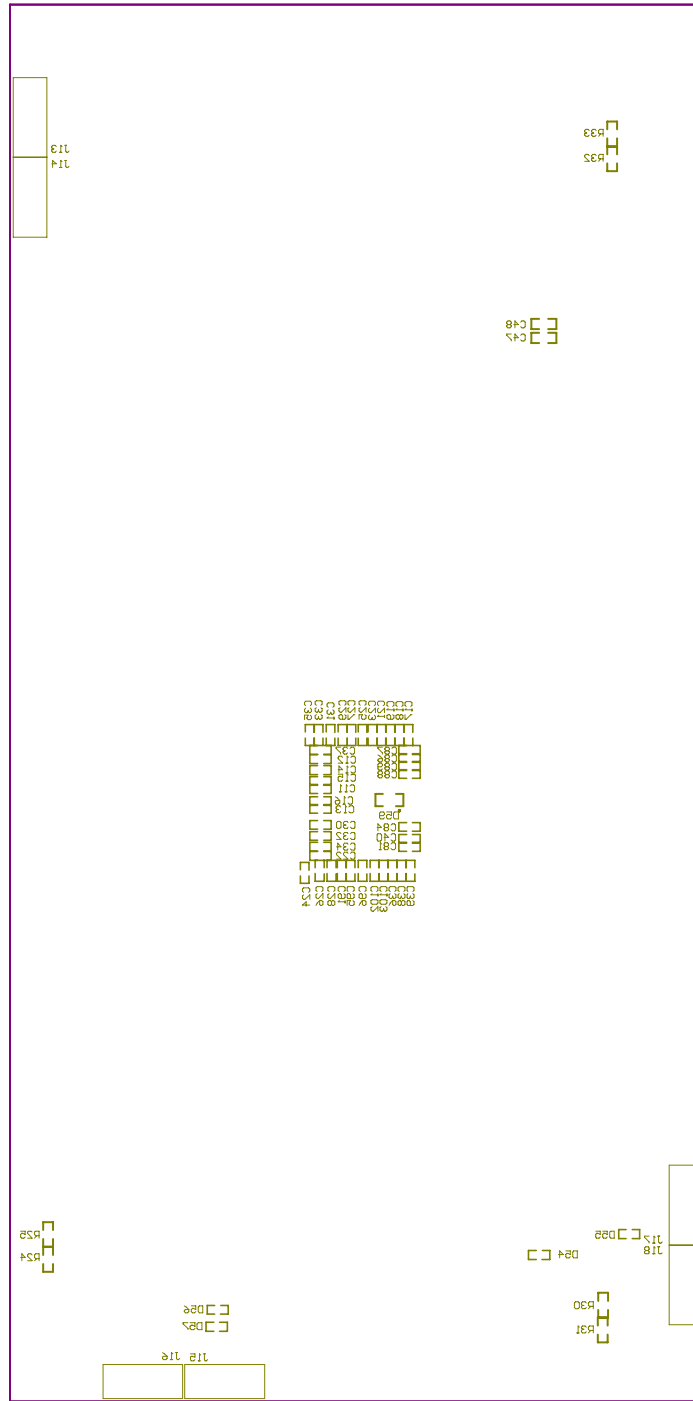

Bottom Overlay

FIGURE 32. BOTTOM OVERLAY

ISL54100AHDMI-EVALZ Layout (Continued)

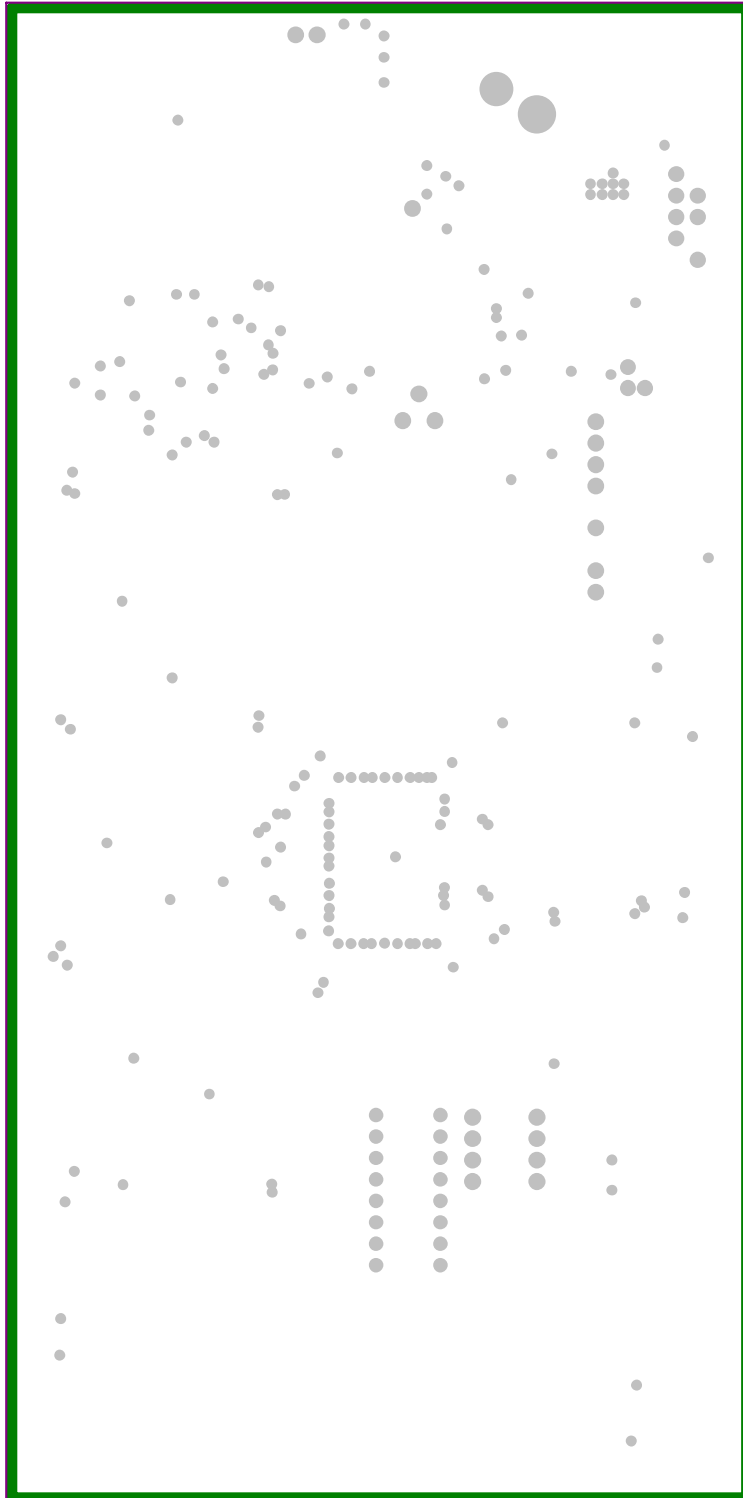

Internal Plane 1

FIGURE 33. INTERNAL PLANE 1

ISL54100AHDMI-EVALZ Layout (Continued)

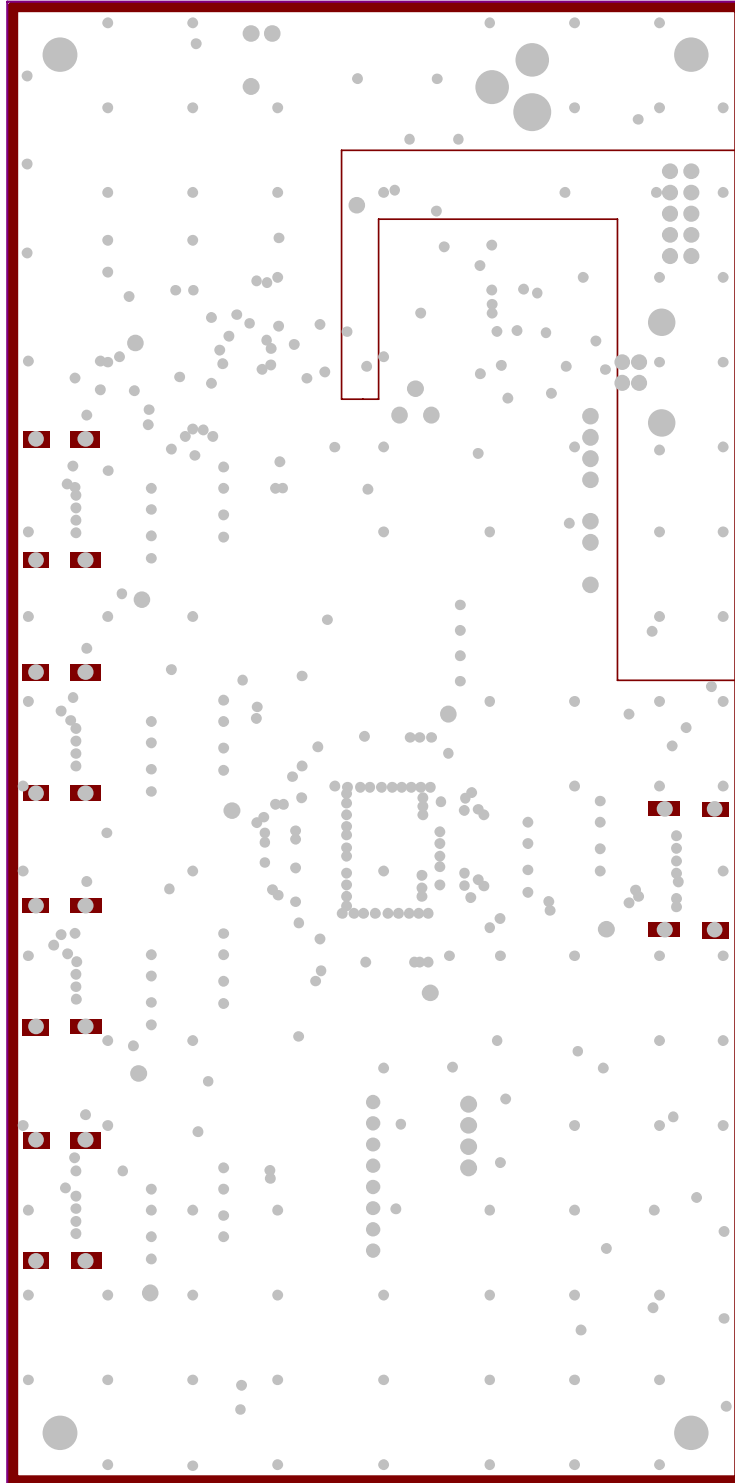

Internal Plane 2

FIGURE 34. INTERNAL PLANE 2

ISL54105ACRZ-EVALZ Layout

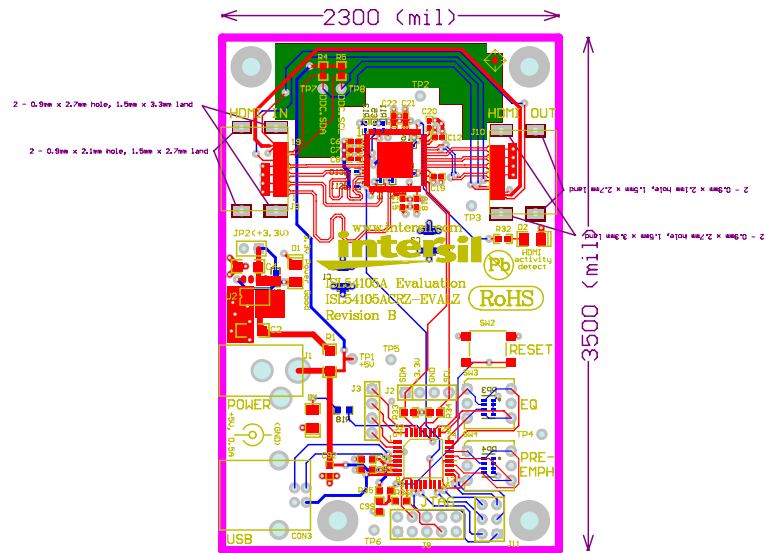

- *.GTP : Top solder paste
- *.GT0 : Top overlay (legend)
- *.GTS : Top solder mask
- *.GTL : Top signal layer

1 oz. copper	
6.3 mil FR408	This thickness set for 100 ohm differential impedance nets
- *.GPI : Ground Plane

1 oz. copper	
FR408 adjust thickness for 62 mil thick board	
- *.GP2 : Voltage Plane

1 oz. copper	
6.3 mil FR408	This thickness set for 100 ohm differential impedance nets
- *.GBL : Bottom signal layer

1 oz. copper	
--------------	--
- *.GBS : Bottom solder mask
- *.GM2 : Mechanical information (dimensions and fabrication information)
- *.GM1 : Board outline
- *.GG1 : Hole locations
- *.GD1 : Hole size symbols
- *.APR : Aperture table
- *.REP : Report file

- Top Paste
- Top Overlay
- Top Solder Mask
- Top Layer
- Internal Plane 1
- Internal Plane 2
- Bottom Layer
- Bottom Overlay
- Mechanical Layer 2

Keep Out Layer

- 100 ohm differential impedance nets information
 - 100-ohm differential nets on top and bottom layers
 - 8.0 mil trace width
 - 9.0 mil trace to trace airgap
 - 6.3 mil FR408 dielectric

- Board finish to be immersion surface finish of ENIG
 - (Electroless Nickel 100 micro inches min. / Immersion Gold 2 - 10 micro inches)
 - SMOBC (LPI) color red
 - FR408 color natural
 - Overlay (Legend) color white

FIGURE 35. TOP SILK SCREEN

ISL54105ACRZ-EVALZ Layout (Continued)

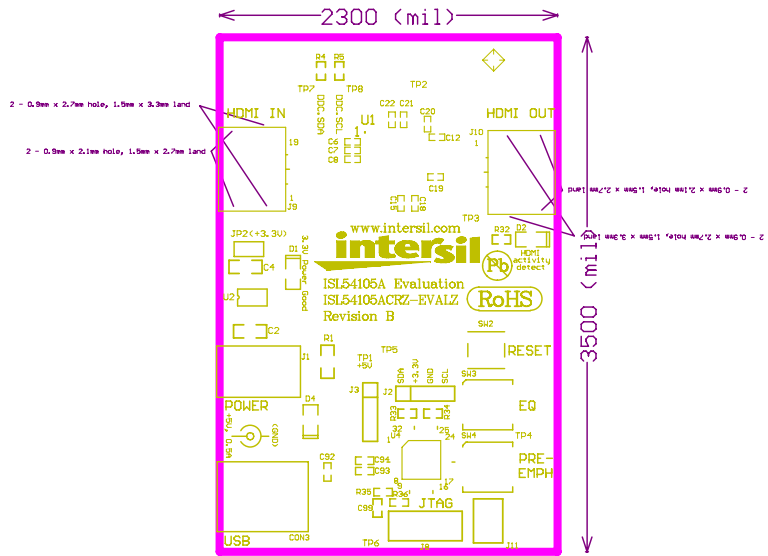

- *.GTP : Top solder paste
- *.GTO : Top overlay (legend)
- *.GTS : Top solder mask
- *.GTL : Top signal layer
 - 1 oz. copper
 - 6.3 mil FR408 This thickness set for 100 ohm differential impedance nets
- *.GP1 : Ground Plane
 - 1 oz. copper
 - FR408 adjust thickness for 62 mil thick board
- *.GP2 : Voltage Plane
 - 1 oz. copper
 - 6.3 mil FR408 This thickness set for 100 ohm differential impedance nets
- *.GBL : Bottom signal layer
 - 1 oz. copper
- *.GBS : Bottom solder mask
- *.GM2 : Mechanical information (dimensions and fabrication information)
- *.GM1 : Board outline
- *.GG1 : Hole locations
- *.GDI : Hole size symbols
- *.APR : Aperture table
- *.REP : Report file

100 ohm differential impedance nets information
 100-ohm differential nets on top and bottom layers
 8.0 mil trace width
 9.0 mil trace to trace airgap
 6.3 mil FR408 dielectric

Board finish to be immersion surface finish of ENIG
 (Electroless Nickel 100 micro inches min. / Immersion Gold 2 - 10 micro inches)
 SMOBC (LPI) color red
 FR408 color natural
 Overlay (legend) color white

FIGURE 36. TOP OVERLAY AND MECHANICAL LAYER 2

ISL54105ACRZ-EVALZ Layout (Continued)

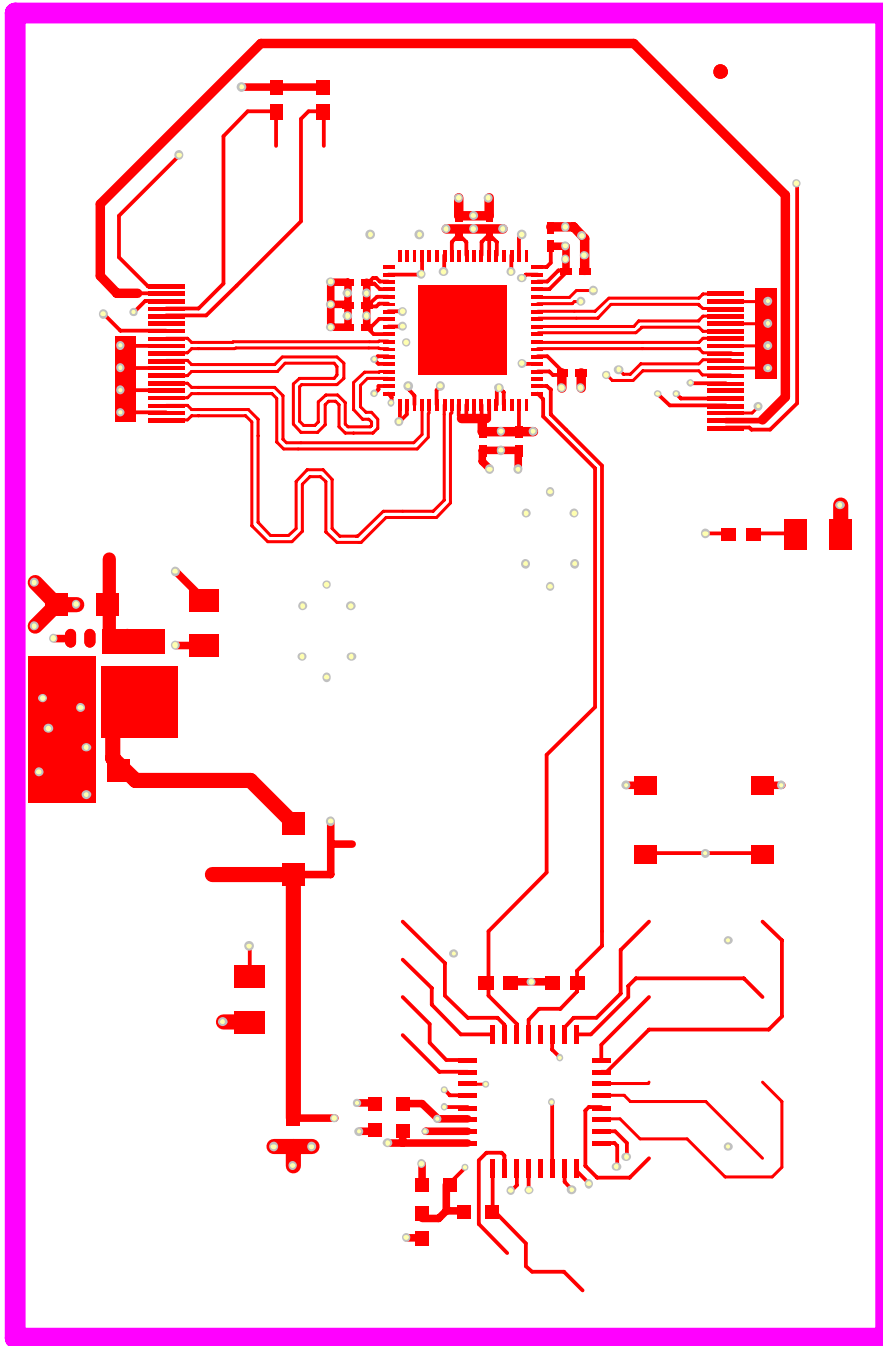

Top Paste

Keep Out Layer

Top Layer

FIGURE 37. TOP LAYER AND TOP PASTE

ISL54105ACRZ-EVALZ Layout (Continued)

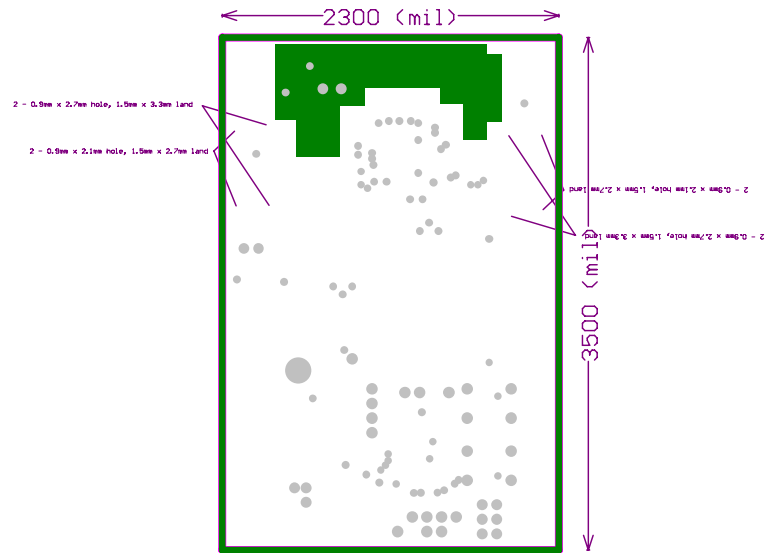

- *.GTP : Top solder paste
- *.GT0 : Top overlay (legend)
- *.GTS : Top solder mask
- *.GTL : Top signal layer 1 oz. copper
- *.GTL : Top signal layer 6.3 mil FR408 This thickness set for 100 ohm differential impedance nets
- *.GP1 : Ground Plane 1 oz. copper
- *.GP2 : Voltage Plane 1 oz. copper
- *.GP2 : Voltage Plane FR408 adjust thickness for 62 mil thick board
- *.GBL : Bottom signal layer 1 oz. copper
- *.GBS : Bottom solder mask
- *.GM2 : Mechanical information (dimensions and fabrication information)
- *.GM1 : Board outline
- *.GG1 : Hole locations
- *.GD1 : Hole size symbols
- *.APR : Aperture table
- *.REP : Report file

Internal Plane 1

Keep Out Layer

Mechanical Layer 2

100 ohm differential impedance nets information

- 100-ohm differential nets on top and bottom layers
- 8.0 mil trace width
- 9.0 mil trace to trace airgap
- 6.3 mil FR408 dielectric

Board finish to be immersion surface finish of ENIG
 (Electroless Nickel 100 micro inches min. / Immersion Gold 2 - 10 micro inches)
 SMOBC (LPI) color red
 FR408 color natural
 Overlay (legend) color white

FIGURE 38. INTERNAL PLANE 1 AND MECHANICAL LAYER 2

ISL54105ACRZ-EVALZ Layout (Continued)

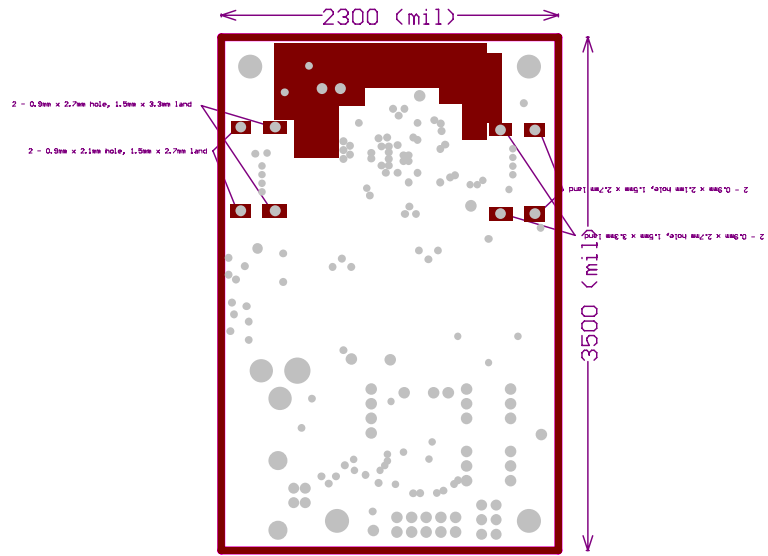

Keep Out Layer

Internal Plane 2

Mechanical Layer 2

- *.GTP : Top solder paste
- *.GTO : Top overlay (legend)
- *.GTS : Top solder mask
- *.GTL : Top signal layer
 - 1 oz. copper
 - 6.3 mil FR408 This thickness set for 100 ohm differential impedance nets
- *.GP1 : Ground Plane
 - 1 oz. copper
 - FR408 adjust thickness for 62 mil thick board
- *.GP2 : Voltage Plane
 - 1 oz. copper
 - 6.3 mil FR408 This thickness set for 100 ohm differential impedance nets
- *.GBL : Bottom signal layer
 - 1 oz. copper
- *.GBS : Bottom solder mask
- *.GM2 : Mechanical information (dimensions and fabrication information)
- *.GM1 : Board outline
- *.GG1 : Hole locations
- *.GD1 : Hole size symbols
- *.APR : Aperture table
- *.REP : Report file

100 ohm differential impedance nets information
 100-ohm differential nets on top and bottom layers
 8.0 mil trace width
 9.0 mil trace to trace airgap
 6.3 mil FR408 dielectric

Board finish to be immersion surface finish of ENIG
 (Electroless Nickel 100 micro inches min. / Immersion Gold 2 - 10 micro inches)
 SMOBC (LPI) color red
 FR408 color natural
 Overlay (legend) color white

FIGURE 39. INTERNAL PLANE 2 AND MECHANICAL LAYER 2

ISL54105ACRZ-EVALZ Layout (Continued)

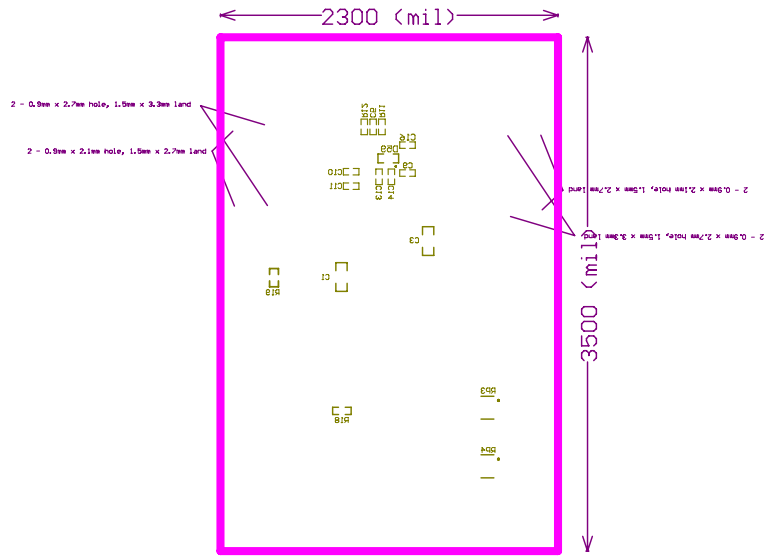

- *.GTP : Top solder paste
- *.GTO : Top overlay (legend)
- *.GTS : Top solder mask
- *.GTL : Top signal layer
 - 1 oz. copper
 - 6.3 mil FR408 This thickness set for 100 ohm differential impedance nets
- *.GP1 : Ground Plane
 - 1 oz. copper
 - FR408 adjust thickness for 62 mil thick board
- *.GP2 : Voltage Plane
 - 1 oz. copper
 - 6.3 mil FR408 This thickness set for 100 ohm differential impedance nets
- *.GBL : Bottom signal layer
 - 1 oz. copper
- *.GBS : Bottom solder mask
- *.GM2 : Mechanical information (dimensions and fabrication information)
- *.GM1 : Board outline
- *.GG1 : Hole locations
- *.GD1 : Hole size symbols
- *.APR : Aperture table
- *.REP : Report file

Keep Out Layer

Bottom Overlay
Mechanical Layer 2

100 ohm differential impedance nets information
 100-ohm differential nets on top and bottom layers
 8.0 mil trace width
 9.0 mil trace to trace airgap
 6.3 mil FR408 dielectric

Board finish to be immersion surface finish of ENIG
 (Electroless Nickel 100 micro inches min. / Immersion Gold 2 - 10 micro inches)
 SMOBC (LPI) color red
 FR408 color natural
 Overlay (legend) color white

FIGURE 40. BOTTOM OVERLAY AND MECHANICAL LAYER 2

ISL54105ACRZ-EVALZ Layout (Continued)

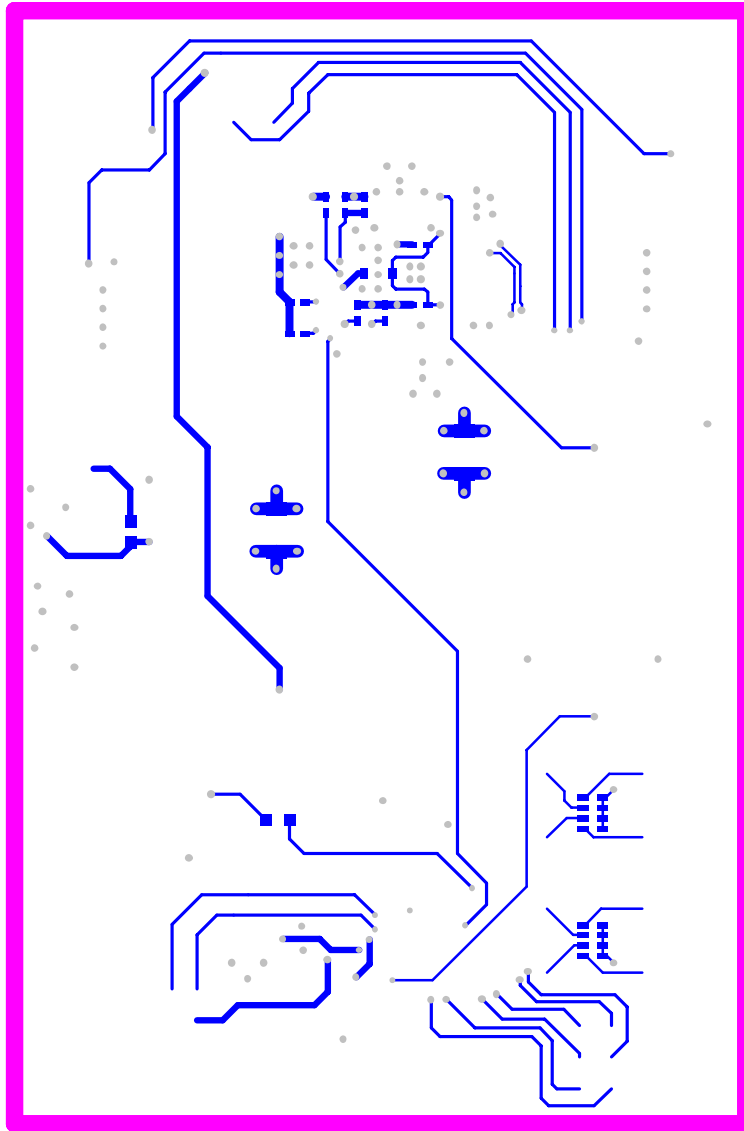

Keep Out Layer

Bottom Layer

Bottom Paste

FIGURE 41. BOTTOM LAYER AND BOTTOM PASTE

Intersil Corporation reserves the right to make changes in circuit design, software and/or specifications at any time without notice. Accordingly, the reader is cautioned to verify that the Application Note or Technical Brief is current before proceeding.

For information regarding Intersil Corporation and its products, see www.intersil.com



Стандарт Электрон Связь

Мы молодая и активно развивающаяся компания в области поставок электронных компонентов. Мы поставляем электронные компоненты отечественного и импортного производства напрямую от производителей и с крупнейших складов мира.

Благодаря сотрудничеству с мировыми поставщиками мы осуществляем комплексные и плановые поставки широчайшего спектра электронных компонентов.

Собственная эффективная логистика и склад в обеспечивает надежную поставку продукции в точно указанные сроки по всей России.

Мы осуществляем техническую поддержку нашим клиентам и предпродажную проверку качества продукции. На все поставляемые продукты мы предоставляем гарантию .

Осуществляем поставки продукции под контролем ВП МО РФ на предприятия военно-промышленного комплекса России , а также работаем в рамках 275 ФЗ с открытием отдельных счетов в уполномоченном банке. Система менеджмента качества компании соответствует требованиям ГОСТ ISO 9001.

Минимальные сроки поставки, гибкие цены, неограниченный ассортимент и индивидуальный подход к клиентам являются основой для выстраивания долгосрочного и эффективного сотрудничества с предприятиями радиоэлектронной промышленности, предприятиями ВПК и научно-исследовательскими институтами России.

С нами вы становитесь еще успешнее!

Наши контакты:

Телефон: +7 812 627 14 35

Электронная почта: sales@st-electron.ru

Адрес: 198099, Санкт-Петербург,
Промышленная ул, дом № 19, литера Н,
помещение 100-Н Офис 331