

MAX97003

High-Efficiency, Low-Noise Audio Subsystem

General Description

The MAX97003 audio subsystem combines a mono speaker amplifier with a stereo headphone amplifier. The headphone and speaker amplifiers have independent volume and on/off controls. The four inputs are configurable as two differential or four single-ended inputs.

To minimize output noise, both the headphone and speaker outputs utilize a downward expander/noise gate to attenuate noise when no desired input signal is present.

The speaker output incorporates an adjustable dynamic range compressor (DRC) and distortion limiter to protect the speaker and maximize loudness. This allows high gain for low-level signals without compromising the quality of large signals.

All controls are performed using the two-wire I²C interface. The IC operates in the extended -40°C to +85°C temperature range, and is available in the 2.0mm x 2.4mm, 20-bump WLP package (0.4mm pitch).

Applications

Cell Phones
Portable Media Players

Ordering Information appears at end of data sheet.

Features

- ◆ 2.7V to 5.5V Speaker Supply Voltage
- ◆ 1.8V Headphone Supply Voltage
- ◆ 1.0W Speaker Output ($V_{PVDD} = 4.2V$, $Z_{SPK} = 8\Omega + 68\mu H$, 1% THD+N)
- ◆ 32mW/Channel Headphone Output ($R_{HP} = 32\Omega$)
- ◆ Active Emissions Limiting for Enhanced EMI Reduction
- ◆ Efficient Class H Headphone Amplifier
- ◆ Ground-Referenced Headphone Outputs
- ◆ Headphone Ground Sense
- ◆ 2 Stereo Single-Ended/Mono Differential Inputs
- ◆ Integrated Expander/Noise Gate for Low Output Noise
- ◆ Integrated DRC (Speaker Outputs)
- ◆ Integrated Distortion Limiter (Speaker Outputs)
- ◆ Extensive Click-and-Pop Reduction Circuitry
- ◆ TDMA Noise Free
- ◆ 2.0mm x 2.4mm, 20-Bump WLP Package (0.4mm Pitch)

Simplified Block Diagram

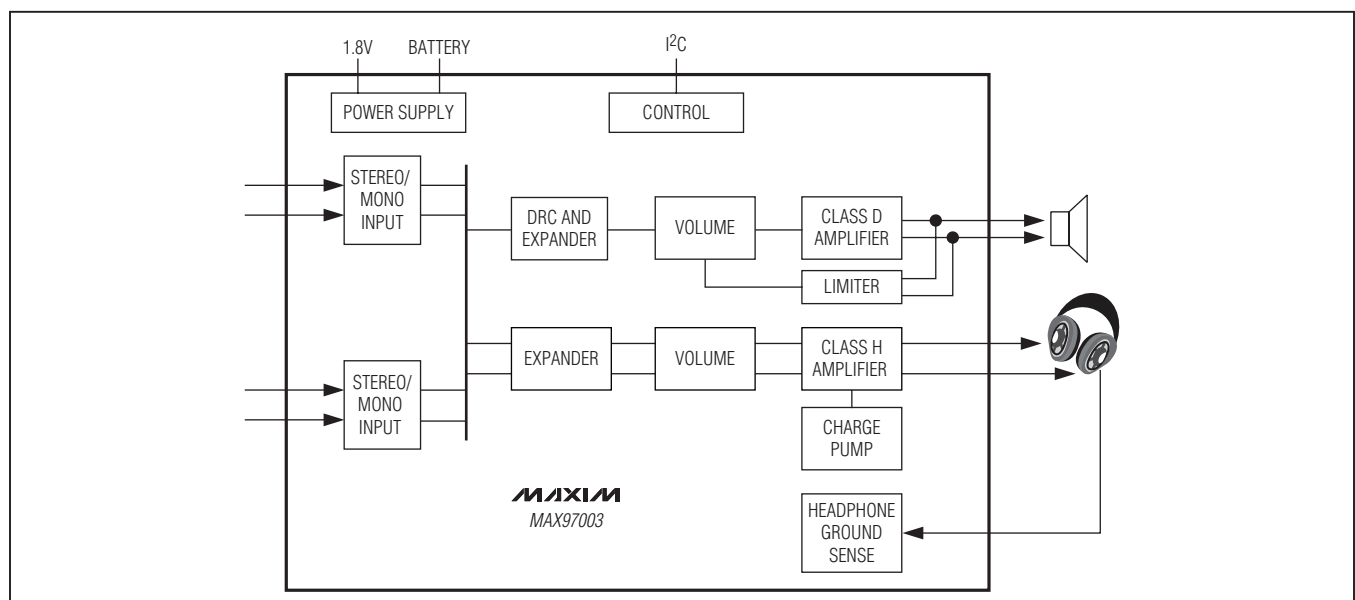

For related parts and recommended products to use with this part, refer to: www.maxim-ic.com/MAX97003.related.

High-Efficiency, Low-Noise Audio Subsystem

TABLE OF CONTENTS

General Description	1
Applications	1
Features	1
Simplified Block Diagram	1
Functional Diagram/Typical Application Circuit	6
Absolute Maximum Ratings	7
Electrical Characteristics	7
Digital I/O Characteristics	12
I ² C Timing Characteristics	13
Typical Operating Characteristics	14
Bump Configuration	21
Bump Description	21
Detailed Description	22
Signal Path	22
Class D Speaker Amplifier	22
Ultra-Low EMI Filterless Output Stage	23
Dynamic Range Compressor (DRC)	24
Expander	25
Speaker Low-Power Mode	26
Distortion Limiter	26
Headphone Amplifier	26
DirectDrive	26
Charge Pump	27
Class H Operation	28
Ground Sense	28
Volume-Change Features	28
Zero-Crossing Detection	28
Volume Slewing	28
Enhanced Volume Smoothing	28
Volume Readback	28
I ² C Slave Address	28
Registers Map	28
Volume Readback	30
Input Configuration	31
Mixers	32
Volume Control	33

High-Efficiency, Low-Noise Audio Subsystem

TABLE OF CONTENTS (continued)

Dynamic Range Control	34
Expander (Noise Gate)	35
Distortion Limiter	36
Speaker Low-Power Mode	37
Output Gain.	38
Advanced Configuration	39
Power Management	40
I ² C Serial Interface	40
Bit Transfer	41
START and STOP Conditions.	41
Early STOP Conditions.	41
Slave Address	41
Acknowledge	41
Write Data Format	42
Read Data Format	43
Applications Information.	44
Filterless Class D Operation	44
RF Susceptibility	44
Startup/Shutdown Sequencing	44
Component Selection	45
Optional Ferrite Bead Filter	45
Input Capacitor.	45
Charge-Pump Capacitor Selection	45
Charge-Pump Flying Capacitor	45
Charge-Pump Holding Capacitor	45
Supply Bypassing, Layout, and Grounding	45
WLP Applications Information	46
Ordering Information	46
Package Information.	47
Revision History	48

High-Efficiency, Low-Noise Audio Subsystem

LIST OF FIGURES

Figure 1. Signal Path	22
Figure 2. Stereo Single-Ended and Differential Input Configurations	23
Figure 3. EMI with 12in of Speaker Cable	23
Figure 4. Low-Signal to High-Signal Transition, No Clipping, DRC Disabled	24
Figure 5. Low-Signal to High-Signal Transition, Increased Gain, DRC Disabled.	24
Figure 6. Low-Signal to High-Signal Transition, Increased Gain, DRC Enabled	24
Figure 7. DRC Gain Curve	24
Figure 8. Expander Gain Curve	25
Figure 9. High-Signal to Low-Signal Transition, Expander Disabled	25
Figure 10. High-Signal to Low-Signal Transition, Expander Enabled.	25
Figure 11. High-Signal to Low-Signal Transition, Speaker Expander with Speaker Low-Power Mode	26
Figure 12. Limiter Gain Curve.	26
Figure 13. Traditional Amplifier Output vs. MAX97003 DirectDrive Output	27
Figure 14. Class H Operation	28
Figure 15. I ² C Serial Interface Timing Diagram	40
Figure 16. START, STOP, and REPEATED START Conditions	41
Figure 17. Acknowledge	41
Figure 18. Writing 1 Byte of Data to the IC	42
Figure 19. Writing n-Bytes of Data to the IC	42
Figure 20. Reading One Byte of Data from the IC.	43
Figure 21. Reading n-Bytes of Data from the IC	43
Figure 22. Optional Class D Ferrite Bead Filter	45
Figure 23. WLP Ball Dimensions	46

High-Efficiency, Low-Noise Audio Subsystem

LIST OF TABLES

Table 1. Register Map	29
Table 2. Volume Readback Registers	30
Table 3. Input Configuration Registers	31
Table 4. Mixer Registers	32
Table 5. Headphone Volume Control Registers	33
Table 6. Dynamic Range Control Registers	34
Table 7. Expander Registers	35
Table 8. Distortion Limiter Register	36
Table 9. Speaker Low-Power Mode Register	37
Table 10. Output Gain Register	38
Table 11. Advanced Configuration Control Register	39
Table 12. Power Management Register	40
Table 13. Startup Sequence.	44

High-Efficiency, Low-Noise Audio Subsystem

Functional Diagram/Typical Application Circuit

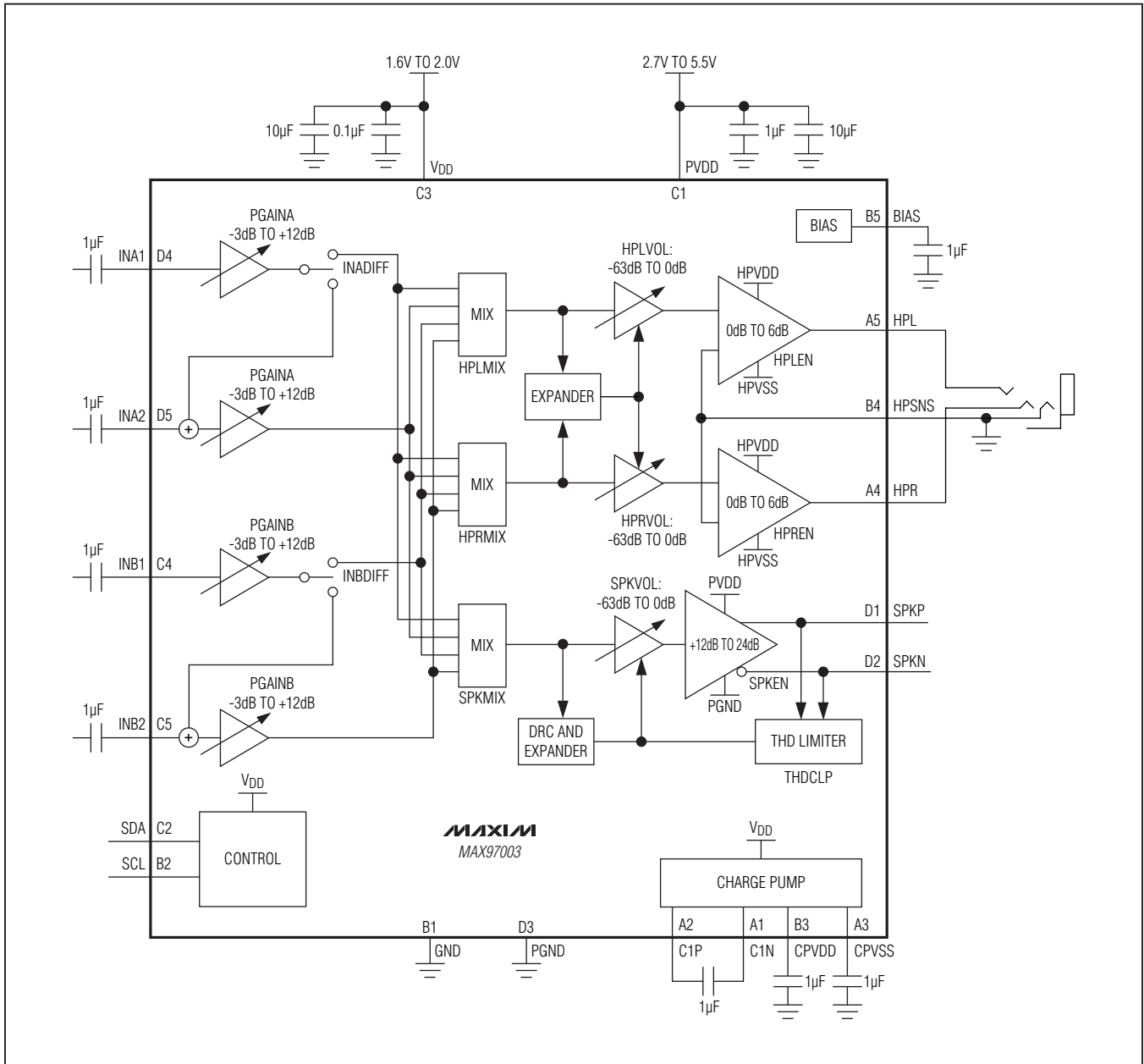

High-Efficiency, Low-Noise Audio Subsystem

ABSOLUTE MAXIMUM RATINGS

(Voltages with respect to GND.)

V _{DD} , CPVDD	-0.3V to +2.2V
BIAS	-0.3V to (V _{DD} + 0.3V)
PVDD	-0.3V to +6.0V
PGND	-0.1V to +0.1V
CPVSS	-2.2V to +0.3V
C1N	(V _{CPVSS} - 0.3V) to (V _{CPVDD} + 0.3V)
C1P	-0.3V to (V _{CPVDD} + 0.3V)
HPL, HPR	(V _{CPVSS} - 0.3V) to (V _{CPVDD} + 0.3V)
INA1, INA2, INB1, INB2	-0.3V to +6.0V
SDA, SCL	-0.3V to +6.0V
SPKP, SPKN	-0.3V to (V _{PVDD} + 0.3V)
HPSNS	-0.3V to +0.3V

Continuous Current In/Out of PVDD, PGND, SPK_	±800mA
Continuous Current In/Out of HPR, HPL, V _{DD}	±140mA
Continuous Input Current (all other pins)	±20mA
Duration of SPK_ Short Circuit to GND or PVDD	Continuous
Duration of Short Circuit Between SPKP and SPKN	Continuous
Duration of HP_ Short Circuit to GND or V _{DD}	Continuous
Continuous Power Dissipation (T _A = +70°C)	
WLP Multilayer Board	
(derate 21.7mW/°C above +70°C)	1.74W
Junction Temperature	+150°C
Operating Temperature Range	-40°C to +85°C
Storage Temperature Range	-65°C to +150°C
Soldering Temperature (reflow)	+260°C

Stresses beyond those listed under "Absolute Maximum Ratings" may cause permanent damage to the device. These are stress ratings only, and functional operation of the device at these or any other conditions beyond those indicated in the operational sections of the specifications is not implied. Exposure to absolute maximum rating conditions for extended periods may affect device reliability.

ELECTRICAL CHARACTERISTICS

(V_{DD} = 1.8V, V_{PVDD} = 4.2V, V_{GNND} = V_{PGND} = 0V. Headphone path: PGAIN₋ = -1.5dB, HP_VOL = 0dB, HPGAIN = +2dB, input signal configured single-ended. Speaker path: PGAIN₋ = 0dB, SPKVOL = 0dB, SPKGAIN = +12dB, input signal configured differential. Speaker loads (Z_{SPK}) connected between SPKP and SPKN. Headphone loads (R_{HP}) connected from HPL or HPR to GND. SDA and SCL pullup voltage = 1.8V. Z_{SPK} = ∞, R_{HP} = ∞. C_{C1P-C1N} = C_{CPVDD} = C_{CPVSS} = C_{BIAS} = 1μF. T_A = T_{MIN} to T_{MAX}, unless otherwise noted. Typical values are at T_A = +25°C.) (Note 1)

PARAMETER	SYMBOL	CONDITIONS	MIN	TYP	MAX	UNITS
Speaker Amplifier Supply Voltage Range	PVDD	Guaranteed by PSRR test	2.7		5.5	V
Headphone Amplifier Supply Voltage Range	V _{DD}	Guaranteed by PSRR test	1.6		2	V
Quiescent Current	I _{DD}	HP mode, T _A = +25°C, stereo SE input on INA routed to HP output, HP expander disabled	I _{VDD}	1.21	1.6	mA
			I _{PVDD}	1.07	1.3	
		HP mode, T _A = +25°C, stereo SE input on INA routed to HP output, HP expander enabled	I _{VDD}	2.46	2.95	
			I _{PVDD}	1.34	1.6	
		SPK mode, T _A = +25°C mono differential input on INA routed to SPK output; SPK expander, DRC, and limiter all disabled	I _{VDD}	0.1	0.15	
			I _{PVDD}	2.25	2.6	
		SPK mode, T _A = +25°C mono differential input on INA routed to SPK output; SPK expander, DRC, and limiter all enabled	I _{VDD}	1.35	1.65	
			I _{PVDD}	2.6	2.95	
		SPK + HP mode, T _A = +25°C stereo SE input on INA routed to HP and SPK output; SPK and HP expanders, DRC, and limiter all disabled	I _{VDD}	1.21	1.6	
			I _{PVDD}	2.74	3.2	

High-Efficiency, Low-Noise Audio Subsystem

ELECTRICAL CHARACTERISTICS (continued)

($V_{DD} = 1.8V$, $V_{PVDD} = 4.2V$, $V_{GND} = V_{PGND} = 0V$. Headphone path: $PGAIN_ = -1.5dB$, $HP_VOL = 0dB$, $HPGAIN = +2dB$, input signal configured single-ended. Speaker path: $PGAIN_ = 0dB$, $SPKVOL = 0dB$, $SPKGAIN = +12dB$, input signal configured differential. Speaker loads (Z_{SPK}) connected between $SPKP$ and $SPKN$. Headphone loads (R_{HP}) connected from HPL or HPR to GND . SDA and SCL pullup voltage = $1.8V$. $Z_{SPK} = \infty$, $R_{HP} = \infty$. $C_{C1P-C1N} = C_{CPVDD} = C_{CPVSS} = C_{BIAS} = 1\mu F$. $T_A = T_{MIN}$ to T_{MAX} , unless otherwise noted. Typical values are at $T_A = +25^\circ C$.) (Note 1)

PARAMETER	SYMBOL	CONDITIONS		MIN	TYP	MAX	UNITS
Shutdown Current	I_{SHDN}	I_{VDD} , $T_A = +25^\circ C$			0.08	2.5	μA
		I_{PVDD} , $T_A = +25^\circ C$			0.05	1	
Turn On-Time	t_{ON}	Time from power-on to full operation	$SLEW = 0$		17		ms
			$SLEW = 1$		10		
PREAMPLIFIERS							
Input Resistance	R_{IN}	$T_A = +25^\circ C$	-3dB to +9dB	15	20.4	28.5	$k\Omega$
			+10.5dB to +12dB	5.2	6.96	9.5	
Gain			$PGAIN_ = 0x0$	-3.2	-2.98	-2.79	dB
			$PGAIN_ = 0x1$		-1.49		
			$PGAIN_ = 0x2$	-0.22	-0.02	+0.21	
			$PGAIN_ = 0x3$		1.57		
			$PGAIN_ = 0x4$		3.04		
			$PGAIN_ = 0x5$		4.52		
			$PGAIN_ = 0x6$		6.06		
			$PGAIN_ = 0x7$		7.51		
			$PGAIN_ = 0x8$		9.01		
			$PGAIN_ = 0x9$		10.59		
		$PGAIN_ = 0xA$	11.82	12	12.36		
Maximum Input Signal Swing		Preamp = 0dB		2.4		V_{P-P}	
Common-Mode Rejection Ratio	CMRR	$f = 1kHz$ (differential input mode), 0dB		63		dB	
Input DC Voltage		$IN_$ inputs		1.2	1.23	1.275	V
Bias Voltage	V_{BIAS}			1.2	1.23	1.275	V
SPEAKER AMPLIFIER							
Output Offset Voltage	VOS	$T_A = +25^\circ C$ (volume at mute, $SPKGAIN = 00$)		± 0.5	± 2.5		mV
		$T_A = +25^\circ C$ (volume at 0dB, $SPKGAIN = 00$)		± 1.0			
Click-and-Pop Level	K_{CP}	Peak voltage, $T_A = +25^\circ C$, A-weighted, 32 samples per second, volume at 0dB, $SPKGAIN = 00$ (Note 2)	Into shutdown		-72		dBV
			Out of shutdown		-65		

High-Efficiency, Low-Noise Audio Subsystem

ELECTRICAL CHARACTERISTICS (continued)

($V_{DD} = 1.8V$, $V_{PVDD} = 4.2V$, $V_{GND} = V_{PGND} = 0V$. Headphone path: $PGAIN_{-} = -1.5dB$, $HP_VOL = 0dB$, $HPGAIN = +2dB$, input signal configured single-ended. Speaker path: $PGAIN_{-} = 0dB$, $SPKVOL = 0dB$, $SPKGAIN = +12dB$, input signal configured differential. Speaker loads (Z_{SPK}) connected between SPKP and SPKN. Headphone loads (R_{HP}) connected from HPL or HPR to GND. SDA and SCL pullup voltage = 1.8V. $Z_{SPK} = \infty$, $R_{HP} = \infty$. $C_{C1P-C1N} = C_{CPVDD} = C_{CPVSS} = C_{BIAS} = 1\mu F$. $T_A = T_{MIN}$ to T_{MAX} , unless otherwise noted. Typical values are at $T_A = +25^{\circ}C$.) (Note 1)

PARAMETER	SYMBOL	CONDITIONS		MIN	TYP	MAX	UNITS
Power-Supply Rejection Ratio (Note 2)	PSRR	$T_A = +25^{\circ}C$	$V_{PVDD} = 2.7V$ to $5.5V$	65	90.4		dB
			$f = 217Hz$, $V_{RIPPLE} = 200mV_{P-P}$		80		
			$f = 1kHz$, $V_{RIPPLE} = 200mV_{P-P}$		78		
			$f = 10kHz$, $V_{RIPPLE} = 200mV_{P-P}$		72		
Output Power (Note 3)	P_{OUT}	THD+N = 1%	$Z_{SPK} = 8\Omega + 68\mu H$, $V_{PVDD} = 4.2V$		1007		mW
			$Z_{SPK} = 8\Omega + 68\mu H$, $V_{PVDD} = 3.6V$		735		
			$Z_{SPK} = 4\Omega + 33\mu H$, $V_{PVDD} = 5.0V$		2585		
Total Harmonic Distortion Plus Noise	THD+N	$f = 1kHz$, $P_{OUT} = 700mW$, $T_A = +25^{\circ}C$, $Z_{SPK} = 8\Omega + 68\mu H$			0.06		%
			$f = 1kHz$, $P_{OUT} = 350mW$, $T_A = +25^{\circ}C$, $Z_{SPK} = 8\Omega + 68\mu H$		0.029	0.048	
Output Noise		A-weighted	Noise gate disabled		40		μV_{RMS}
			Noise gate enabled		25		
Signal-to-Noise Ratio	SNR	A-weighted, $P_{OUT} = 700mW$	Noise gate disabled		93		dB
			Noise gate enabled		98		
Output Frequency	f_{OSC}	Spread spectrum			298.9		kHz
Spread-Spectrum Bandwidth					± 10		kHz
Gain			SPKGAIN = 00		11.69		dB
			SPKGAIN = 01	15.4	15.65	15.92	
			SPKGAIN = 10		19.64		
			SPKGAIN = 11		23.7		
Current Limit					2		A
Efficiency	h	$P_{OUT} = 1W$, $f = 1kHz$, $Z_{SPK} = 8\Omega + 68\mu H$			92		%
Volume Control			SPKVOL = 0x00	-63.35	-62.87	-62.36	dB
			SPKVOL = 0x3F	-0.044	0	0.13	
Volume Control Step Size					1		dB
Mute Attenuation		$f = 1kHz$			118		dB

High-Efficiency, Low-Noise Audio Subsystem

ELECTRICAL CHARACTERISTICS (continued)

($V_{DD} = 1.8V$, $V_{PVDD} = 4.2V$, $V_{GND} = V_{PGND} = 0V$. Headphone path: $PGAIN_{-} = -1.5dB$, $HP_{-}VOL = 0dB$, $HPGAIN = +2dB$, input signal configured single-ended. Speaker path: $PGAIN_{-} = 0dB$, $SPKVOL = 0dB$, $SPKGAIN = +12dB$, input signal configured differential. Speaker loads (Z_{SPK}) connected between $SPKP$ and $SPKN$. Headphone loads (R_{HP}) connected from HPL or HPR to GND . SDA and SCL pullup voltage = $1.8V$. $Z_{SPK} = \infty$, $R_{HP} = \infty$. $C_{C1P-C1N} = C_{CPVDD} = C_{CPVSS} = C_{BIAS} = 1\mu F$. $T_A = T_{MIN}$ to T_{MAX} , unless otherwise noted. Typical values are at $T_A = +25^{\circ}C$.) (Note 1)

PARAMETER	SYMBOL	CONDITIONS	MIN	TYP	MAX	UNITS
CHARGE PUMP						
Charge-Pump Frequency		$V_{HPL} = V_{HPR} = 0V$	80	83.3	86	kHz
		$V_{HPL} = V_{HPR} = 0.2V$		665		
		$V_{HPL} = V_{HPR} = 0.5V$		500		
Positive Output Voltage	V_{CPVDD}	$V_{OUT} > V_{TH}$		V_{DD}		V
		$V_{OUT} < V_{TH}$		$V_{DD}/2$		
Negative Output Voltage	V_{CPVSS}	$V_{OUT} > V_{TH}$		$-V_{DD}$		V
		$V_{OUT} < V_{TH}$		$-V_{DD}/2$		
Output Voltage Threshold	V_{TH}	Output voltage at which the charge pump switches modes, V_{OUT} rising or falling	$\pm V_{DD} \times 0.216$	$\pm V_{DD} \times 0.25$	$\pm V_{DD} \times 0.278$	V
Mode Transition Timeouts		Time it takes for the charge pump to transition from invert to split mode		30		ms
		Time it takes for the charge pump to transition from split to invert mode		20		μs
HEADPHONE AMPLIFIERS						
Output Offset Voltage	VOS	$T_A = +25^{\circ}C$		± 0.15	± 0.5	mV
Click-and-Pop Level	K_{CP}	Peak voltage, $T_A = +25^{\circ}C$, A-weighted, 32 samples per second, volume at 0dB (Note 2)	Into shutdown		-73	dBV
			Out of shutdown		-73	
Power-Supply Rejection Ratio (Note 2)	PSRR	$T_A = +25^{\circ}C$	$V_{DD} = 1.6V$ to $2.0V$	65	99.9	dB
			$f = 217Hz$, $V_{RIPPLE} = 200mV_{P-P}$		93	
			$f = 1kHz$, $V_{RIPPLE} = 200mV_{P-P}$		88	
			$f = 20kHz$, $V_{RIPPLE} = 200mV_{P-P}$		65	

High-Efficiency, Low-Noise Audio Subsystem

ELECTRICAL CHARACTERISTICS (continued)

($V_{DD} = 1.8V$, $V_{PVDD} = 4.2V$, $V_{GND} = V_{PGND} = 0V$. Headphone path: $PGAIN_{-} = -1.5dB$, $HP_VOL = 0dB$, $HPGAIN = +2dB$, input signal configured single-ended. Speaker path: $PGAIN_{-} = 0dB$, $SPKVOL = 0dB$, $SPKGAIN = +12dB$, input signal configured differential. Speaker loads (Z_{SPK}) connected between $SPKP$ and $SPKN$. Headphone loads (R_{HP}) connected from HPL or HPR to GND . SDA and SCL pullup voltage = $1.8V$. $Z_{SPK} = \infty$, $R_{HP} = \infty$. $C_{C1P-C1N} = C_{CPVDD} = C_{CPVSS} = C_{BIAS} = 1\mu F$. $T_A = T_{MIN}$ to T_{MAX} , unless otherwise noted. Typical values are at $T_A = +25^{\circ}C$.) (Note 1)

PARAMETER	SYMBOL	CONDITIONS		MIN	TYP	MAX	UNITS
Output Power	P_{OUT}	THD+N = 1%, PGAINA = -1.5dB, HPGAIN = +2dB	$R_{HP} = 16\Omega$		42		mW
			$R_{HP} = 32\Omega$		32		
		THD+N = 0.1%, PGAINA = -1.5dB, HPGAIN = +2dB	$R_{HP} = 32\Omega$		27		
Channel-to-Channel Gain Tracking		HPL to HPR, volume at 0dB, HPLMIX = 0x1, HPRMIX = 0x2, IN_DIFF = 0			0.25	1.5	%
Total Harmonic Distortion Plus Noise	THD+N	$R_{HP} = 32\Omega$, $P_{OUT} = 10mW$, $f = 1kHz$			0.005		%
		$R_{HP} = 16\Omega$, $P_{OUT} = 10mW$, $f = 1kHz$			0.006		
Output Noise		A-weighted	Noise gate disabled		10		μV_{RMS}
			Noise gate enabled		5.9		
Signal-to-Noise Ratio	SNR	A-weighted, $P_{OUT} = 10mW$	Noise gate disabled		94.2		dB
			Noise gate enabled		96.4		
Capacitive Drive	C_L				1000		pF
Crosstalk		HPL to HPR, HPR to HPL, $R_{HP} = 32\Omega$, $P_{OUT} = 10mW$	$f = 20Hz$ to $10kHz$		-78		dB
			$f = 1kHz$		-83		
Gain		HPGAIN = 00		-0.53	-0.25	+0.09	dB
		HPGAIN = 01			1.72		
		HPGAIN = 10			3.72		
		HPGAIN = 11			5.85		
Volume Control		HP_VOL = 0x00		-63.74	-63.3	-62.9	dB
		HP_VOL = 0x3F		-0.50	-0.27	+0.09	
Volume Control Step Size					1		dB
Mute Attenuation		$f = 1kHz$			100		dB
SPEAKER DRC							
Release Time		DRCRLS = 000			800		ms/step
		DRCRLS = 101			25		
Attack Time		DRCATK = 000			0.5		ms
		DRCATK = 111			50		
Compression Ratio		DRCEN = 001			1.34:1		ratio
		DRCEN = 101			∞ :1		

High-Efficiency, Low-Noise Audio Subsystem

ELECTRICAL CHARACTERISTICS (continued)

($V_{DD} = 1.8V$, $V_{PVDD} = 4.2V$, $V_{GND} = V_{PGND} = 0V$. Headphone path: $PGAIN_ = -1.5dB$, $HP_VOL = 0dB$, $HPGAIN = +2dB$, input signal configured single-ended. Speaker path: $PGAIN_ = 0dB$, $SPKVOL = 0dB$, $SPKGAIN = +12dB$, input signal configured differential. Speaker loads (Z_{SPK}) connected between $SPKP$ and $SPKN$. Headphone loads (R_{HP}) connected from HPL or HPR to GND . SDA and SCL pullup voltage = $1.8V$. $Z_{SPK} = \infty$, $R_{HP} = \infty$. $C_{C1P-C1N} = C_{CPVDD} = C_{CPVSS} = C_{BIAS} = 1\mu F$. $T_A = T_{MIN}$ to T_{MAX} , unless otherwise noted. Typical values are at $T_A = +25^\circ C$.) (Note 1)

PARAMETER	SYMBOL	CONDITIONS	MIN	TYP	MAX	UNITS
Compression Threshold		DRCTH = 0x01		0.839		V_{RMS}
		DRCTH = 0x1F		0.199		
SPEAKER AND HEADPHONE EXPANDER						
Attack Time		High signal to low signal transition	EXP_ATK = 000		500	ms/step
			EXP_ATK = 101		25	
			EXP_ATK = 110		15	
Release Time		Low-signal to high-signal transition		0.2		ms/step
Expander Threshold		EXP_TH = 0x1		32		mVp
		EXP_TH = 0xF		1		
SPEAKER DISTORTION LIMITER						
Distortion Threshold		THDCLP = 0x1		< 1		%
		THDCLP = 0xF		24		
Attack Time				0.5		ms
Release Time		THDRLS = 000		0.076		s
		THDRLS = 111		6.2		

DIGITAL I/O CHARACTERISTICS

($V_{DD} = 1.8V$, $V_{PVDD} = 4.2V$, $V_{GND} = V_{PGND} = 0V$. $T_A = T_{MIN}$ to T_{MAX} , unless otherwise noted. Typical values are at $T_A = +25^\circ C$.) (Note 1)

PARAMETER	SYMBOL	CONDITIONS	MIN	TYP	MAX	UNITS
DIGITAL INPUTS (SDA and SCL)						
Input Voltage High	V_{iH}		0.7 x V_{DD}			V
Input Voltage Low	V_{iL}				0.4 x V_{DD}	V
Input Hysteresis	V_{HYS}			200		mV
Input Capacitance	C_{IN}			10		pF
Input Leakage Current	I_{IN}	$T_A = +25^\circ C$			± 1.0	μA
Input Leakage Current	I_{IN}	$V_{DD} = 0V$, $T_A = +25^\circ C$			± 1.0	μA
DIGITAL OUTPUTS (SDA Open Drain)						
Output Low Voltage SDA	V_{OL}	$I_{SINK} = 3mA$			0.4	V

High-Efficiency, Low-Noise Audio Subsystem

I²C TIMING CHARACTERISTICS

(V_{DD} = 1.8V, V_{PVDD} = 4.2V, V_{GND} = V_{PGND} = 0V. T_A = T_{MIN} to T_{MAX}, unless otherwise noted. Typical values are at T_A = +25°C.) (Note 1)

PARAMETER	SYMBOL	CONDITIONS	MIN	TYP	MAX	UNITS
Serial-Clock Frequency	f _{SCL}		0		400	kHz
Bus Free Time Between STOP and START Conditions	t _{BUF}		1.3			μs
Hold Time (Repeated) START Condition	t _{HD,STA}		0.6			μs
SCL Pulse-Width Low	t _{LOW}		1.3			μs
SCL Pulse-Width High	t _{HIGH}		0.6			μs
Setup Time for a Repeated START Condition	t _{SU,STA}		0.6			μs
Data Hold Time	t _{HD,DAT}		0		900	ns
Data Setup Time	t _{SU,DAT}		100			ns
SDA and SCL Receiving Rise Time	t _R	(Note 4)	20 + 0.1C _B			ns
SDA and SCL Receiving Fall Time	t _F	(Note 4)	20 + 0.1C _B		300	ns
SDA Transmitting Fall Time	t _F	(Note 4)	20 + 0.1C _B		250	ns
Setup Time for STOP Condition	t _{SU,STO}		0.6			μs
Bus Capacitance	C _B				400	pF
Pulse Width of Suppressed Spike	t _{SP}		0		50	ns

Note 1: 100% production tested at T_A = +25°C. Specifications over temperature limits are guaranteed by design.

Note 2: Amplifier inputs are AC-coupled to GND.

Note 3: Class D amplifier testing performed with a resistive load in series with an inductor to simulate an actual speaker load.

Note 4: C_B is in pF.

High-Efficiency, Low-Noise Audio Subsystem

Typical Operating Characteristics

($V_{DD} = 1.8V$, $V_{PVDD} = 4.2V$, $V_{GND} = V_{PGND} = 0V$. Headphone path: $PGAIN_- = -1.5dB$, $HP_VOL = 0dB$, $HPGAIN = +2dB$, input signal configured single-ended. Speaker path: $PGAIN_- = 0dB$, $SPKVOL = 0dB$, $SPKGAIN = +12dB$, input signal configured differential. Speaker loads (Z_{SPK}) connected between $SPKP$ and $SPKN$. Headphone loads (R_{HP}) connected from HPL or HPR to GND . SDA and SCL pullup voltage = $1.8V$. $Z_{SPK} = \infty$, $R_{HP} = \infty$. $C_{C1P-C1N} = C_{CPVDD} = C_{CPVSS} = C_{BIAS} = 1\mu F$.)

GENERAL

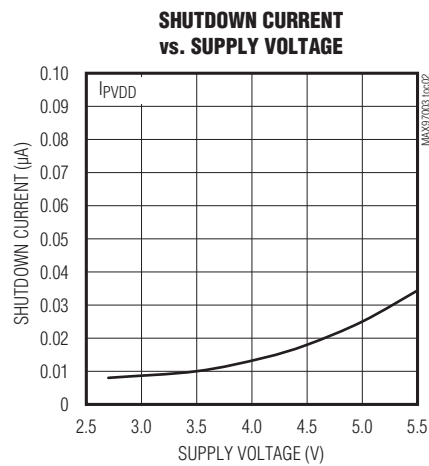
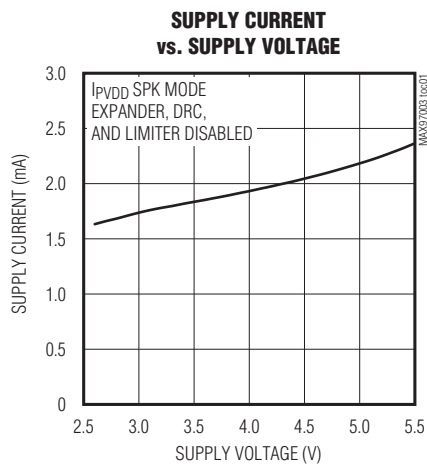

SPEAKER AMPLIFIER

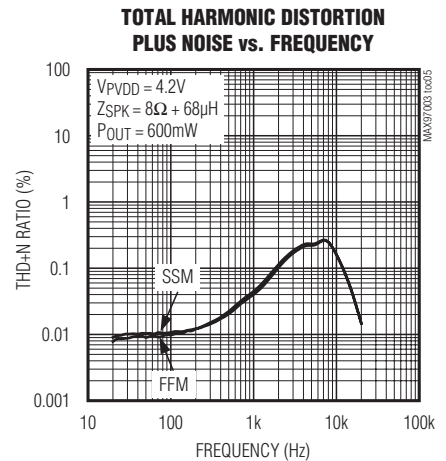
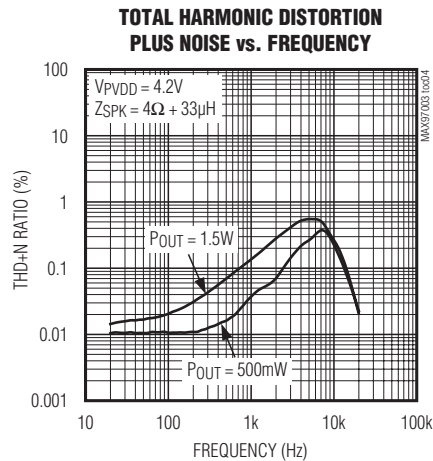
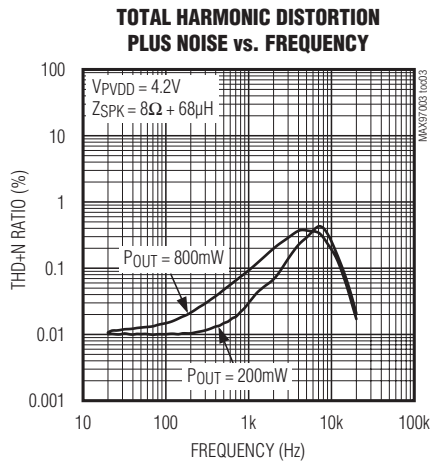

High-Efficiency, Low-Noise Audio Subsystem

Typical Operating Characteristics (continued)

($V_{DD} = 1.8V$, $V_{PVDD} = 4.2V$, $V_{GND} = V_{PGND} = 0V$. Headphone path: $PGAIN_{-} = -1.5dB$, $HP_VOL = 0dB$, $HPGAIN = +2dB$, input signal configured single-ended. Speaker path: $PGAIN_{-} = 0dB$, $SPKVOL = 0dB$, $SPKGAIN = +12dB$, input signal configured differential. Speaker loads (Z_{SPK}) connected between SPKP and SPKN. Headphone loads (R_{HP}) connected from HPL or HPR to GND. SDA and SCL pullup voltage = 1.8V. $Z_{SPK} = \infty$, $R_{HP} = \infty$. $C_{C1P-C1N} = C_{CPVDD} = C_{CPVSS} = C_{BIAS} = 1\mu F$.)

SPEAKER AMPLIFIER

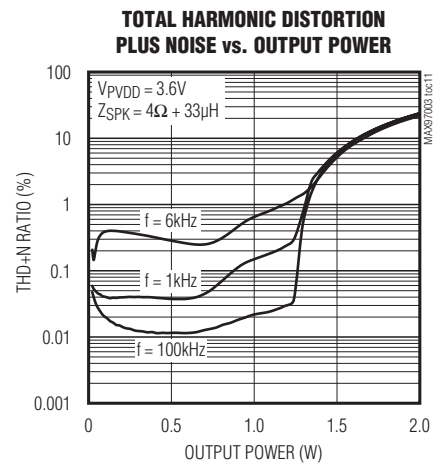
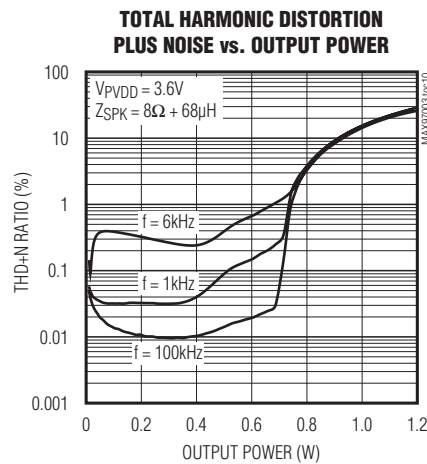
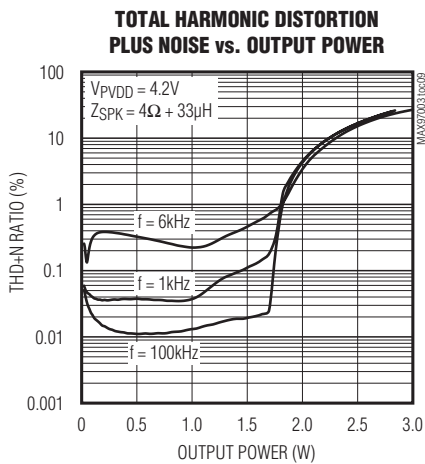
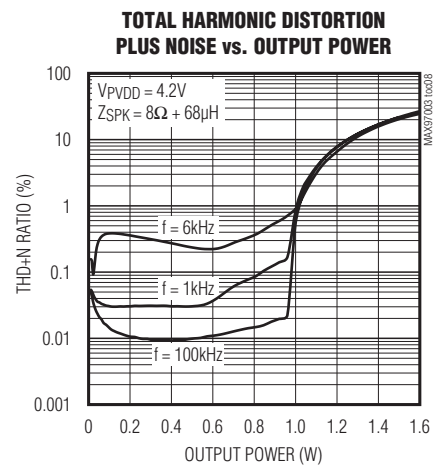
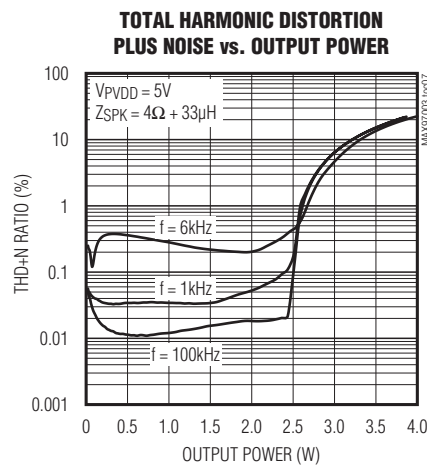
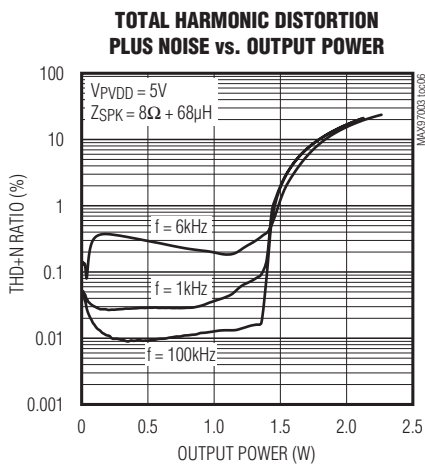

High-Efficiency, Low-Noise Audio Subsystem

Typical Operating Characteristics (continued)

($V_{DD} = 1.8V$, $V_{PVDD} = 4.2V$, $V_{GND} = V_{PGND} = 0V$. Headphone path: $PGAIN_- = -1.5dB$, $HP_VOL = 0dB$, $HPGAIN = +2dB$, input signal configured singled-ended. Speaker path: $PGAIN_- = 0dB$, $SPKVOL = 0dB$, $SPKGAIN = +12dB$, input signal configured differential. Speaker loads (Z_{SPK}) connected between SPKP and SPKN. Headphone loads (R_{HP}) connected from HPL or HPR to GND. SDA and SCL pullup voltage = 1.8V. $Z_{SPK} = \infty$, $R_{HP} = \infty$. $C_{C1P-C1N} = C_{CPVDD} = C_{CPVSS} = C_{BIAS} = 1\mu F$.)

SPEAKER AMPLIFIER

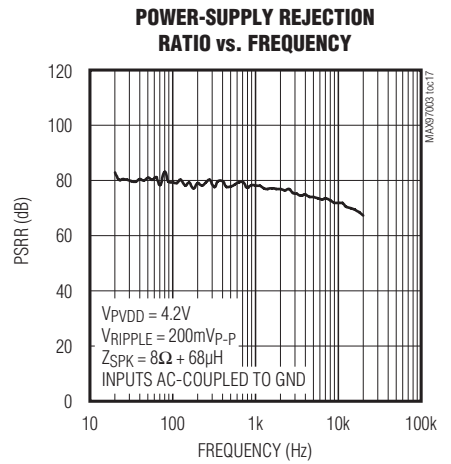
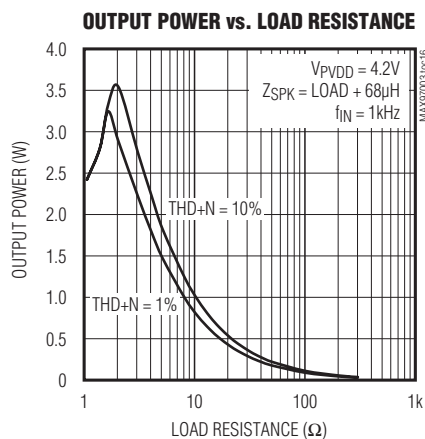
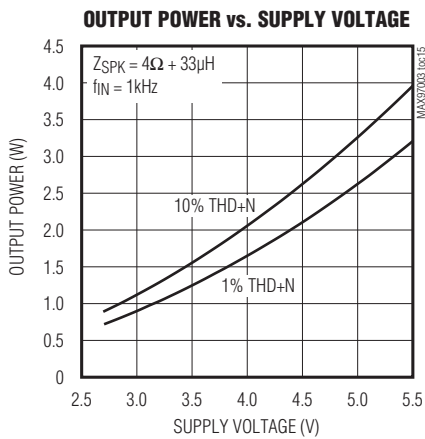
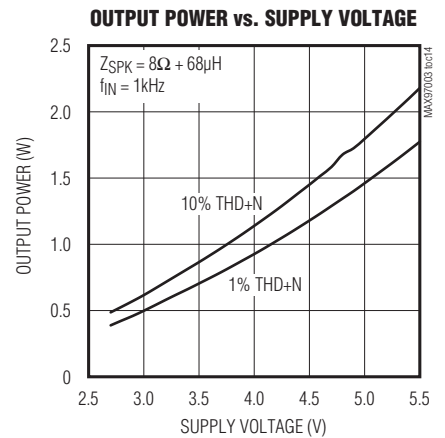
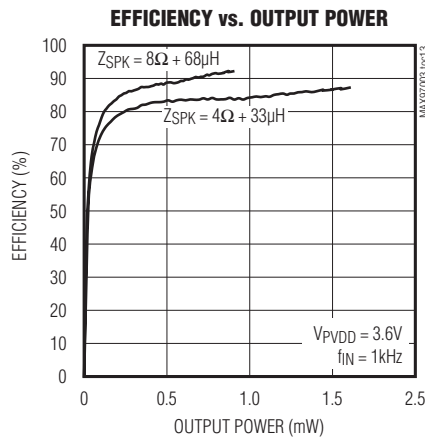
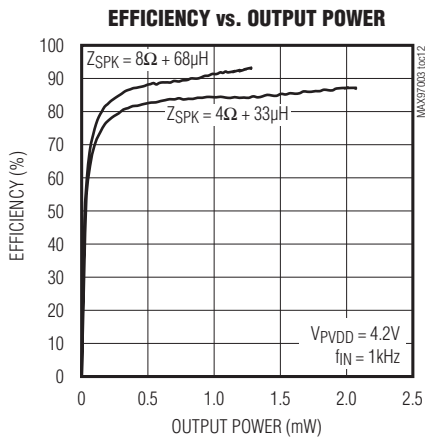

High-Efficiency, Low-Noise Audio Subsystem

Typical Operating Characteristics (continued)

($V_{DD} = 1.8V$, $V_{PVDD} = 4.2V$, $V_{GND} = V_{PGND} = 0V$. Headphone path: $PGAIN_- = -1.5dB$, $HP_VOL = 0dB$, $HPGAIN = +2dB$, input signal configured singled-ended. Speaker path: $PGAIN_- = 0dB$, $SPKVOL = 0dB$, $SPKGAIN = +12dB$, input signal configured differential. Speaker loads (Z_{SPK}) connected between $SPKP$ and $SPKN$. Headphone loads (R_{HP}) connected from HPL or HPR to GND . SDA and SCL pullup voltage = $1.8V$. $Z_{SPK} = \infty$, $R_{HP} = \infty$. $C_{C1P-C1N} = C_{CPVDD} = C_{CPVSS} = C_{BIAS} = 1\mu F$.)

SPEAKER AMPLIFIER

POWER-SUPPLY REJECTION RATIO vs. SUPPLY VOLTAGE

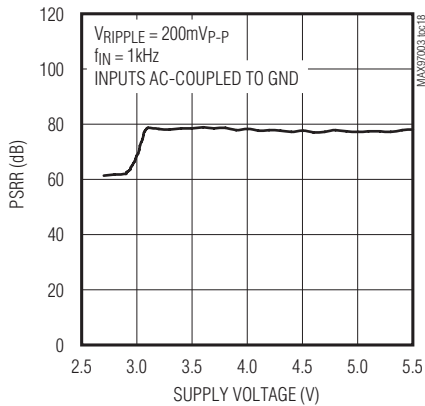

INBAND OUTPUT SPECTRUM

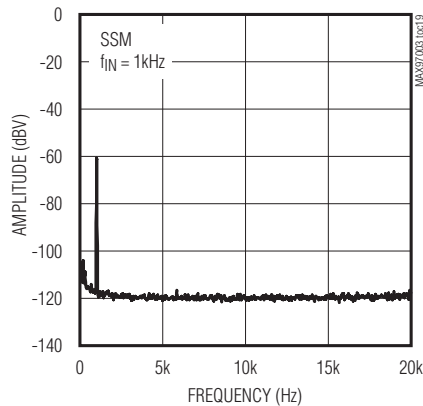

INBAND OUTPUT SPECTRUM

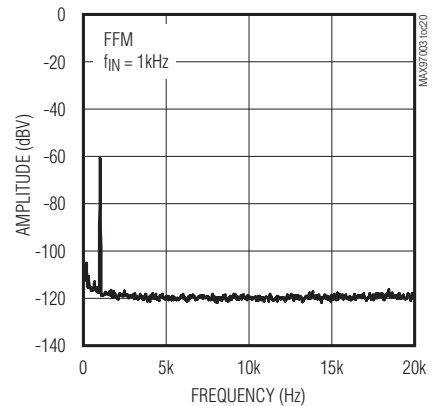

WIDEBAND OUTPUT SPECTRUM

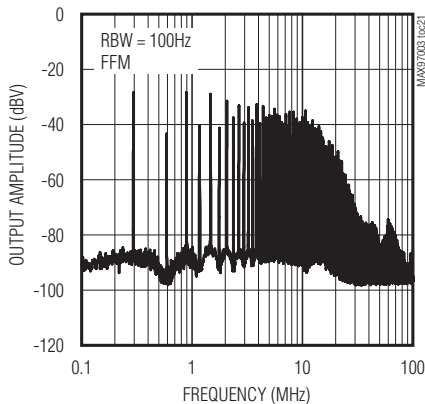

WIDEBAND OUTPUT SPECTRUM

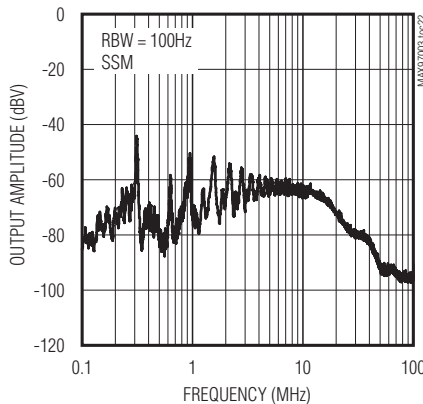

SPEAKER VOLUME GAIN vs. SPKVOL CODE

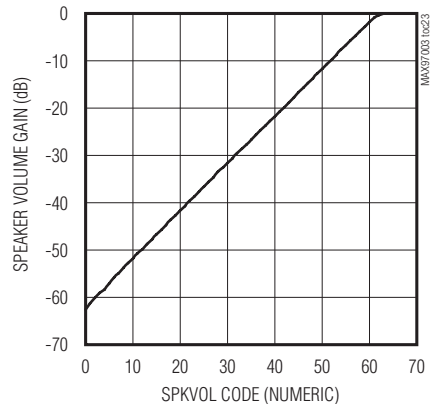

High-Efficiency, Low-Noise Audio Subsystem

Typical Operating Characteristics (continued)

($V_{DD} = 1.8V$, $V_{PVDD} = 4.2V$, $V_{GND} = V_{PGND} = 0V$. Headphone path: $PGAIN_- = -1.5dB$, $HP_VOL = 0dB$, $HPGAIN = +2dB$, input signal configured single-ended. Speaker path: $PGAIN_- = 0dB$, $SPKVOL = 0dB$, $SPKGAIN = +12dB$, input signal configured differential. Speaker loads (Z_{SPK}) connected between SPKP and SPKN. Headphone loads (R_{HP}) connected from HPL or HPR to GND. SDA and SCL pullup voltage = 1.8V. $Z_{SPK} = \infty$, $R_{HP} = \infty$. $C_{C1P-C1N} = C_{CPVDD} = C_{CPVSS} = C_{BIAS} = 1\mu F$.)

SPEAKER AMPLIFIER

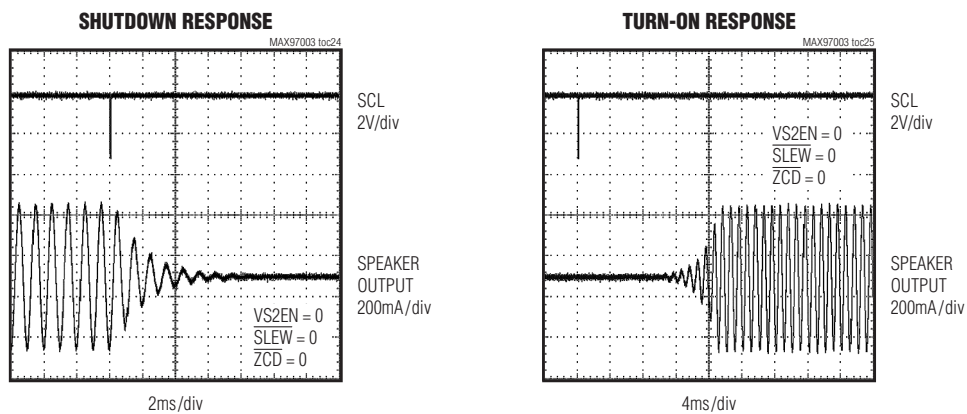

HEADPHONE AMPLIFIER

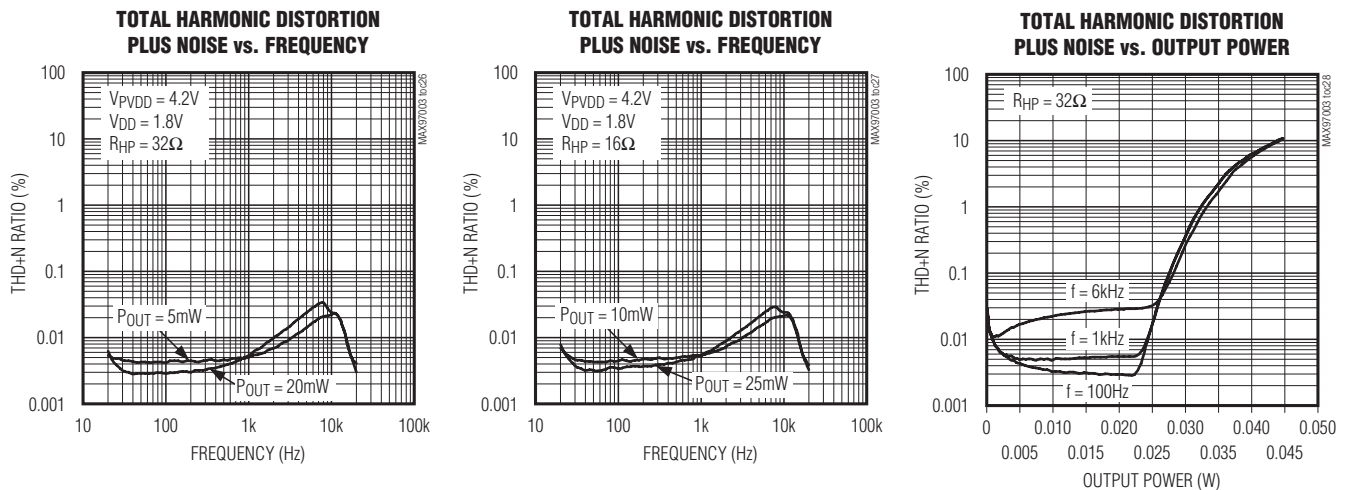

High-Efficiency, Low-Noise Audio Subsystem

Typical Operating Characteristics (continued)

($V_{DD} = 1.8V$, $V_{PVDD} = 4.2V$, $V_{GND} = V_{PGND} = 0V$. Headphone path: $PGAIN_- = -1.5dB$, $HP_VOL = 0dB$, $HPGAIN = +2dB$, input signal configured single-ended. Speaker path: $PGAIN_- = 0dB$, $SPKVOL = 0dB$, $SPKGAIN = +12dB$, input signal configured differential. Speaker loads (Z_{SPK}) connected between $SPKP$ and $SPKN$. Headphone loads (R_{HP}) connected from HPL or HPR to GND . SDA and SCL pullup voltage = $1.8V$. $Z_{SPK} = \infty$, $R_{HP} = \infty$. $C_{C1P-C1N} = C_{CPVDD} = C_{CPVSS} = C_{BIAS} = 1\mu F$.)

HEADPHONE AMPLIFIER

TOTAL HARMONIC DISTORTION PLUS NOISE vs. OUTPUT POWER

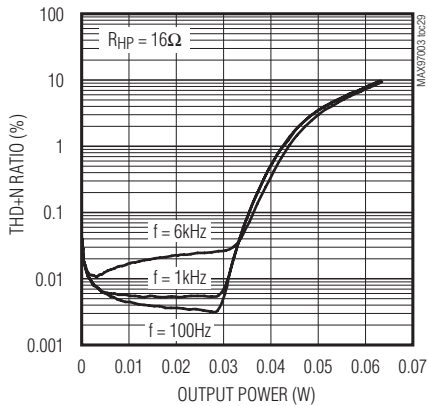

POWER DISSIPATION vs. OUTPUT POWER

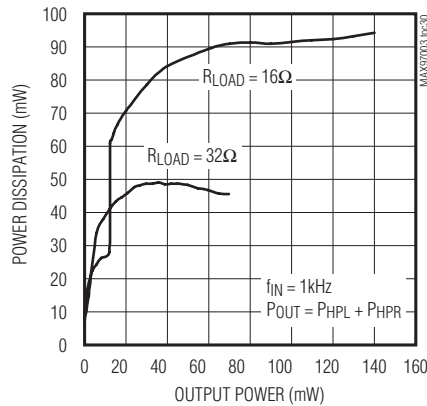

OUTPUT POWER vs. LOAD RESISTANCE

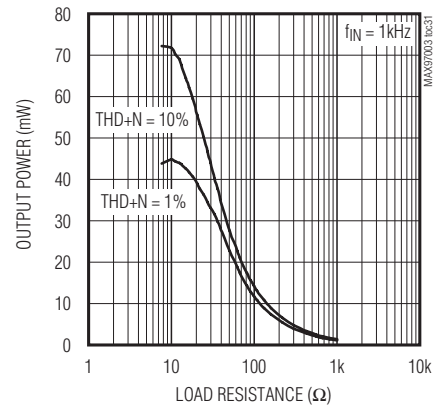

OUTPUT POWER vs. LOAD RESISTANCE AND CHARGE-PUMP CAPACITANCE

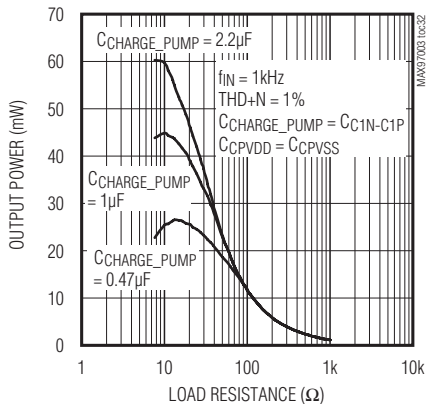

POWER-SUPPLY REJECTION RATIO vs. FREQUENCY

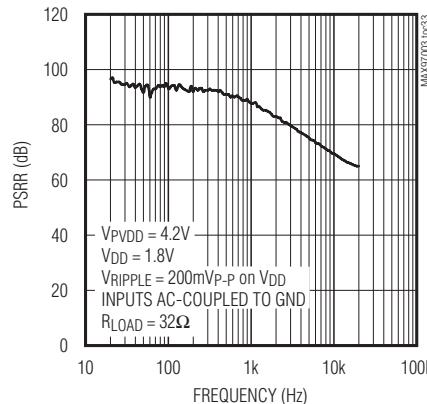

INBAND OUTPUT SPECTRUM

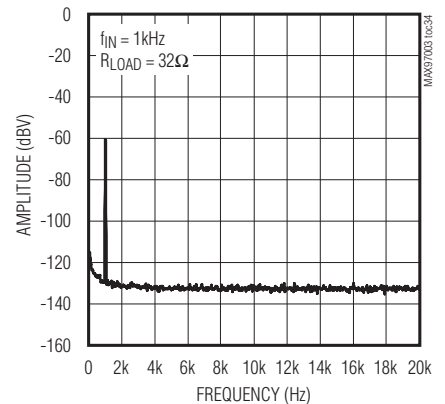

High-Efficiency, Low-Noise Audio Subsystem

Typical Operating Characteristics (continued)

($V_{DD} = 1.8V$, $V_{PVDD} = 4.2V$, $V_{GND} = V_{PGND} = 0V$. Headphone path: $PGAIN_- = -1.5dB$, $HP_VOL = 0dB$, $HPGAIN = +2dB$, input signal configured single-ended. Speaker path: $PGAIN_- = 0dB$, $SPKVOL = 0dB$, $SPKGAIN = +12dB$, input signal configured differential. Speaker loads (Z_{SPK}) connected between $SPKP$ and $SPKN$. Headphone loads (R_{HP}) connected from HPL or HPR to GND . SDA and SCL pullup voltage = $1.8V$. $Z_{SPK} = \infty$, $R_{HP} = \infty$. $C_{C1P-C1N} = C_{CPVDD} = C_{CPVSS} = C_{BIAS} = 1\mu F$.)

HEADPHONE AMPLIFIER

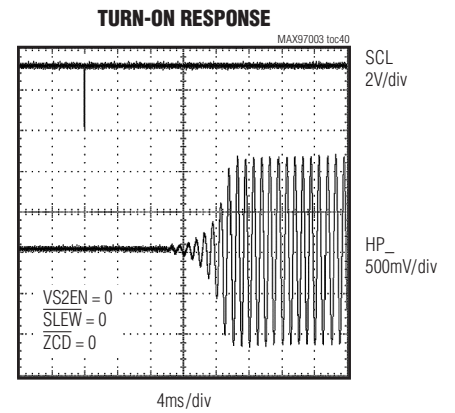
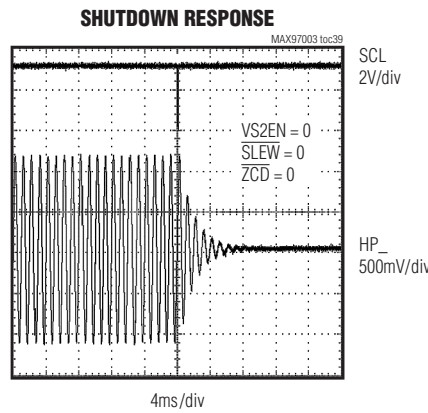
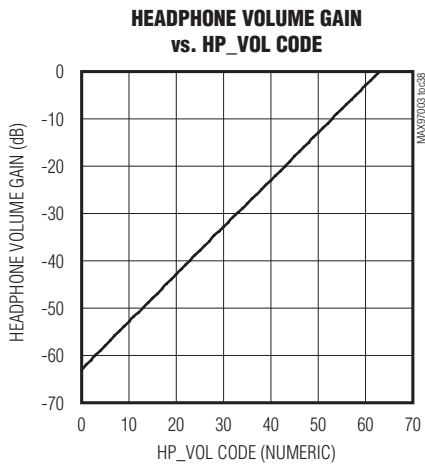
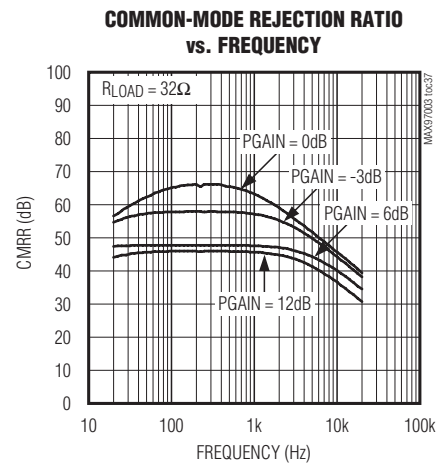
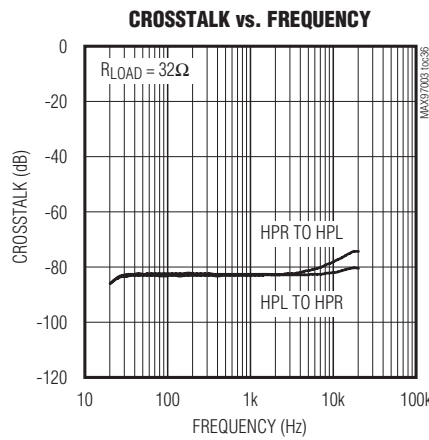
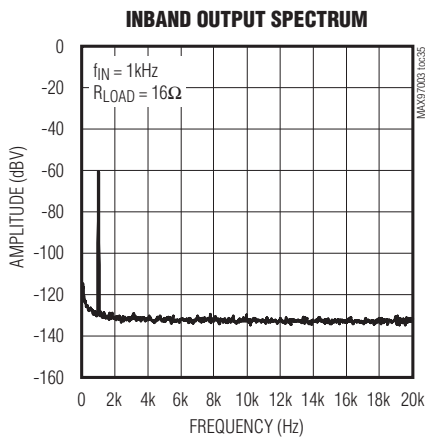

High-Efficiency, Low-Noise Audio Subsystem

Bump Configuration

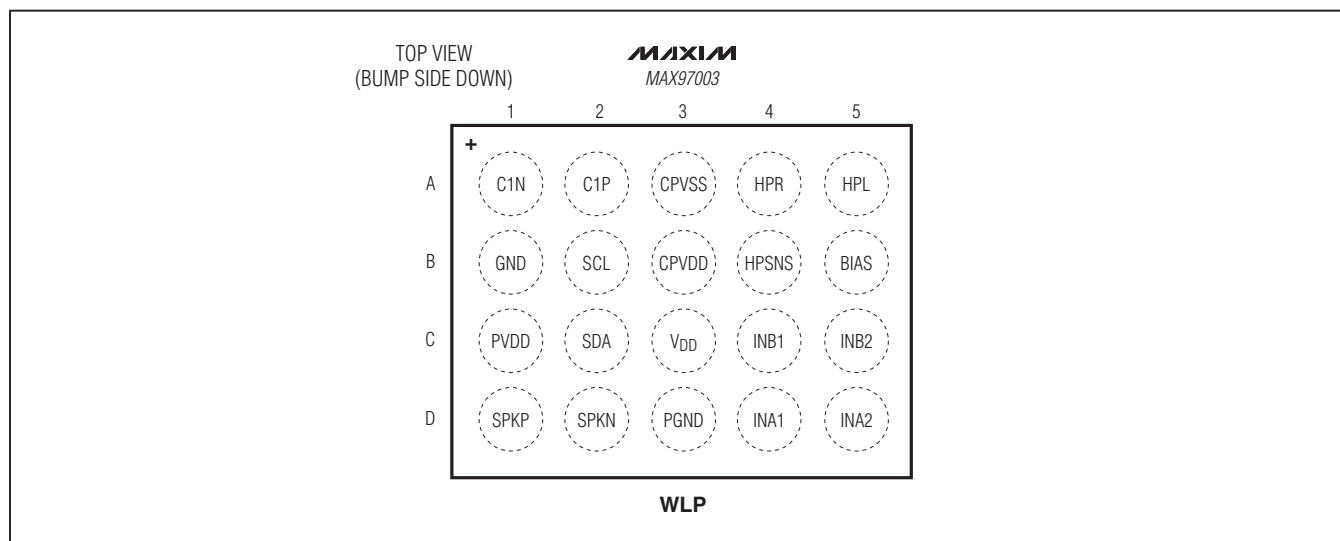

Bump Description

BUMP	NAME	FUNCTION
A1	C1N	Charge-Pump Flying Capacitor Negative Terminal. Connect a 1 μ F capacitor between C1P and C1N.
A2	C1P	Charge-Pump Flying Capacitor Positive Terminal. Connect a 1 μ F capacitor between C1P and C1N.
A3	CPVSS	Headphone Amplifier Negative Power Supply. Bypass with a 1 μ F capacitor to PGND.
A4	HPR	Headphone Amplifier Right Output
A5	HPL	Headphone Amplifier Left Output
B1	GND	Analog Ground
B2	SCL	Serial Clock Input. Connect a pullup resistor from SCL to the I ² C bus supply.
B3	CPVDD	Headphone Amplifier Positive Power Supply. Bypass with a 1 μ F capacitor to PGND.
B4	HPSNS	Headphone Ground Sense. Connect to the headset jack's ground terminal.
B5	BIAS	Common-Mode Bias. Bypass to GND with a 1 μ F capacitor.
C1	PVDD	Speaker Amplifier Power Supply. Bypass with a 0.1 μ F and a 10 μ F capacitor to PGND.
C2	SDA	Serial-Data Input/Output. Connect a pullup resistor from SDA to the I ² C bus supply.
C3	V _{DD}	Headphone Amplifier Supply. Bypass with a 0.1 μ F and a 10 μ F capacitor to GND.
C4	INB1	Input B1. Left or negative input.
C5	INB2	Input B2. Right or positive input.
D1	SPKP	Positive Speaker Output
D2	SPKN	Negative Speaker Output
D3	PGND	Speaker Amplifier Ground and Charge-Pump Ground
D4	INA1	Input A1. Left or negative input.
D5	INA2	Input A2. Right or positive input.

High-Efficiency, Low-Noise Audio Subsystem

Detailed Description

The MAX97003 audio subsystem combines a mono speaker amplifier with a stereo headphone amplifier. The high-efficiency 1W class D speaker amplifier operates directly from a lithium-ion battery and consumes no more than 0.05μA when in shutdown mode. The headphone amplifier utilizes a dual-mode charge pump and a Class H output stage to maximize efficiency while outputting a ground-referenced signal that does not require output coupling capacitors. The headphone and speaker amplifiers have independent volume and on/off control. The four inputs are configurable as two differential inputs or four single-ended inputs. All control is performed using the two-wire I²C interface.

The speaker amplifier incorporates a distortion limiter to automatically reduce the volume level when excessive clipping occurs. This allows high gain for low-level signals without compromising the quality of large signals. The speaker amplifier also features an adjustable DRC that provides programmable compression or limiting of the audio signal. Both the headphone and speaker

amplifiers feature a downward expander/noise gate to attenuate noise when no input signal is present. The headphone amplifier features a ground-sense pin to eliminate ground loop noise when the headphone jack is in use.

Signal Path

The signal path consists of flexible inputs, signal mixing, volume control, and output amplifiers (Figure 1). The inputs can be configured for single-ended or differential signals (Figure 2). The internal preamplifiers feature programmable gain settings using internal resistors. Following preamplification, the input signals are mixed, volume adjusted, and routed to the headphone and speaker amplifiers based on the desired configuration.

Class D Speaker Amplifier

The Class D speaker amplifier utilizes active emissions-limiting and spread-spectrum modulation to minimize the EMI radiated by the amplifier.

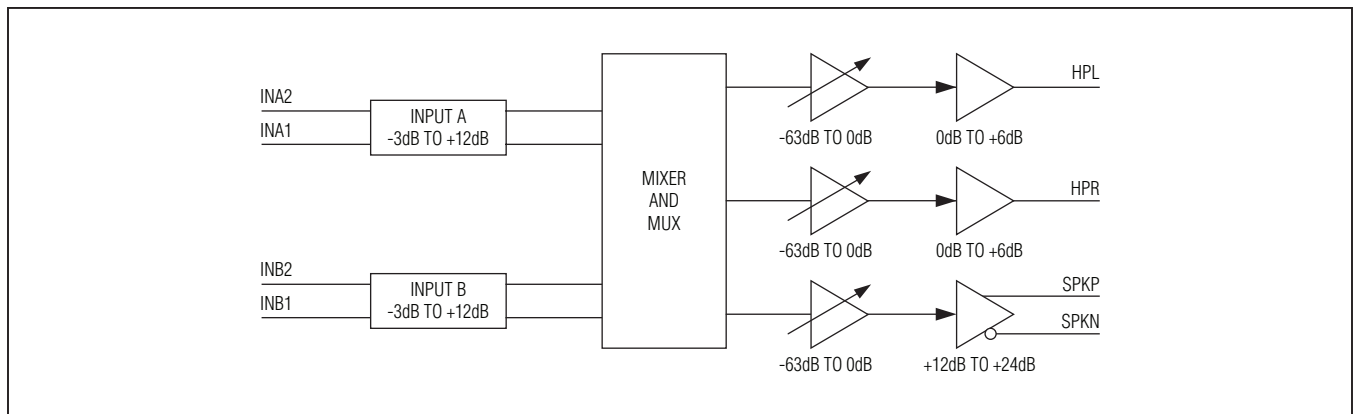

Figure 1. Signal Path

High-Efficiency, Low-Noise Audio Subsystem

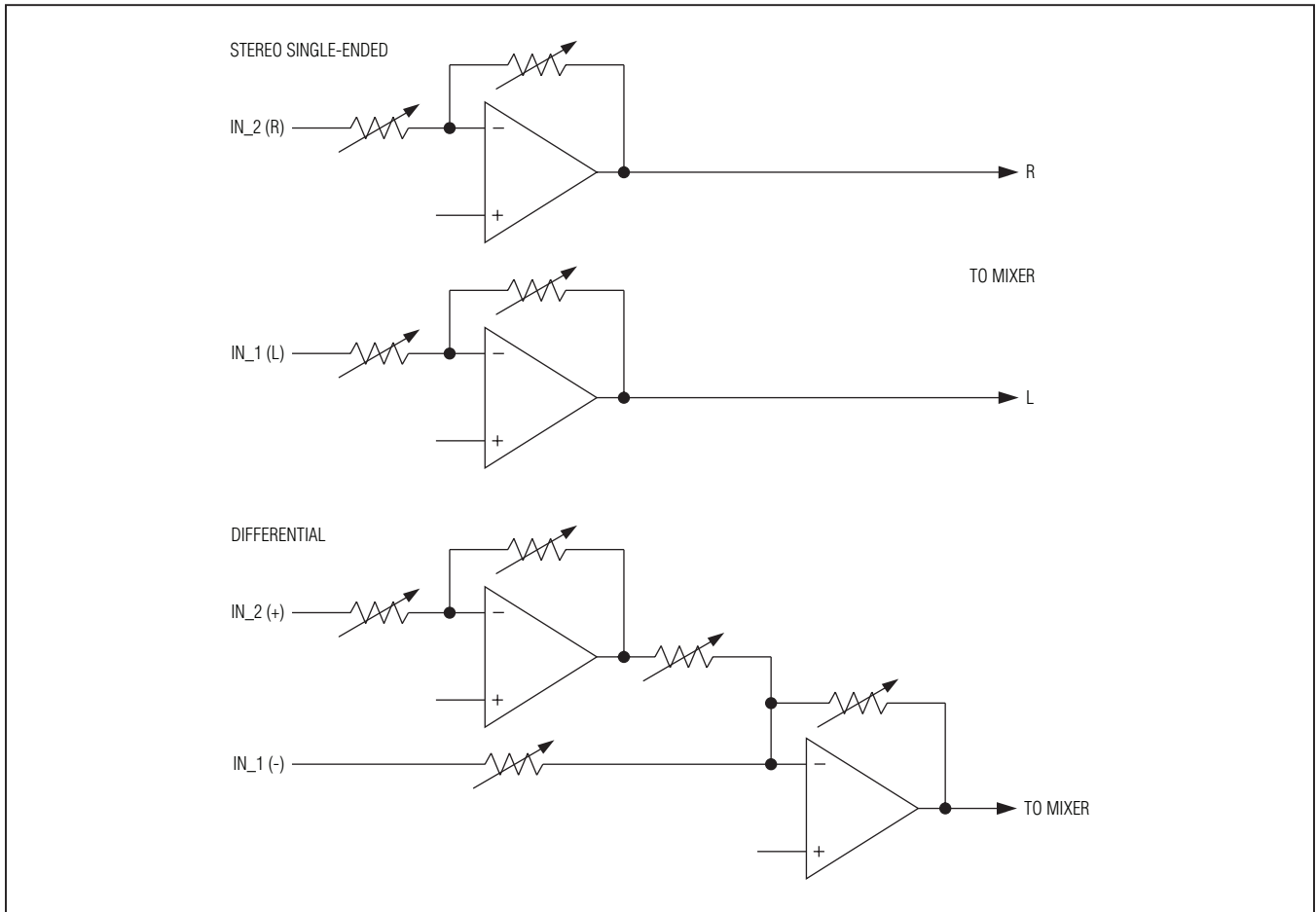

Figure 2. Stereo Single-Ended and Differential Input Configurations

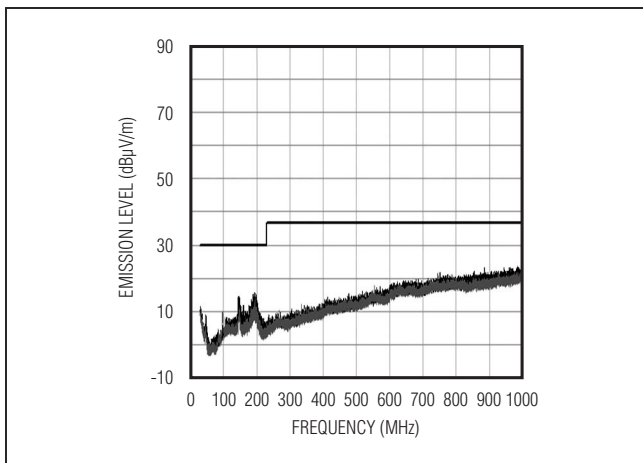

Figure 3. EMI with 12in of Speaker Cable

Ultra-Low EMI Filterless Output Stage

Traditional Class D amplifiers require the use of external LC filters or shielding to meet EN55022B electromagnetic-interference (EMI) regulation standards. Maxim's patented active emissions limiting edge-rate control circuitry and spread-spectrum modulation reduces EMI emissions, while maintaining up to 93% efficiency. Maxim's spread-spectrum modulation mode flattens wideband spectral components, while proprietary techniques ensure that the cycle-to-cycle variation of the switching period does not degrade audio reproduction or efficiency. The IC's spread-spectrum modulator randomly varies the switching frequency by $\pm 10\text{kHz}$ around the center frequency (300kHz). Above 10MHz, the wideband spectrum looks like noise for EMI purposes. See [Figure 3](#).

High-Efficiency, Low-Noise Audio Subsystem

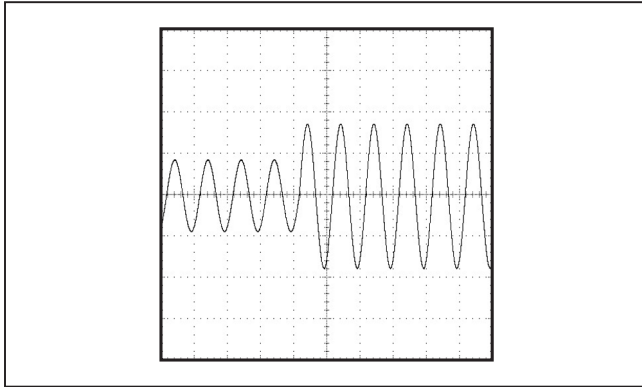

Figure 4. Low-Signal to High-Signal Transition, No Clipping, DRC Disabled

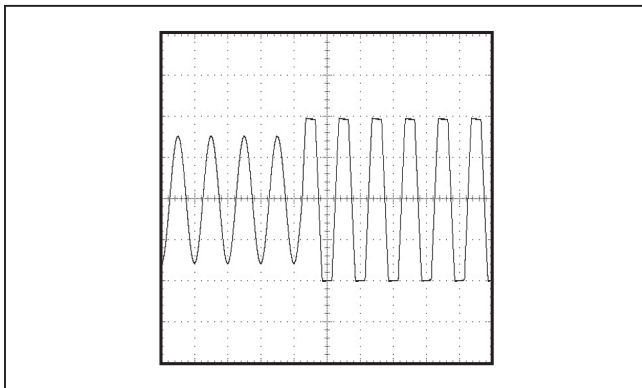

Figure 5. Low-Signal to High-Signal Transition, Increased Gain, DRC Disabled

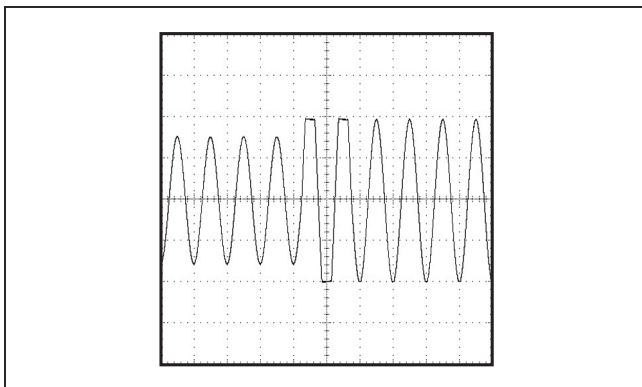

Figure 6. Low-Signal to High-Signal Transition, Increased Gain, DRC Enabled

Dynamic Range Compressor (DRC)

The speaker amplifier features a dynamic range compressor (DRC) that attenuates high-amplitude signals and allows for a higher gain setting to be selected without clipping the output signal. This increases the perceived loudness of the audio signal and maintains a stable output amplitude despite changes in input amplitude. [Figure 4](#), [Figure 5](#), and [Figure 6](#) demonstrate the benefits of using the DRC. Each of these figures uses the same input signal.

To operate the DRC, select a threshold level, compression ratio, attack time constant, and release time through registers 0x0A and 0x0B. When enabled, RMS signal levels that cross above the selected DRC threshold level are attenuated based on the selected compression ratio ([Figure 7](#)). Attenuation is achieved by automatically modifying the speaker volume to a lower gain setting. The user-selected gain setting is automatically restored when the RMS signal level falls below the DRC threshold. The attack time constant determines the time constant used when the DRC engages. The release time determines the time-per-step used when the DRC disengages.

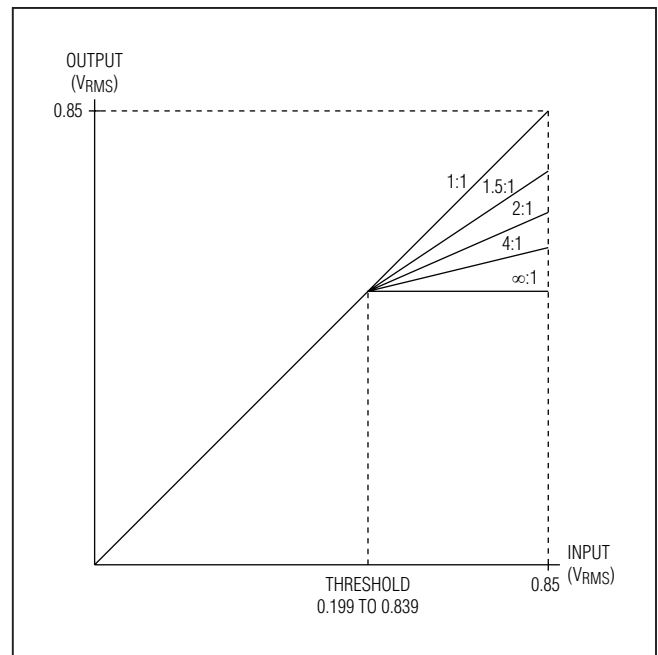

Figure 7. DRC Gain Curve

High-Efficiency, Low-Noise Audio Subsystem

Expander

The IC's speaker and headphone amplifier signal paths include an expander. The expander reduces the noise floor when there is no desired input signal by attenuating peak signals that are below the selected expander threshold (Figure 8). Attenuation is achieved by automatically modifying the speaker or headphone volume to a lower gain setting. Expansion ratio and attack time settings are configured by registers 0x0C for the headphone path and 0x0D for the speaker path. The expansion ratio determines the input:output relationship used when the input signal is below the selected threshold. The expansion attack time determines the time-per-step used when the expander engages. Figure 9 and Figure 10 show the benefits of the expander by comparing the output with the expander disabled against the output with the expander enabled.

The expander acts as a noise gate when the expansion ratio is set to an input:output relationship of infinity:1. In this case, all signals below the selected threshold are muted.

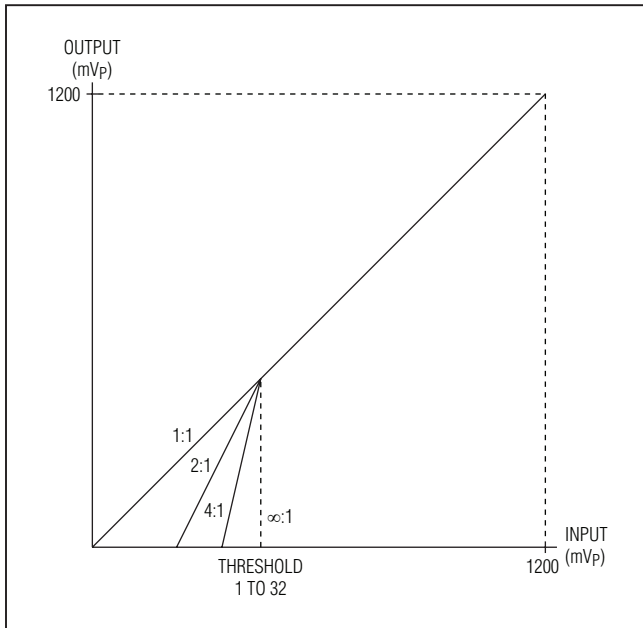

Figure 8. Expander Gain Curve

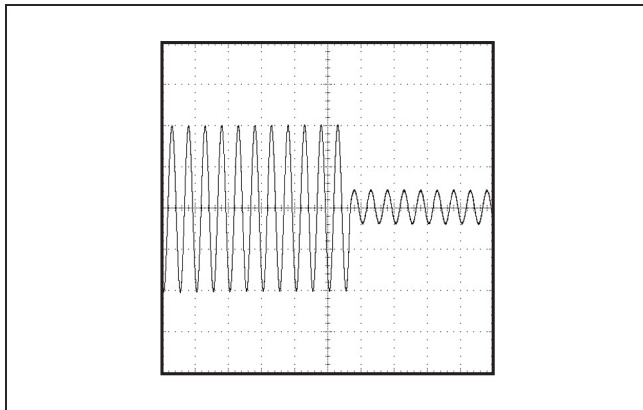

Figure 9. High-Signal to Low-Signal Transition, Expander Disabled

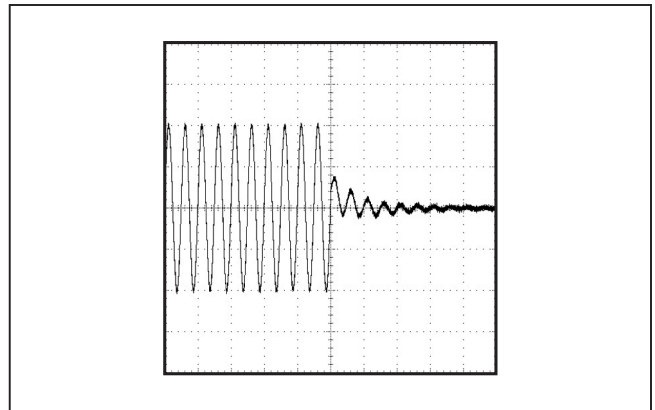

Figure 10. High-Signal to Low-Signal Transition, Expander Enabled

High-Efficiency, Low-Noise Audio Subsystem

Speaker Low-Power Mode

The IC's speaker path expander includes a low-power mode that increases power efficiency when there is no desired input signal. Set the programmable threshold in register 0x0F to determine when low-power mode is activated. When low-power mode is enabled, the Class D switching output is active only if the speaker volume setting selected by the expander is above the selected low-power mode threshold. For example, if the speaker low-power mode threshold is set to -30dB and the input

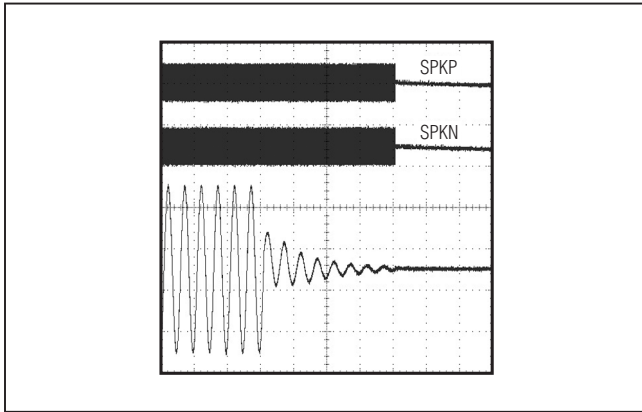

Figure 11. High-Signal to Low-Signal Transition, Speaker Expander with Speaker Low-Power Mode

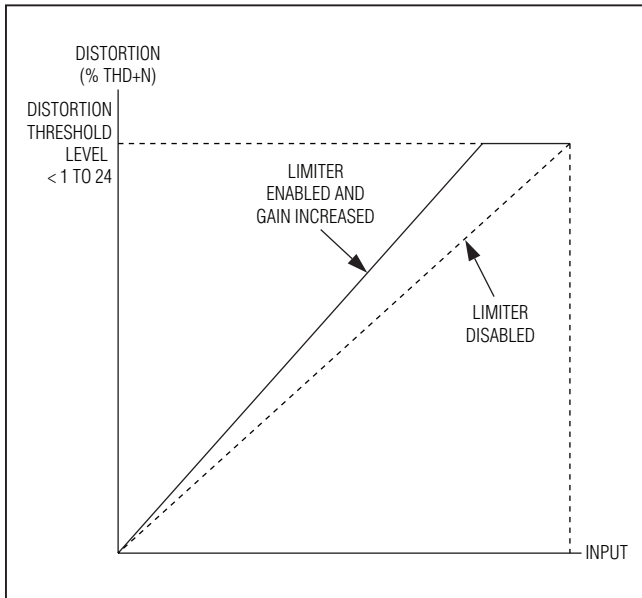

Figure 12. Limiter Gain Curve

signal is such that the speaker expander attenuates the output volume setting to at least -30dB, the Class D amplifier is turned off (Figure 11). Low-power mode is only available when the speaker expander is enabled.

Distortion Limiter

The speaker amplifier integrates a limiter to provide speaker protection and ensures high-quality audio. When enabled, the limiter monitors the audio signal at the output of the Class D speaker amplifier and decreases the gain if the distortion exceeds the predefined threshold. Attenuation is achieved by automatically modifying the speaker volume as appropriate. The limiter automatically tracks the battery voltage to reduce the gain as the battery voltage drops.

Figure 12 shows the typical output vs. input curves with and without the distortion limiter. The dotted line shows the maximum gain for a given distortion limit without the distortion limiter. The solid line shows how, with the distortion limiter enabled, the gain can be increased without exceeding the set distortion limit. When the limiter is enabled, selecting a high gain level results in peak signals being attenuated while low signals are left unchanged. This increases the perceived loudness without the harshness of a clipped waveform.

To operate the distortion limiter, select a distortion threshold and release time constant through the 0x0E register. \overline{ZCD} must be set to 0 in register 0x11 for the distortion limiter to operate properly.

Headphone Amplifier

DirectDrive

Traditional single-supply headphone amplifiers have outputs biased at a nominal DC voltage (typically half the supply). Large coupling capacitors are needed to block this DC bias from the headphone. Without these capacitors, a significant amount of DC current flows to the headphone, resulting in unnecessary power dissipation and possible damage to both headphone and headphone amplifier.

Maxim's patented DirectDrive® architecture uses a charge pump to create an internal negative supply voltage. This allows the headphone outputs of the IC to be biased at GND while operating from a single supply (Figure 13). Without a DC component, there is no need for the large DC-blocking capacitors. Instead of two large (220µF, typ) capacitors, the IC's charge pump requires

DirectDrive is a registered trademark of Maxim Integrated Products, Inc.

High-Efficiency, Low-Noise Audio Subsystem

two small ceramic capacitors, conserving board space, reducing cost, and improving the frequency response of the headphone amplifier. See the Output Power vs. Charge-Pump Capacitance and Load Resistance graph in the [Typical Operating Characteristics](#) section for details of the possible capacitor sizes. There is a low DC voltage on the amplifier outputs due to amplifier offset. However, the offset of the IC is typically $\pm 0.15\text{mV}$, which, when combined with a 32Ω load, results in less than $5\mu\text{A}$ of DC current flow to the headphones.

In addition to the cost and size disadvantages of the DC-blocking capacitors required by conventional headphone amplifiers, these capacitors limit the amplifier's low-frequency response and can distort the audio signal. Previous attempts at eliminating the

output-coupling capacitors involved biasing the headphone return (sleeve) to the DC bias voltage of the headphone amplifiers. This method raises a few issues:

- The sleeve is typically grounded to the chassis. Using the midrail biasing approach, the sleeve must be isolated from system ground, complicating product design.
- During an ESD strike, the amplifier's ESD structures are the only path to system ground. Thus, the amplifier must be able to withstand the full energy from an ESD strike.
- When using the headphone jack as a line out to other equipment, the bias voltage on the sleeve can conflict with the ground potential from other equipment, resulting in possible damage to the amplifiers.

Charge Pump

The IC's dual-mode charge pump generates both the positive and negative power supply for the headphone amplifier. To maximize efficiency, both the charge pump's switching frequency and output voltage change based on signal level.

When the input signal level is less than 10% of V_{DD} , the switching frequency is reduced to a low rate. This minimizes switching-losses in the charge pump. When the input signal exceeds 10% of V_{DD} , the switching frequency increases to support the load current.

For input signals below 25% of V_{DD} , the charge pump generates $\pm(V_{DD}/2)$ to minimize the voltage drop across the amplifier's power stage and thus improves efficiency. Input signals that exceed 25% of V_{DD} cause the charge pump to output $\pm V_{DD}$. The higher output voltage allows for full output power from the headphone amplifier.

To prevent audible glitches when transitioning from the $\pm(V_{DD}/2)$ output mode to the $\pm V_{DD}$ output mode, the charge pump transitions very quickly. This quick change draws significant current from V_{DD} for the duration of the transition. The bypass capacitor on V_{DD} supplies the required current and prevent droop on V_{DD} .

The charge pump's dynamic switching mode can be turned off through the I²C interface. The charge pump can then be forced to output either $\pm(V_{DD}/2)$ or $\pm V_{DD}$ regardless of input signal level.

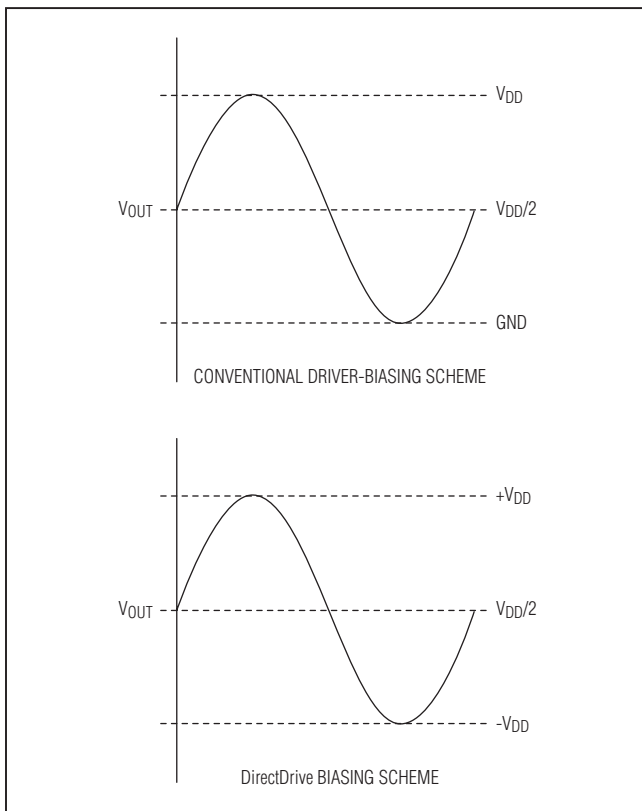

Figure 13. Traditional Amplifier Output vs. MAX97003 DirectDrive Output

High-Efficiency, Low-Noise Audio Subsystem

Class H Operation

A Class H amplifier uses a Class AB output stage with power supplies that are modulated by the output signal. In the case of the IC, two nominal power-supply differentials of 1.8V (+0.9V to -0.9V) and 3.6V (+1.8V to -1.8V) are available from the charge pump. [Figure 14](#) shows the operation of the output voltage dependent power supply.

Ground Sense

The headphone amplifier features output ground sensing that is used to reduce ground loop noise when the headphone output jack is connected to a different ground than the amplifier ground. An example of this is when the headphone jack is used as a lineout and connected to an external power amplifier. In addition, the ground sense reduces noise that can be caused by voltage drops between the amplifier ground and the headphone jack ground pin during normal headphone use. HPSNS must be connected to the ground pin on the headphone jack.

Volume-Change Features

The IC includes several features that enhance performance during volume changes. Zero-crossing detection, volume slewing, and enhanced volume smoothing are used to improve click-and-pop performance during volume changes. Volume readback is used to report the actual volume setting after the DRC, expander, or distortion limiter applies an automatic volume change.

Zero-Crossing Detection

The IC features zero-crossing detection to reduce clicks and pops during volume changes. When zero-crossing detection is enabled, all volume changes are delayed until a zero-crossing has been detected. If no zero-crossing is detected within 100ms, then the zero-crossing detector times out and volume changes are executed.

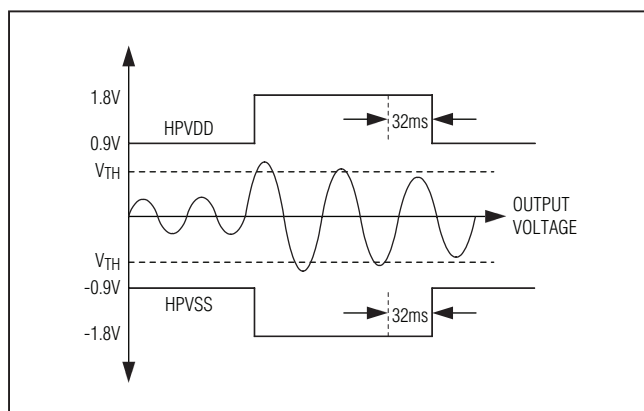

Figure 14. Class H Operation

Disabling zero-crossing detection allows volume changes to occur immediately.

Volume Slewing

The IC offers volume slewing for all volume changes to further reduce clicks and pops. When enabled, the IC ramps through intermediate volume settings when a change to the volume is made. If zero-crossing detection is disabled, slewing occurs at a rate of 0.2ms per step. If zero-crossing detection is enabled, slew time depends on the input signal. If the duration between zero-crossings is less than 0.2ms, the slew time is limited at 0.2ms per volume change. If the duration between zero-crossings is longer than 0.2ms, volume changes occur at each zero-crossing. Volume slewing also provides a soft-start at power-on and soft-stop at power-off.

Enhanced Volume Smoothing

Enhanced volume smoothing can be used when the volume slewing feature is enabled. When enhanced volume smoothing is enabled and a volume change occurs, the IC waits for each step in the ramp to be applied before executing the next step. When zero-crossing detection is enabled, enhanced volume smoothing prevents large steps in the output volume when no zero-crossings are detected.

Volume Readback

The IC features three volume readback registers that report the actual volume settings of the speaker, left headphone, and right headphone volume registers. The DRC, expander, and distortion limiter are capable of automatically adjusting these volume registers according to their respective settings.

I²C Slave Address

The IC's audio subsystem uses a slave address of 0x9A or 1001101 R/W. The address is defined as the 7 most significant bits (MSBs) followed by the read/write bit. Set the read/write bit to 1 to configure the audio subsystem to read mode. Set the read/write bit to 0 to configure the IC to write mode. The address is the first byte of information sent to the IC after the START condition.

Registers Map

19 internal registers program the audio subsystem. [Table 1](#) lists all of the registers, their addresses, and power-on-reset states. Register 0xFF indicates the device revision. Write zeros to all unused bits in the register table when updating the register, unless otherwise noted.

High-Efficiency, Low-Noise Audio Subsystem

Table 1. Register Map

REGISTER	B7	B6	B5	B4	B3	B2	B1	B0	ADDRESS	DEFAULT	R/W	
STATUS												
Left Headphone Volume Readback	0	0	HPLVOLRB						0x00	—	R	
Right Headphone Volume Readback	0	0	HPRVOLRB						0x01	—	R	
Speaker Volume Readback	0	0	SPKVOLRB						0x02	—	R	
Input A Configuration	0	0	0	INADIFF	PGAINA				0x03	0x00	R/W	
Input B Configuration	0	0	0	INBDIFF	PGAINB				0x04	0x00	R/W	
Headphone Mixer	HPLMIX			HPRMIX					0x05	0x00	R/W	
Speaker Mixer	0	0	0	0	SPKMIX				0x06	0x00	R/W	
Left Headphone Volume	HPLM	0	HPLVOL						0x07	0x00	R/W	
Right Headphone Volume	HPRM	0	HPRVOL						0x08	0x00	R/W	
Speaker Volume	SPKM	0	SPKVOL						0x09	0x00	R/W	
Dynamic Range Control	DRCEN			DRCATK		DRCRLS			0x0A	0x00	R/W	
Dynamic Range Control	0	0	0	DRCTH					0x0B	0x00	R/W	
Headphone Expander	EXPEN		EXPHTK			EXPHTH			0x0C	0x00	R/W	
Speaker Expander	EXPSEN		EXPSATK			EXPSTH			0x0D	0x00	R/W	
Distortion Limiter	THDCLP			0	THDRLS					0x0E	0x00	R/W
Speaker Low-Power Mode	SLPEN	0	SLPTH						0x0F	0x00	R/W	
Output Gain	0	0	0	0	HPGAIN		SPKGAIN		0x10	0x00	R/W	
Advanced Configuration	VS2EN	$\overline{\text{SLEW}}$	$\overline{\text{ZCD}}$	0	FFM	0	CPSEL	FIXED	0x11	0x00	R/W	
Power Management	$\overline{\text{SHDN}}$	0	0	0	0	SPKEN	HPLEN	HPREN	0x12	0x00	R/W	
REVISION ID												
Rev ID	REV								0xFF	0x40	R	

High-Efficiency, Low-Noise Audio Subsystem

Volume Readback

The Volume Readback registers report the actual volume setting of each output volume control when the DRC, expander, or distortion limiter is active.

Table 2. Volume Readback Registers

REGISTER	BIT	NAME	DESCRIPTION							
0x00/0x01/ 0x02	5	HPLVOLRB/ HPRVOLRB/ SPKVOLRB	Output Volume							
			VALUE	GAIN (dB)	VALUE	GAIN (dB)	VALUE	GAIN (dB)	VALUE	GAIN (dB)
			0x00	-63	0x10	-47	0x20	-31	0x30	-15
	4		0x01	-62	0x11	-46	0x21	-30	0x31	-14
			0x02	-61	0x12	-45	0x22	-29	0x32	-13
			0x03	-60	0x13	-44	0x23	-28	0x33	-12
			0x04	-59	0x14	-43	0x24	-27	0x34	-11
	3		0x05	-58	0x15	-42	0x25	-26	0x35	-10
			0x06	-57	0x16	-41	0x26	-25	0x36	-9
			0x07	-56	0x17	-40	0x27	-24	0x37	-8
	2		0x08	-55	0x18	-39	0x28	-23	0x38	-7
			0x09	-54	0x19	-38	0x29	-22	0x39	-6
			0x0A	-53	0x1A	-37	0x2A	-21	0x3A	-5
	1		0x0B	-52	0x1B	-36	0x2B	-20	0x3B	-4
			0x0C	-51	0x1C	-35	0x2C	-19	0x3C	-3
			0x0D	-50	0x1D	-34	0x2D	-18	0x3D	-2
	0		0x0E	-49	0x1E	-33	0x2E	-17	0x3E	-1
0x0F		-48	0x1F	-32	0x2F	-16	0x3F	0		

High-Efficiency, Low-Noise Audio Subsystem

Input Configuration

The input configuration registers allow the selection of single-ended or differential modes as well as preamp gain settings for INA and INB.

Table 3. Input Configuration Registers

REGISTER	BIT	NAME	DESCRIPTION			
0x03/0x04	4	INADIFF/ INBDIFF	Input A/B Differential Mode. Configures the input as either a mono differential signal (IN_ = IN_2 - IN_1) or as a stereo signal (IN_1 = left, IN_2 = right). 0 = Stereo single-ended 1 = Differential			
	3	PGAINA/ PGAINB	Input A/B Preamp Gain. Set the input gain to maximize output signal level for a given input signal range to improve the SNR of the system.			
			VALUE	LEVEL (dB)	VALUE	LEVEL (dB)
	2		0x0	-3	0x6	+6
			0x1	-1.5	0x7	+7.5
	1		0x2	-0	0x8	+9
			0x3	+1.5	0x9	+10.5
	0		0x4	+3	0xA-0xF	+12
	0x5	+4.5	—	—		

High-Efficiency, Low-Noise Audio Subsystem

Mixers

The IC features independent mixers for the left headphone, right headphone, and speaker paths. Each output can select any combination of any inputs. This allows for mixing two audio signals together and routing independent signals to the headphone and speaker amplifiers. If one of the inputs is not selected by either mixer, it is automatically powered down to reduce current consumption.

Table 4. Mixer Registers

REGISTER	BIT	NAME	DESCRIPTION	
0x05	7	HPLMIX	Left Headphone Mixer. Selects which of the four inputs is routed to the left headphone output.	
	6		0000	No input
	5		xxx1	INA1 (Disabled when INADIFF = 1)
	4		xx1x	INA2 (Select when INADIFF = 1)
			x1xx	INB1 (Disabled when INBDIFF = 1)
			1xxx	INB2 (Select when INBDIFF = 1)
	3	HPRMIX	Right Headphone Mixer. Selects which of the four inputs is routed to the right headphone output.	
	2		0000	No input
1	xxx1		INA1 (Disabled when INADIFF = 1)	
0	xx1x		INA2 (Select when INADIFF = 1)	
		x1xx	INB1 (Disabled when INBDIFF = 1)	
		1xxx	INB2 (Select when INBDIFF = 1)	
0x06	3	SPKMIX	Speaker Mixer. Selects which of the four inputs is routed to the speaker output.	
	2		0000	No input
	1		xxx1	INA1 (Disabled when INADIFF = 1)
	0		xx1x	INA2 (Select when INADIFF = 1)
		x1xx	INB1 (Disabled when INBDIFF = 1)	
		1xxx	INB2 (Select when INBDIFF = 1)	

High-Efficiency, Low-Noise Audio Subsystem

Volume Control

The speaker, left headphone, and right headphone have independent volume control registers that allow a gain to be selected from -63dB to 0dB.

Table 5. Headphone Volume Control Registers

REGISTER	BIT	NAME	DESCRIPTION									
0x07/0x08/ 0x09	7	HPLM/ HPRM/ SPKM	Output Mute 0 = Unmuted 1 = Muted									
	5	HPLVOL/ HPRVOL/ SPKVOL	Output Volume									
			VALUE	GAIN (dB)	VALUE	GAIN (dB)	VALUE	GAIN (dB)	VALUE	GAIN (dB)		
	4		0x00	-63	0x10	-47	0x20	-31	0x30	-15		
			0x01	-62	0x11	-46	0x21	-30	0x31	-14		
			0x02	-61	0x12	-45	0x22	-29	0x32	-13		
			0x03	-60	0x13	-44	0x23	-28	0x33	-12		
	3		0x04	-59	0x14	-43	0x24	-27	0x34	-11		
			0x05	-58	0x15	-42	0x25	-26	0x35	-10		
			0x06	-57	0x16	-41	0x26	-25	0x36	-9		
			0x07	-56	0x17	-40	0x27	-24	0x37	-8		
	2		0x08	-55	0x18	-39	0x28	-23	0x38	-7		
			0x09	-54	0x19	-38	0x29	-22	0x39	-6		
			0x0A	-53	0x1A	-37	0x2A	-21	0x3A	-5		
			0x0B	-52	0x1B	-36	0x2B	-20	0x3B	-4		
	1		0x0C	-51	0x1C	-35	0x2C	-19	0x3C	-3		
			0x0D	-50	0x1D	-34	0x2D	-18	0x3D	-2		
			0x0E	-49	0x1E	-33	0x2E	-17	0x3E	-1		
			0x0F	-48	0x1F	-32	0x2F	-16	0x3F	0		

High-Efficiency, Low-Noise Audio Subsystem

Dynamic Range Control

The DRC attenuates high-level signals without affecting low-level signals. Attenuation is achieved by automatically modifying the speaker volume as appropriate. When the DRC is enabled, the overall volume can be increased without clipping the high-level signals. To operate the DRC, select a compression threshold, compression ratio, attack time constant, and release time.

Table 6. Dynamic Range Control Registers

REGISTER	BIT	NAME	DESCRIPTION				
0x0A	7	DRCEN	DRC Enable and Compression Ratio 000 = 1:1 (disabled) 001 = 1.34:1 010 = 2:1 011 = 4:1 100 – 111 = ∞:1				
	6						
	5						
	4	DRCATK	DRC Attack Time Constant. Defines the time constant used during attack. 00 = 500μs 01 = 1ms 10 = 10ms 11 = 50ms				
	3						
	2	DRCRLS	DRC Release Time. Defines the release rate per step. 000 = 800ms 001 = 400ms 010 = 150ms 011 = 75ms 100 = 50ms 101–111 = 25ms				
	1						
0							
0x0B	4	DRCTH	Compression Threshold Level. Specifies the minimum input signal level for which compression is applied.				
	3			VALUE	LEVEL (V_{RMS})	VALUE	LEVEL (V_{RMS})
				0x00	Reserved	0x10	0.354
	2			0x01	0.839	0x11	0.334
				0x02	0.792	0x12	0.315
				0x03	0.748	0x13	0.298
				0x04	0.706	0x14	0.281
				0x05	0.667	0x15	0.265
				0x06	0.629	0x16	0.251
				0x07	0.594	0x17	0.237
				0x08	0.561	0x18	0.223
	1			0x09	0.529	0x19	0.211
				0x0A	0.500	0x1A–0x1F	0.199
	0			0x0B	0.472		
				0x0C	0.445		
				0x0D	0.421		
0x0E		0.397					
	0x0F	0.375					

High-Efficiency, Low-Noise Audio Subsystem

Expander (Noise Gate)

The expander/noise gate eliminates noise when no desired signal is present by attenuating peak signals that are below the selected threshold. Attenuation is achieved by automatically modifying the headphone or speaker volume as appropriate. To operate the headphone or speaker expander, select an expansion threshold, expansion ratio, and attack time in the appropriate headphone or speaker expander registers.

Table 7. Expander Registers

REGISTER	BIT	NAME	DESCRIPTION	
0x0C/0x0D	7	EXPHEN/ EXPSEN	Headphone/Speaker Expansion Ratio 00 = 1:1 (disabled) 01 = 2:1 10 = 4:1 11 = ∞:1 (noise gate)	
	6			
	5	EXPHATK/ EXPSATK	Headphone/Speaker Expander Attack Time. Decreases volume after the signal drops below the selected expander threshold.	
			VALUE	ATTACK TIME (ms/step)
	4		000	500
			001	350
			010	250
			011	100
	3		100	50
			101	25
			110–111	15
	2	EXPHTH/ EXPSTH	Headphone/Speaker Noise Gate Threshold. The expander attenuates or mutes the output below this threshold. Thresholds are based on the PGA input signal level.	
	VALUE		THRESHOLD (mV_p)	
	0x0		Reserved	
1	0x1		32	
	0x2		20	
	0x3		10	
	0x4		8	
	0x5		4	
0		0x6	2	
		0x7	1	

High-Efficiency, Low-Noise Audio Subsystem

Distortion Limiter

The distortion limiter monitors the audio signal at the output of the Class D speaker amplifier and decreases the gain if the distortion exceeds the selected threshold. Attenuation is achieved by automatically modifying the speaker volume as appropriate. To operate the distortion limiter, select a distortion limit (% THD+N) and a release time constant.

Table 8. Distortion Limiter Register

REGISTER	BIT	NAME	DESCRIPTION			
0x0E	7	THDCLP	Distortion Limit. Measured in % THD+N. \overline{ZCD} must be set to 0 for the distortion limiter to function.			
	6		VALUE	DISTORTION LIMIT (%)	VALUE	DISTORTION LIMIT (%)
			0x0	Limiter disabled	0x8	12
			0x1	< 1	0x9	14
			0x2	1	0xA	16
			0x3	2	0xB	18
			0x4	4	0xC	20
			0x5	6	0xD	21
		0x6	8	0xE	22	
	0x7	10	0xF	24		
	2	THDRLS	Limiter Release Time Constant. Time constant used while increasing the gain after distortion is no longer detected at the output.			
1	000 = 6.2s					
	001 = 3.1s					
0	010 = 1.6s					
	011 = 815ms					
	100 = 419ms					
	101 = 223ms					
110 = 116ms						
111 = 76ms						

High-Efficiency, Low-Noise Audio Subsystem

Speaker Low-Power Mode

The speaker expander includes a low-power mode that increases power efficiency when a desired audio signal is not present. When this feature is enabled, the Class D switching output is active only if the speaker volume setting selected by the expander is above the selected low-power mode threshold. Low-power mode is only available when the speaker expander is enabled.

Table 9. Speaker Low-Power Mode Register

REGISTER	BIT	NAME	DESCRIPTION							
0x0F	7	SLPEN	Speaker Low-Power Mode. Only functions if EXPSEN ≠ 0. 0 = Class D output is active continuously. 1 = Class D output is active if the speaker volume setting selected by the expander is above SLPTH.							
	5	SLPTH	Speaker Low-Power Mode Volume Threshold. Threshold used to determine if speaker amplifier should be enabled or disabled. If the volume selected by the expander is less than this threshold, the speaker amplifier is disabled.							
	4		VALUE	GAIN (dB)	VALUE	GAIN (dB)	VALUE	GAIN (dB)	VALUE	GAIN (dB)
	3		0x00	-63	0x10	-47	0x20	-31	0x30	-15
			0x01	-62	0x11	-46	0x21	-30	0x31	-14
			0x02	-61	0x12	-45	0x22	-29	0x32	-13
	2		0x03	-60	0x13	-44	0x23	-28	0x33	-12
			0x04	-59	0x14	-43	0x24	-27	0x34	-11
			0x05	-58	0x15	-42	0x25	-26	0x35	-10
			0x06	-57	0x16	-41	0x26	-25	0x36	-9
			0x07	-56	0x17	-40	0x27	-24	0x37	-8
	1		0x08	-55	0x18	-39	0x28	-23	0x38	-7
			0x09	-54	0x19	-38	0x29	-22	0x39	-6
			0x0A	-53	0x1A	-37	0x2A	-21	0x3A	-5
			0x0B	-52	0x1B	-36	0x2B	-20	0x3B	-4
			0x0C	-51	0x1C	-35	0x2C	-19	0x3C	-3
	0		0x0D	-50	0x1D	-34	0x2D	-18	0x3D	-2
			0x0E	-49	0x1E	-33	0x2E	-17	0x3E	-1
			0x0F	-48	0x1F	-32	0x2F	-16	0x3F	0

High-Efficiency, Low-Noise Audio Subsystem

Output Gain

The output stage of the headphone and speaker amplifiers can be configured to provide additional gain. The headphone amplifier allows a range of 0dB to +6dB. The speaker amplifier allows range of +12dB to +24dB.

Table 10. Output Gain Register

REGISTER	BIT	NAME	DESCRIPTION
0x10	3	HPGAIN	Headphone Output Gain 00 = 0dB 01 = +2dB 10 = +4dB 11 = +6dB
	2		
	1	SPKGAIN	Speaker Output Gain 00 = +12dB 01 = +16dB 10 = +20dB 11 = +24dB
	0		

High-Efficiency, Low-Noise Audio Subsystem

Advanced Configuration

The IC includes several advanced configurations related to automatic volume changes initiated by the DRC, expander, and distortion limiter. In addition, settings for the Class D speaker modulation scheme and headphone charge pump are configured in register 0x11.

Table 11. Advanced Configuration Register

REGISTER	BIT	NAME	DESCRIPTION
0x11	7	VS2EN	Enhanced Volume Smoothing. During volume slewing, the controller waits for each step in the ramp to be applied before executing the next step. When zero-crossing detection is enabled, this prevents large steps in the output volume when no zero-crossings are detected. 0 = Disabled 1 = Enabled
	6	$\overline{\text{SLEW}}$	Volume Slewing. Determines whether volume slewing is used on all volume control changes to reduce clicks and pops. When enabled, volume changes cause the IC to ramp through intermediate volume settings whenever a change to the volume is made. If $\overline{\text{ZCD}} = 1$, slewing occurs at a rate of 0.2ms per step. If $\overline{\text{ZCD}} = 0$, slew time depends on the input signal frequency. This bit also activates soft-start at power-on and soft-stop at power-off. 0 = Enabled 1 = Disabled
	5	$\overline{\text{ZCD}}$	Zero-Crossing Detection. Determines whether zero-crossing detection is used on all volume control changes to reduce clicks and pops. Disabling zero-crossing detection allows volume changes to occur immediately. Zero-crossing detection times out at 100ms. 0 = Enabled 1 = Disabled
	3	FFM	Fixed Class D Frequency Enable 0 = Spread-spectrum modulation 1 = Fixed-frequency modulation
	1	CPSEL	Charge-Pump Output Select. Works with FIXED to set $\pm V_{DD}$ or $\pm V_{DD}/2$ outputs on CPVDD and CPVSS. Ignored when FIXED = 0. 0 = $\pm V_{DD}$ on CPVDD/CPVSS 1 = $\pm V_{DD}/2$ on CPVDD/CPVSS
	0	FIXED	Class H Mode. When enabled, this bit forces the charge pump to generate static power rails for CPVDD and CPVSS, instead of dynamically adjusting them based on output signal level. 0 = Class H mode 1 = Fixed supply mode

High-Efficiency, Low-Noise Audio Subsystem

Power Management

The power management register allows the speaker, left headphone, and right headphone signal paths to be enabled. It also enables the IC device.

Table 12. Power Management Register

REGISTER	BIT	NAME	DESCRIPTION
0x12	7	$\overline{\text{SHDN}}$	Software Shutdown 0 = Device disabled 1 = Device enabled
	2	SPKEN	Speaker Amplifier Enable 0 = Disabled 1 = Enabled
	1	HPLEN	Left Headphone Amplifier Enable 0 = Disabled 1 = Enabled
	0	HPREN	Right Headphone Amplifier Enable 0 = Disabled 1 = Enabled

I²C Serial Interface

The IC features an I²C/SMBus-compatible, two-wire serial interface consisting of a serial-data line (SDA) and a serial-clock line (SCL). SDA and SCL facilitate communication between the IC and the master at clock rates up to 400kHz. Figure 1 shows the two-wire interface timing diagram. The master generates SCL and initiates data transfer on the bus. The master device writes data to the IC by transmitting the proper slave address followed by the register address and then the data word. Each transmit

sequence is framed by a START (S) or REPEATED START (Sr) condition and a STOP (P) condition. Each word transmitted to the IC is 8 bits long and is followed by an acknowledge clock pulse. A master reading data from the IC transmits the proper slave address followed by a series of nine SCL pulses. The IC transmits data on SDA in sync with the master-generated SCL pulses. The master acknowledges receipt of each byte of data. Each read sequence is framed by a START (S) or REPEATED START (Sr) condition, a not acknowledge, and a STOP

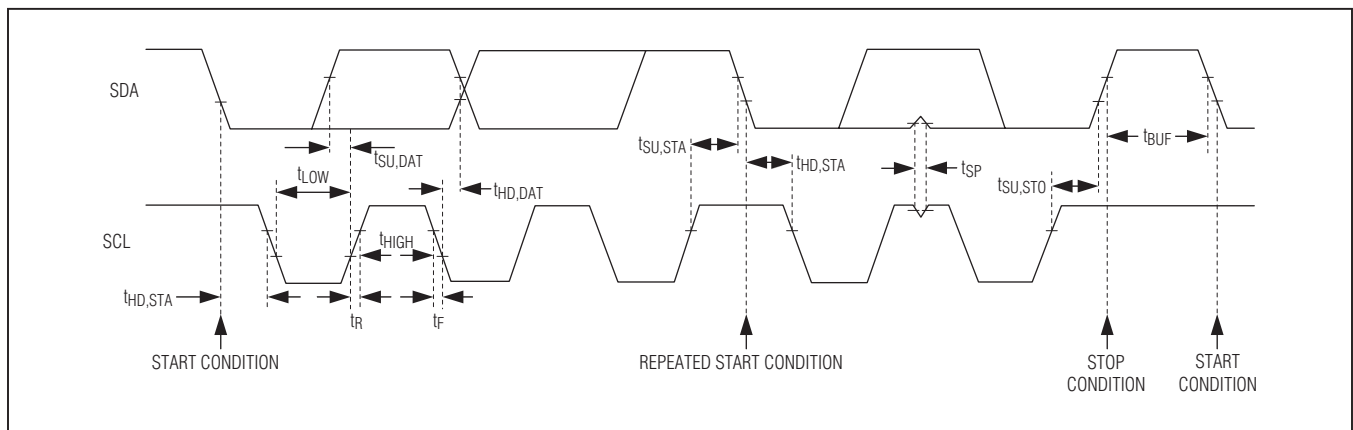

Figure 15. I²C Serial Interface Timing Diagram

High-Efficiency, Low-Noise Audio Subsystem

(P) condition. SDA operates as both an input and an open-drain output. A pullup resistor, typically greater than 500Ω, is required on SDA. SCL operates only as an input. A pullup resistor, typically greater than 500Ω, is required on SCL if there are multiple masters on the bus, or if the single master has an open-drain SCL output. Series resistors in line with SDA and SCL are optional. Series resistors protect the digital inputs of the IC from high voltage spikes on the bus lines, and minimize crosstalk and undershoot of the bus signals.

Bit Transfer

One data bit is transferred during each SCL cycle. The data on SDA must remain stable during the high period of the SCL pulse. Changes in SDA while SCL is high are control signals. See the [START and STOP Conditions](#) section.

START and STOP Conditions

SDA and SCL idle high when the bus is not in use. A master initiates communication by issuing a START condition. A START condition is a high-to-low transition on SDA with SCL high. A STOP condition is a low-to-high transition on SDA while SCL is high (Figure 16). A START condition from the master signals the beginning of a transmission to the IC. The master terminates transmission, and frees

the bus, by issuing a STOP condition. The bus remains active if a REPEATED START condition is generated instead of a STOP condition.

Early STOP Conditions

The IC recognizes a STOP condition at any point during data transmission except if the STOP condition occurs in the same high pulse as a START condition. For proper operation, do not send a STOP condition during the same SCL high pulse as the START condition.

Slave Address

The slave address is defined as the seven most significant bits (MSBs) followed by the read/write bit. For the IC, the seven most significant bits are 1001101. Setting the read/write bit to 1 (slave address = 0x9B) configures the IC for read mode. Setting the read/write bit to 0 (slave address = 0x9A) configures the IC for write mode. The address is the first byte of information sent to the IC after the START condition.

Acknowledge

The acknowledge bit (ACK) is a clocked ninth bit that the IC uses to handshake receipt each byte of data when in write mode (Figure 17). The IC pulls down SDA during the entire master-generated ninth clock pulse if the previous byte is successfully received. Monitoring ACK allows for detection of unsuccessful data transfers. An unsuccessful data transfer occurs if a receiving device is busy or if a system fault has occurred. In the event of an unsuccessful data transfer, the bus master retries communication. The master pulls down SDA during the ninth clock cycle to acknowledge receipt of data when the IC is in read mode. An acknowledge is sent by the master after each read byte to allow data transfer to continue. A not-acknowledge is sent when the master reads the final byte of data from the IC, followed by a STOP condition.

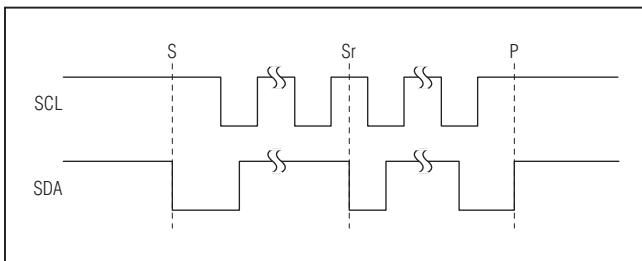

Figure 16. START, STOP, and REPEATED START Conditions

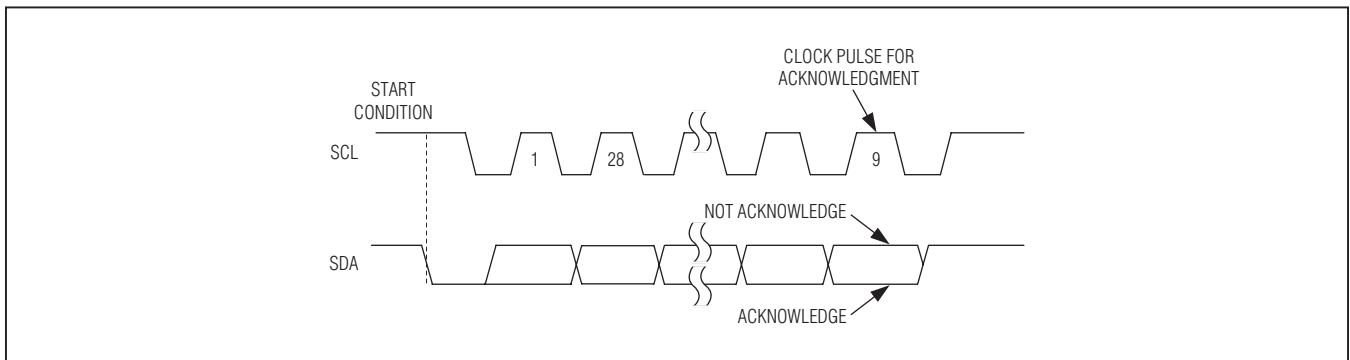

Figure 17. Acknowledge

High-Efficiency, Low-Noise Audio Subsystem

Write Data Format

A write to the IC includes transmission of a START condition, the slave address with the R/W bit set to 0, one byte of data to configure the internal register address pointer, one or more bytes of data, and a STOP condition. [Figure 18](#) illustrates the proper frame format for writing one byte of data to the IC. [Figure 19](#) illustrates the frame format for writing n-bytes of data to the IC.

The slave address with the R/W bit set to 0 indicates that the master intends to write data to the IC. The IC acknowledges receipt of the address byte during the master-generated ninth SCL pulse. The IC acknowledges receipt of the address byte during the master-generated ninth SCL pulse.

The second byte transmitted from the master configures the IC's internal register address pointer. The pointer tells

the IC where to write the next byte of data. An acknowledge pulse is sent by the IC upon receipt of the address pointer data.

The third byte sent to the IC contains the data that are written to the chosen register. An acknowledge pulse from the IC signals receipt of the data byte. The address pointer autoincrements to the next register address after each received data byte. This autoincrement feature allows a master to write to sequential registers within one continuous frame. The master signals the end of transmission by issuing a STOP condition. Register addresses greater than 0x12 are reserved. Do not write to these addresses.

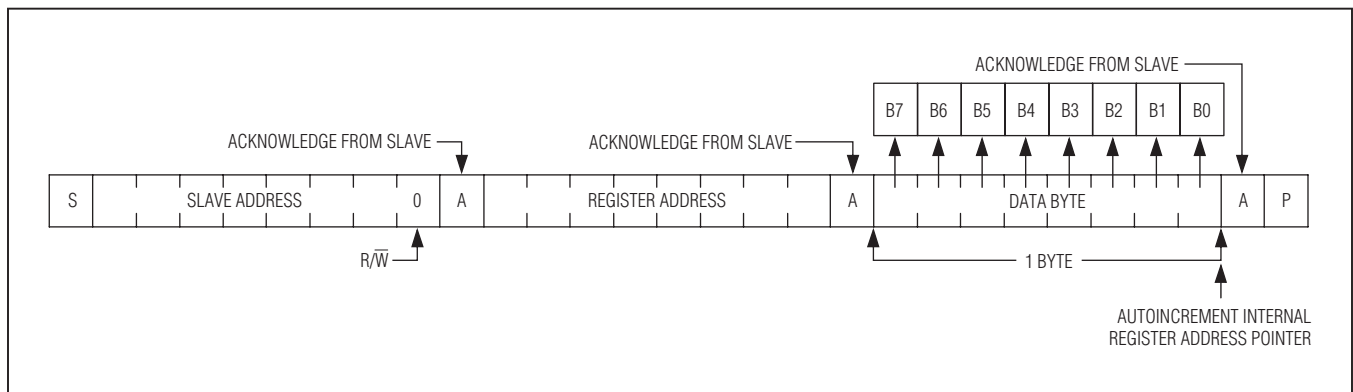

Figure 18. Writing 1 Byte of Data to the IC

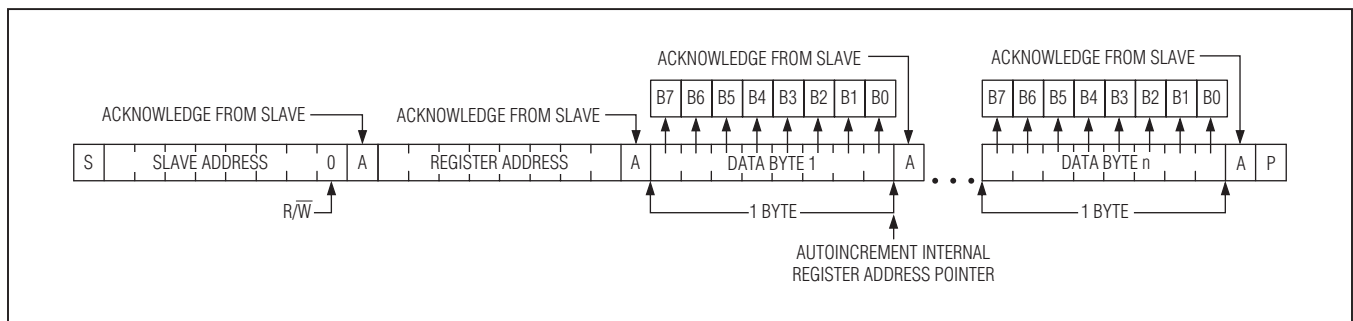

Figure 19. Writing n-Bytes of Data to the IC

High-Efficiency, Low-Noise Audio Subsystem

Read Data Format

Send the slave address with the R/\bar{W} bit set to 1 to initiate a read operation. The IC acknowledges receipt of its slave address by pulling SDA low during the ninth SCL clock pulse. A START command followed by a read command resets the address pointer to register 0x00.

The first byte transmitted from the IC is the contents of register 0x00. Transmitted data is valid on the rising edge of SCL. The address pointer autoincrements after each read data byte. This autoincrement feature allows all registers to be read sequentially within one continuous frame. A STOP condition can be issued after any number of read data bytes. If a STOP condition is issued followed by another read operation, the first data byte to be read are from register 0x00.

The address pointer can be preset to a specific register before a read command is issued. The master presets the address pointer by first sending the IC's slave address with the R/\bar{W} bit set to 0 followed by the register address. A REPEATED START condition is then sent followed by the slave address with the R/\bar{W} bit set to 1. The IC then transmits the contents of the specified register. The address pointer autoincrements after transmitting the first byte.

The master acknowledges receipt of each read byte during the acknowledge clock pulse. The master must acknowledge all correctly received bytes except the last byte. The final byte must be followed by a not acknowledge from the master and then a STOP condition. [Figure 20](#) illustrates the frame format for reading one byte from the IC. [Figure 21](#) illustrates the frame format for reading multiple bytes from the IC.

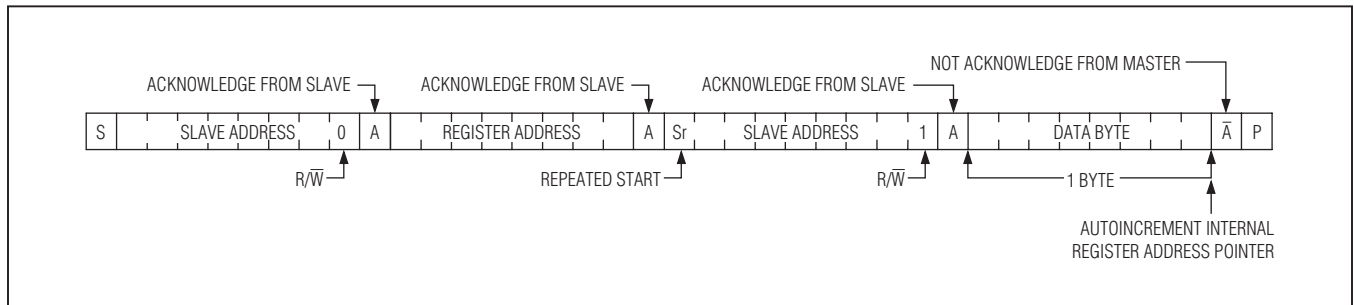

Figure 20. Reading One Byte of Data from the IC

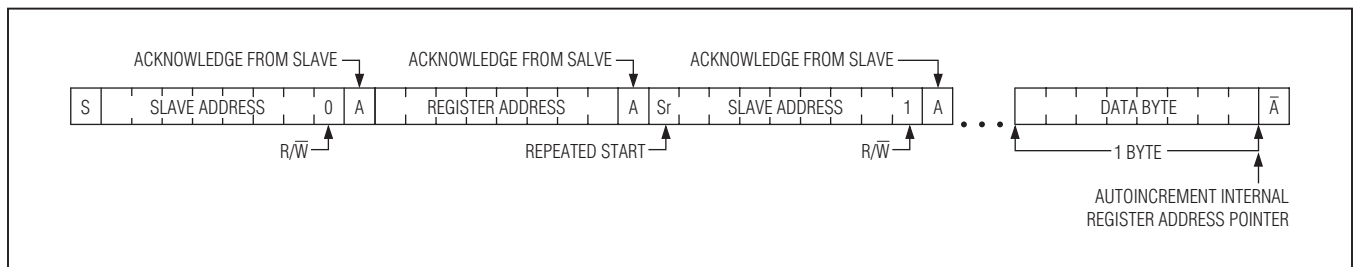

Figure 21. Reading n-Bytes of Data from the IC

High-Efficiency, Low-Noise Audio Subsystem

Applications Information

Filterless Class D Operation

Traditional Class D amplifiers require an output filter to recover the audio signal from the amplifier's output. The filters add cost, increase the solution size of the amplifier, and can decrease efficiency and THD+N performance. The traditional PWM scheme uses large differential output swings ($2 \times V_{PVDD}$ peak-to-peak) and causes large ripple currents. Any parasitic resistance in the filter components results in a loss of power, lowering the efficiency.

The IC does not require an output filter. The device relies on the inherent inductance of the speaker coil and the natural filtering of both the speaker and the human ear to recover the audio component of the square-wave output. Eliminating the output filter results in a smaller, less costly, more efficient solution.

Because the frequency of the IC output is well beyond the bandwidth of most speakers, voice coil movement due to the square-wave frequency is very small. Although this movement is small, a speaker not designed to handle the additional power can be damaged. For optimum results, use a speaker with a series inductance $> 10\mu\text{H}$. Typical 8Ω speakers exhibit series inductances in the $20\mu\text{H}$ to $100\mu\text{H}$ range.

RF Susceptibility

GSM radios transmit using time-division multiple access (TDMA) with 217Hz intervals. The result is an RF signal with strong amplitude modulation at 217Hz and its harmonics that is easily demodulated by audio amplifiers. The IC is designed specifically to reject RF signals. PCB layout, however, has a large impact on the susceptibility of the end product.

In RF applications, improvements to both layout and component selection decreases the IC's susceptibility to RF noise and prevent RF signals from being demodulated into audible noise. Trace lengths should be kept below $1/4$ of the wavelength of the RF frequency of interest. Minimizing the trace lengths prevents them from functioning as antennas and coupling RF signals into the IC. The wavelength (λ) in meters is given by: $\lambda = c/f$ where $c = 3 \times 10^8$ m/s, and f = the RF frequency of interest.

Route audio signals on middle layers of the PCB to allow ground planes above and below to shield them from RF interference. Ideally, the top and bottom layers of the PCB should primarily be ground planes to create effective shielding.

Additional RF immunity can also be obtained by relying on the self-resonant frequency of capacitors as it exhibits the frequency response similar to a notch filter. Depending on the manufacturer, 10pF to 20pF capacitors typically exhibit self resonance at RF frequencies. These capacitors when placed at the input pins can effectively shunt the RF noise at the inputs of the IC. For these capacitors to be effective, they must have a low-impedance, low-inductance path to the ground plane. Avoid using microvias to connect to the ground plane whenever possible as these vias do not conduct well at RF frequencies.

Startup/Shutdown Sequencing

To ensure proper device initialization and minimal click-and-pop, program the IC's control registers in the correct order. [Table 13](#) lists the correct startup sequence for the device. To shutdown the IC, simply set $\overline{\text{SHDN}} = 0$.

Table 13. Startup Sequence

SEQUENCE	DESCRIPTION	REGISTERS
1	Ensure $\overline{\text{SHDN}} = 0$	0x12
2	Configure inputs	0x03, 0x04
3	Configure mixers	0x05, 0x06
4	Configure volume	0x07, 0x08, 0x09
5	Configure output gain	0x10
6	Enable amplifiers	0x12
7	Configure expander and DRC	0x0A–0x0F
10	Set $\overline{\text{SHDN}} = 1$	0x12

High-Efficiency, Low-Noise Audio Subsystem

Component Selection

Optional Ferrite Bead Filter

For applications in which speaker leads exceed 20mm, additional EMI suppression can be achieved by using a filter constructed from a ferrite bead and a capacitor to ground (Figure 22). Use a ferrite bead with low DC resistance, high frequency (> 600MHz) impedance between 100Ω and 600Ω, and rated for at least 1A. The capacitor value varies based on the ferrite bead chosen and the actual speaker lead length. Select a capacitor less than 1nF based on EMI performance.

Input Capacitor

An input capacitor, C_{IN} , in conjunction with the input impedance of the IC line inputs forms a highpass filter that removes the DC bias from an incoming analog signal. The AC-coupling capacitor allows the amplifier to automatically bias the signal to an optimum DC level. Assuming zero source impedance, the -3dB point of the highpass filter is given by:

$$f_{-3dB} = \frac{1}{2\pi R_{IN} C_{IN}}$$

R_{IN} is defined in the [Electrical Characteristics](#) table under the Input Resistance section. Choose C_{IN} so that f_{-3dB} is well below the lowest frequency of interest. For best audio quality, use capacitors whose dielectrics have low-voltage coefficients, such as tantalum or aluminum electrolytic. Capacitors with high-voltage coefficients, such as ceramics, can result in increased distortion at low frequencies.

Charge-Pump Capacitor Selection

Use capacitors with an ESR less than 100mΩ for optimum performance. Low-ESR ceramic capacitors minimize the output resistance of the charge pump. Most surface-mount ceramic capacitors satisfy the ESR requirement. For best performance over the extended temperature range, select capacitors with an X7R dielectric.

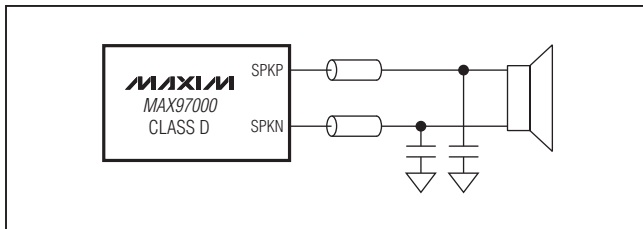

Figure 22. Optional Class D Ferrite Bead Filter

Charge-Pump Flying Capacitor

The value of the flying capacitor (connected between C1N and C1P) affects the output resistance of the charge pump. A value that is too small degrades the device's ability to provide sufficient current drive, which leads to a loss of output voltage. Increasing the value of the flying capacitor reduces the charge-pump output resistance to an extent. Above 1μF, the on-resistance of the internal switches and the ESR of external charge-pump capacitors dominate.

Charge-Pump Holding Capacitor

The holding capacitor (bypassing CPVSS) value and ESR directly affect the ripple at CPVSS. Increasing the capacitor's value reduces output ripple. Likewise, decreasing the ESR reduces both ripple and output resistance. Lower capacitance values can be used in systems with low maximum output power levels. See the Output Power vs. Load Resistance graph in the [Typical Operating Characteristics](#) section for more information.

Supply Bypassing, Layout, and Grounding

Proper layout and grounding are essential for optimum performance. Use a large continuous ground plane on a dedicated layer of the PCB to minimize loop areas. Connect GND and PGND directly to the ground plane using the shortest trace length possible. Proper grounding improves audio performance, minimizes crosstalk between channels, and prevents digital noise from coupling into the analog signals.

Place the capacitor between C1P and C1N as close as possible to the IC to minimize trace length from C1P to C1N. Inductance and resistance added to C1P and C1N reduce the output power of the headphone amplifier. Bypass CPVDD and CPVSS with capacitors located close to the pins with a short trace length to PGND. Close decoupling of CPVDD and CPVSS minimizes supply ripple and maximizes output power from the headphone amplifier.

Bypass PVDD to PGND with as little trace length as possible. Connect SPKP and SPKN to the speaker using the shortest and widest traces possible. Reducing trace length minimizes radiated EMI. Route SPKP/SPKN as a differential pair on the PCB to minimize the loop area and thereby the inductance of the circuit. If filter components are used on the speaker outputs, be sure to locate them as close as possible to the IC to ensure maximum effectiveness. Minimize the trace length from any ground tied passive components to PGND to further minimize radiated EMI.

High-Efficiency, Low-Noise Audio Subsystem

An evaluation kit (EV kit) is available to provide an example layout for the IC. The EV kit allows quick setup of the IC and includes easy-to-use software allowing all internal registers to be controlled.

WLP Applications Information

For the latest application details on WLP construction, dimensions, tape carrier information, PCB techniques,

bump-pad layout, and recommended reflow temperature profile, as well as the latest information on reliability testing results, refer to the Application Note 1891: *Wafer-Level Packaging (WLP) and its Applications* on Maxim's website. [Figure 23](#) shows the dimensions of the WLP balls used on the IC.

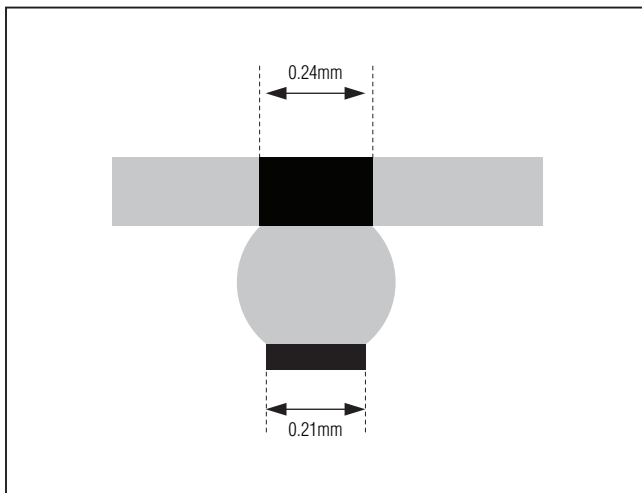

Figure 23. WLP Ball Dimensions

Ordering Information

PART	TEMP RANGE	PIN-PACKAGE
MAX97003EWP+	-40°C to +85°C	20 WLP

+Denotes a lead(Pb)-free/RoHS-compliant package.

High-Efficiency, Low-Noise Audio Subsystem

Package Information

For the latest package outline information and land patterns (footprints), go to www.maxim-ic.com/packages. Note that a "+", "#", or "-" in the package code indicates RoHS status only. Package drawings may show a different suffix character, but the drawing pertains to the package regardless of RoHS status.

PACKAGE TYPE	PACKAGE CODE	OUTLINE NO.	LAND PATTERN NO.
20 WLP	W201A2+1	21-0544	Refer to Application Note 1891

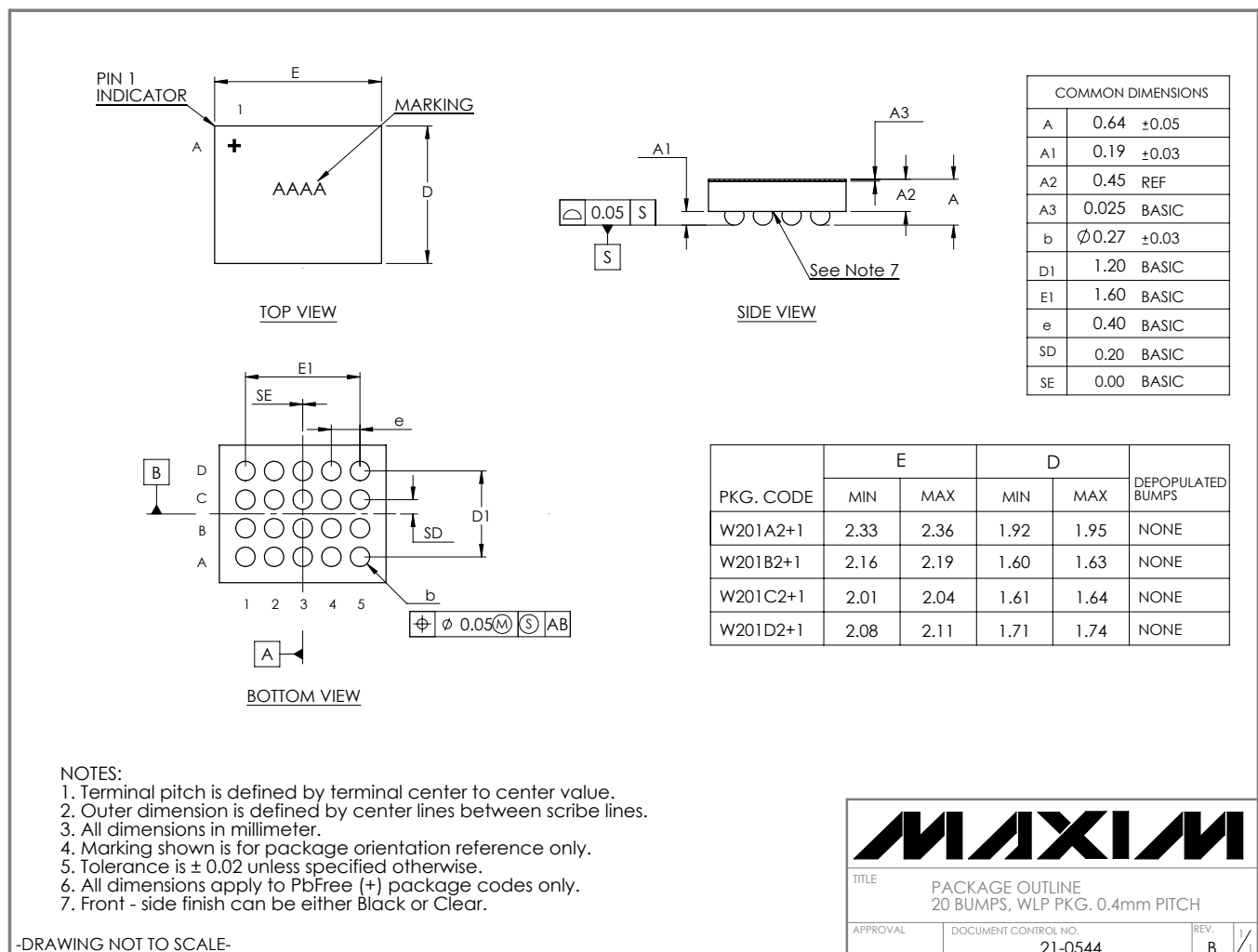

High-Efficiency, Low-Noise Audio Subsystem

Revision History

REVISION NUMBER	REVISION DATE	DESCRIPTION	PAGES CHANGED
0	9/11	Initial release	—

Maxim cannot assume responsibility for use of any circuitry other than circuitry entirely embodied in a Maxim product. No circuit patent licenses are implied. Maxim reserves the right to change the circuitry and specifications without notice at any time. The parametric values (min and max limits) shown in the Electrical Characteristics table are guaranteed. Other parametric values quoted in this data sheet are provided for guidance.

Maxim Integrated Products, 120 San Gabriel Drive, Sunnyvale, CA 94086 408-737-7600 _____ 48



Стандарт Электрон Связь

Мы молодая и активно развивающаяся компания в области поставок электронных компонентов. Мы поставляем электронные компоненты отечественного и импортного производства напрямую от производителей и с крупнейших складов мира.

Благодаря сотрудничеству с мировыми поставщиками мы осуществляем комплексные и плановые поставки широчайшего спектра электронных компонентов.

Собственная эффективная логистика и склад в обеспечивает надежную поставку продукции в точно указанные сроки по всей России.

Мы осуществляем техническую поддержку нашим клиентам и предпродажную проверку качества продукции. На все поставляемые продукты мы предоставляем гарантию .

Осуществляем поставки продукции под контролем ВП МО РФ на предприятия военно-промышленного комплекса России , а также работаем в рамках 275 ФЗ с открытием отдельных счетов в уполномоченном банке. Система менеджмента качества компании соответствует требованиям ГОСТ ISO 9001.

Минимальные сроки поставки, гибкие цены, неограниченный ассортимент и индивидуальный подход к клиентам являются основой для выстраивания долгосрочного и эффективного сотрудничества с предприятиями радиоэлектронной промышленности, предприятиями ВПК и научно-исследовательскими институтами России.

С нами вы становитесь еще успешнее!

Наши контакты:

Телефон: +7 812 627 14 35

Электронная почта: sales@st-electron.ru

Адрес: 198099, Санкт-Петербург,
Промышленная ул, дом № 19, литера Н,
помещение 100-Н Офис 331