

Resonant Switching Series

Reverse conducting IGBT with monolithic body diode

IHW30N135R3

Data sheet

Industrial Power Control

Reverse conducting IGBT with monolithic body diode

Features:

- Offers new higher breakdown voltage to 1350V for improved reliability
- Powerful monolithic body diode with low forward voltage designed for soft commutation only
- TRENCHSTOP™ technology offering:
 - very tight parameter distribution
 - high ruggedness, temperature stable behavior
 - low V_{CEsat}
 - easy parallel switching capability due to positive temperature coefficient in V_{CEsat}
- Low EMI
- Qualified according to JESD-022 for target applications
- Pb-free lead plating; RoHS compliant
- Halogen free (according to IEC 61249-2-21)
- Complete product spectrum and PSpice Models: <http://www.infineon.com/igbt/>

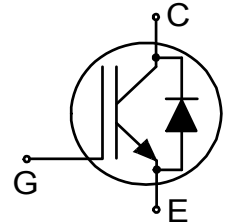

Applications:

- Inductive cooking
- Inverterized microwave ovens
- Resonant converters
- Soft switching applications

Package pin definition:

- Pin 1 - gate
- Pin 2 & backside - collector
- Pin 3 - emitter



Key Performance and Package Parameters

Type	V_{CE}	I_C	$V_{CEsat}, T_{vj}=25^{\circ}C$	T_{vjmax}	Marking	Package
IHW30N135R3	1350V	30A	1.65V	175°C	H30R1353	PG-TO247-3



Table of Contents

Description 2

Table of Contents 3

Maximum Ratings 4

Thermal Resistance 4

Electrical Characteristics 5

Electrical Characteristics Diagrams 7

Package Drawing13

Testing Conditions14

Revision History15

Disclaimer15

Maximum Ratings

For optimum lifetime and reliability, Infineon recommends operating conditions that do not exceed 80% of the maximum ratings stated in this datasheet.

Parameter	Symbol	Value	Unit
Collector-emitter voltage	V_{CE}	1350	V
DC collector current, limited by T_{vjmax} $T_C = 25^\circ\text{C}$ $T_C = 100^\circ\text{C}$	I_C	60.0 30.0	A
Pulsed collector current, t_p limited by T_{vjmax}	I_{Cpuls}	90.0	A
Turn off safe operating area $V_{CE} \leq 1350\text{V}$, $T_{vj} \leq 175^\circ\text{C}$	-	90.0	A
Diode forward current, limited by T_{vjmax} $T_C = 25^\circ\text{C}$ $T_C = 100^\circ\text{C}$	I_F	60.0 30.0	A
Diode pulsed current, t_p limited by T_{vjmax}	I_{Fpuls}	90.0	A
Gate-emitter voltage Transient Gate-emitter voltage ($t_p \leq 10\mu\text{s}$, $D < 0.010$)	V_{GE}	± 20 ± 25	V
Power dissipation $T_C = 25^\circ\text{C}$ Power dissipation $T_C = 100^\circ\text{C}$	P_{tot}	349.0 175.0	W
Operating junction temperature	T_{vj}	-40...+175	$^\circ\text{C}$
Storage temperature	T_{stg}	-55...+175	$^\circ\text{C}$
Soldering temperature, wave soldering 1.6mm (0.063in.) from case for 10s		260	$^\circ\text{C}$
Mounting torque, M3 screw Maximum of mounting processes: 3	M	0.6	Nm

Thermal Resistance

Parameter	Symbol	Conditions	Max. Value	Unit
Characteristic				
IGBT thermal resistance, junction - case	$R_{th(j-c)}$		0.43	K/W
Diode thermal resistance, junction - case	$R_{th(j-c)}$		0.43	K/W
Thermal resistance junction - ambient	$R_{th(j-a)}$		40	K/W

Electrical Characteristic, at $T_{vj} = 25^{\circ}\text{C}$, unless otherwise specified

Parameter	Symbol	Conditions	Value			Unit
			min.	typ.	max.	
Static Characteristic						
Collector-emitter breakdown voltage	$V_{(BR)CES}$	$V_{GE} = 0\text{V}, I_C = 0.50\text{mA}$	1350	-	-	V
Collector-emitter saturation voltage	V_{CEsat}	$V_{GE} = 15.0\text{V}, I_C = 30.0\text{A}$ $T_{vj} = 25^{\circ}\text{C}$ $T_{vj} = 125^{\circ}\text{C}$ $T_{vj} = 175^{\circ}\text{C}$	- - -	1.65 1.90 2.00	1.85 - -	V
Diode forward voltage	V_F	$V_{GE} = 0\text{V}, I_F = 30.0\text{A}$ $T_{vj} = 25^{\circ}\text{C}$ $T_{vj} = 125^{\circ}\text{C}$ $T_{vj} = 175^{\circ}\text{C}$	- - -	1.65 1.80 1.90	1.85 - -	V
Gate-emitter threshold voltage	$V_{GE(th)}$	$I_C = 0.75\text{mA}, V_{CE} = V_{GE}$	5.1	5.8	6.4	V
Zero gate voltage collector current	I_{CES}	$V_{CE} = 1350\text{V}, V_{GE} = 0\text{V}$ $T_{vj} = 25^{\circ}\text{C}$ $T_{vj} = 175^{\circ}\text{C}$	- -	- -	100.0 2500.0	μA
Gate-emitter leakage current	I_{GES}	$V_{CE} = 0\text{V}, V_{GE} = 20\text{V}$	-	-	100	nA
Transconductance	g_{fs}	$V_{CE} = 20\text{V}, I_C = 30.0\text{A}$	-	25.6	-	S
Integrated gate resistor	r_G			none		Ω

Electrical Characteristic, at $T_{vj} = 25^{\circ}\text{C}$, unless otherwise specified

Parameter	Symbol	Conditions	Value			Unit
			min.	typ.	max.	
Dynamic Characteristic						
Input capacitance	C_{ies}	$V_{CE} = 25\text{V}, V_{GE} = 0\text{V}, f = 1\text{MHz}$	-	2066	-	pF
Output capacitance	C_{oes}		-	67	-	
Reverse transfer capacitance	C_{res}		-	58	-	
Gate charge	Q_G	$V_{CC} = 1080\text{V}, I_C = 30.0\text{A},$ $V_{GE} = 15\text{V}$	-	263.0	-	nC
Internal emitter inductance measured 5mm (0.197 in.) from case	L_E		-	13.0	-	nH

Switching Characteristic, Inductive Load

Parameter	Symbol	Conditions	Value			Unit
			min.	typ.	max.	

IGBT Characteristic, at $T_{vj} = 25^{\circ}\text{C}$

Turn-off delay time	$t_{d(off)}$	$T_{vj} = 25^{\circ}\text{C},$ $V_{CC} = 600\text{V}, I_C = 30.0\text{A},$ $V_{GE} = 0.0/15.0\text{V},$ $R_{G(on)} = 10.0\Omega, R_{G(off)} = 10.0\Omega,$ $L_{\sigma} = 220\text{nH}, C_{\sigma} = 40\text{pF}$ L_{σ}, C_{σ} from Fig. E Energy losses include "tail" and diode reverse recovery.	-	337	-	ns
Fall time	t_f		-	47	-	ns
Turn-off energy	E_{off}		-	1.93	-	mJ
Turn-off energy, soft switching	E_{off}	$dv/dt = 150.0\text{V}/\mu\text{s}$	-	0.41	-	mJ

Switching Characteristic, Inductive Load

Parameter	Symbol	Conditions	Value			Unit
			min.	typ.	max.	
IGBT Characteristic, at $T_{vj} = 175^{\circ}\text{C}$						
Turn-off delay time	$t_{d(\text{off})}$	$T_{vj} = 175^{\circ}\text{C},$	-	410	-	ns
Fall time	t_f	$V_{CC} = 600\text{V}, I_C = 30.0\text{A},$ $V_{GE} = 0.0/15.0\text{V},$	-	100	-	ns
Turn-off energy	E_{off}	$R_{G(\text{on})} = 10.0\Omega, R_{G(\text{off})} = 10.0\Omega,$ $L\sigma = 220\text{nH}, C\sigma = 40\text{pF}$ $L\sigma, C\sigma$ from Fig. E Energy losses include "tail" and diode reverse recovery.	-	3.50	-	mJ
Turn-off energy, soft switching	E_{off}	$dv/dt = 150.0\text{V}/\mu\text{s}$	-	0.82	-	mJ

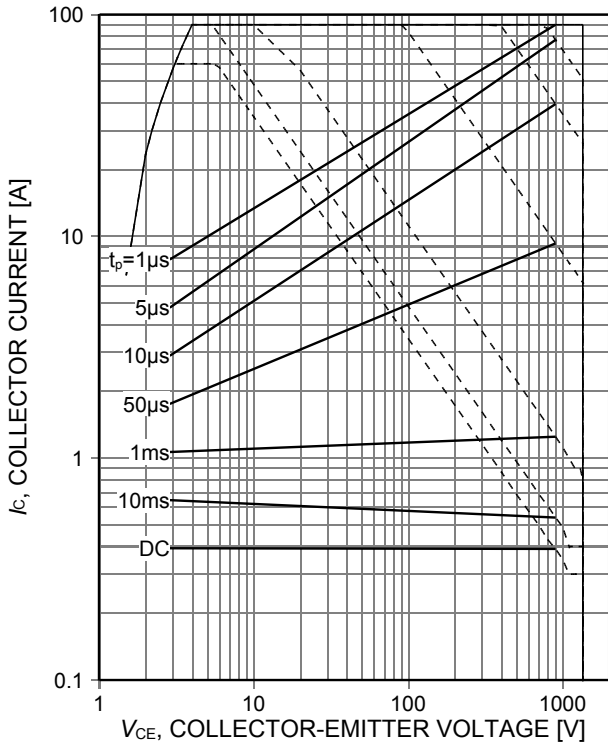

Figure 1. **Forward bias safe operating area**
($D=0$, $T_C=25^\circ\text{C}$, $T_{vj}\leq 175^\circ\text{C}$; $V_{GE}=15\text{V}$)

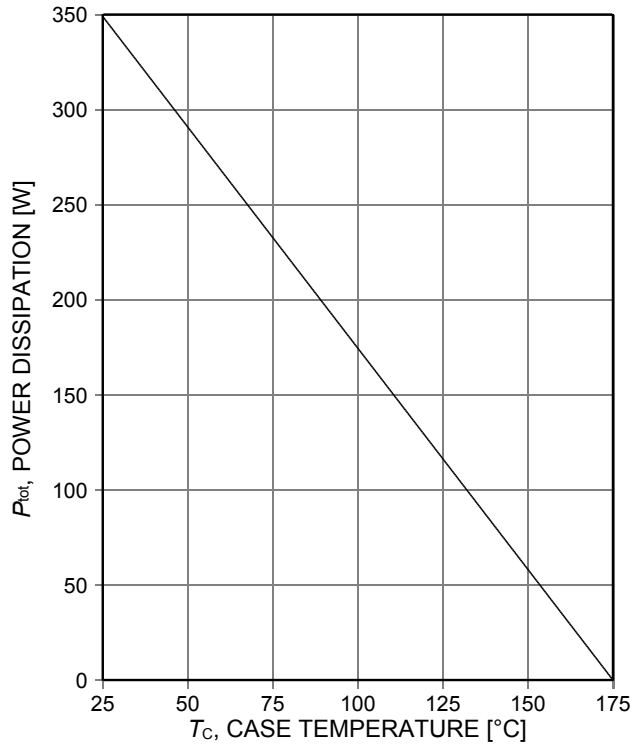

Figure 2. **Power dissipation as a function of case temperature**
($T_{vj}\leq 175^\circ\text{C}$)

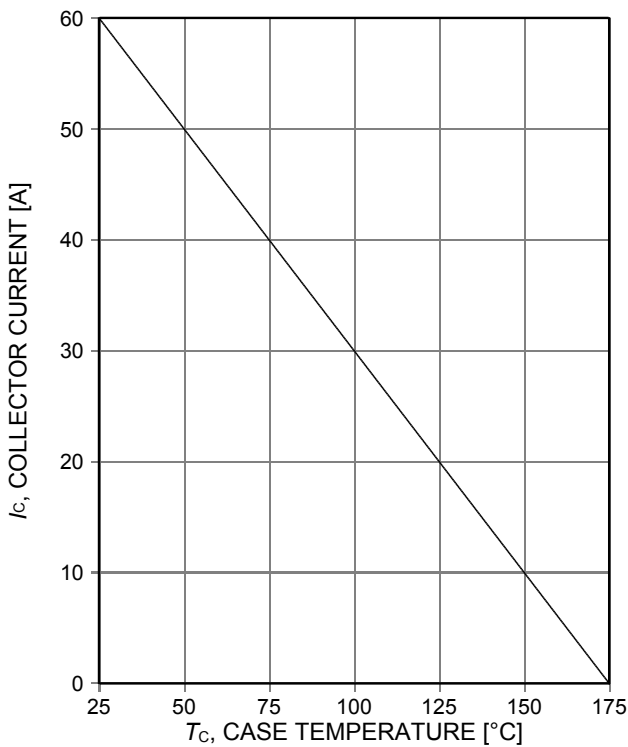

Figure 3. **Collector current as a function of case temperature**
($V_{GE}\geq 15\text{V}$, $T_{vj}\leq 175^\circ\text{C}$)

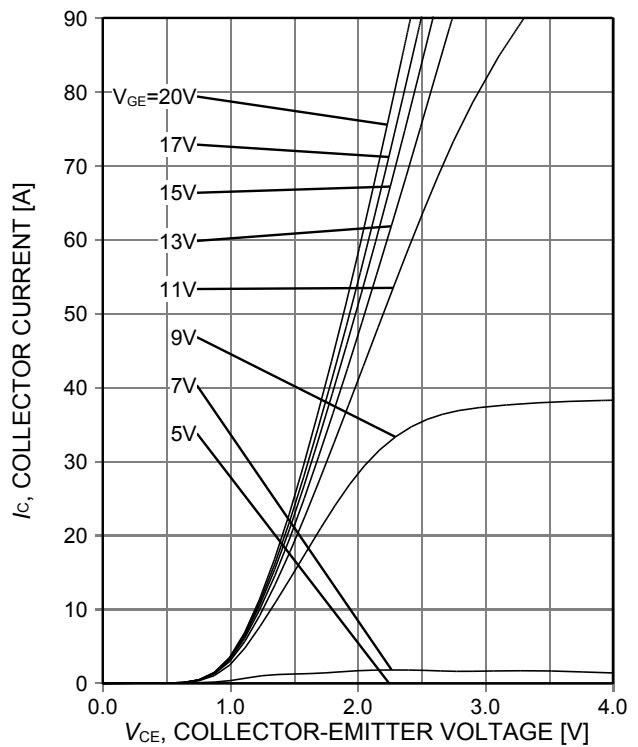

Figure 4. **Typical output characteristic**
($T_{vj}=25^\circ\text{C}$)

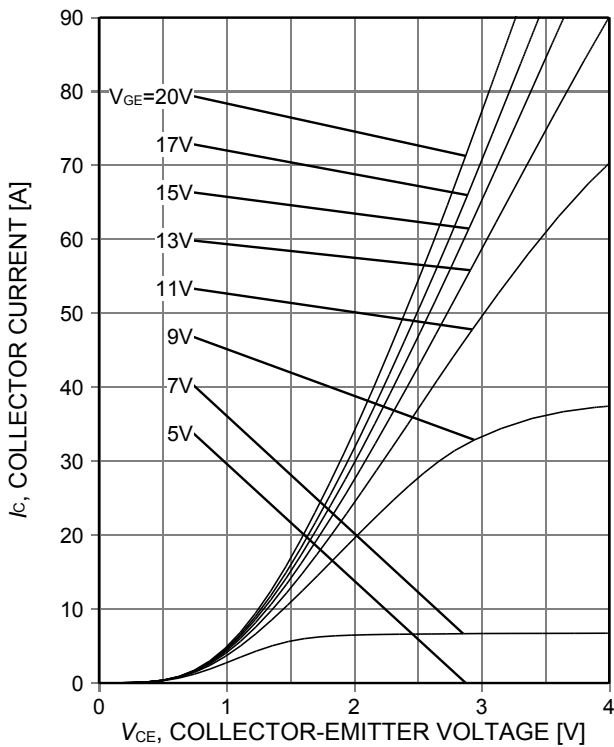

Figure 5. Typical output characteristic ($T_{vj}=175^{\circ}\text{C}$)

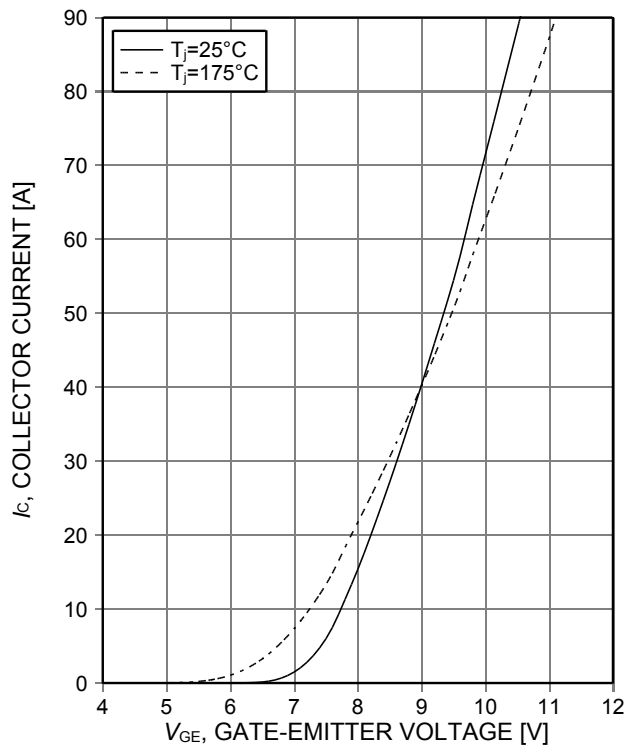

Figure 6. Typical transfer characteristic ($V_{CE}=20\text{V}$)

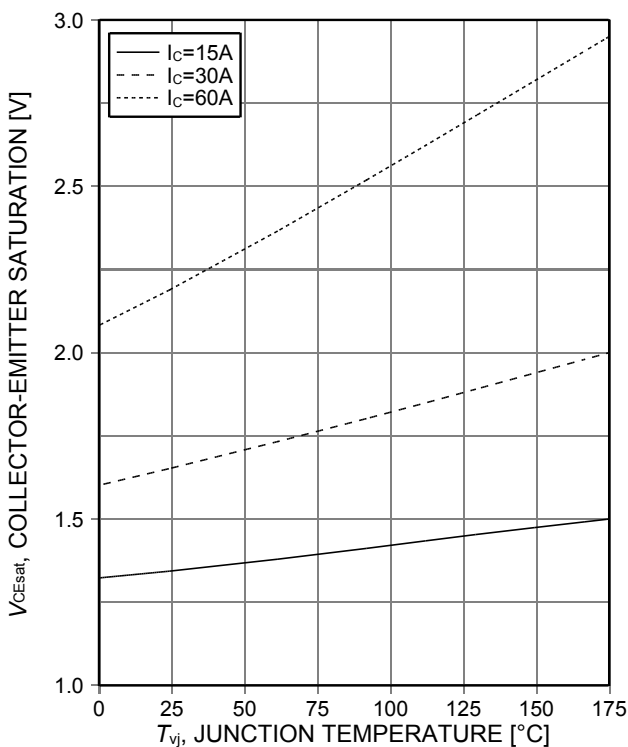

Figure 7. Typical collector-emitter saturation voltage as a function of junction temperature ($V_{GE}=15\text{V}$)

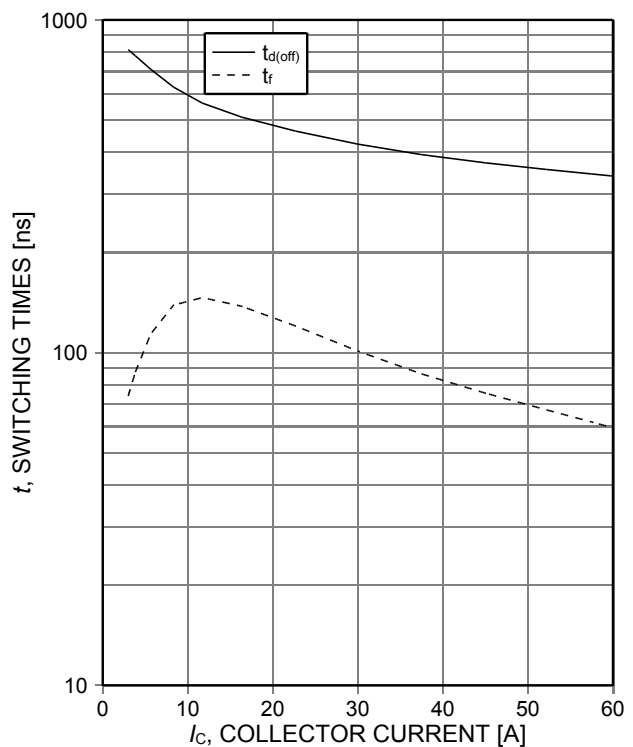

Figure 8. Typical switching times as a function of collector current (inductive load, $T_{vj}=175^{\circ}\text{C}$, $V_{CE}=600\text{V}$, $V_{GE}=0/15\text{V}$, $R_{G(on)}=10\Omega$, $R_{G(off)}=10\Omega$, dynamic test circuit in Figure E)

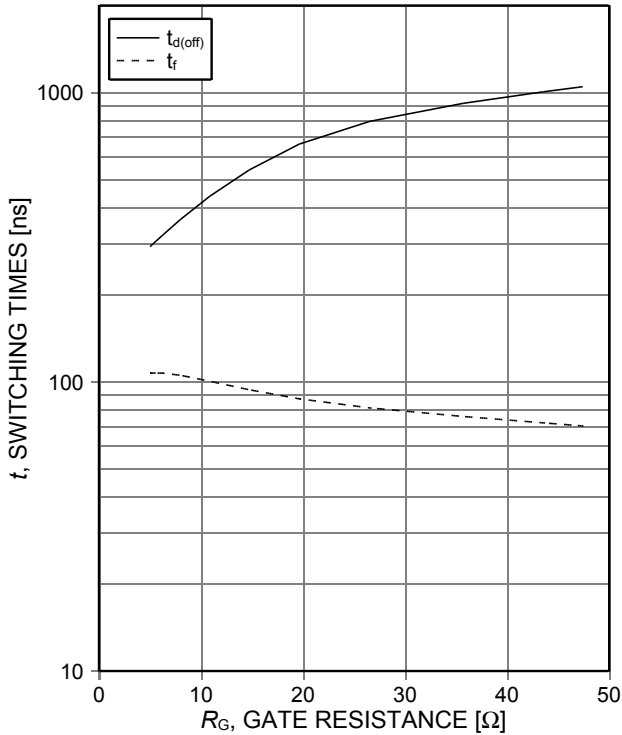

Figure 9. **Typical switching times as a function of gate resistance**
 (inductive load, $T_{vj}=175^{\circ}\text{C}$, $V_{CE}=600\text{V}$, $V_{GE}=0/15\text{V}$, $I_C=30\text{A}$, dynamic test circuit in Figure E)

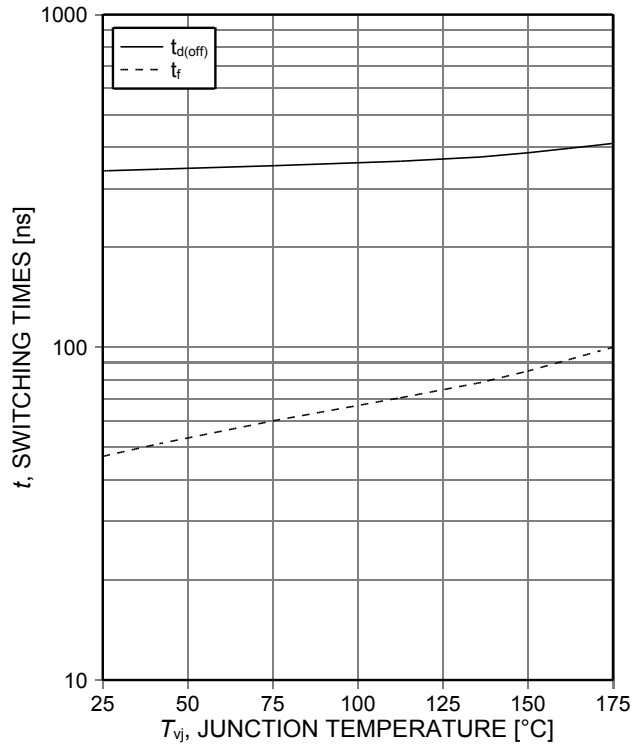

Figure 10. **Typical switching times as a function of junction temperature**
 (inductive load, $V_{CE}=600\text{V}$, $V_{GE}=0/15\text{V}$, $I_C=30\text{A}$, $R_{G(on)}=10\Omega$, $R_{G(off)}=10\Omega$, dynamic test circuit in Figure E)

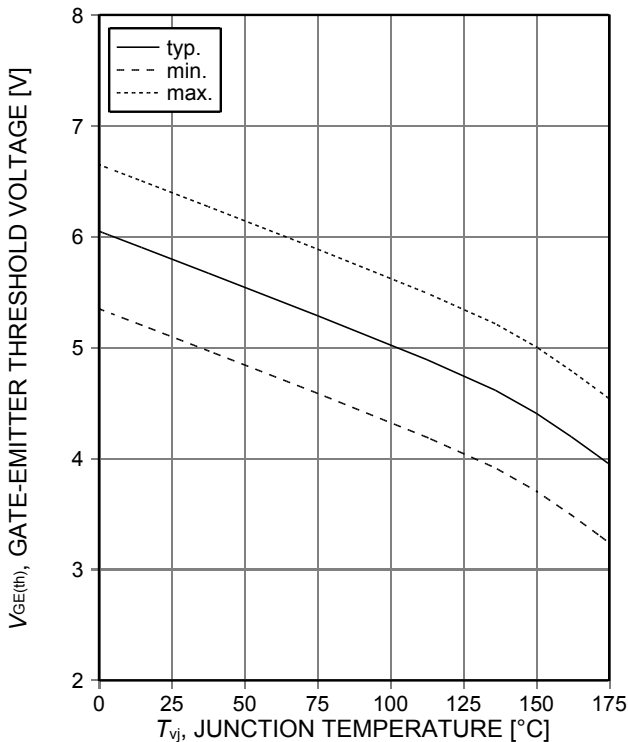

Figure 11. **Gate-emitter threshold voltage as a function of junction temperature**
 ($I_C=0.75\text{mA}$)

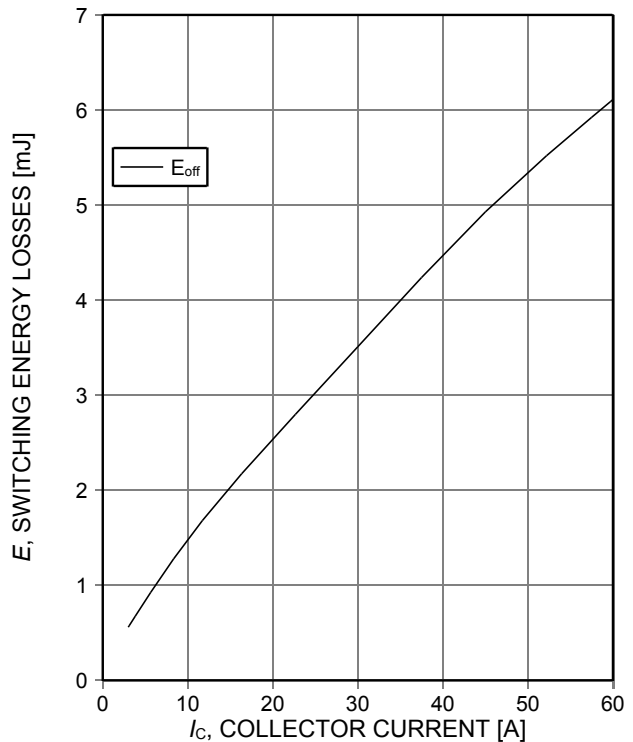

Figure 12. **Typical switching energy losses as a function of collector current**
 (inductive load, $T_{vj}=175^{\circ}\text{C}$, $V_{CE}=600\text{V}$, $V_{GE}=0/15\text{V}$, $R_{G(on)}=10\Omega$, $R_{G(off)}=10\Omega$, dynamic test circuit in Figure E)

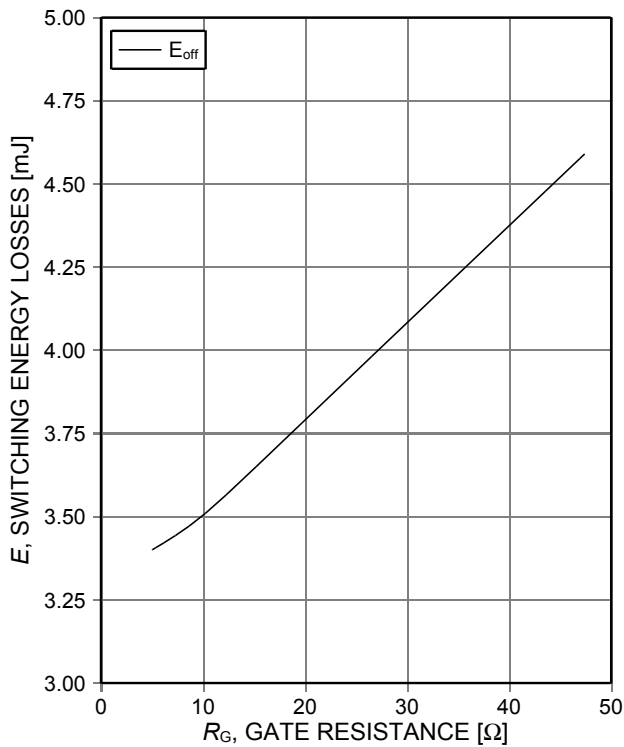

Figure 13. **Typical switching energy losses as a function of gate resistance**
 (inductive load, $T_{vj}=175^\circ\text{C}$, $V_{CE}=600\text{V}$, $V_{GE}=0/15\text{V}$, $I_C=30\text{A}$, dynamic test circuit in Figure E)

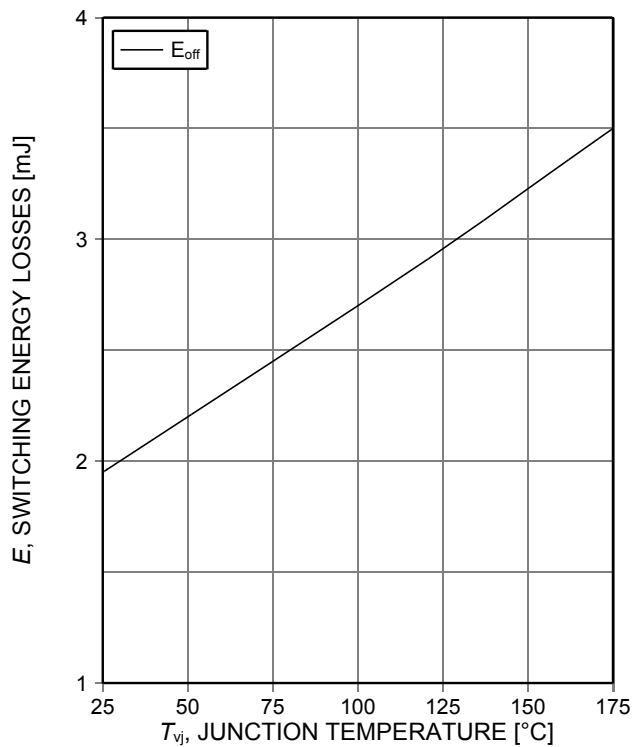

Figure 14. **Typical switching energy losses as a function of junction temperature**
 (inductive load, $V_{CE}=600\text{V}$, $V_{GE}=0/15\text{V}$, $I_C=30\text{A}$, $R_{G(on)}=10\Omega$, $R_{G(off)}=10\Omega$, dynamic test circuit in Figure E)

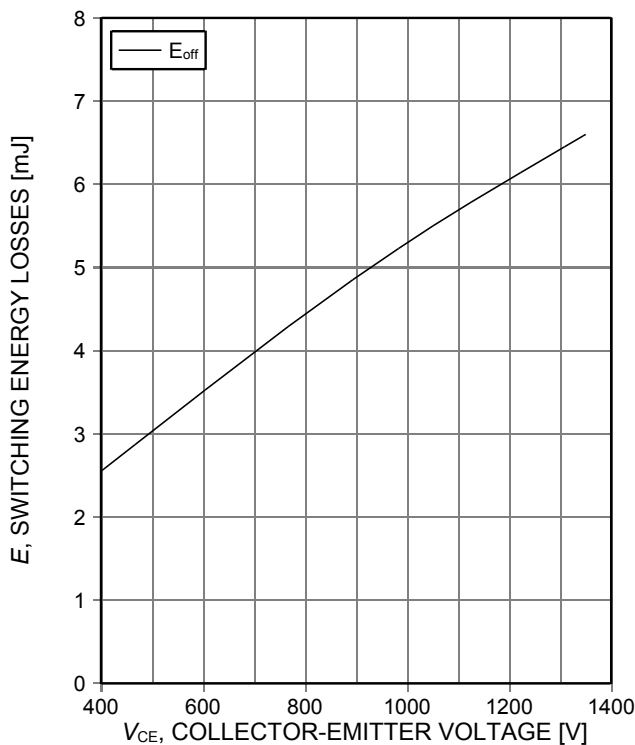

Figure 15. **Typical switching energy losses as a function of collector emitter voltage**
 (inductive load, $T_{vj}=175^\circ\text{C}$, $V_{GE}=0/15\text{V}$, $I_C=30\text{A}$, $R_{G(on)}=10\Omega$, $R_{G(off)}=10\Omega$, dynamic test circuit in Figure E)

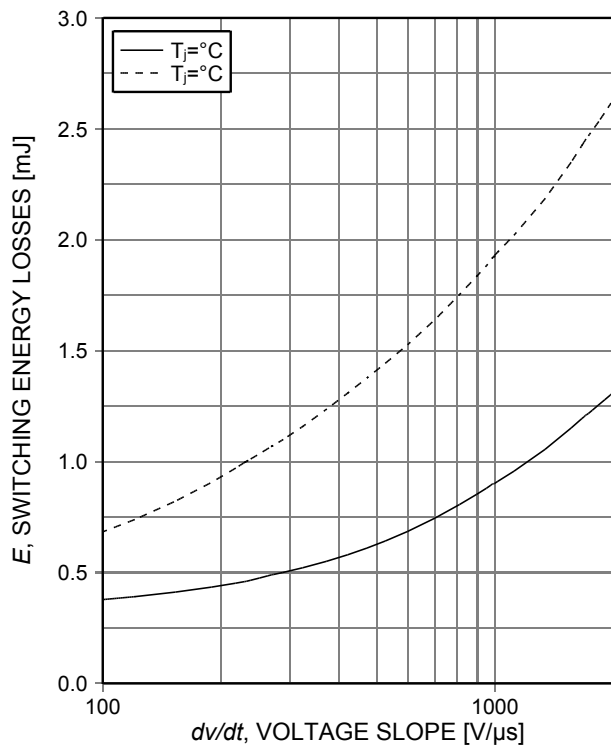

Figure 16. **Typical turn off switching energy loss for soft switching**
 (inductive load, $T_{vj}=175^\circ\text{C}$, $V_{GE}=0/15\text{V}$, $I_C=30\text{A}$, $R_G=10\Omega$, dynamic test circuit in Figure E)

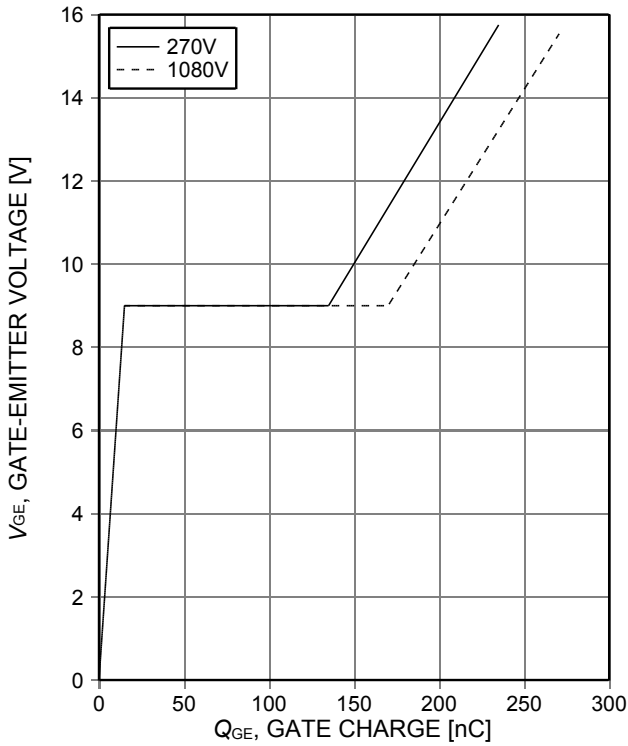

Figure 17. **Typical gate charge**
($I_C=30A$)

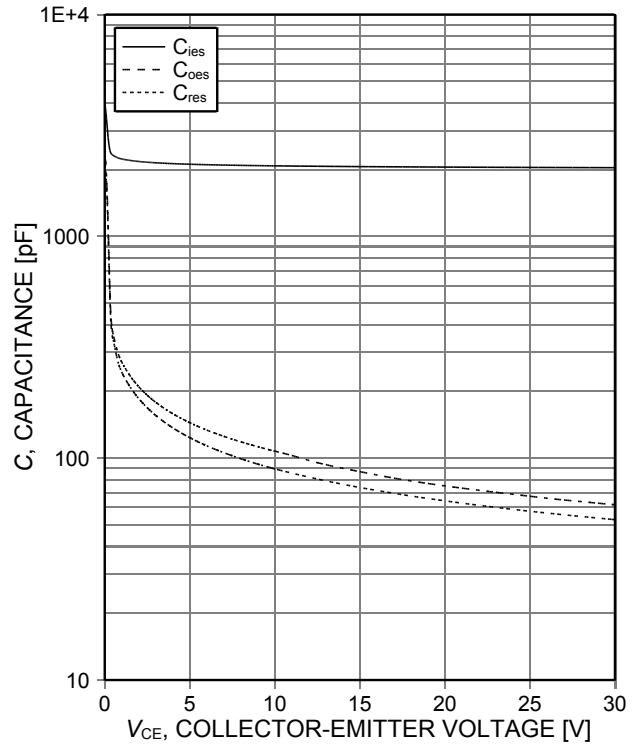

Figure 18. **Typical capacitance as a function of collector-emitter voltage**
($V_{GE}=0V$, $f=1MHz$)

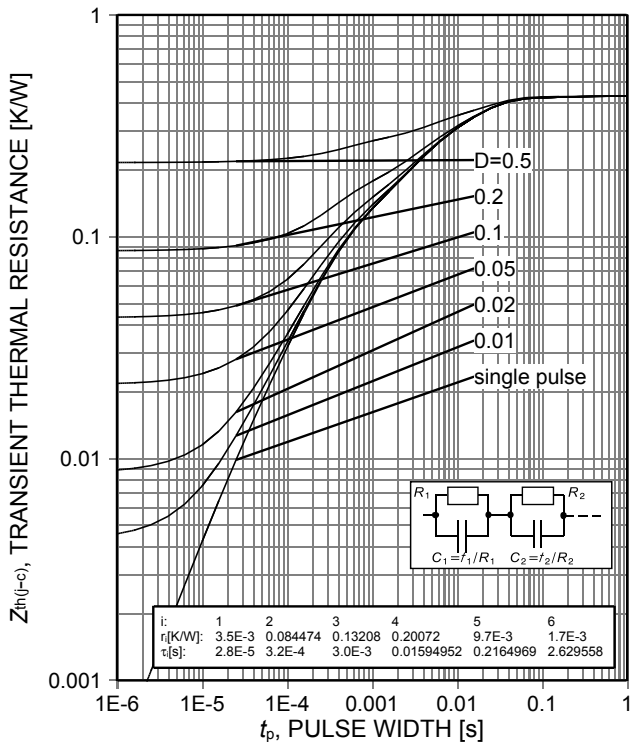

Figure 19. **IGBT transient thermal resistance**
($D=t_p/T$)

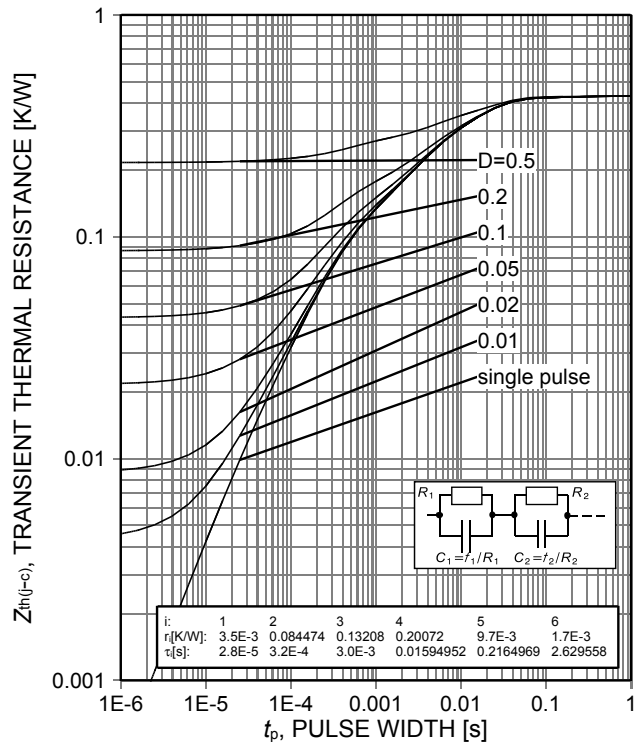

Figure 20. **Diode transient thermal impedance as a function of pulse width**
($D=t_p/T$)

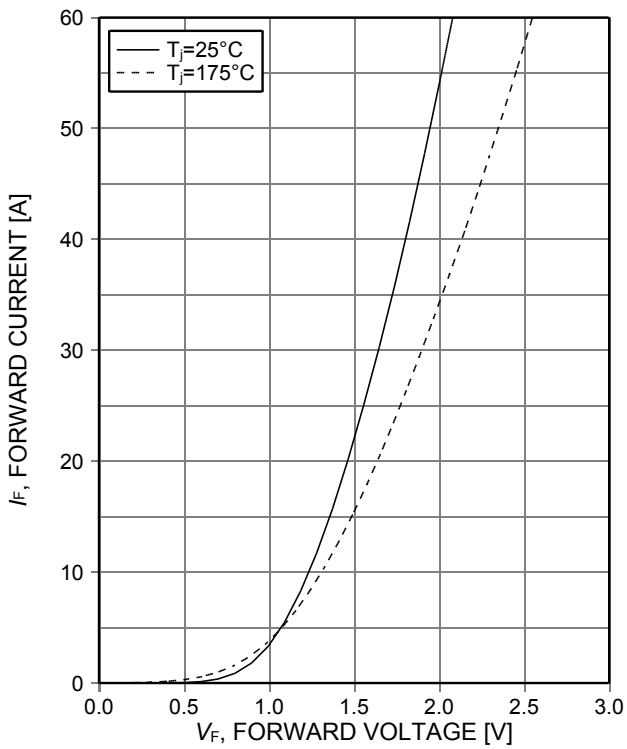

Figure 21. Typical diode forward current as a function of forward voltage

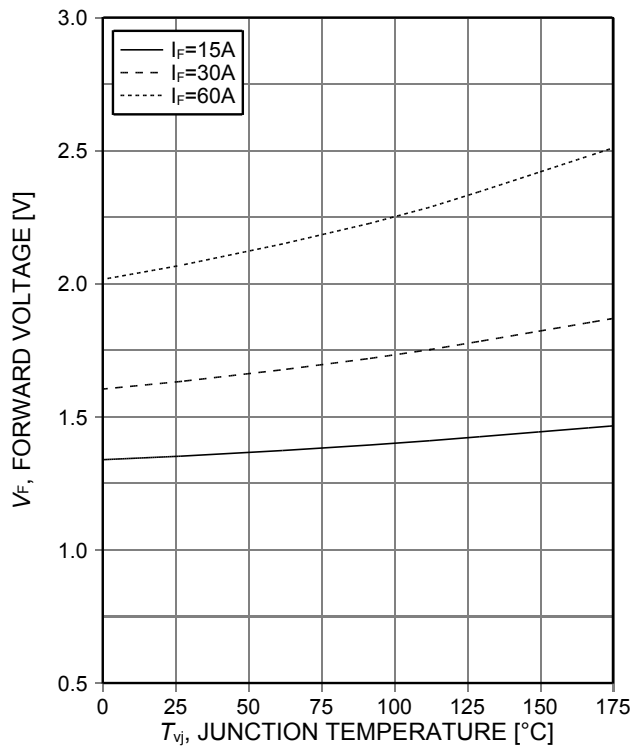
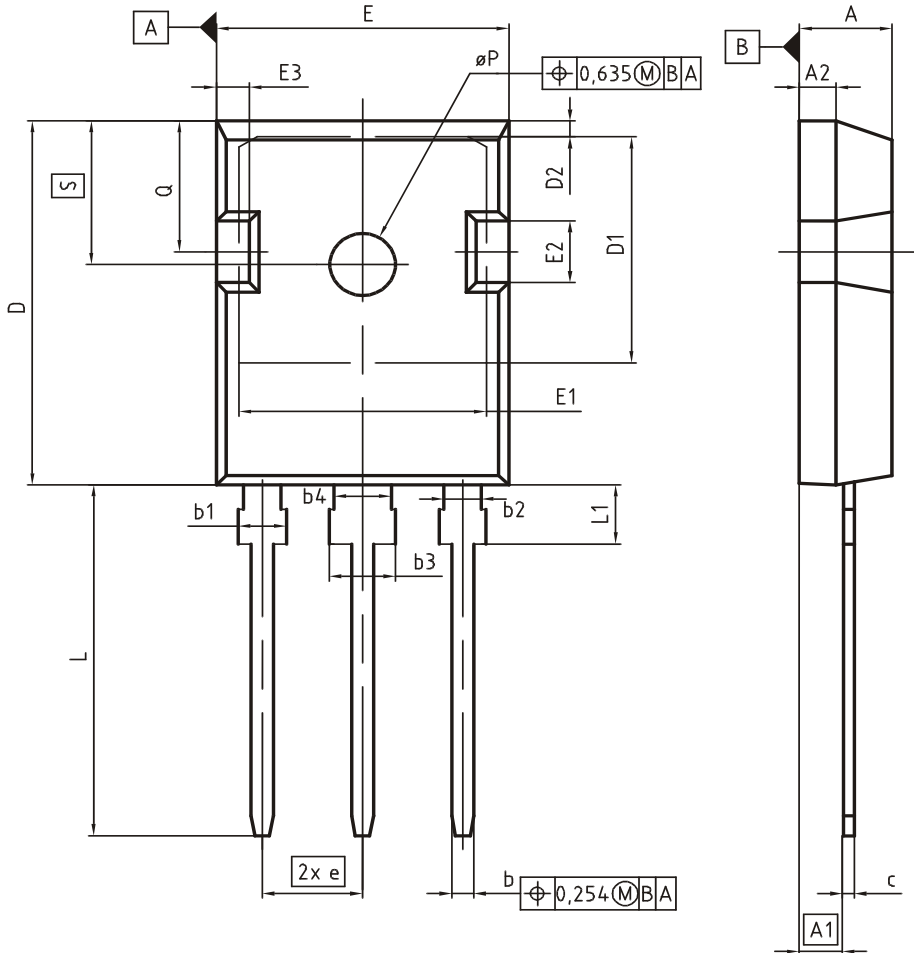

Figure 22. Typical diode forward voltage as a function of junction temperature

PG-TO247-3



DIM	MILLIMETERS		INCHES	
	MIN	MAX	MIN	MAX
A	4.83	5.21	0.190	0.205
A1	2.27	2.54	0.089	0.100
A2	1.85	2.16	0.073	0.085
b	1.07	1.33	0.042	0.052
b1	1.90	2.41	0.075	0.095
b2	1.90	2.16	0.075	0.085
b3	2.87	3.38	0.113	0.133
b4	2.87	3.13	0.113	0.123
c	0.55	0.68	0.022	0.027
D	20.80	21.10	0.819	0.831
D1	16.25	17.65	0.640	0.695
D2	0.95	1.35	0.037	0.053
E	15.70	16.13	0.618	0.635
E1	13.10	14.15	0.516	0.557
E2	3.68	5.10	0.145	0.201
E3	1.00	2.60	0.039	0.102
e	5.44 (BSC)		0.214 (BSC)	
N	3		3	
L	19.80	20.32	0.780	0.800
L1	4.10	4.47	0.161	0.176
øP	3.50	3.70	0.138	0.146
Q	5.49	6.00	0.216	0.236
S	6.04	6.30	0.238	0.248

DOCUMENT NO.
Z8B00003327

SCALE
0 5 5 7.5mm

EUROPEAN PROJECTION

ISSUE DATE
09-07-2010

REVISION
05

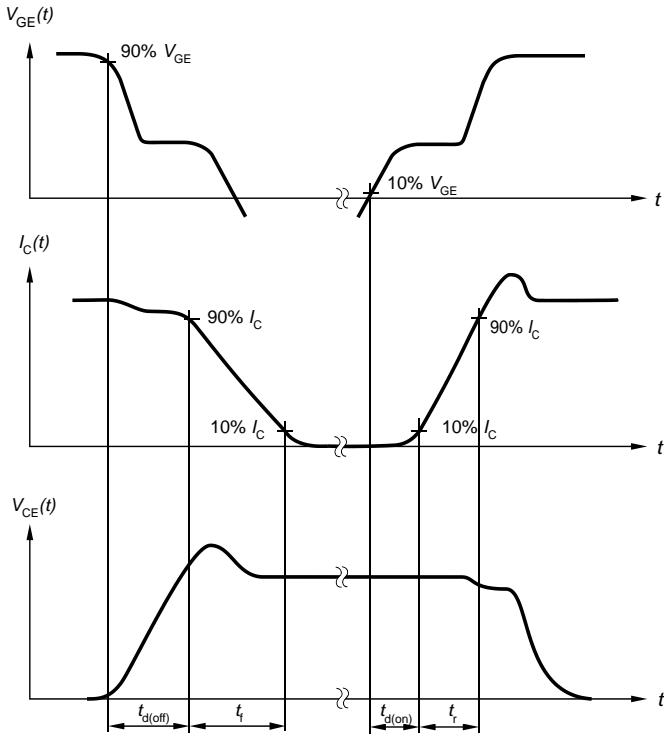

Figure A. Definition of switching times

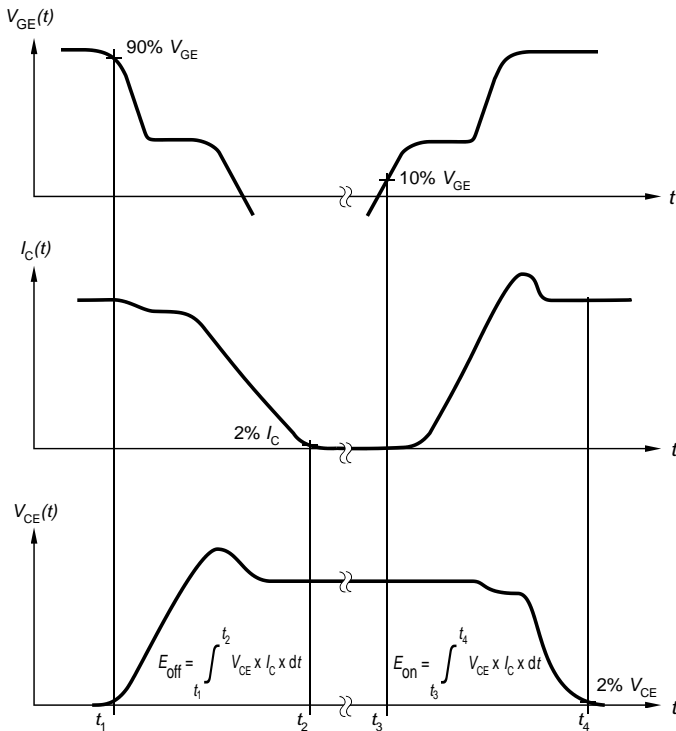

Figure B. Definition of switching losses

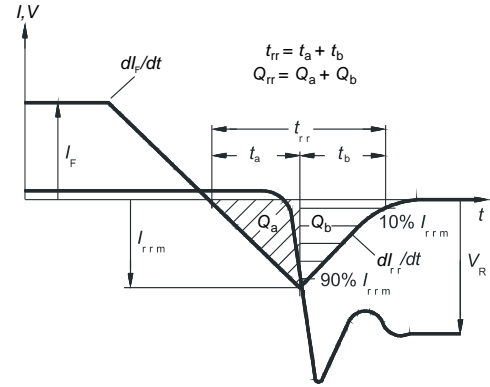

Figure C. Definition of diode switching characteristics

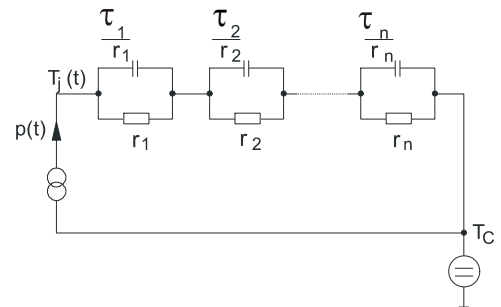

Figure D. Thermal equivalent circuit

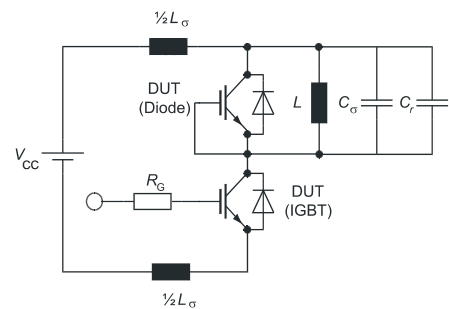

Figure E. Dynamic test circuit
Parasitic inductance L_{σ} ,
parasitic capacitor C_{σ} ,
relief capacitor C_r ,
(only for ZVT switching)

Revision History

IHW30N135R3

Revision: 2015-01-26, Rev. 2.2

Previous Revision

Revision	Date	Subjects (major changes since last revision)
2.1	2012-10-12	Final data sheet
2.2	2015-01-26	Minor changes

We Listen to Your Comments

Any information within this document that you feel is wrong, unclear or missing at all?

Your feedback will help us to continuously improve the quality of this document.

Please send your proposal (including a reference to this document) to: erratum@infineon.com

Published by

Infineon Technologies AG

81726 Munich, Germany

81726 München, Germany

© 2015 Infineon Technologies AG

All Rights Reserved.

Legal Disclaimer

The information given in this document shall in no event be regarded as a guarantee of conditions or characteristics.

With respect to any examples or hints given herein, any typical values stated herein and/or any information regarding the application of the device, Infineon Technologies hereby disclaims any and all warranties and liabilities of any kind, including without limitation, warranties of non-infringement of intellectual property rights of any third party.

Information

For further information on technology, delivery terms and conditions and prices, please contact the nearest Infineon Technologies Office (www.infineon.com).

Warnings

Due to technical requirements, components may contain dangerous substances. For information on the types in question, please contact the nearest Infineon Technologies Office.

The Infineon Technologies component described in this Data Sheet may be used in life-support devices or systems and/or automotive, aviation and aerospace applications or systems only with the express written approval of Infineon Technologies, if a failure of such components can reasonably be expected to cause the failure of that life-support, automotive, aviation and aerospace device or system or to affect the safety or effectiveness of that device or system. Life support devices or systems are intended to be implanted in the human body or to support and/or maintain and sustain and/or protect human life. If they fail, it is reasonable to assume that the health of the user or other persons may be endangered.



**Стандарт
Электрон
Связь**

Мы молодая и активно развивающаяся компания в области поставок электронных компонентов. Мы поставляем электронные компоненты отечественного и импортного производства напрямую от производителей и с крупнейших складов мира.

Благодаря сотрудничеству с мировыми поставщиками мы осуществляем комплексные и плановые поставки широчайшего спектра электронных компонентов.

Собственная эффективная логистика и склад в обеспечивает надежную поставку продукции в точно указанные сроки по всей России.

Мы осуществляем техническую поддержку нашим клиентам и предпродажную проверку качества продукции. На все поставляемые продукты мы предоставляем гарантию .

Осуществляем поставки продукции под контролем ВП МО РФ на предприятия военно-промышленного комплекса России , а также работаем в рамках 275 ФЗ с открытием отдельных счетов в уполномоченном банке. Система менеджмента качества компании соответствует требованиям ГОСТ ISO 9001.

Минимальные сроки поставки, гибкие цены, неограниченный ассортимент и индивидуальный подход к клиентам являются основой для выстраивания долгосрочного и эффективного сотрудничества с предприятиями радиоэлектронной промышленности, предприятиями ВПК и научно-исследовательскими институтами России.

С нами вы становитесь еще успешнее!

Наши контакты:

Телефон: +7 812 627 14 35

Электронная почта: sales@st-electron.ru

Адрес: 198099, Санкт-Петербург,
Промышленная ул, дом № 19, литера Н,
помещение 100-Н Офис 331