

*Single switch
Series & parallel diodes
MOSFET Power Module*

$V_{DSS} = 500V$
 $R_{DSon} = 13m\Omega \text{ typ @ } T_j = 25^\circ C$
 $I_D = 335A \text{ @ } T_c = 25^\circ C$

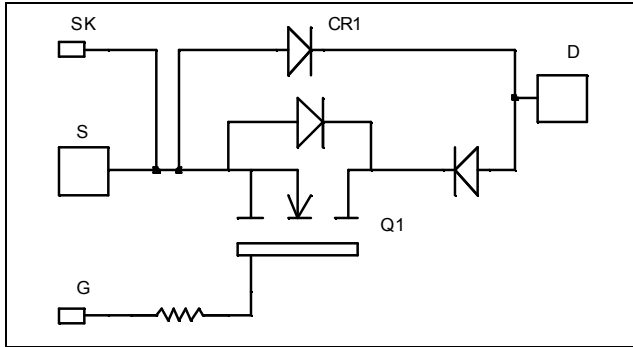

Application

- Welding converters
- Switched Mode Power Supplies
- Uninterruptible Power Supplies
- Motor control

Features

- Power MOS 7[®] MOSFETs
 - Low R_{DSon}
 - Low input and Miller capacitance
 - Low gate charge
 - Avalanche energy rated
 - Very rugged
- Kelvin source for easy drive
- Very low stray inductance
 - Symmetrical design
 - M5 power connectors
- High level of integration
- AlN substrate for improved thermal performance

Benefits

- Outstanding performance at high frequency operation
- Direct mounting to heatsink (isolated package)
- Low junction to case thermal resistance
- Low profile
- RoHS Compliant

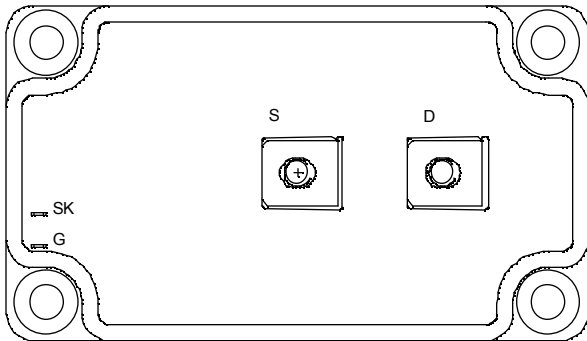

Absolute maximum ratings

Symbol	Parameter	Max ratings	Unit
V_{DSS}	Drain - Source Breakdown Voltage	500	V
I_D	Continuous Drain Current	$T_c = 25^\circ C$	335
		$T_c = 80^\circ C$	250
I_{DM}	Pulsed Drain current	1340	
V_{GS}	Gate - Source Voltage	± 30	V
R_{DSon}	Drain - Source ON Resistance	15	m Ω
P_D	Maximum Power Dissipation	$T_c = 25^\circ C$	3290
I_{AR}	Avalanche current (repetitive and non repetitive)	71	A
E_{AR}	Repetitive Avalanche Energy	50	mJ
E_{AS}	Single Pulse Avalanche Energy	3000	

 **CAUTION:** These Devices are sensitive to Electrostatic Discharge. Proper Handling Procedures Should Be Followed. See application note APT0502 on www.microsemi.com

All ratings @ $T_j = 25^\circ\text{C}$ unless otherwise specified

Electrical Characteristics

Symbol	Characteristic	Test Conditions	Min	Typ	Max	Unit
I_{DSS}	Zero Gate Voltage Drain Current	$V_{GS} = 0\text{V}, V_{DS} = 500\text{V}$			400	μA
		$V_{GS} = 0\text{V}, V_{DS} = 400\text{V}$			2000	
$R_{DS(on)}$	Drain – Source on Resistance	$V_{GS} = 10\text{V}, I_D = 167.5\text{A}$		13	15	$\text{m}\Omega$
$V_{GS(th)}$	Gate Threshold Voltage	$V_{GS} = V_{DS}, I_D = 20\text{mA}$	3		5	V
I_{GSS}	Gate – Source Leakage Current	$V_{GS} = \pm 30\text{V}, V_{DS} = 0\text{V}$			± 300	nA

Dynamic Characteristics

Symbol	Characteristic	Test Conditions	Min	Typ	Max	Unit
C_{iss}	Input Capacitance	$V_{GS} = 0\text{V}$		42.2		nF
C_{oss}	Output Capacitance	$V_{DS} = 25\text{V}$		8.24		
C_{rss}	Reverse Transfer Capacitance	$f = 1\text{MHz}$		0.42		
Q_g	Total gate Charge	$V_{GS} = 10\text{V}$		800		nC
Q_{gs}	Gate – Source Charge	$V_{Bus} = 250\text{V}$		200		
Q_{gd}	Gate – Drain Charge	$I_D = 335\text{A}$		420		
$T_{d(on)}$	Turn-on Delay Time	Inductive switching @ 125°C $V_{GS} = 15\text{V}$ $V_{Bus} = 333\text{V}$ $I_D = 335\text{A}$ $R_G = 0.8\Omega$		21		ns
T_r	Rise Time			42		
$T_{d(off)}$	Turn-off Delay Time			96		
T_f	Fall Time			100		
E_{on}	Turn-on Switching Energy	Inductive switching @ 25°C $V_{GS} = 15\text{V}, V_{Bus} = 333\text{V}$ $I_D = 335\text{A}, R_G = 0.8\Omega$		4		mJ
E_{off}	Turn-off Switching Energy			4.16		
E_{on}	Turn-on Switching Energy	Inductive switching @ 125°C $V_{GS} = 15\text{V}, V_{Bus} = 333\text{V}$ $I_D = 335\text{A}, R_G = 0.8\Omega$		6.32		mJ
E_{off}	Turn-off Switching Energy			4.64		

Series diode ratings and characteristics

Symbol	Characteristic	Test Conditions	Min	Typ	Max	Unit
V_{RRM}	Maximum Peak Repetitive Reverse Voltage		200			V
I_{RM}	Maximum Reverse Leakage Current	$V_R = 200\text{V}$	$T_j = 25^\circ\text{C}$		750	μA
			$T_j = 125^\circ\text{C}$		1000	
I_F	DC Forward Current			240		A
V_F	Diode Forward Voltage	$I_F = 240\text{A}$		1.1	1.15	V
		$I_F = 480\text{A}$		1.4		
		$I_F = 240\text{A}$	$T_j = 125^\circ\text{C}$	0.9		
t_{rr}	Reverse Recovery Time	$I_F = 240\text{A}$ $V_R = 133\text{V}$	$T_j = 25^\circ\text{C}$	31		ns
			$T_j = 125^\circ\text{C}$	60		
Q_{rr}	Reverse Recovery Charge	$di/dt = 800\text{A}/\mu\text{s}$	$T_j = 25^\circ\text{C}$	240		nC
			$T_j = 125^\circ\text{C}$	1000		

Parallel diode ratings and characteristics

<i>Symbol</i>	<i>Characteristic</i>	<i>Test Conditions</i>		<i>Min</i>	<i>Typ</i>	<i>Max</i>	<i>Unit</i>
V_{RRM}	Maximum Peak Repetitive Reverse Voltage			600			V
I_{RM}	Maximum Reverse Leakage Current	$V_R=600V$	$T_j = 25^\circ C$			1500	μA
			$T_j = 125^\circ C$			3000	
I_F	DC Forward Current	$T_c = 70^\circ C$			360		A
V_F	Diode Forward Voltage	$I_F = 360A$			1.6	1.8	V
		$I_F = 720A$			1.9		
		$I_F = 360A$	$T_j = 125^\circ C$		1.4		
t_{rr}	Reverse Recovery Time	$I_F = 360A$ $V_R = 400V$ $di/dt = 1000A/\mu s$	$T_j = 25^\circ C$		130		ns
			$T_j = 125^\circ C$		170		
Q_{rr}	Reverse Recovery Charge	$I_F = 360A$ $V_R = 400V$ $di/dt = 1000A/\mu s$	$T_j = 25^\circ C$		1.32		μC
			$T_j = 125^\circ C$		5.5		

Thermal and package characteristics

<i>Symbol</i>	<i>Characteristic</i>			<i>Min</i>	<i>Typ</i>	<i>Max</i>	<i>Unit</i>
R_{thJC}	Junction to Case Thermal Resistance	Transistor				0.038	$^\circ C/W$
		Series diode				0.23	
		Parallel diode				0.16	
V_{ISOL}	RMS Isolation Voltage, any terminal to case $t=1$ min, $I_{isol}<1mA$, 50/60Hz			2500			V
T_j	Operating junction temperature range			-40		150	$^\circ C$
T_{STG}	Storage Temperature Range			-40		125	
T_C	Operating Case Temperature			-40		100	
Torque	Mounting torque	To heatsink	M6	3		5	N.m
		For terminals	M5	2		3.5	
Wt	Package Weight					280	g

SP6 Package outline (dimensions in mm)

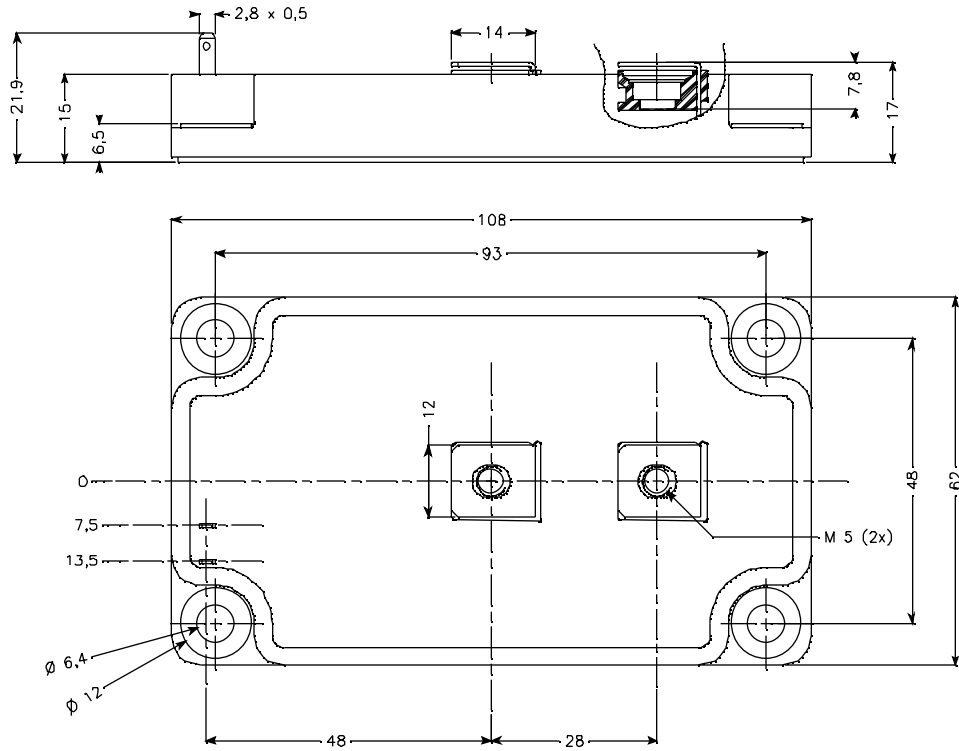

See application note APT0601 - Mounting Instructions for SP6 Power Modules on www.microsemi.com

Typical Performance Curve

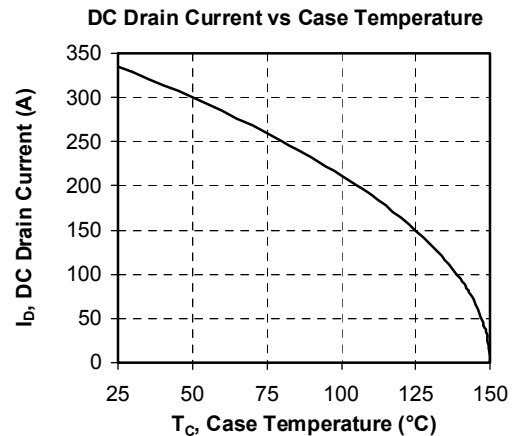
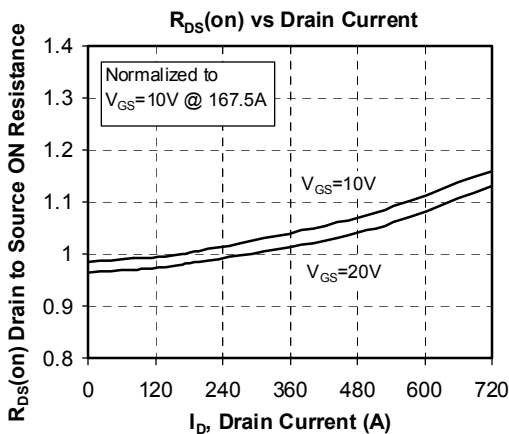
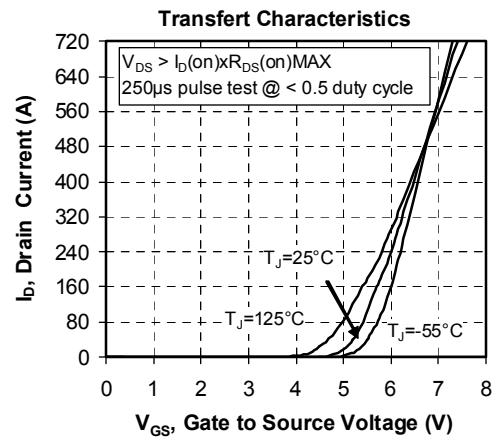
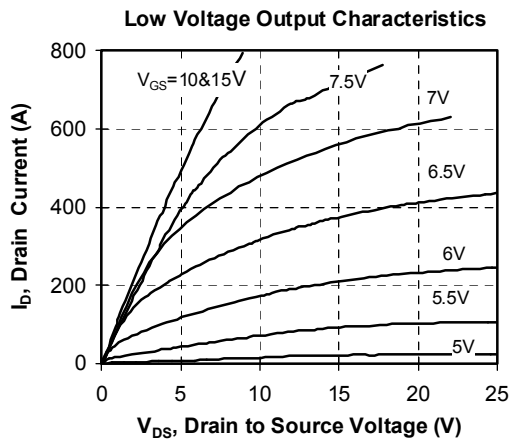
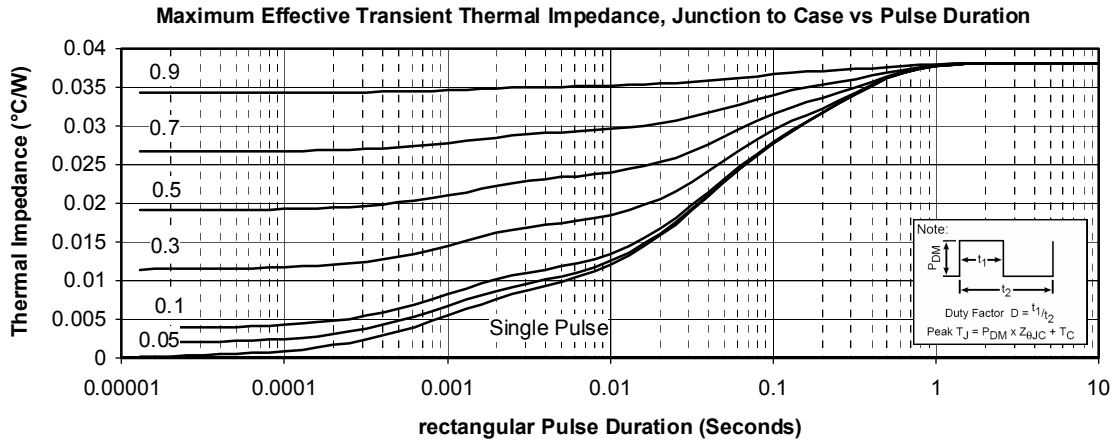

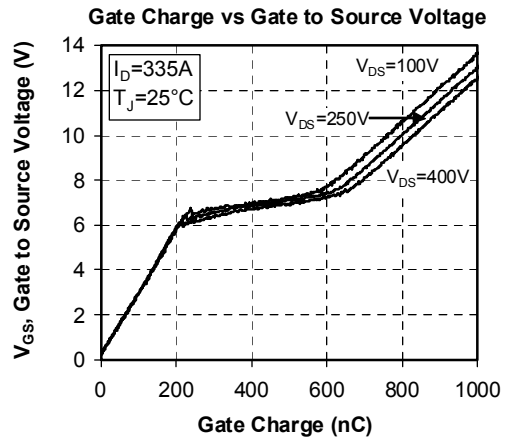
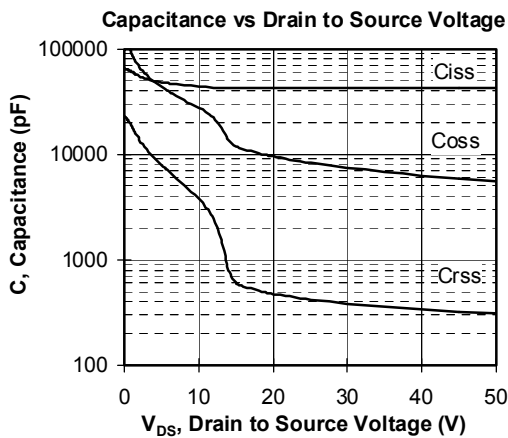
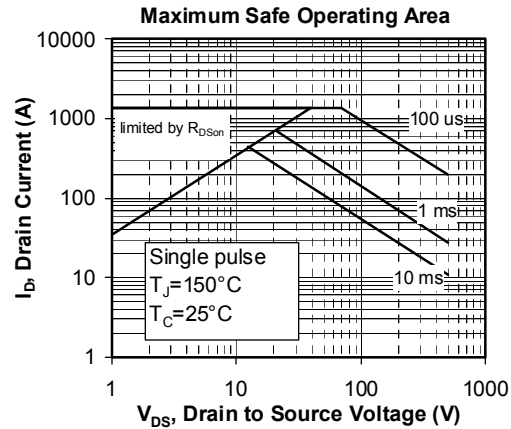
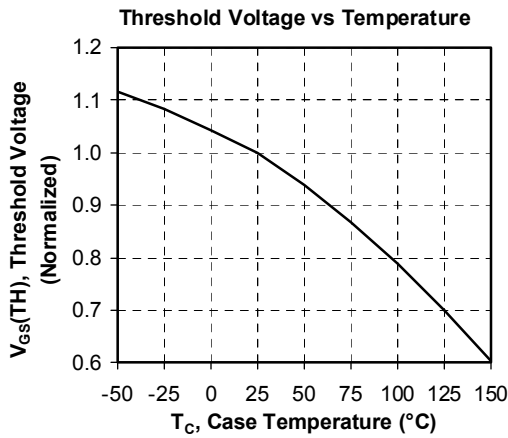
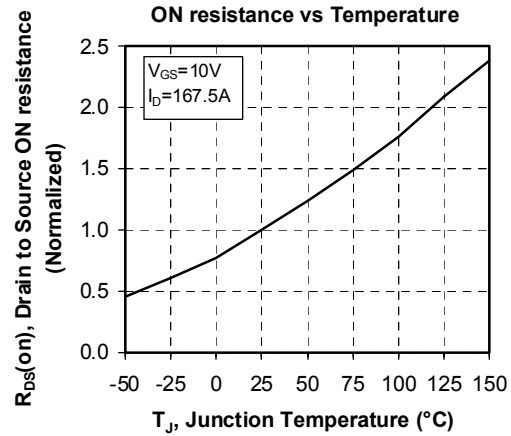
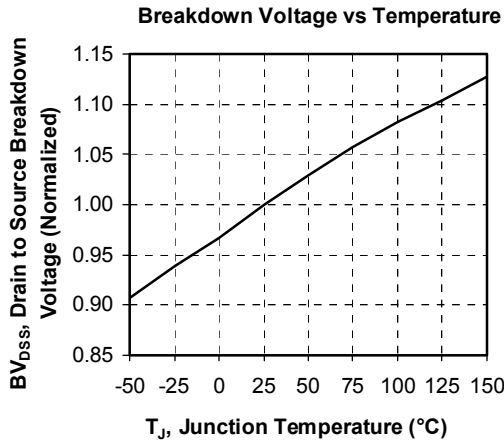

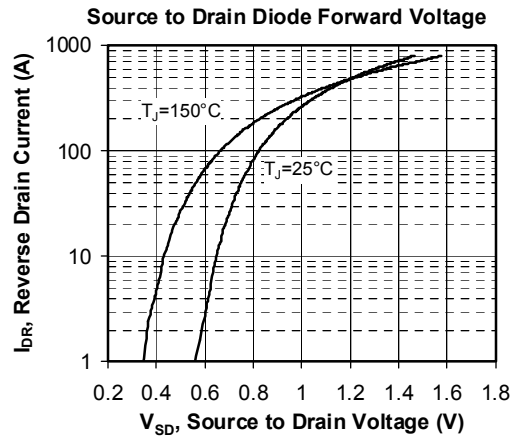
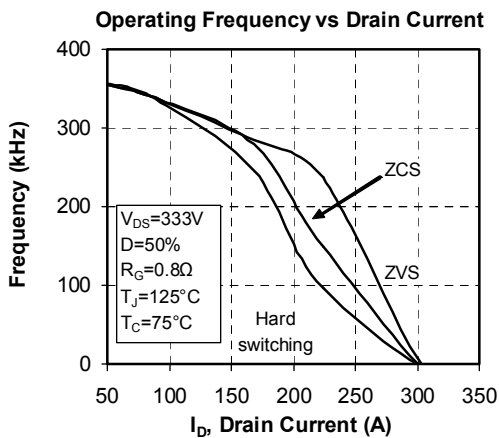
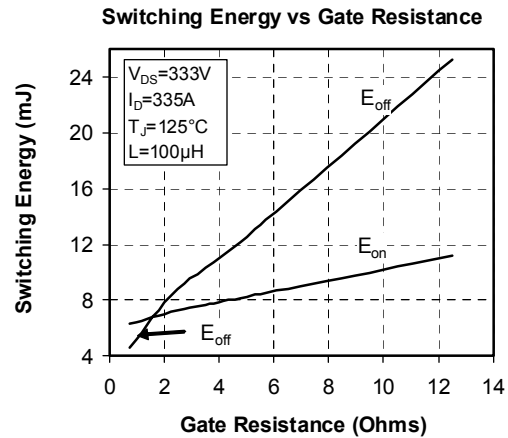
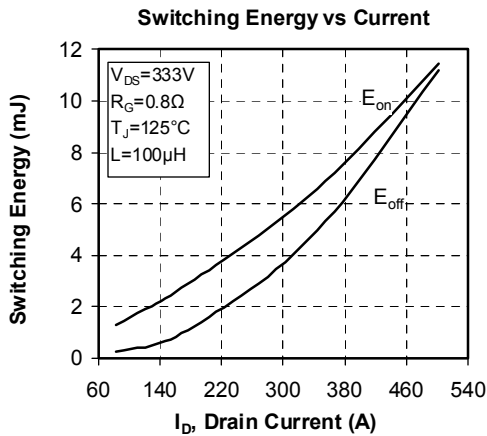
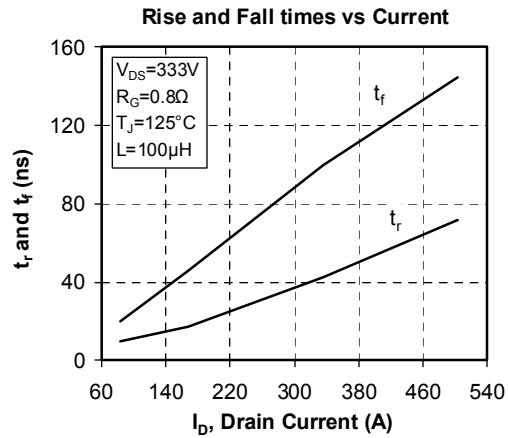
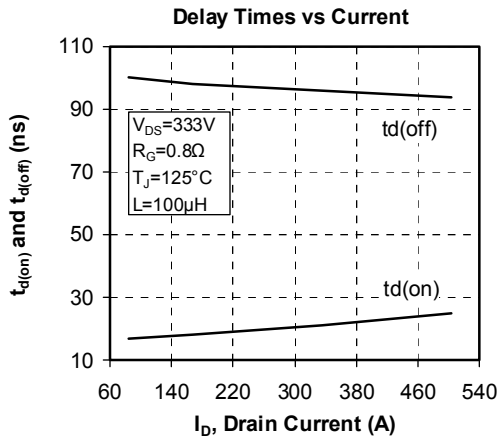

Microsemi reserves the right to change, without notice, the specifications and information contained herein

Microsemi's products are covered by one or more of U.S. patents 4,895,810 5,045,903 5,089,434 5,182,234 5,019,522 5,262,336 6,503,786 5,256,583 4,748,103 5,283,202 5,231,474 5,434,095 5,528,058 and foreign patents. U.S. and Foreign patents pending. All Rights Reserved.



Стандарт Электрон Связь

Мы молодая и активно развивающаяся компания в области поставок электронных компонентов. Мы поставляем электронные компоненты отечественного и импортного производства напрямую от производителей и с крупнейших складов мира.

Благодаря сотрудничеству с мировыми поставщиками мы осуществляем комплексные и плановые поставки широчайшего спектра электронных компонентов.

Собственная эффективная логистика и склад в обеспечивает надежную поставку продукции в точно указанные сроки по всей России.

Мы осуществляем техническую поддержку нашим клиентам и предпродажную проверку качества продукции. На все поставляемые продукты мы предоставляем гарантию .

Осуществляем поставки продукции под контролем ВП МО РФ на предприятия военно-промышленного комплекса России , а также работаем в рамках 275 ФЗ с открытием отдельных счетов в уполномоченном банке. Система менеджмента качества компании соответствует требованиям ГОСТ ISO 9001.

Минимальные сроки поставки, гибкие цены, неограниченный ассортимент и индивидуальный подход к клиентам являются основой для выстраивания долгосрочного и эффективного сотрудничества с предприятиями радиоэлектронной промышленности, предприятиями ВПК и научно-исследовательскими институтами России.

С нами вы становитесь еще успешнее!

Наши контакты:

Телефон: +7 812 627 14 35

Электронная почта: sales@st-electron.ru

Адрес: 198099, Санкт-Петербург,
Промышленная ул, дом № 19, литера Н,
помещение 100-Н Офис 331