

SN54ACT574, SN74ACT574 OCTAL D-TYPE EDGE-TRIGGERED FLIP-FLOPS WITH 3-STATE OUTPUTS

SCAS537D – OCTOBER 1995 – REVISED NOVEMBER 2002

- 4.5-V to 5.5-V V_{CC} Operation
- Inputs Accept Voltages to 5.5 V
- Max t_{pd} of 9 ns at 5 V
- Inputs Are TTL-Voltage Compatible

description/ordering information

These 8-bit flip-flops feature 3-state outputs designed specifically for driving highly capacitive or relatively low-impedance loads. The devices are particularly suitable for implementing buffer registers, I/O ports, bidirectional bus drivers, and working registers.

The eight flip-flops of the 'ACT574 devices are D-type edge-triggered flip-flops. On the positive transition of the clock (CLK) input, the Q outputs are set to the logic levels set up at the data (D) inputs.

A buffered output-enable (\overline{OE}) input can be used to place the eight outputs in either a normal logic state (high or low logic levels) or the high-impedance state. In the high-impedance state, the outputs neither load nor drive the bus lines significantly. The high-impedance state and the increased drive provide the capability to drive bus lines in a bus-organized system without need for interface or pullup components.

\overline{OE} does not affect internal operations of the flip-flop. Old data can be retained or new data can be entered while the outputs are in the high-impedance state.

To ensure the high-impedance state during power up or power down, \overline{OE} should be tied to V_{CC} through a pullup resistor; the minimum value of the resistor is determined by the current-sinking capability of the driver.

SN54ACT574 . . . J OR W PACKAGE SN74ACT574 . . . DB, DW, N, NS, OR PW PACKAGE (TOP VIEW)

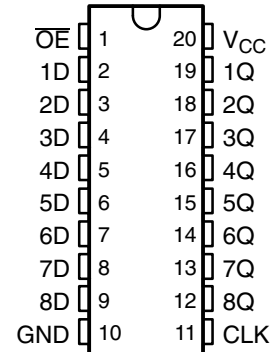

SN54ACT574 . . . FK PACKAGE (TOP VIEW)

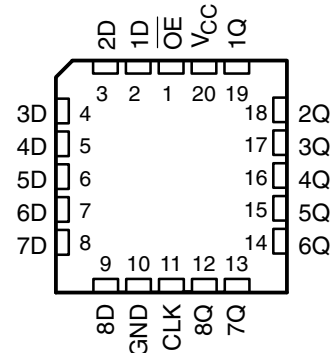

ORDERING INFORMATION

| T_A | PACKAGE† | | ORDERABLE PART NUMBER | TOP-SIDE MARKING |
|----------------|---------------|---------------|-----------------------|------------------|
| -40°C to 85°C | PDIP – N | Tube | SN74ACT574N | SN74ACT574N |
| | SOIC – DW | Tube | SN74ACT574DW | ACT574 |
| | | Tape and reel | SN74ACT574DWR | |
| | SOP – NS | Tape and reel | SN74ACT574NSR | ACT574 |
| | SSOP – DB | Tape and reel | SN74ACT574DBR | AD574 |
| TSSOP – PW | Tape and reel | SN74ACT574PWR | AD574 | |
| -55°C to 125°C | CDIP – J | Tube | SNJ54ACT574J | SNJ54ACT574J |
| | CFP – W | Tube | SNJ54ACT574W | SNJ54ACT574W |
| | LCCC – FK | Tube | SNJ54ACT574FK | SNJ54ACT574FK |

† Package drawings, standard packing quantities, thermal data, symbolization, and PCB design guidelines are available at www.ti.com/sc/package.



Please be aware that an important notice concerning availability, standard warranty, and use in critical applications of Texas Instruments semiconductor products and disclaimers thereto appears at the end of this data sheet.

UNLESS OTHERWISE NOTED this document contains PRODUCTION DATA information current as of publication date. Products conform to specifications per the terms of Texas Instruments standard warranty. Production processing does not necessarily include testing of all parameters.

 **TEXAS
INSTRUMENTS**

POST OFFICE BOX 655303 • DALLAS, TEXAS 75265

Copyright © 2002, Texas Instruments Incorporated

SN54ACT574, SN74ACT574 OCTAL D-TYPE EDGE-TRIGGERED FLIP-FLOPS WITH 3-STATE OUTPUTS

SCAS537D – OCTOBER 1995 – REVISED NOVEMBER 2002

FUNCTION TABLE
(each flip-flop)

| INPUTS | | | OUTPUT |
|--------|--------|---|----------------|
| OE | CLK | D | Q |
| L | ↑ | H | H |
| L | ↑ | L | L |
| L | H or L | X | Q ₀ |
| H | X | X | Z |

logic diagram (positive logic)

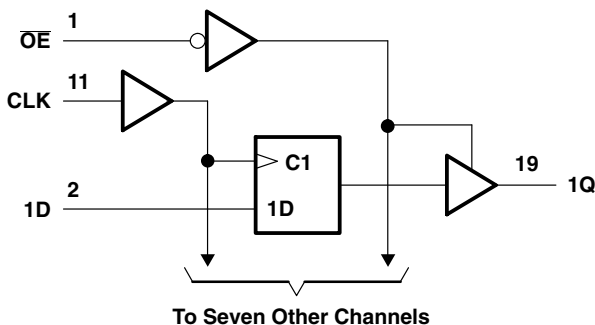

absolute maximum ratings over operating free-air temperature range (unless otherwise noted)[†]

| | |
|----------------------------------------------------------------|----------------------------|
| Supply voltage range, V_{CC} | -0.5 V to 7 V |
| Input voltage range, V_I (see Note 1) | -0.5 V to $V_{CC} + 0.5$ V |
| Output voltage range, V_O (see Note 1) | -0.5 V to $V_{CC} + 0.5$ V |
| Input clamp current, I_{IK} ($V_I < 0$ or $V_I > V_{CC}$) | ±20 mA |
| Output clamp current, I_{OK} ($V_O < 0$ or $V_O > V_{CC}$) | ±20 mA |
| Continuous output current, I_O ($V_O = 0$ to V_{CC}) | ±50 mA |
| Continuous current through V_{CC} or GND | ±200 mA |
| Package thermal impedance, θ_{JA} (see Note 2): | |
| DB package | 70°C/W |
| DW package | 58°C/W |
| N package | 69°C/W |
| NS package | 60°C/W |
| PW package | 83°C/W |
| Storage temperature range, T_{stg} | -65°C to 150°C |

[†] Stresses beyond those listed under “absolute maximum ratings” may cause permanent damage to the device. These are stress ratings only, and functional operation of the device at these or any other conditions beyond those indicated under “recommended operating conditions” is not implied. Exposure to absolute-maximum-rated conditions for extended periods may affect device reliability.

- NOTES: 1. The input and output voltage ratings may be exceeded if the input and output current ratings are observed.
2. The package thermal impedance is calculated in accordance with JESD 51-7.

SN54ACT574, SN74ACT574 OCTAL D-TYPE EDGE-TRIGGERED FLIP-FLOPS WITH 3-STATE OUTPUTS

SCAS537D – OCTOBER 1995 – REVISED NOVEMBER 2002

recommended operating conditions (see Note 3)

| | | SN54ACT574 | | SN74ACT574 | | UNIT |
|---------------------|------------------------------------|------------|----------|------------|----------|------|
| | | MIN | MAX | MIN | MAX | |
| V_{CC} | Supply voltage | 4.5 | 5.5 | 4.5 | 5.5 | V |
| V_{IH} | High-level input voltage | 2 | | 2 | | V |
| V_{IL} | Low-level input voltage | | 0.8 | | 0.8 | V |
| V_I | Input voltage | 0 | V_{CC} | 0 | V_{CC} | V |
| V_O | Output voltage | 0 | V_{CC} | 0 | V_{CC} | V |
| I_{OH} | High-level output current | | -24 | | -24 | mA |
| I_{OL} | Low-level output current | | 24 | | 24 | mA |
| $\Delta t/\Delta v$ | Input transition rise or fall rate | | 8 | | 8 | ns/V |
| T_A | Operating free-air temperature | -55 | 125 | -40 | 85 | °C |

NOTE 3: All unused inputs of the device must be held at V_{CC} or GND to ensure proper device operation. Refer to the TI application report *Implications of Slow or Floating CMOS Inputs*, literature number SCBA004.

electrical characteristics over recommended operating free-air temperature range (unless otherwise noted)

| PARAMETER | TEST CONDITIONS | V_{CC} | $T_A = 25^\circ\text{C}$ | | | SN54ACT574 | | SN74ACT574 | | UNIT |
|-----------------------------------|-----------------------------------------------------|----------|--------------------------|------|------------|------------|---------|------------|---------------|------|
| | | | MIN | TYP | MAX | MIN | MAX | MIN | MAX | |
| V_{OH} | $I_{OH} = -50 \mu\text{A}$ | 4.5 V | 4.4 | 4.49 | 4.4 | | 4.4 | | V | |
| | | 5.5 V | 5.4 | 5.49 | 5.4 | | 5.4 | | | |
| | $I_{OH} = -24 \text{ mA}$ | 4.5 V | 3.86 | | 3.7 | | 3.76 | | | |
| | | 5.5 V | 4.86 | | 4.7 | | 4.76 | | | |
| | $I_{OH} = -50 \text{ mA}^\dagger$ | 5.5 V | | | 3.85 | | | | | |
| $I_{OH} = -75 \text{ mA}^\dagger$ | 5.5 V | | | | | 3.85 | | | | |
| V_{OL} | $I_{OL} = 50 \mu\text{A}$ | 4.5 V | | | 0.1 | | 0.1 | 0.1 | V | |
| | | 5.5 V | | | 0.1 | | 0.1 | 0.1 | | |
| | $I_{OL} = 24 \text{ mA}$ | 4.5 V | | | 0.36 | | 0.44 | 0.44 | | |
| | | 5.5 V | | | 0.36 | | 0.44 | 0.44 | | |
| | $I_{OL} = 50 \text{ mA}^\dagger$ | 5.5 V | | | | | 1.65 | | | |
| $I_{OL} = 75 \text{ mA}^\dagger$ | 5.5 V | | | | | | 1.65 | | | |
| I_{OZ} | $V_O = V_{CC}$ or GND | 5.5 V | | | ± 0.25 | | ± 5 | ± 2.5 | μA | |
| I_I | $V_I = V_{CC}$ or GND | 5.5 V | | | ± 0.1 | | ± 1 | ± 1 | μA | |
| I_{CC} | $V_I = V_{CC}$ or GND, $I_O = 0$ | 5.5 V | | | 4 | | 80 | 40 | μA | |
| ΔI_{CC}^\ddagger | One input at 3.4 V, Other inputs at GND or V_{CC} | 5.5 V | | 0.6 | | | 1.5 | 1.5 | mA | |
| C_i | $V_I = V_{CC}$ or GND | 5 V | | 4.5 | | | | | pF | |

[†] Not more than one output should be tested at a time, and the duration of the test should not exceed 2 ms.

[‡] This is the increase in supply current for each input that is at one of the specified TTL voltage levels, rather than 0 V or V_{CC} .

PRODUCT PREVIEW information concerns products in the formative or design phase of development. Characteristic data and other specifications are design goals. Texas Instruments reserves the right to change or discontinue these products without notice.



POST OFFICE BOX 655303 • DALLAS, TEXAS 75265

SN54ACT574, SN74ACT574 OCTAL D-TYPE EDGE-TRIGGERED FLIP-FLOPS WITH 3-STATE OUTPUTS

SCAS537D – OCTOBER 1995 – REVISED NOVEMBER 2002

timing requirements over recommended operating free-air temperature range, $V_{CC} = 5\text{ V} \pm 0.5\text{ V}$ (unless otherwise noted) (see Figure 1)

| | | $T_A = 25^\circ\text{C}$ | | SN54ACT574 | | SN74ACT574 | | UNIT |
|--------------------|----------------------------------------|--------------------------|-----|------------|-----|------------|-----|------|
| | | MIN | MAX | MIN | MAX | MIN | MAX | |
| f_{clock} | Clock frequency | 100 | | 70 | | 85 | | MHz |
| t_w | Pulse duration, CLK high or low | 3 | | 5 | | 4 | | ns |
| t_{su} | Setup time, data before CLK \uparrow | 2.5 | | 3.5 | | 2.5 | | ns |
| t_h | Hold time, data after CLK \uparrow | 1 | | 2 | | 1 | | ns |

switching characteristics over recommended operating free-air temperature range, $V_{CC} = 5\text{ V} \pm 0.5\text{ V}$ (unless otherwise noted) (see Figure 1)

| PARAMETER | FROM (INPUT) | TO (OUTPUT) | $T_A = 25^\circ\text{C}$ | | | SN54ACT574 | | SN74ACT574 | | UNIT |
|------------------|------------------------|-------------|--------------------------|-----|------|------------|------|------------|------|------|
| | | | MIN | TYP | MAX | MIN | MAX | MIN | MAX | |
| f_{max} | | | 100 | 110 | | 70 | | 85 | | MHz |
| t_{PLH} | CLK | Q | 2.5 | 7 | 11 | 1.5 | 13.5 | 2 | 12 | ns |
| t_{PHL} | | | 2 | 6.5 | 10 | 1.5 | 12.5 | 1.5 | 11 | |
| t_{PZH} | $\overline{\text{OE}}$ | Q | 2 | 6.4 | 9.5 | 1.5 | 11 | 1.5 | 10 | ns |
| t_{PZL} | | | 2 | 6 | 9 | 1.5 | 11 | 1.5 | 10 | |
| t_{PHZ} | $\overline{\text{OE}}$ | Q | 2 | 7 | 10.5 | 1.5 | 12 | 1.5 | 11.5 | ns |
| t_{PLZ} | | | 2 | 5.5 | 8.5 | 1.5 | 10 | 1.5 | 9 | |

operating characteristics, $V_{CC} = 5\text{ V}$, $T_A = 25^\circ\text{C}$

| PARAMETER | TEST CONDITIONS | TYP | UNIT |
|-----------------------------------------------|-------------------------------------------|-----|------|
| C_{pd} Power dissipation capacitance | $C_L = 50\text{ pF}$, $f = 1\text{ MHz}$ | 40 | pF |

PRODUCT PREVIEW information concerns products in the formative or design phase of development. Characteristic data and other specifications are design goals. Texas Instruments reserves the right to change or discontinue these products without notice.



POST OFFICE BOX 655303 • DALLAS, TEXAS 75265

SN54ACT574, SN74ACT574 OCTAL D-TYPE EDGE-TRIGGERED FLIP-FLOPS WITH 3-STATE OUTPUTS

SCAS537D – OCTOBER 1995 – REVISED NOVEMBER 2002

PARAMETER MEASUREMENT INFORMATION

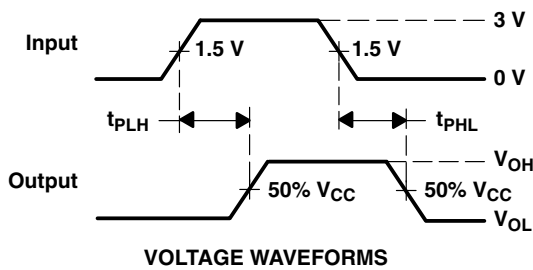
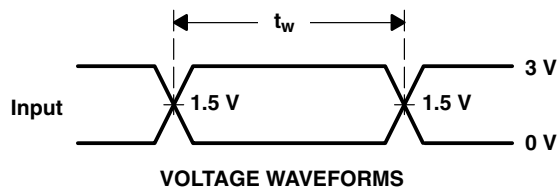
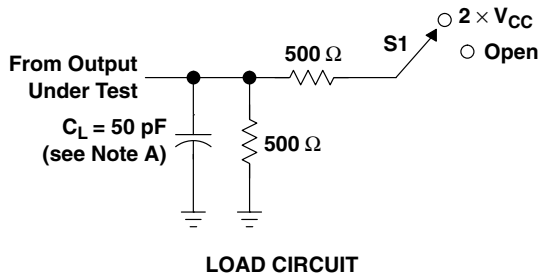

| TEST | S1 |
|-------------------|-------------------|
| t_{PLH}/t_{PHL} | Open |
| t_{PLZ}/t_{PZL} | $2 \times V_{CC}$ |
| t_{PHZ}/t_{PZH} | Open |

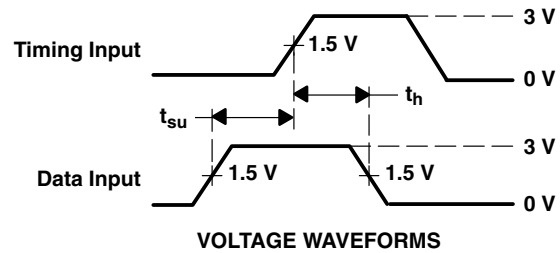

- NOTES: A. C_L includes probe and jig capacitance.
 B. Waveform 1 is for an output with internal conditions such that the output is low except when disabled by the output control. Waveform 2 is for an output with internal conditions such that the output is high except when disabled by the output control.
 C. All input pulses are supplied by generators having the following characteristics: $PRR \leq 1 \text{ MHz}$, $Z_O = 50 \Omega$, $t_r \leq 2.5 \text{ ns}$, $t_f \leq 2.5 \text{ ns}$.
 D. The outputs are measured one at a time with one input transition per measurement.

Figure 1. Load Circuit and Voltage Waveforms

PACKAGING INFORMATION

| Orderable Device | Status (1) | Package Type | Package Drawing | Pins | Package Qty | Eco Plan (2) | Lead/Ball Finish | MSL Peak Temp (3) | Op Temp (°C) | Top-Side Markings (4) | Samples |
|------------------|---------------|--------------|-----------------|------|-------------|-------------------------|------------------|----------------------|--------------|--------------------------|-------------------------|
| SN74ACT574DBLE | OBSOLETE | SSOP | DB | 20 | | TBD | Call TI | Call TI | -40 to 85 | | |
| SN74ACT574DBR | ACTIVE | SSOP | DB | 20 | 2000 | Green (RoHS & no Sb/Br) | CU NIPDAU | Level-1-260C-UNLIM | -40 to 85 | AD574 | Samples |
| SN74ACT574DBRE4 | ACTIVE | SSOP | DB | 20 | 2000 | Green (RoHS & no Sb/Br) | CU NIPDAU | Level-1-260C-UNLIM | -40 to 85 | AD574 | Samples |
| SN74ACT574DBRG4 | ACTIVE | SSOP | DB | 20 | 2000 | Green (RoHS & no Sb/Br) | CU NIPDAU | Level-1-260C-UNLIM | -40 to 85 | AD574 | Samples |
| SN74ACT574DW | ACTIVE | SOIC | DW | 20 | 25 | Green (RoHS & no Sb/Br) | CU NIPDAU | Level-1-260C-UNLIM | -40 to 85 | ACT574 | Samples |
| SN74ACT574DWE4 | ACTIVE | SOIC | DW | 20 | 25 | Green (RoHS & no Sb/Br) | CU NIPDAU | Level-1-260C-UNLIM | -40 to 85 | ACT574 | Samples |
| SN74ACT574DWG4 | ACTIVE | SOIC | DW | 20 | 25 | Green (RoHS & no Sb/Br) | CU NIPDAU | Level-1-260C-UNLIM | -40 to 85 | ACT574 | Samples |
| SN74ACT574DWR | ACTIVE | SOIC | DW | 20 | 2000 | Green (RoHS & no Sb/Br) | CU NIPDAU | Level-1-260C-UNLIM | -40 to 85 | ACT574 | Samples |
| SN74ACT574DWRE4 | ACTIVE | SOIC | DW | 20 | 2000 | Green (RoHS & no Sb/Br) | CU NIPDAU | Level-1-260C-UNLIM | -40 to 85 | ACT574 | Samples |
| SN74ACT574DWRG4 | ACTIVE | SOIC | DW | 20 | 2000 | Green (RoHS & no Sb/Br) | CU NIPDAU | Level-1-260C-UNLIM | -40 to 85 | ACT574 | Samples |
| SN74ACT574N | ACTIVE | PDIP | N | 20 | 20 | Pb-Free (RoHS) | CU NIPDAU | N / A for Pkg Type | -40 to 85 | SN74ACT574N | Samples |
| SN74ACT574NE4 | ACTIVE | PDIP | N | 20 | 20 | Pb-Free (RoHS) | CU NIPDAU | N / A for Pkg Type | -40 to 85 | SN74ACT574N | Samples |
| SN74ACT574NSR | ACTIVE | SO | NS | 20 | 2000 | Green (RoHS & no Sb/Br) | CU NIPDAU | Level-1-260C-UNLIM | -40 to 85 | ACT574 | Samples |
| SN74ACT574NSRE4 | ACTIVE | SO | NS | 20 | 2000 | Green (RoHS & no Sb/Br) | CU NIPDAU | Level-1-260C-UNLIM | -40 to 85 | ACT574 | Samples |
| SN74ACT574NSRG4 | ACTIVE | SO | NS | 20 | 2000 | Green (RoHS & no Sb/Br) | CU NIPDAU | Level-1-260C-UNLIM | -40 to 85 | ACT574 | Samples |
| SN74ACT574PW | ACTIVE | TSSOP | PW | 20 | 70 | Green (RoHS & no Sb/Br) | CU NIPDAU | Level-1-260C-UNLIM | -40 to 85 | AD574 | Samples |
| SN74ACT574PWE4 | ACTIVE | TSSOP | PW | 20 | 70 | Green (RoHS & no Sb/Br) | CU NIPDAU | Level-1-260C-UNLIM | -40 to 85 | AD574 | Samples |

| Orderable Device | Status (1) | Package Type | Package Drawing | Pins | Package Qty | Eco Plan (2) | Lead/Ball Finish | MSL Peak Temp (3) | Op Temp (°C) | Top-Side Markings (4) | Samples |
|------------------|---------------|--------------|--------------------|------|-------------|----------------------------|------------------|----------------------|--------------|--------------------------|-------------------------|
| SN74ACT574PWG4 | ACTIVE | TSSOP | PW | 20 | 70 | Green (RoHS & no Sb/Br) | CU NIPDAU | Level-1-260C-UNLIM | -40 to 85 | AD574 | Samples |
| SN74ACT574PWLE | OBSOLETE | TSSOP | PW | 20 | | TBD | Call TI | Call TI | -40 to 85 | | |
| SN74ACT574PWR | ACTIVE | TSSOP | PW | 20 | 2000 | Green (RoHS & no Sb/Br) | CU NIPDAU | Level-1-260C-UNLIM | -40 to 85 | AD574 | Samples |
| SN74ACT574PWRE4 | ACTIVE | TSSOP | PW | 20 | 2000 | Green (RoHS & no Sb/Br) | CU NIPDAU | Level-1-260C-UNLIM | -40 to 85 | AD574 | Samples |
| SN74ACT574PWRG4 | ACTIVE | TSSOP | PW | 20 | 2000 | Green (RoHS & no Sb/Br) | CU NIPDAU | Level-1-260C-UNLIM | -40 to 85 | AD574 | Samples |

(1) The marketing status values are defined as follows:

ACTIVE: Product device recommended for new designs.

LIFEBUY: TI has announced that the device will be discontinued, and a lifetime-buy period is in effect.

NRND: Not recommended for new designs. Device is in production to support existing customers, but TI does not recommend using this part in a new design.

PREVIEW: Device has been announced but is not in production. Samples may or may not be available.

OBSOLETE: TI has discontinued the production of the device.

(2) Eco Plan - The planned eco-friendly classification: Pb-Free (RoHS), Pb-Free (RoHS Exempt), or Green (RoHS & no Sb/Br) - please check <http://www.ti.com/productcontent> for the latest availability information and additional product content details.

TBD: The Pb-Free/Green conversion plan has not been defined.

Pb-Free (RoHS): TI's terms "Lead-Free" or "Pb-Free" mean semiconductor products that are compatible with the current RoHS requirements for all 6 substances, including the requirement that lead not exceed 0.1% by weight in homogeneous materials. Where designed to be soldered at high temperatures, TI Pb-Free products are suitable for use in specified lead-free processes.

Pb-Free (RoHS Exempt): This component has a RoHS exemption for either 1) lead-based flip-chip solder bumps used between the die and package, or 2) lead-based die adhesive used between the die and leadframe. The component is otherwise considered Pb-Free (RoHS compatible) as defined above.

Green (RoHS & no Sb/Br): TI defines "Green" to mean Pb-Free (RoHS compatible), and free of Bromine (Br) and Antimony (Sb) based flame retardants (Br or Sb do not exceed 0.1% by weight in homogeneous material)

(3) MSL, Peak Temp. -- The Moisture Sensitivity Level rating according to the JEDEC industry standard classifications, and peak solder temperature.

(4) Only one of markings shown within the brackets will appear on the physical device.

Important Information and Disclaimer: The information provided on this page represents TI's knowledge and belief as of the date that it is provided. TI bases its knowledge and belief on information provided by third parties, and makes no representation or warranty as to the accuracy of such information. Efforts are underway to better integrate information from third parties. TI has taken and continues to take reasonable steps to provide representative and accurate information but may not have conducted destructive testing or chemical analysis on incoming materials and chemicals. TI and TI suppliers consider certain information to be proprietary, and thus CAS numbers and other limited information may not be available for release.

In no event shall TI's liability arising out of such information exceed the total purchase price of the TI part(s) at issue in this document sold by TI to Customer on an annual basis.

TAPE AND REEL INFORMATION

QUADRANT ASSIGNMENTS FOR PIN 1 ORIENTATION IN TAPE

*All dimensions are nominal

| Device | Package Type | Package Drawing | Pins | SPQ | Reel Diameter (mm) | Reel Width W1 (mm) | A0 (mm) | B0 (mm) | K0 (mm) | P1 (mm) | W (mm) | Pin1 Quadrant |
|---------------|--------------|-----------------|------|------|--------------------|--------------------|---------|---------|---------|---------|--------|---------------|
| SN74ACT574DBR | SSOP | DB | 20 | 2000 | 330.0 | 16.4 | 8.2 | 7.5 | 2.5 | 12.0 | 16.0 | Q1 |
| SN74ACT574DWR | SOIC | DW | 20 | 2000 | 330.0 | 24.4 | 10.8 | 13.0 | 2.7 | 12.0 | 24.0 | Q1 |
| SN74ACT574NSR | SO | NS | 20 | 2000 | 330.0 | 24.4 | 8.2 | 13.0 | 2.5 | 12.0 | 24.0 | Q1 |
| SN74ACT574PWR | TSSOP | PW | 20 | 2000 | 330.0 | 16.4 | 6.95 | 7.1 | 1.6 | 8.0 | 16.0 | Q1 |

TAPE AND REEL BOX DIMENSIONS



*All dimensions are nominal

| Device | Package Type | Package Drawing | Pins | SPQ | Length (mm) | Width (mm) | Height (mm) |
|---------------|--------------|-----------------|------|------|-------------|------------|-------------|
| SN74ACT574DBR | SSOP | DB | 20 | 2000 | 367.0 | 367.0 | 38.0 |
| SN74ACT574DWR | SOIC | DW | 20 | 2000 | 367.0 | 367.0 | 45.0 |
| SN74ACT574NSR | SO | NS | 20 | 2000 | 367.0 | 367.0 | 45.0 |
| SN74ACT574PWR | TSSOP | PW | 20 | 2000 | 367.0 | 367.0 | 38.0 |

N (R-PDIP-T**)

PLASTIC DUAL-IN-LINE PACKAGE

16 PINS SHOWN



- NOTES:
- A. All linear dimensions are in inches (millimeters).
 - B. This drawing is subject to change without notice.
 - Falls within JEDEC MS-001, except 18 and 20 pin minimum body length (Dim A).
 - The 20 pin end lead shoulder width is a vendor option, either half or full width.

DW (R-PDSO-G20)

PLASTIC SMALL OUTLINE



- NOTES:
- A. All linear dimensions are in inches (millimeters). Dimensioning and tolerancing per ASME Y14.5M-1994.
 - B. This drawing is subject to change without notice.
 - C. Body dimensions do not include mold flash or protrusion not to exceed 0.006 (0,15).
 - D. Falls within JEDEC MS-013 variation AC.

PW (R-PDSO-G20)

PLASTIC SMALL OUTLINE



- NOTES:
- A. All linear dimensions are in millimeters.
 - B. This drawing is subject to change without notice.
 - C. Publication IPC-7351 is recommended for alternate design.
 - D. Laser cutting apertures with trapezoidal walls and also rounding corners will offer better paste release. Customers should contact their board assembly site for stencil design recommendations. Refer to IPC-7525 for other stencil recommendations.
 - E. Customers should contact their board fabrication site for solder mask tolerances between and around signal pads.

MECHANICAL DATA

NS (R-PDSO-G**)

PLASTIC SMALL-OUTLINE PACKAGE

14-PINS SHOWN



- NOTES:
- A. All linear dimensions are in millimeters.
 - B. This drawing is subject to change without notice.
 - C. Body dimensions do not include mold flash or protrusion, not to exceed 0,15.

DB (R-PDSO-G**)

PLASTIC SMALL-OUTLINE

28 PINS SHOWN



- NOTES: A. All linear dimensions are in millimeters.
 B. This drawing is subject to change without notice.
 C. Body dimensions do not include mold flash or protrusion not to exceed 0,15.
 D. Falls within JEDEC MO-150

IMPORTANT NOTICE

Texas Instruments Incorporated and its subsidiaries (TI) reserve the right to make corrections, enhancements, improvements and other changes to its semiconductor products and services per JESD46, latest issue, and to discontinue any product or service per JESD48, latest issue. Buyers should obtain the latest relevant information before placing orders and should verify that such information is current and complete. All semiconductor products (also referred to herein as "components") are sold subject to TI's terms and conditions of sale supplied at the time of order acknowledgment.

TI warrants performance of its components to the specifications applicable at the time of sale, in accordance with the warranty in TI's terms and conditions of sale of semiconductor products. Testing and other quality control techniques are used to the extent TI deems necessary to support this warranty. Except where mandated by applicable law, testing of all parameters of each component is not necessarily performed.

TI assumes no liability for applications assistance or the design of Buyers' products. Buyers are responsible for their products and applications using TI components. To minimize the risks associated with Buyers' products and applications, Buyers should provide adequate design and operating safeguards.

TI does not warrant or represent that any license, either express or implied, is granted under any patent right, copyright, mask work right, or other intellectual property right relating to any combination, machine, or process in which TI components or services are used. Information published by TI regarding third-party products or services does not constitute a license to use such products or services or a warranty or endorsement thereof. Use of such information may require a license from a third party under the patents or other intellectual property of the third party, or a license from TI under the patents or other intellectual property of TI.

Reproduction of significant portions of TI information in TI data books or data sheets is permissible only if reproduction is without alteration and is accompanied by all associated warranties, conditions, limitations, and notices. TI is not responsible or liable for such altered documentation. Information of third parties may be subject to additional restrictions.

Resale of TI components or services with statements different from or beyond the parameters stated by TI for that component or service voids all express and any implied warranties for the associated TI component or service and is an unfair and deceptive business practice. TI is not responsible or liable for any such statements.

Buyer acknowledges and agrees that it is solely responsible for compliance with all legal, regulatory and safety-related requirements concerning its products, and any use of TI components in its applications, notwithstanding any applications-related information or support that may be provided by TI. Buyer represents and agrees that it has all the necessary expertise to create and implement safeguards which anticipate dangerous consequences of failures, monitor failures and their consequences, lessen the likelihood of failures that might cause harm and take appropriate remedial actions. Buyer will fully indemnify TI and its representatives against any damages arising out of the use of any TI components in safety-critical applications.

In some cases, TI components may be promoted specifically to facilitate safety-related applications. With such components, TI's goal is to help enable customers to design and create their own end-product solutions that meet applicable functional safety standards and requirements. Nonetheless, such components are subject to these terms.

No TI components are authorized for use in FDA Class III (or similar life-critical medical equipment) unless authorized officers of the parties have executed a special agreement specifically governing such use.

Only those TI components which TI has specifically designated as military grade or "enhanced plastic" are designed and intended for use in military/aerospace applications or environments. Buyer acknowledges and agrees that any military or aerospace use of TI components which have **not** been so designated is solely at the Buyer's risk, and that Buyer is solely responsible for compliance with all legal and regulatory requirements in connection with such use.

TI has specifically designated certain components as meeting ISO/TS16949 requirements, mainly for automotive use. In any case of use of non-designated products, TI will not be responsible for any failure to meet ISO/TS16949.

Products

| | |
|------------------------------|--------------------------------------------------------------------------------------|
| Audio | www.ti.com/audio |
| Amplifiers | amplifier.ti.com |
| Data Converters | dataconverter.ti.com |
| DLP® Products | www.dlp.com |
| DSP | dsp.ti.com |
| Clocks and Timers | www.ti.com/clocks |
| Interface | interface.ti.com |
| Logic | logic.ti.com |
| Power Mgmt | power.ti.com |
| Microcontrollers | microcontroller.ti.com |
| RFID | www.ti-rfid.com |
| OMAP Applications Processors | www.ti.com/omap |
| Wireless Connectivity | www.ti.com/wirelessconnectivity |

Applications

| | |
|-------------------------------|------------------------------------------------------------------------------------------|
| Automotive and Transportation | www.ti.com/automotive |
| Communications and Telecom | www.ti.com/communications |
| Computers and Peripherals | www.ti.com/computers |
| Consumer Electronics | www.ti.com/consumer-apps |
| Energy and Lighting | www.ti.com/energy |
| Industrial | www.ti.com/industrial |
| Medical | www.ti.com/medical |
| Security | www.ti.com/security |
| Space, Avionics and Defense | www.ti.com/space-avionics-defense |
| Video and Imaging | www.ti.com/video |

TI E2E Community

e2e.ti.com



Стандарт Электрон Связь

Мы молодая и активно развивающаяся компания в области поставок электронных компонентов. Мы поставляем электронные компоненты отечественного и импортного производства напрямую от производителей и с крупнейших складов мира.

Благодаря сотрудничеству с мировыми поставщиками мы осуществляем комплексные и плановые поставки широчайшего спектра электронных компонентов.

Собственная эффективная логистика и склад в обеспечивает надежную поставку продукции в точно указанные сроки по всей России.

Мы осуществляем техническую поддержку нашим клиентам и предпродажную проверку качества продукции. На все поставляемые продукты мы предоставляем гарантию .

Осуществляем поставки продукции под контролем ВП МО РФ на предприятия военно-промышленного комплекса России , а также работаем в рамках 275 ФЗ с открытием отдельных счетов в уполномоченном банке. Система менеджмента качества компании соответствует требованиям ГОСТ ISO 9001.

Минимальные сроки поставки, гибкие цены, неограниченный ассортимент и индивидуальный подход к клиентам являются основой для выстраивания долгосрочного и эффективного сотрудничества с предприятиями радиоэлектронной промышленности, предприятиями ВПК и научно-исследовательскими институтами России.

С нами вы становитесь еще успешнее!

Наши контакты:

Телефон: +7 812 627 14 35

Электронная почта: sales@st-electron.ru

Адрес: 198099, Санкт-Петербург,
Промышленная ул, дом № 19, литера Н,
помещение 100-Н Офис 331