

MMBTH10L, MMBTH10-4L, SMMBTH10-4L, NSVMMBTH10L



ON Semiconductor®

<http://onsemi.com>

VHF/UHF Transistor

NPN Silicon

Features

- S and NSV Prefixes for Automotive and Other Applications Requiring Unique Site and Control Change Requirements; AEC-Q101 Qualified and PPAP Capable
- These Devices are Pb-Free, Halogen Free/BFR Free and are RoHS Compliant*



**SOT-23 (TO-236)
CASE 318
STYLE 6**

MAXIMUM RATINGS

Rating	Symbol	Value	Unit
Collector-Emitter Voltage	V_{CEO}	25	Vdc
Collector-Base Voltage	V_{CBO}	30	Vdc
Emitter-Base Voltage	V_{EBO}	3.0	Vdc

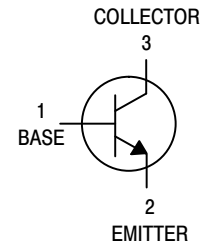

THERMAL CHARACTERISTICS

Characteristic	Symbol	Max	Unit
Total Device Dissipation FR-5 Board (Note 1) $T_A = 25^\circ\text{C}$ Derate above 25°C	P_D	225 1.8	mW mW/°C
Thermal Resistance, Junction to Ambient (Note 1)	$R_{\theta JA}$	556	°C/W
Total Device Dissipation Alumina Substrate (Note 2) $T_A = 25^\circ\text{C}$ Derate above 25°C	P_D	300 2.4	mW mW/°C
Thermal Resistance, Junction to Ambient (Note 2)	$R_{\theta JA}$	417	°C/W
Junction and Storage Temperature Range	T_J, T_{stg}	-55 to +150	°C

MARKING DIAGRAMS

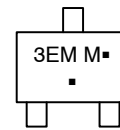

MMBTH10LT1G,
NSVMMBTH10LT1G

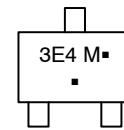

MMBTH10-04LT1G

3EM, 3E4 = Specific Device Code
M = Date Code*
▪ = Pb-Free Package

(Note: Microdot may be in either location)

*Date Code orientation and/or overbar may vary depending upon manufacturing location.

Stresses exceeding Maximum Ratings may damage the device. Maximum Ratings are stress ratings only. Functional operation above the Recommended Operating Conditions is not implied. Extended exposure to stresses above the Recommended Operating Conditions may affect device reliability.

1. FR-5 = $1.0 \times 0.75 \times 0.062$ in.
2. Alumina = $0.4 \times 0.3 \times 0.024$ in. 99.5% alumina

*For additional information on our Pb-Free strategy and soldering details, please download the ON Semiconductor Soldering and Mounting Techniques Reference Manual, SOLDERRM/D.

ORDERING INFORMATION

Device	Package	Shipping†
MMBTH10LT1G	SOT-23 (Pb-Free)	3,000 / Tape & Reel
NSVMMBTH10LT1G	SOT-23 (Pb-Free)	3,000 / Tape & Reel
MMBTH10-4LT1G	SOT-23 (Pb-Free)	3,000 / Tape & Reel
MMBTH10LT3G, SMMBTH10-4LT3G	SOT-23 (Pb-Free)	10,000 / Tape & Reel

†For information on tape and reel specifications, including part orientation and tape sizes, please refer to our Tape and Reel Packaging Specifications Brochure, BRD8011/D.

MMBTH10L, MMBTH10-4L, SMMBTH10-4L, NSVMMBTH10L

ELECTRICAL CHARACTERISTICS ($T_A = 25^\circ\text{C}$ unless otherwise noted)

Characteristic	Symbol	Min	Typ	Max	Unit
----------------	--------	-----	-----	-----	------

OFF CHARACTERISTICS

Collector-Emitter Breakdown Voltage ($I_C = 1.0\text{ mA}$, $I_E = 0$)	$V_{(BR)CEO}$	25	-	-	Vdc
Collector-Base Breakdown Voltage ($I_C = 100\ \mu\text{A}$, $I_E = 0$)	$V_{(BR)CBO}$	30	-	-	Vdc
Emitter-Base Breakdown Voltage ($I_E = 10\ \mu\text{A}$, $I_C = 0$)	$V_{(BR)EBO}$	3.0	-	-	Vdc
Collector Cutoff Current ($V_{CB} = 25\text{ Vdc}$, $I_E = 0$)	I_{CBO}	-	-	100	nAdc
Emitter Cutoff Current ($V_{EB} = 2.0\text{ Vdc}$, $I_C = 0$)	I_{EBO}	-	-	100	nAdc

ON CHARACTERISTICS

DC Current Gain ($I_C = 4.0\text{ mA}$, $V_{CE} = 10\text{ Vdc}$) MMBTH10LT1G, NSVMMBTH10LT1G MMBTH10-4LT1G, SMMBTH10-4LT3G	h_{FE}	60 120	- -	- 240	-
Collector-Emitter Saturation Voltage ($I_C = 4.0\text{ mA}$, $I_E = 0.4\text{ mA}$)	$V_{CE(sat)}$	-	-	0.5	Vdc
Base-Emitter On Voltage ($I_C = 4.0\text{ mA}$, $V_{CE} = 10\text{ Vdc}$)	V_{BE}	-	-	0.95	Vdc

SMALL-SIGNAL CHARACTERISTICS

Current-Gain - Bandwidth Product ($I_C = 4.0\text{ mA}$, $V_{CE} = 10\text{ Vdc}$, $f = 100\text{ MHz}$) MMBTH10LT1G, NSVMMBTH10LT1G MMBTH10-4LT1G, SMMBTH10-4LT3G	f_T	650 800	- -	- -	MHz
Collector-Base Capacitance ($V_{CB} = 10\text{ Vdc}$, $I_E = 0$, $f = 1.0\text{ MHz}$)	C_{cb}	-	-	0.7	pF
Common-Base Feedback Capacitance ($V_{CB} = 10\text{ Vdc}$, $I_E = 0$, $f = 1.0\text{ MHz}$)	C_{rb}	-	-	0.65	pF
Collector Base Time Constant ($I_C = 4.0\text{ mA}$, $V_{CB} = 10\text{ Vdc}$, $f = 31.8\text{ MHz}$)	$r_b'C_c$	-	-	9.0	ps

TYPICAL CHARACTERISTICS

COMMON-BASE y PARAMETERS versus FREQUENCY

($V_{CB} = 10 \text{ Vdc}$, $I_C = 4.0 \text{ mAdc}$, $T_A = 25^\circ\text{C}$)

y_{ib} , INPUT ADMITTANCE

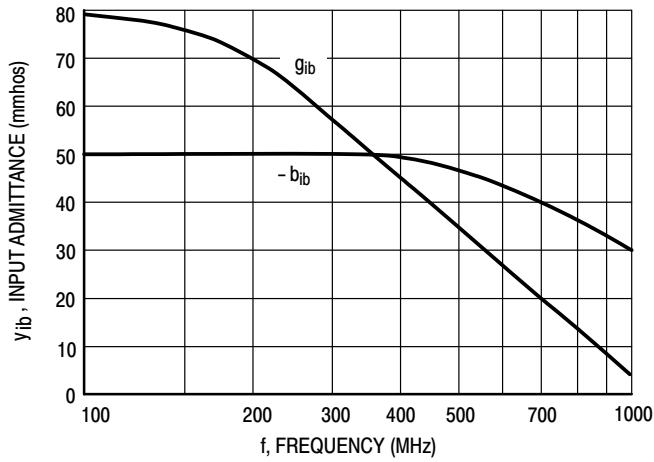

Figure 1. Rectangular Form

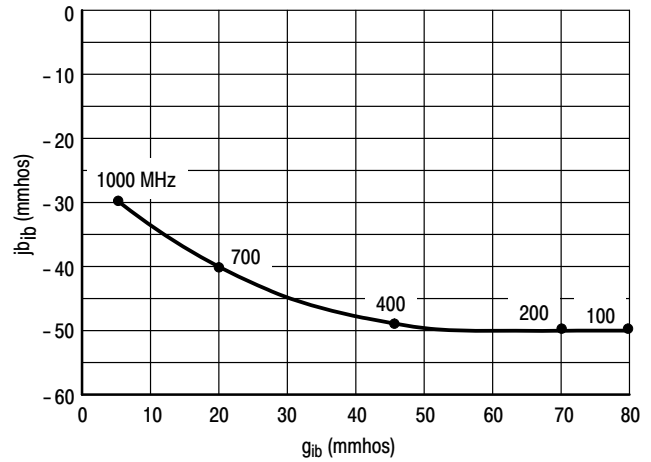

Figure 2. Polar Form

y_{fb} , FORWARD TRANSFER ADMITTANCE

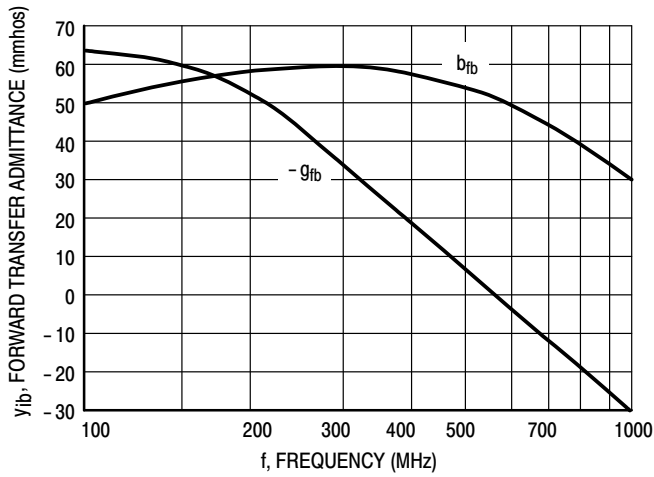

Figure 3. Rectangular Form

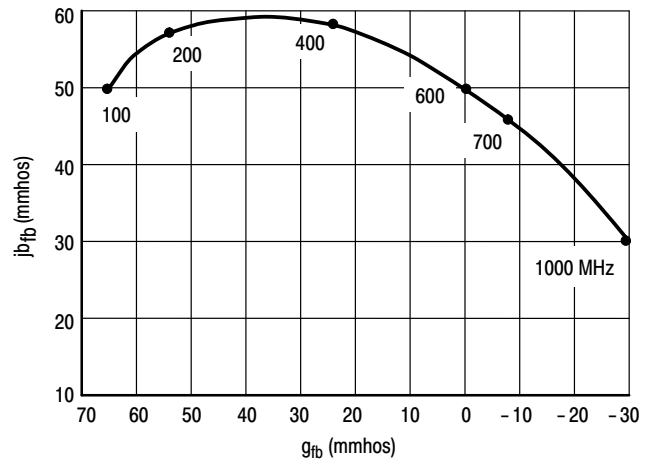

Figure 4. Polar Form

MMBTH10L, MMBTH10-4L, SMMBTH10-4L, NSVMMBTH10L

TYPICAL CHARACTERISTICS

COMMON-BASE y PARAMETERS versus FREQUENCY

($V_{CB} = 10 \text{ Vdc}$, $I_C = 4.0 \text{ mAdc}$, $T_A = 25^\circ\text{C}$)

y_{rb} , REVERSE TRANSFER ADMITTANCE

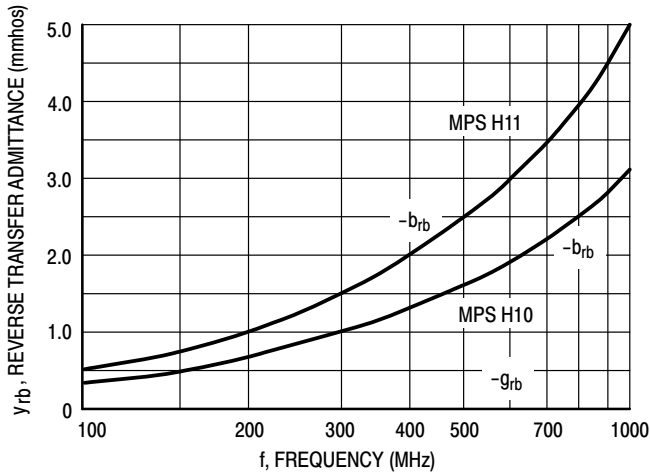

Figure 5. Rectangular Form

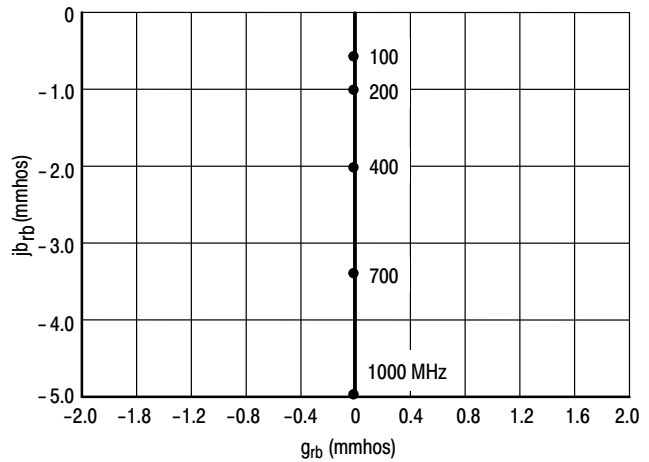

Figure 6. Polar Form

y_{ob} , OUTPUT ADMITTANCE

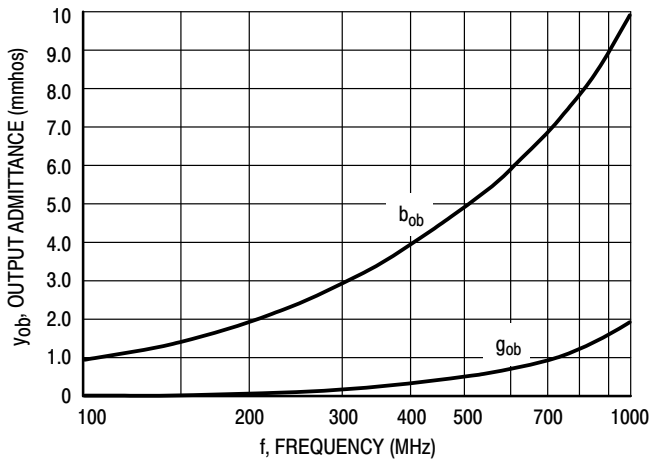

Figure 7. Rectangular Form

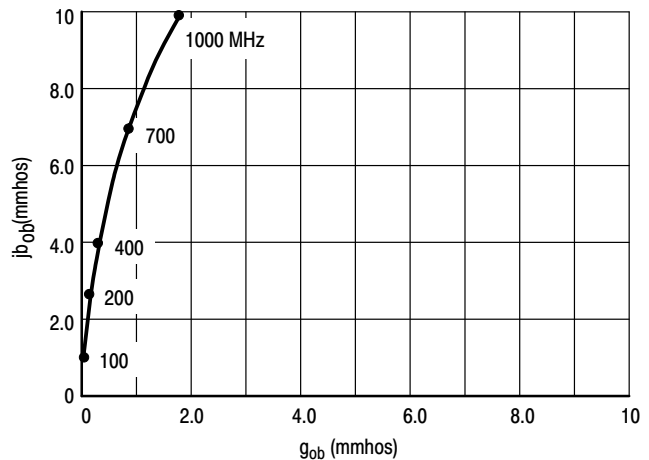
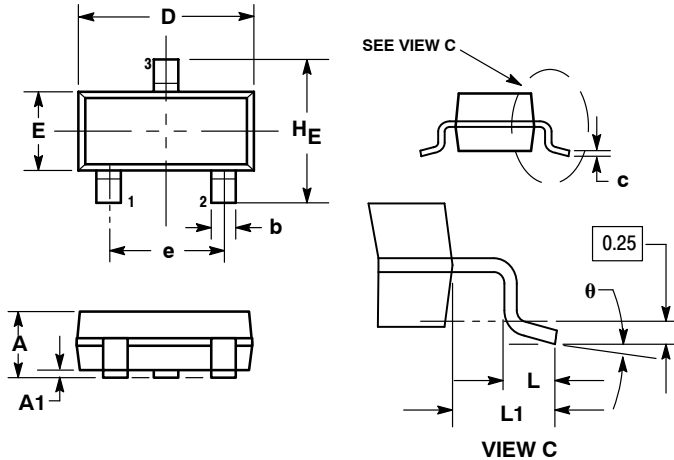

Figure 8. Polar Form

MMBTH10L, MMBTH10-4L, SMMBTH10-4L, NSVMMBTH10L

PACKAGE DIMENSIONS

SOT-23 (TO-236)
CASE 318-08
ISSUE AP



NOTES:

1. DIMENSIONING AND TOLERANCING PER ANSI Y14.5M, 1982.
2. CONTROLLING DIMENSION: INCH.
3. MAXIMUM LEAD THICKNESS INCLUDES LEAD FINISH THICKNESS. MINIMUM LEAD THICKNESS IS THE MINIMUM THICKNESS OF BASE MATERIAL.
4. DIMENSIONS D AND E DO NOT INCLUDE MOLD FLASH, PROTRUSIONS, OR GATE BURRS.

DIM	MILLIMETERS			INCHES		
	MIN	NOM	MAX	MIN	NOM	MAX
A	0.89	1.00	1.11	0.035	0.040	0.044
A1	0.01	0.06	0.10	0.001	0.002	0.004
b	0.37	0.44	0.50	0.015	0.018	0.020
c	0.09	0.13	0.18	0.003	0.005	0.007
D	2.80	2.90	3.04	0.110	0.114	0.120
E	1.20	1.30	1.40	0.047	0.051	0.055
e	1.78	1.90	2.04	0.070	0.075	0.081
L	0.10	0.20	0.30	0.004	0.008	0.012
L1	0.35	0.54	0.69	0.014	0.021	0.029
HE	2.10	2.40	2.64	0.083	0.094	0.104
θ	0°	---	10°	0°	---	10°

STYLE 6:

1. BASE
2. EMITTER
3. COLLECTOR

SOLDERING FOOTPRINT*

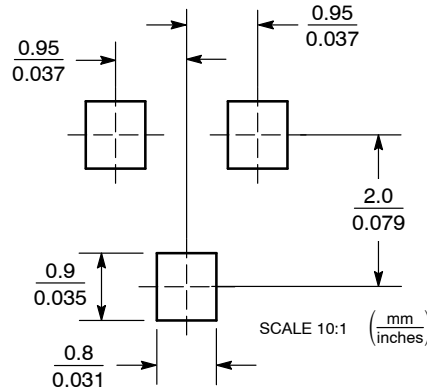

*For additional information on our Pb-Free strategy and soldering details, please download the ON Semiconductor Soldering and Mounting Techniques Reference Manual, SOLDERRM/D.

ON Semiconductor and are registered trademarks of Semiconductor Components Industries, LLC (SCILLC). SCILLC reserves the right to make changes without further notice to any products herein. SCILLC makes no warranty, representation or guarantee regarding the suitability of its products for any particular purpose, nor does SCILLC assume any liability arising out of the application or use of any product or circuit, and specifically disclaims any and all liability, including without limitation special, consequential or incidental damages. "Typical" parameters which may be provided in SCILLC data sheets and/or specifications can and do vary in different applications and actual performance may vary over time. All operating parameters, including "Typicals" must be validated for each customer application by customer's technical experts. SCILLC does not convey any license under its patent rights nor the rights of others. SCILLC products are not designed, intended, or authorized for use as components in systems intended for surgical implant into the body, or other applications intended to support or sustain life, or for any other application in which the failure of the SCILLC product could create a situation where personal injury or death may occur. Should Buyer purchase or use SCILLC products for any such unintended or unauthorized application, Buyer shall indemnify and hold SCILLC and its officers, employees, subsidiaries, affiliates, and distributors harmless against all claims, costs, damages, and expenses, and reasonable attorney fees arising out of, directly or indirectly, any claim of personal injury or death associated with such unintended or unauthorized use, even if such claim alleges that SCILLC was negligent regarding the design or manufacture of the part. SCILLC is an Equal Opportunity/Affirmative Action Employer. This literature is subject to all applicable copyright laws and is not for resale in any manner.

PUBLICATION ORDERING INFORMATION

LITERATURE FULFILLMENT:
Literature Distribution Center for ON Semiconductor
P.O. Box 5163, Denver, Colorado 80217 USA
Phone: 303-675-2175 or 800-344-3860 Toll Free USA/Canada
Fax: 303-675-2176 or 800-344-3867 Toll Free USA/Canada
Email: orderlit@onsemi.com

N. American Technical Support: 800-282-9855 Toll Free
USA/Canada
Europe, Middle East and Africa Technical Support:
Phone: 421 33 790 2910
Japan Customer Focus Center
Phone: 81-3-5817-1050

ON Semiconductor Website: www.onsemi.com
Order Literature: <http://www.onsemi.com/orderlit>

For additional information, please contact your local Sales Representative



Стандарт Электрон Связь

Мы молодая и активно развивающаяся компания в области поставок электронных компонентов. Мы поставляем электронные компоненты отечественного и импортного производства напрямую от производителей и с крупнейших складов мира.

Благодаря сотрудничеству с мировыми поставщиками мы осуществляем комплексные и плановые поставки широчайшего спектра электронных компонентов.

Собственная эффективная логистика и склад в обеспечивает надежную поставку продукции в точно указанные сроки по всей России.

Мы осуществляем техническую поддержку нашим клиентам и предпродажную проверку качества продукции. На все поставляемые продукты мы предоставляем гарантию .

Осуществляем поставки продукции под контролем ВП МО РФ на предприятия военно-промышленного комплекса России , а также работаем в рамках 275 ФЗ с открытием отдельных счетов в уполномоченном банке. Система менеджмента качества компании соответствует требованиям ГОСТ ISO 9001.

Минимальные сроки поставки, гибкие цены, неограниченный ассортимент и индивидуальный подход к клиентам являются основой для выстраивания долгосрочного и эффективного сотрудничества с предприятиями радиоэлектронной промышленности, предприятиями ВПК и научно-исследовательскими институтами России.

С нами вы становитесь еще успешнее!

Наши контакты:

Телефон: +7 812 627 14 35

Электронная почта: sales@st-electron.ru

Адрес: 198099, Санкт-Петербург,
Промышленная ул, дом № 19, литера Н,
помещение 100-Н Офис 331