

PROTECTION PRODUCTS - MicroClamp[®]

Description

The μ Clamp[®] series of Transient Voltage Suppressors (TVS) are designed to replace multilayer varistors (MLVs) in portable applications such as cell phones, notebook computers, and PDAs. They offer superior electrical characteristics such as lower clamping voltage and no device degradation when compared to MLVs. They are designed to protect sensitive semiconductor components from damage or upset due to electrostatic discharge (ESD), lightning, electrical fast transients (EFT), and cable discharge events (CDE).

The μ Clamp[®]2511T is constructed using Semtech's proprietary EPD process technology. The EPD process provides low standoff voltages with significant reductions in leakage currents and capacitance over silicon-avalanche diode processes. They feature a true operating voltage of 2.5 volts for superior protection when compared to traditional pn junction devices.

The μ Clamp2511T is in a 2-pin SLP1006P2T package. It measures 1.0 x 0.6 x 0.4mm. The leads are spaced at a pitch of 0.65mm and are finished with lead-free NiPdAu. Each device will protect one line operating at 2.5 volts. It gives the designer the flexibility to protect single lines in applications where arrays are not practical. They may be used to meet the ESD immunity requirements of IEC 61000-4-2, Level 4 (± 15 kV air, ± 8 kV contact discharge). The combination of small size and high ESD surge capability makes them ideal for use in portable applications such as cellular phones, digital cameras, and MP3 players.

Features

- ◆ Transient protection for data lines to **IEC 61000-4-2 (ESD) ± 15 kV (air), ± 8 kV (contact)**
IEC 61000-4-4 (EFT) 40A (tp = 5/50ns)
Cable Discharge Event (CDE)
- ◆ Ultra-small package (1.0 x 0.6 x 0.4mm)
- ◆ Protects one data line
- ◆ Low reverse current: 10nA typical (VR=2.5V)
- ◆ Working voltage: 2.5V
- ◆ Low leakage current
- ◆ Solid-state silicon-avalanche technology

Mechanical Characteristics

- ◆ SLP1006P2T package
- ◆ Pb-Free, Halogen Free, RoHS/WEEE Compliant
- ◆ Nominal Dimensions: 1.0 x 0.6 x 0.4 mm
- ◆ Lead Finish: NiPdAu
- ◆ Molding compound flammability rating: UL 94V-0
- ◆ Marking : Marking code
- ◆ Packaging : Tape and Reel

Applications

- ◆ Cellular Handsets & Accessories
- ◆ Portable Instrumentation
- ◆ Keypads, Side Keys, LCD Displays
- ◆ Notebooks & Desktop Computers
- ◆ MP3 Players

Dimensions

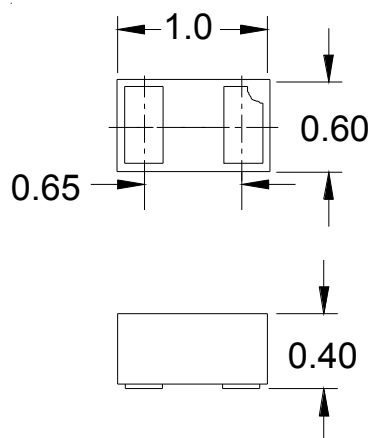

Nominal Dimensions (mm)

Schematic & PIN Configuration

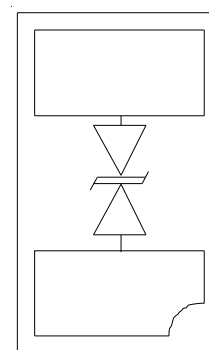

SLP1006P2T (Bottom View)

PROTECTION PRODUCTS
Absolute Maximum Rating

Rating	Symbol	Value	Units
Peak Pulse Power (tp = 8/20μs)	P_{pk}	40	Watts
Maximum Peak Pulse Current (tp = 8/20μs)	I_{pp}	5	Amps
ESD per IEC 61000-4-2 (Air) ESD per IEC 61000-4-2 (Contact)	V_{ESD}	+/- 20 +/- 15	kV
Operating Temperature	T_J	-40 to +85	°C
Storage Temperature	T_{STG}	-55 to +150	°C

Electrical Characteristics (T=25°C)

Parameter	Symbol	Conditions	Minimum	Typical	Maximum	Units
Reverse Stand-Off Voltage	V_{RWM}				2.5	V
Punch-Through Voltage	V_{PT}	$I_{PT} = 2\mu A$	2.7	3.1	3.6	V
Snap-Back Voltage	V_{SB}	$I_{SB} = 50mA$	2.8			V
Reverse Leakage Current	I_R	$V_{RWM} = 2.5V$		0.01	0.05	μA
Clamping Voltage	V_C	$I_{pp} = 1A, tp = 8/20\mu s$			5.5	V
Clamping Voltage	V_C	$I_{pp} = 5A, tp = 8/20\mu s$			8	V
Junction Capacitance	C_J	I/O pin to Gnd $V_R = 0V, f = 1MHz$		6	10	pF

PROTECTION PRODUCTS

Non-Repetitive Peak Pulse Power vs. Pulse Time

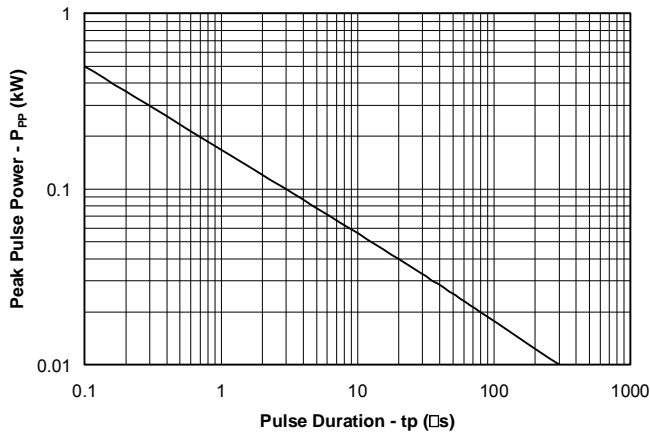

Clamping Voltage vs. Peak Pulse Current

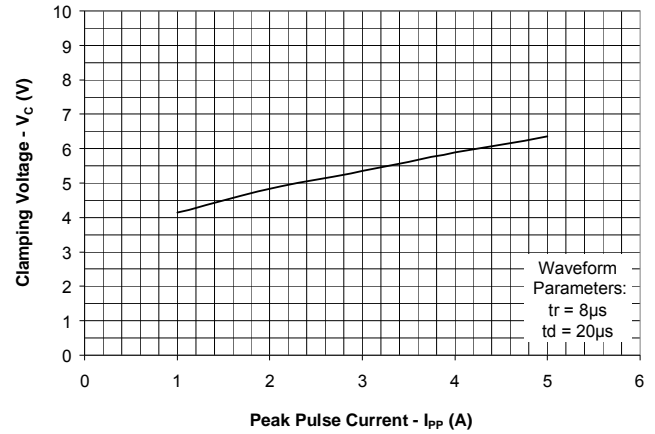

Normalized Junction Capacitance vs. Reverse Voltage

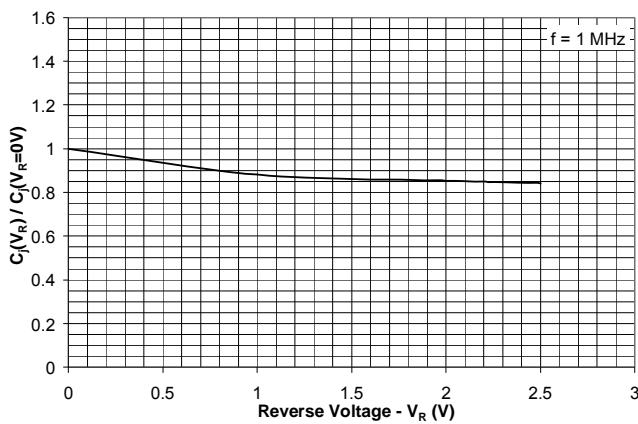

Typical Insertion Loss (S21)

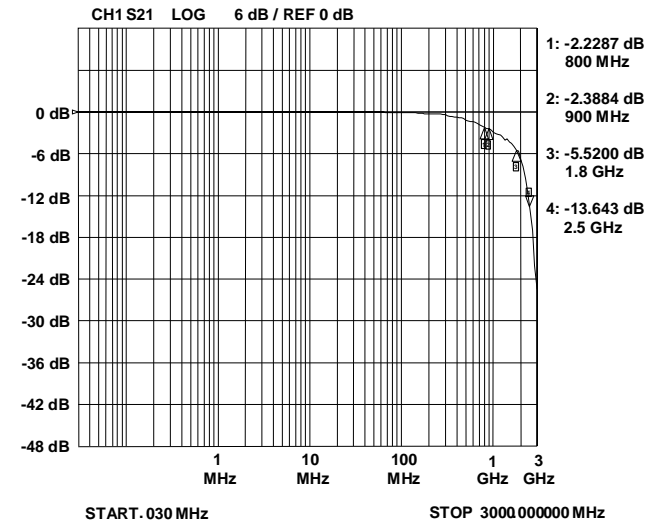

ESD Clamping (Pin 1 to 2 and 2 to 1) (8kV Contact per IEC 61000-4-2)

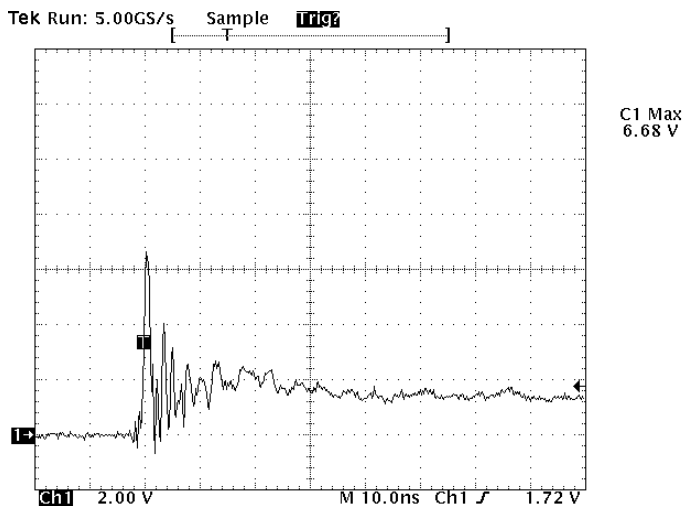

ESD Clamping (Pin 1 to 2 and 2 to 1) (-8kV Contact per IEC 61000-4-2)

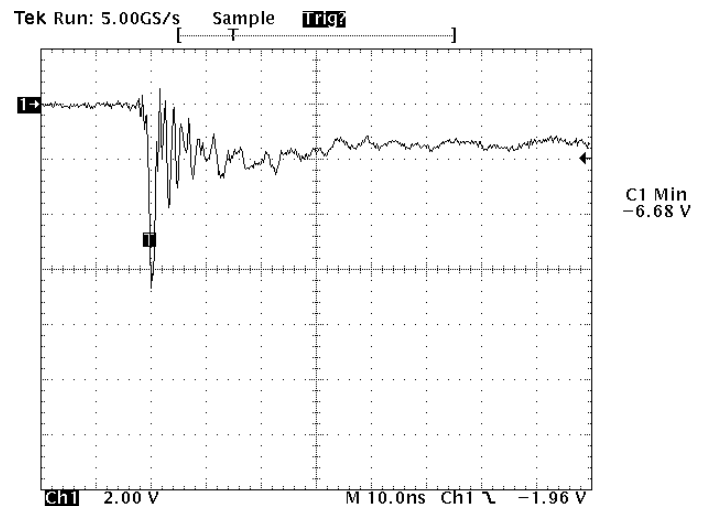

Note: Data is taken with a 10x attenuator

Note: Data is taken with a 10x attenuator

PROTECTION PRODUCTS**Applications Information****Device Connection Options**

The μ Clamp2511T is designed to protect one data line operating up to 2.5 volts. It will present a high impedance to the protected line up to 2.5 volts. It will “turn on” when the line voltage exceeds 2.7 volts. The device is bidirectional and may be used on lines where the signal polarity is above and below ground. These devices are not recommended for use on DC power supply lines due to their snap-back voltage characteristic.

EPD TVS Characteristics

These devices are constructed using Semtech’s proprietary EPD technology. The structure of the EPD TVS is vastly different from the traditional pn-junction devices. At voltages below 5V, high leakage current and junction capacitance render conventional avalanche technology impractical for most applications. However, by utilizing the EPD technology, these devices can effectively operate at 2.5V while maintaining excellent electrical characteristics.

The EPD TVS employs a complex npnp structure in contrast to the pn structure normally found in traditional silicon-avalanche TVS diodes. The EPD mechanism is achieved by engineering the center region of the device such that the reverse biased junction does not avalanche, but will “punch-through” to a conducting state. This structure results in a device with superior DC electrical parameters at low voltages while maintaining the capability to absorb high transient currents.

Circuit Board Layout Recommendations for Suppression of ESD.

Good circuit board layout is critical for the suppression of ESD induced transients. The following guidelines are recommended:

- Place the TVS near the input terminals or connectors to restrict transient coupling.
- Minimize the path length between the TVS and the protected line.
- Minimize all conductive loops including power and ground loops.
- The ESD transient return path to ground should be kept as short as possible.
- Never run critical signals near board edges.
- Use ground planes whenever possible.

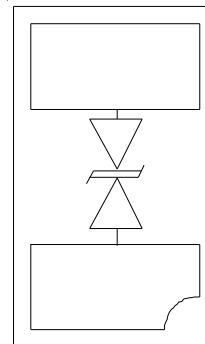
Device Schematic & Pin Configuration

PROTECTION PRODUCTS

Applications Information - Spice Model

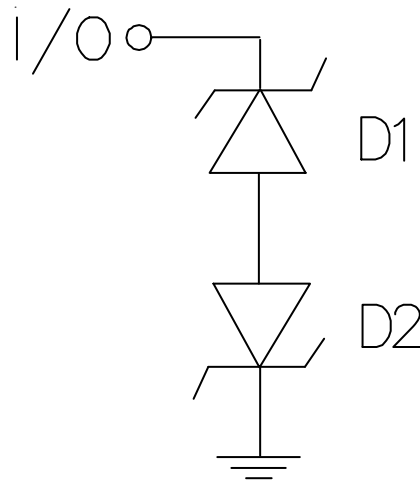

Spice Model

uClamp2511T Spice Parameters			
Parameter	Unit	D1 (TVS)	D2 (TVS)
IS	Amp	1E-20	1E-20
BV	Volt	2.2	2.2
VJ	Volt	0.7	0.7
RS	Ohm	0.3	0.3
IBV	Amp	1E-3	1E-3
CJO	Farad	12E-12	12E-12
TT	sec	2.541E-9	2.541E-9
M	--	0.05	0.05
N	--	1.1	1.1
EG	eV	1.11	1.11

PROTECTION PRODUCTS

Outline Drawing - SLP1006P2T

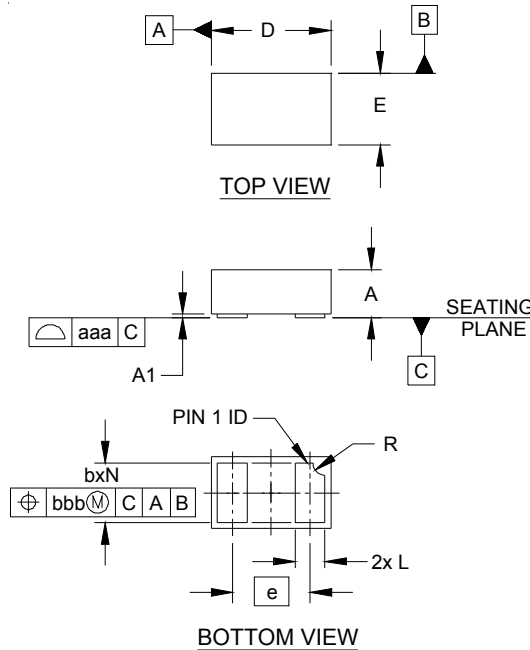

DIM	INCHES			MILLIMETERS		
	MIN	NOM	MAX	MIN	NOM	MAX
A	.015	.016	.017	0.37	0.40	0.43
A1	.000	.001	.002	0.00	0.03	0.05
b	.018	.020	.022	0.45	0.50	0.55
D	.035	.039	.043	0.90	1.00	1.10
E	.020	.024	.028	0.50	0.60	0.70
e	.026 BSC			0.65 BSC		
L	.008	.010	.012	0.20	0.25	0.30
R	.002	.004	.006	0.05	0.10	0.15
N	2			2		
aaa	.003			0.08		
bbb	.004			0.10		

NOTES:

1. CONTROLLING DIMENSIONS ARE IN MILLIMETERS (ANGLES IN DEGREES).

Land Pattern - SLP1006P2T

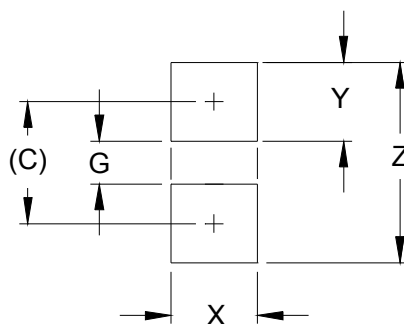

DIM	DIMENSIONS	
	INCHES	MILLIMETERS
C	(.033)	(0.85)
G	.012	0.30
X	.024	0.60
Y	.022	0.55
Z	.055	1.40

NOTES:

1. CONTROLLING DIMENSIONS ARE IN MILLIMETERS (ANGLES IN DEGREES).
2. THIS LAND PATTERN IS FOR REFERENCE PURPOSES ONLY.
CONSULT YOUR MANUFACTURING GROUP TO ENSURE YOUR COMPANY'S MANUFACTURING GUIDELINES ARE MET.

PROTECTION PRODUCTS

Marking Code

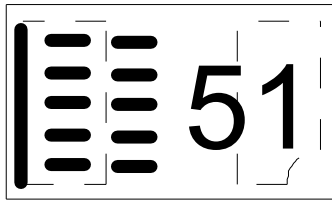

Notes:

- 1) Marking will also include line matrix date code
- 2) Device is electrically symmetrical

Ordering Information

Part Number	Working Voltage	Qty per Reel	Reel Size
uClamp2511T.TCT	2.5V	3,000	7 Inch

Notes:

- 1) This is a lead-free, RoHS/WEEE compliant product
- MicroClamp, uClamp and μ Clamp are marks of Semtech Corporation

Tape and Reel Specification

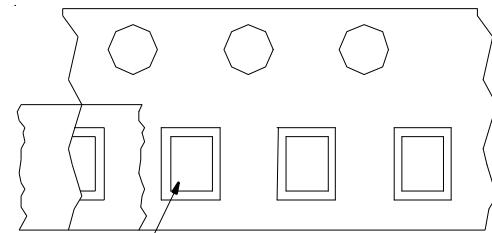
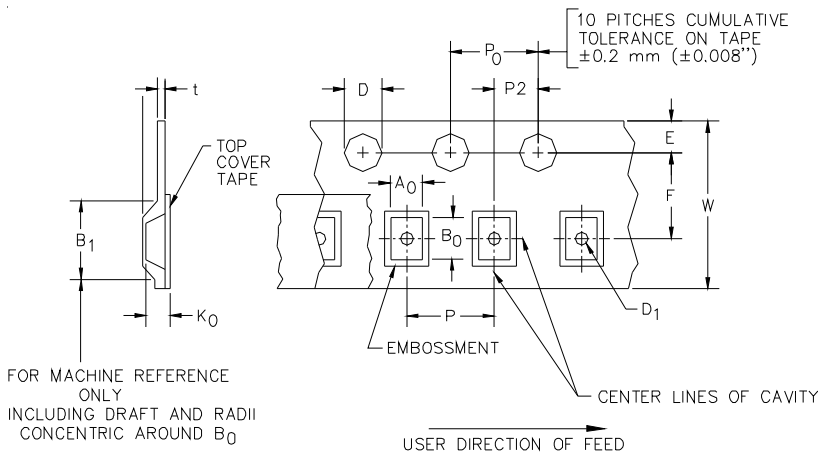

Pin 1 Location

→ User Direction of feed

Device Orientation in Tape

A0	B0	K0
0.69 +/-0.10 mm	1.19 +/-0.10 mm	0.66 +/-0.10 mm

Tape Width	B, (Max)	D	D1	E	F	P	P0	P2	T	W
8 mm	4.2 mm (.165)	1.5 + 0.1 mm - 0.0 mm (0.59 +.005 - .000)	0.4 mm ± 0.25 (.031)	1.750 $\pm .10$ mm (.069 $\pm .004$)	3.5 ± 0.05 mm (.138 $\pm .002$)	4.0 ± 0.10 mm (.157 $\pm .004$)	4.0 ± 0.1 mm (.157 $\pm .004$)	2.0 ± 0.05 mm (.079 $\pm .002$)	0.254 ± 0.02 mm (.016)	8.0 mm + 0.3 mm - 0.1 mm (.312 $\pm .012$)

Contact Information

Semtech Corporation
 Protection Products Division
 200 Flynn Rd., Camarillo, CA 93012
 Phone: (805)498-2111 FAX (805)498-3804



**Стандарт
Электрон
Связь**

Мы молодая и активно развивающаяся компания в области поставок электронных компонентов. Мы поставляем электронные компоненты отечественного и импортного производства напрямую от производителей и с крупнейших складов мира.

Благодаря сотрудничеству с мировыми поставщиками мы осуществляем комплексные и плановые поставки широчайшего спектра электронных компонентов.

Собственная эффективная логистика и склад в обеспечивает надежную поставку продукции в точно указанные сроки по всей России.

Мы осуществляем техническую поддержку нашим клиентам и предпродажную проверку качества продукции. На все поставляемые продукты мы предоставляем гарантию .

Осуществляем поставки продукции под контролем ВП МО РФ на предприятия военно-промышленного комплекса России , а также работаем в рамках 275 ФЗ с открытием отдельных счетов в уполномоченном банке. Система менеджмента качества компании соответствует требованиям ГОСТ ISO 9001.

Минимальные сроки поставки, гибкие цены, неограниченный ассортимент и индивидуальный подход к клиентам являются основой для выстраивания долгосрочного и эффективного сотрудничества с предприятиями радиоэлектронной промышленности, предприятиями ВПК и научно-исследовательскими институтами России.

С нами вы становитесь еще успешнее!

Наши контакты:

Телефон: +7 812 627 14 35

Электронная почта: sales@st-electron.ru

Адрес: 198099, Санкт-Петербург,
Промышленная ул, дом № 19, литера Н,
помещение 100-Н Офис 331