

SJxx10xSx & SJxx10xx Series

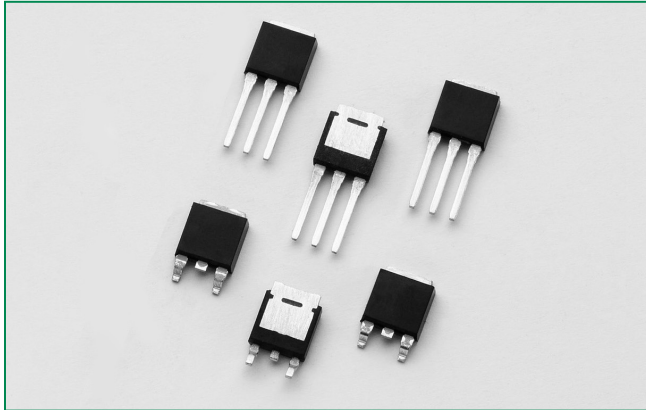

Main Features

| Symbol | Value | Unit |
|-------------------|------------|------|
| $I_{T(RMS)}$ | 10 | A |
| V_{DRM}/V_{RRM} | 400 or 600 | V |
| I_{GT} | 0.2 to 15 | mA |

Schematic Symbol

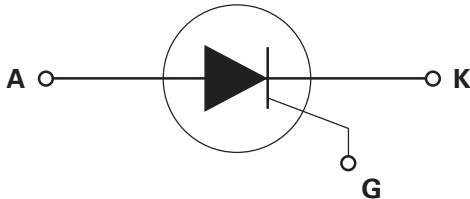

Description

This SJxx10xx high temperature SCR series is ideal for uni-directional switch applications such as phase control, heating, motor speed controls, converters/rectifiers and capacitive discharge ignitions.

These SCRs have a low gate current trigger level of 6mA or 15mA maximum at approximately 1.5V, with a sensitive version of this series having a gate trigger current less than 200 μ A. The sensitive gate SCR version is easily triggered by sense coils, proximity switches, and microprocessors.

Features & Benefits

- Voltage capability up to 600 V
- Surge capability up to 100 A at 60 Hz half cycle
- 150 °C maximum junction temperature
- Halogen free and RoHS compliant

Applications

Typical applications includes capacitive discharge system for motorcycle engine CDI, portable generator engine ignition, strobe lights and nailers, as well as generic rectifiers, battery voltage regulators and converters. Also controls for power tools, home/brown goods and white goods appliances.

Absolute Maximum Ratings – Sensitive SCRs

| Symbol | Parameter | Test Conditions | Value | Unit |
|-------------------|---|--|-------------------------|------------------------|
| $I_{T(RMS)}$ | RMS on-state current | $T_c = 120\text{ }^\circ\text{C}$ | 10 | A |
| $I_{T(AV)}$ | Average on-state current | $T_c = 120\text{ }^\circ\text{C}$ | 6.4 | A |
| I_{TSM} | Peak non-repetitive surge current | single half cycle; $f = 50\text{ Hz}$; $T_J(\text{initial}) = 25\text{ }^\circ\text{C}$ | 83 | A |
| | | single half cycle; $f = 60\text{ Hz}$; $T_J(\text{initial}) = 25\text{ }^\circ\text{C}$ | 100 | |
| I^2t | I^2t Value for fusing | $t_p = 8.3\text{ ms}$ | 41 | A^2s |
| di/dt | Critical rate of rise of on-state current | $f = 60\text{ Hz}, T_J = 150\text{ }^\circ\text{C}$ | 100 | $\text{A}/\mu\text{s}$ |
| I_{GM} | Peak gate current | $P_w = 20\text{ }\mu\text{s}, T_J = 150\text{ }^\circ\text{C}$ | 0.5 | A |
| $P_{G(AV)}$ | Average gate power dissipation | $T_J = 150\text{ }^\circ\text{C}$ | 0.1 | W |
| T_{stg} | Storage temperature range | | -40 to 150 | $^\circ\text{C}$ |
| T_J | Operating junction temperature range | | -40 to 150 | $^\circ\text{C}$ |
| V_{DSM}/V_{RSM} | Peak non-repetitive blocking voltage | $P_w = 100\text{ }\mu\text{s}$ | $V_{DRM}/V_{RRM} + 100$ | V |

Absolute Maximum Ratings – Standard SCRs

| Symbol | Parameter | Test Conditions | Value | Unit |
|-------------------|---|---|-------------------------|------------------------|
| $I_{T(RMS)}$ | RMS on-state current | $T_C = 125\text{ }^\circ\text{C}$ | 10 | A |
| $I_{T(AV)}$ | Average on-state current | $T_C = 125\text{ }^\circ\text{C}$ | 6.4 | A |
| I_{TSM} | Peak non-repetitive surge current | single half cycle; $f = 50\text{ Hz}$; $T_J(\text{initial}) = 25\text{ }^\circ\text{C}$ | 83 | A |
| | | single half cycle; $f = 60\text{ Hz}$; $T_J(\text{initial}) = 25\text{ }^\circ\text{C}$ | 100 | |
| I^2t | I^2t Value for fusing | $t_p = 8.3\text{ ms}$ | 41 | A^2s |
| di/dt | Critical rate-of-rise of on-state current | $f = 60\text{ Hz}$, $T_J = 150\text{ }^\circ\text{C}$ | 100 | $\text{A}/\mu\text{s}$ |
| I_{GM} | Peak gate current | $Pw=20\text{ }\mu\text{s}$, $T_J = 150\text{ }^\circ\text{C}$ | 0.5 | A |
| $P_{G(AV)}$ | Average gate power dissipation | $T_J = 150\text{ }^\circ\text{C}$ | 0.1 | W |
| T_{stg} | Storage temperature range | | -40 to 150 | $^\circ\text{C}$ |
| T_J | Operating junction temperature range | | -40 to 150 | $^\circ\text{C}$ |
| V_{DSM}/V_{RSM} | Peak non-repetitive blocking voltage | $Pw=100\text{ }\mu\text{s}$ | $V_{DRM}/V_{RRM} + 100$ | V |

Electrical Characteristics ($T_J = 25\text{ }^\circ\text{C}$, unless otherwise specified) – Sensitive SCRs

| Symbol | Test Conditions | | Value | Unit |
|-----------|---|------|-----------|------------------------|
| | | | SJxx10xS2 | |
| I_{GT} | $V_D = 6\text{ V}$, $R_L = 100\text{ }\Omega$ | MIN. | 20 | μA |
| | | MAX. | 200 | μA |
| V_{GT} | | MAX. | 0.8 | V |
| dv/dt | $V_D = V_{DRM}$; $R_{GK} = 220\text{ }\Omega$; $T_J = 125\text{ }^\circ\text{C}$ | MIN. | 15 | $\text{V}/\mu\text{s}$ |
| V_{GD} | $V_D = V_{DRM}$; $R_L = 3.3\text{ k}\Omega$; $T_J = 125\text{ }^\circ\text{C}$ | MIN. | 0.2 | V |
| | $V_D = V_{DRM}$; $R_L = 3.3\text{ k}\Omega$; $T_J = 150\text{ }^\circ\text{C}$ | MIN. | 0.1 | V |
| V_{GRM} | $I_{GR} = 10\text{ }\mu\text{A}$ | MIN. | 6 | V |
| I_H | $I_T = 20\text{ mA}$ (initial) | MAX. | 6 | mA |
| t_q | $t_p=50\mu\text{s}$; $dv/dt=5\text{V}/\mu\text{s}$; $di/dt=-30\text{A}/\mu\text{s}$ | MAX. | 130 | μs |
| t_{gt} | $I_G = 2 \times I_{GT}$; $PW = 15\mu\text{s}$; $I_T = 10\text{ A}$ | TYP. | 6 | μs |

NOTE: xx = voltage

Electrical Characteristics ($T_J = 25\text{ }^\circ\text{C}$, unless otherwise specified) – Standard SCRs

| Symbol | Test Conditions | | Value | | Unit |
|----------|---|------|----------|---------|------------------------|
| | | | SJxx10x1 | SJxx10x | |
| I_{GT} | $V_D = 12\text{ V}$, $R_L = 60\text{ }\Omega$ | MAX. | 6 | 15 | mA |
| V_{GT} | | MAX. | 1.5 | 1.5 | V |
| dv/dt | $V_D = V_{DRM}$; gate open; $T_J = 125\text{ }^\circ\text{C}$ | MIN. | 100 | 200 | $\text{V}/\mu\text{s}$ |
| | $V_D = V_{DRM}$; gate open; $T_J = 150\text{ }^\circ\text{C}$ | | 50 | 120 | |
| V_{GD} | $V_D = V_{DRM}$; $R_L = 3.3\text{ k}\Omega$; $T_J = 125\text{ }^\circ\text{C}$ | MIN. | 0.2 | 0.2 | V |
| | $V_D = V_{DRM}$; $R_L = 3.3\text{ k}\Omega$; $T_J = 150\text{ }^\circ\text{C}$ | MIN. | 0.1 | 0.1 | |
| I_H | $I_T = 200\text{ mA}$ (initial) | MAX. | 20 | 30 | mA |
| t_q | $I_T=0.5\text{A}$; $t_p=50\mu\text{s}$; $dv/dt=5\text{V}/\mu\text{s}$; $di/dt=-30\text{A}/\mu\text{s}$ | MAX. | 30 | 35 | μs |
| t_{gt} | $I_G = 2 \times I_{GT}$; $PW = 15\mu\text{s}$; $I_T = 10\text{ A}$ | TYP. | 0.5 | 2 | μs |

NOTE: xx = voltage

Static Characteristics

| Symbol | Test Conditions | | Value | Unit | | | |
|---------------------|------------------------------|-----------|---------------------|--|------------|------|---------|
| V_{TM} | $I_T = 20A; t_p = 380 \mu s$ | | MAX. | 1.6 | V | | |
| I_{DRM} / I_{RRM} | @ V_{DRM} / V_{RRM} | SJxx10xS2 | MAX. | $T_J = 25^\circ C$ | 400 - 600V | 5 | μA |
| | | | | $T_J = 125^\circ C, R_{GK} = 220 \Omega$ | 400 - 600V | 1000 | |
| | | | | $T_J = 150^\circ C, R_{GK} = 220 \Omega$ | 400 - 600V | 3000 | |
| | | SJxx10xx | $T_J = 25^\circ C$ | 400 - 600V | 10 | | |
| | | | $T_J = 125^\circ C$ | 400 - 600V | 1000 | | |
| | | | $T_J = 150^\circ C$ | 400 - 600V | 3000 | | |

Thermal Resistances

| Symbol | Parameter | Value | Unit |
|-------------------|-----------------------|-----------|------|
| $R_{\theta(J-C)}$ | Junction to case (AC) | SJxx10xS2 | 1.2 |
| | | SJxx10xx | 1.2 |

Note: xx = voltage

Figure 1: Normalized DC Gate Trigger Current vs. Junction Temperature (Sensitive SCR)

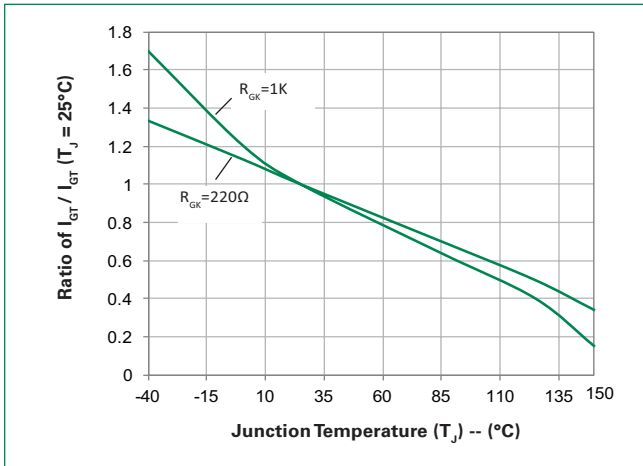

Figure 2: Normalized DC Gate Trigger Current vs. Junction Temperature (Standard SCR)

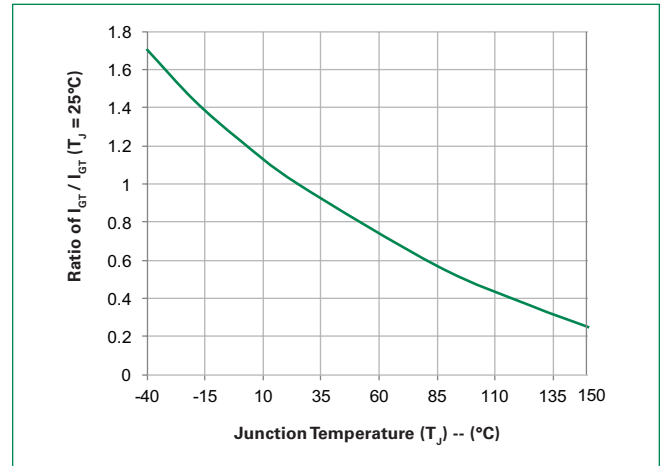

Figure 3: Normalized DC Gate Trigger Voltage vs. Junction Temperature



Figure 4: Normalized DC Holding Current vs. Junction Temperature

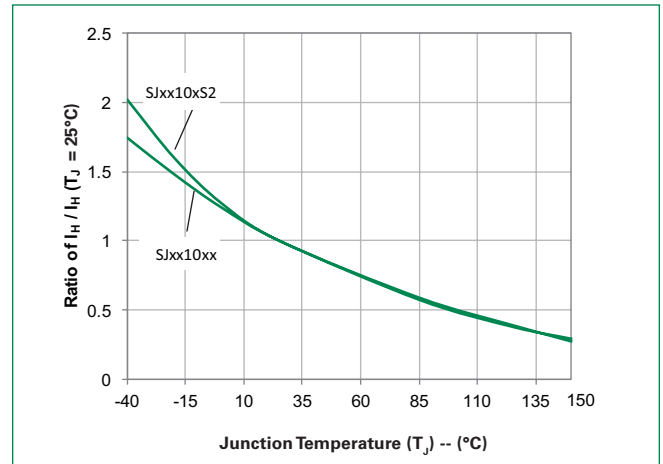

Figure 5: On-State Current vs. On-State Voltage (Typical)

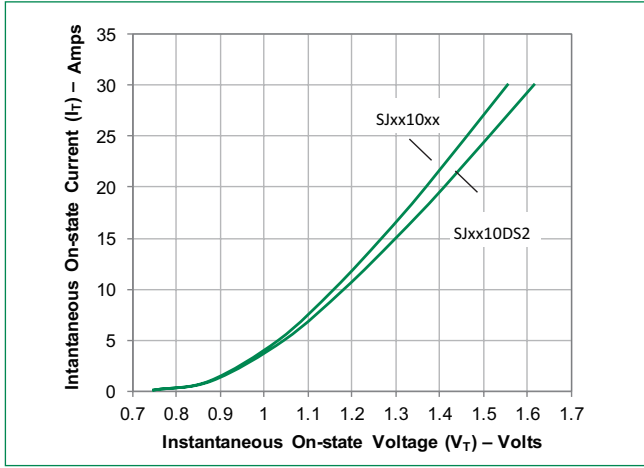

Figure 6: Power Dissipation (Typical) vs. RMS On-State Current

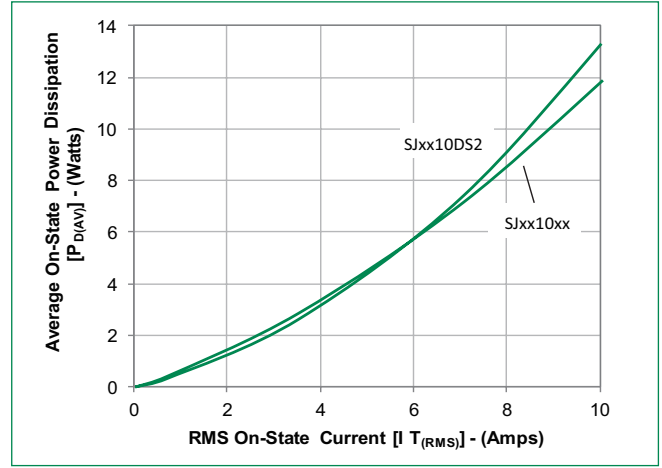

Figure 7: Maximum Allowable Case Temperature vs. RMS On-State Current

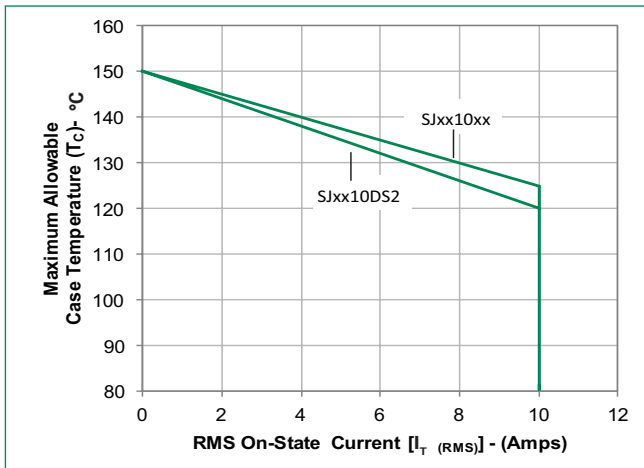

Figure 8: Maximum Allowable Case Temperature vs. Average On-State Current

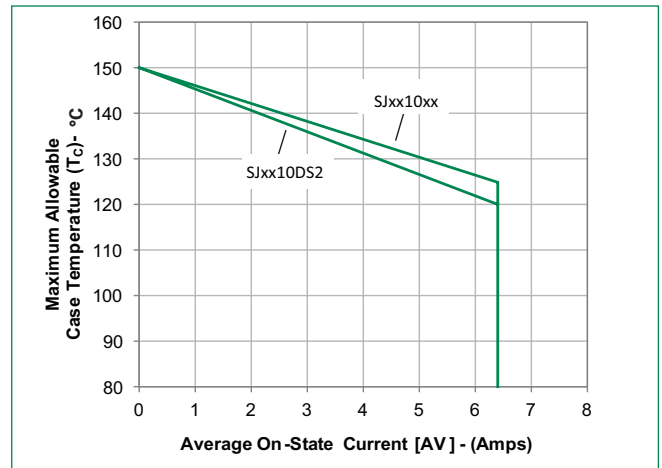

Figure 9: Peak Capacitor Discharge Current

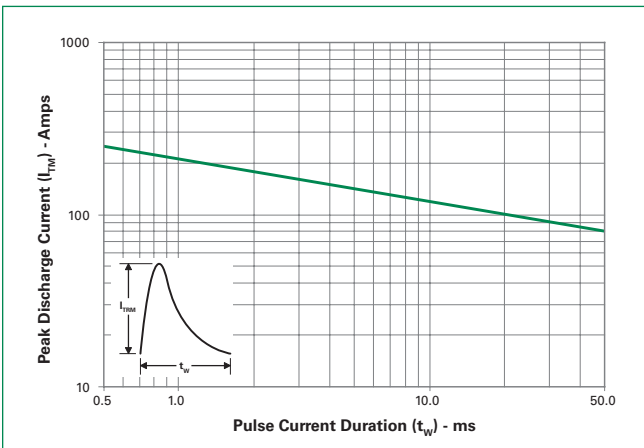

Figure 10: Surge Peak On-State Current vs. Number of Cycles

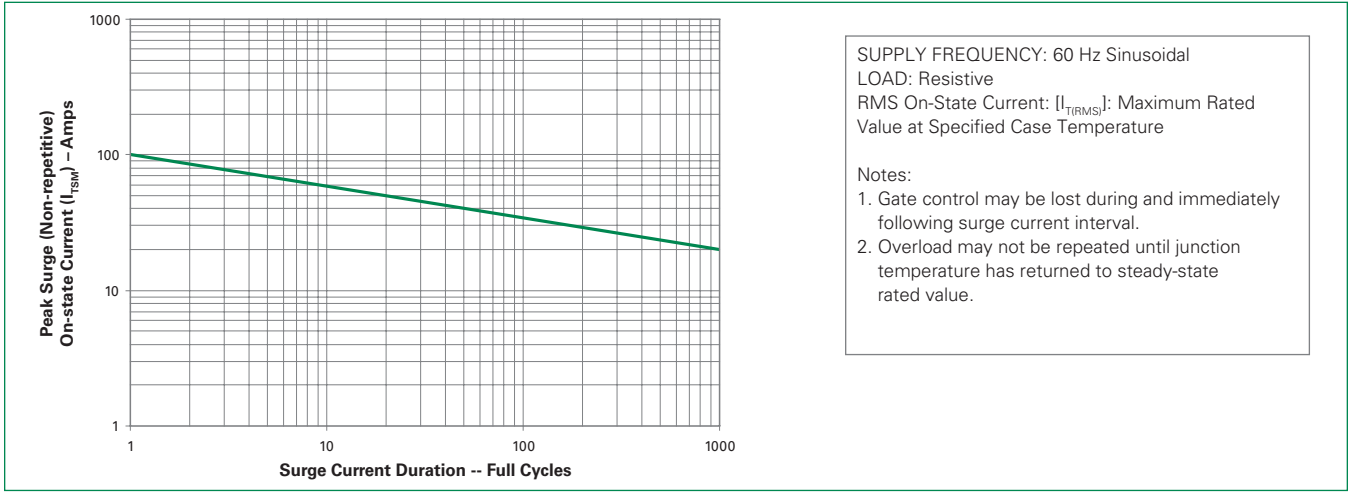

Figure 11: Typical DC Gate Trigger Current with R_{GK} vs. Junction Temperature (Sensitive SCR)



Figure 12: Typical DC Holding Current with R_{GK} vs. Junction Temperature (Sensitive SCR)

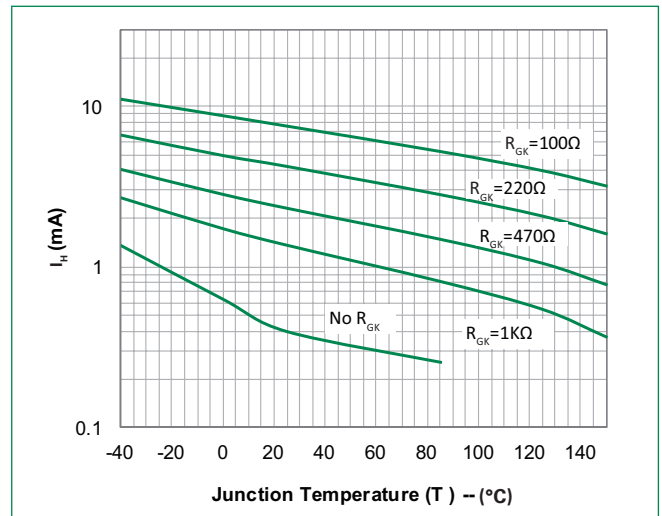
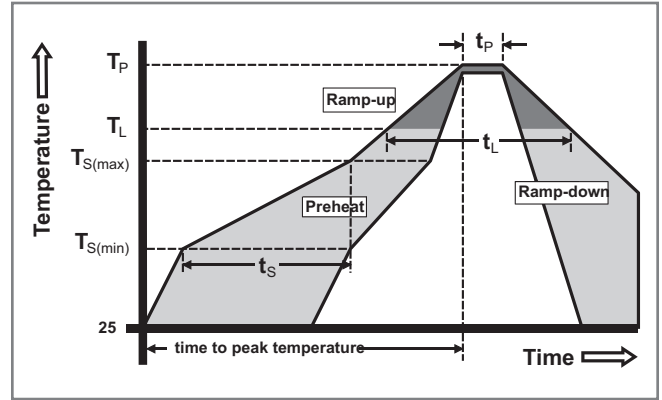

Figure 13: Typical Static dv/dt with R_{GK} vs. Junction Temperature (Sensitive SCR)



Soldering Parameters

| | | |
|--|------------------------------------|-------------------------|
| Reflow Condition | | Pb – Free assembly |
| Pre Heat | - Temperature Min ($T_{s(min)}$) | 150°C |
| | - Temperature Max ($T_{s(max)}$) | 200°C |
| | - Time (min to max) (t_s) | 60 – 180 secs |
| Average ramp up rate (Liquidus Temp) (T_L) to peak | | 5°C/second max |
| $T_{s(max)}$ to T_L - Ramp-up Rate | | 5°C/second max |
| Reflow | - Temperature (T_L) (Liquidus) | 217°C |
| | - Time (t_L) | 60 – 150 seconds |
| Peak Temperature (T_p) | | 260 ^{+0/-5} °C |
| Time within 5°C of actual peak Temperature (t_p) | | 20 – 40 seconds |
| Ramp-down Rate | | 5°C/second max |
| Time 25°C to peak Temperature (T_p) | | 8 minutes Max. |
| Do not exceed | | 280°C |



Physical Specifications

| | |
|------------------------|---|
| Terminal Finish | 100% Matte Tin-plated |
| Body Material | UL Recognized epoxy meeting flammability rating V-0 |
| Lead Material | Copper Alloy |

Design Considerations

Careful selection of the correct component for the application's operating parameters and environment will go a long way toward extending the operating life of the Thyristor. Good design practice should limit the maximum continuous current through the main terminals to 75% of the component rating. Other ways to ensure long life for a power discrete semiconductor are proper heat sinking and selection of voltage ratings for worst case conditions. Overheating, overvoltage (including dv/dt), and surge currents are the main killers of semiconductors. Correct mounting, soldering, and forming of the leads also help protect against component damage.

Environmental Specifications

| Test | Specifications and Conditions |
|-----------------------------------|--|
| AC Blocking | MIL-STD-750, M-1040, Cond A Applied Peak AC voltage for 1008 hours |
| Temperature Cycling | MIL-STD-750, M-1051, 100 cycles; -40°C to +150°C; 15-min dwell-time |
| Temperature/Humidity | EIA / JEDEC, JESD22-A101 1008 hours; 160V - DC: 85°C; 85% rel humidity |
| High Temp Storage | MIL-STD-750, M-1031, 1008 hours; 150°C |
| Low-Temp Storage | 1008 hours; -40°C |
| Resistance to Solder Heat | MIL-STD-750 Method 2031 |
| Solderability | ANSI/J-STD-002, category 3, Test A |
| Lead Bend | MIL-STD-750, M-2036 Cond E |
| Moisture Sensitivity Level | Level 1, JEDEC-J-STD-020 |

Part Numbering System



Part Marking System

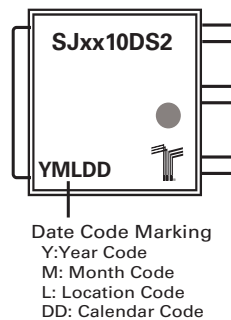

Dimensions — TO-251AA (V/I-Package) — V/I-PAK Through Hole

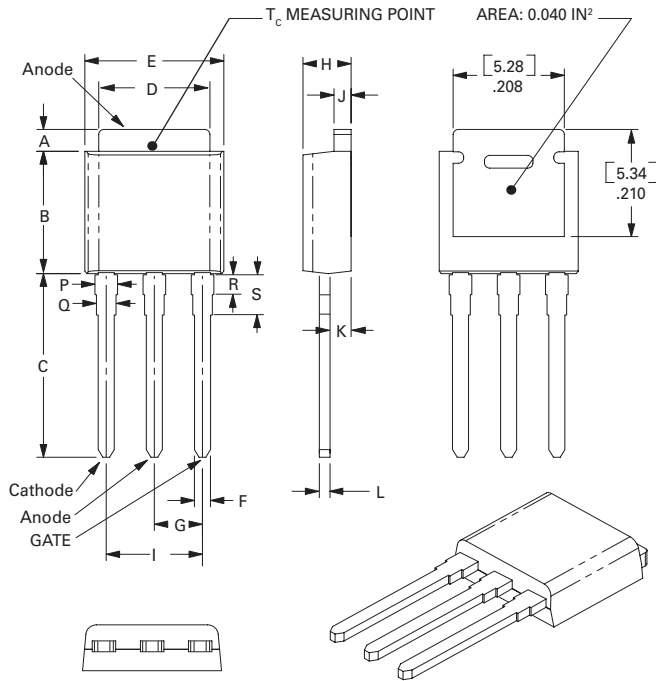

| Dimension | Inches | | | Millimeters | | |
|-----------|--------|-------|-------|-------------|------|------|
| | Min | Typ | Max | Min | Typ | Max |
| A | 0.037 | 0.040 | 0.043 | 0.94 | 1.01 | 1.09 |
| B | 0.235 | 0.242 | 0.245 | 5.97 | 6.15 | 6.22 |
| C | 0.350 | 0.361 | 0.375 | 8.89 | 9.18 | 9.53 |
| D | 0.205 | 0.208 | 0.213 | 5.21 | 5.29 | 5.41 |
| E | 0.255 | 0.262 | 0.265 | 6.48 | 6.66 | 6.73 |
| F | 0.027 | 0.031 | 0.033 | 0.69 | 0.80 | 0.84 |
| G | 0.087 | 0.090 | 0.093 | 2.21 | 2.28 | 2.36 |
| H | 0.085 | 0.092 | 0.095 | 2.16 | 2.34 | 2.41 |
| I | 0.176 | 0.180 | 0.184 | 4.47 | 4.57 | 4.67 |
| J | 0.018 | 0.020 | 0.023 | 0.46 | 0.51 | 0.58 |
| K | 0.035 | 0.037 | 0.039 | 0.90 | 0.95 | 1.00 |
| L | 0.018 | 0.020 | 0.023 | 0.46 | 0.52 | 0.58 |
| P | 0.042 | 0.047 | 0.052 | 1.06 | 1.20 | 1.32 |
| Q | 0.034 | 0.039 | 0.044 | 0.86 | 1.00 | 1.11 |
| R | 0.034 | 0.039 | 0.044 | 0.86 | 1.00 | 1.11 |
| S | 0.074 | 0.079 | 0.084 | 1.86 | 2.00 | 2.11 |

Dimensions — TO-252AA (D-Package) — D-PAK Surface Mount

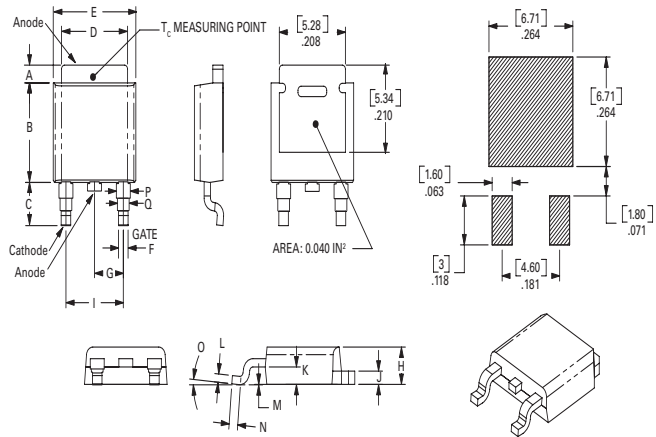

| Dimension | Inches | | | Millimeters | | |
|-----------|--------|-------|-------|-------------|------|------|
| | Min | Typ | Max | Min | Typ | Max |
| A | 0.037 | 0.040 | 0.043 | 0.94 | 1.01 | 1.09 |
| B | 0.235 | 0.243 | 0.245 | 5.97 | 6.16 | 6.22 |
| C | 0.106 | 0.108 | 0.113 | 2.69 | 2.74 | 2.87 |
| D | 0.205 | 0.208 | 0.213 | 5.21 | 5.29 | 5.41 |
| E | 0.255 | 0.262 | 0.265 | 6.48 | 6.65 | 6.73 |
| F | 0.027 | 0.031 | 0.033 | 0.69 | 0.80 | 0.84 |
| G | 0.087 | 0.090 | 0.093 | 2.21 | 2.28 | 2.36 |
| H | 0.085 | 0.092 | 0.095 | 2.16 | 2.33 | 2.41 |
| I | 0.176 | 0.179 | 0.184 | 4.47 | 4.55 | 4.67 |
| J | 0.018 | 0.020 | 0.023 | 0.46 | 0.51 | 0.58 |
| K | 0.035 | 0.037 | 0.039 | 0.90 | 0.95 | 1.00 |
| L | 0.018 | 0.020 | 0.023 | 0.46 | 0.51 | 0.58 |
| M | 0.000 | 0.000 | 0.004 | 0.00 | 0.00 | 0.10 |
| N | 0.021 | 0.026 | 0.027 | 0.53 | 0.67 | 0.69 |
| O | 0° | 0° | 5° | 0° | 0° | 5° |
| P | 0.042 | 0.047 | 0.052 | 1.06 | 1.20 | 1.32 |
| Q | 0.034 | 0.039 | 0.044 | 0.86 | 1.00 | 1.11 |

TO-252 Embossed Carrier Reel Pack (RP) Specifications

Meets all EIA-481-2 Standards

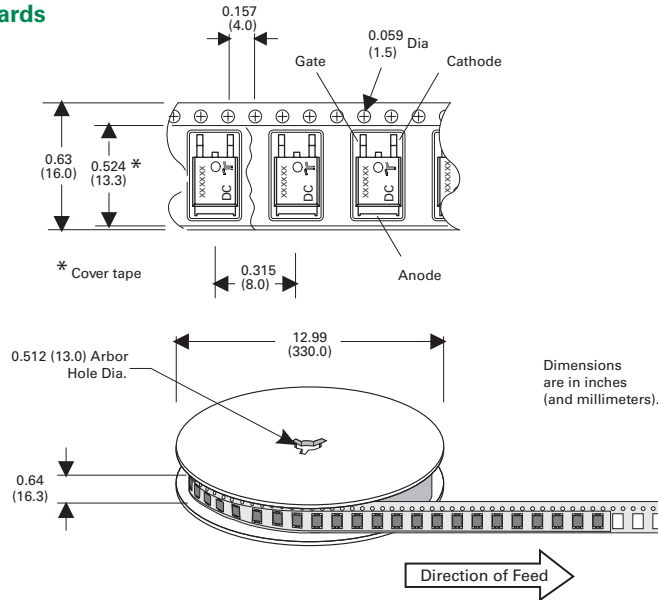

Product Selector

| Part Number | Voltage | | Gate Sensitivity | Type | Package |
|-------------|---------|------|------------------|---------------|---------|
| | 400V | 600V | | | |
| SJxx10VS2 | X | X | 0.2mA | Sensitive SCR | TO-251 |
| SJxx10DS2 | X | X | 0.2mA | Sensitive SCR | TO-252 |
| SJxx10V | X | X | 15mA | Standard SCR | TO-251 |
| SJxx10D | X | X | 15mA | Standard SCR | TO-252 |
| SJxx10V1 | X | X | 6mA | Standard SCR | TO-251 |
| SJxx10D1 | X | X | 6mA | Standard SCR | TO-252 |

Note: xx = Voltage

Packing Options

| Part Number | Marking | Weight | Packing Mode | Base Quantity |
|-------------|-----------|--------|------------------|-------------------|
| SJxx10DS2TP | SJxx10DS2 | 0.3 g | Tube | 750 (75 per tube) |
| SJxx10DS2RP | SJxx10DS2 | 0.3 g | Embossed Carrier | 2500 |
| SJxx10VS2TP | SJxx10VS2 | 0.4 g | Tube | 750 (75 per tube) |
| SJxx10DTP | SJxx10D | 0.3 g | Tube | 750 (75 per tube) |
| SJxx10DRP | SJxx10D | 0.3 g | Embossed Carrier | 2500 |
| SJxx10VTP | SJxx10V | 0.4 g | Tube | 750 (75 per tube) |
| SJxx10D1TP | SJxx10D1 | 0.3 g | Tube | 750 (75 per tube) |
| SJxx10D1RP | SJxx10D1 | 0.3 g | Embossed Carrier | 2500 |
| SJxx10V1TP | SJxx10V1 | 0.4 g | Tube | 750 (75 per tube) |

Note: xx = Voltage

Disclaimer Notice - Information furnished is believed to be accurate and reliable. However, users should independently evaluate the suitability of and test each product selected for their own applications. Littelfuse products are not designed for, and may not be used in, all applications. Read complete Disclaimer Notice at www.littelfuse.com/disclaimer-electronics.



Стандарт Электрон Связь

Мы молодая и активно развивающаяся компания в области поставок электронных компонентов. Мы поставляем электронные компоненты отечественного и импортного производства напрямую от производителей и с крупнейших складов мира.

Благодаря сотрудничеству с мировыми поставщиками мы осуществляем комплексные и плановые поставки широчайшего спектра электронных компонентов.

Собственная эффективная логистика и склад в обеспечивает надежную поставку продукции в точно указанные сроки по всей России.

Мы осуществляем техническую поддержку нашим клиентам и предпродажную проверку качества продукции. На все поставляемые продукты мы предоставляем гарантию .

Осуществляем поставки продукции под контролем ВП МО РФ на предприятия военно-промышленного комплекса России , а также работаем в рамках 275 ФЗ с открытием отдельных счетов в уполномоченном банке. Система менеджмента качества компании соответствует требованиям ГОСТ ISO 9001.

Минимальные сроки поставки, гибкие цены, неограниченный ассортимент и индивидуальный подход к клиентам являются основой для выстраивания долгосрочного и эффективного сотрудничества с предприятиями радиоэлектронной промышленности, предприятиями ВПК и научно-исследовательскими институтами России.

С нами вы становитесь еще успешнее!

Наши контакты:

Телефон: +7 812 627 14 35

Электронная почта: sales@st-electron.ru

Адрес: 198099, Санкт-Петербург,
Промышленная ул, дом № 19, литера Н,
помещение 100-Н Офис 331