

FEATURES

Conversion gain: 12 dB typical
Sideband rejection: 20 dBc typical
OP1dB compression: 20 dBm typical
OIP3: 27 dBm typical
2× LO to RF isolation: 10 dB typical
2× LO to IF isolation: 15 dB typical
RF return loss: 12 dB typical
LO return loss: 15 dB typical
IF return loss: 15 dB typical
Exposed pad, 4.90 mm × 4.90 mm, 32-terminal, ceramic LCC

APPLICATIONS

Point to point and point to multipoint radios
Military radars, electronic warfare, and electronic intelligence
Satellite communications
Sensors

GENERAL DESCRIPTION

The HMC815B is a compact gallium arsenide (GaAs), pseudomorphic high electron mobility transistor (pHEMT), monolithic microwave integrated circuit (MMIC) upconverter in a RoHS compliant package that operates from 21 GHz to 27 GHz. This device provides a small signal conversion gain of 12 dB and a sideband rejection of 20 dBc. The HMC815B utilizes a driver amplifier preceded by an in phase/quadrature (I/Q) mixer where the LO is driven by an active 2× multiplier. IF1 and IF2 mixer inputs are provided, and an external 90° hybrid is needed to select the required sideband. The I/Q mixer topology reduces the need for filtering of unwanted sideband.

FUNCTIONAL BLOCK DIAGRAM

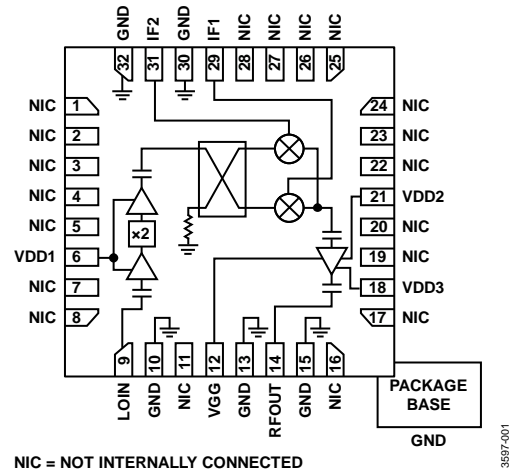

Figure 1.

The HMC815B is a smaller alternative to hybrid style single sideband (SSB) downconverter assemblies, and it eliminates the need for wire bonding by allowing the use of surface-mount manufacturing techniques.

The HMC815B is available in 4.90 mm × 4.90 mm, 32-terminal ceramic LCC package and operates over the -40°C to +85°C temperature range. An evaluation board for the HMC815B is also available upon request.

TABLE OF CONTENTS

Features	1	IF = 100 MHz, IF Input Power = 0 dBm, Upper Sideband (Low-Side LO)	13
Applications	1	IF = 2500 MHz, RF Input Power = 0 dBm, Upper Sideband (Low-Side LO)	15
Functional Block Diagram	1	IF = 3750 MHz, RF Input Power = 0 dBm, Upper Sideband (Low-Side LO)	17
General Description	1	Isolation and Return Loss	19
Revision History	2	IF Bandwidth Performance: Lower Sideband (High-Side LO) ..	22
Specifications	3	IF Bandwidth Performance: Upper Sideband (Low-Side LO) ...	23
Absolute Maximum Ratings	4	Spurious Performance	24
Thermal Resistance	4	Theory of Operation	26
ESD Caution	4	Applications Information	27
Pin Configuration and Function Descriptions	5	Typical Application Circuit	27
Interface Schematics	6	Evaluation Board Information	28
Typical Performance Characteristics	7	Outline Dimensions	30
IF = 2500 MHz, IF Input Power = 0 dBm, Lower Sideband (High-Side LO)	7	Ordering Guide	30
IF = 100 MHz, IF Input Power = 0 dBm, Lower Sideband (High-Side LO)	9		
IF = 3750 MHz, IF Input Power = 0 dBm, Lower Sideband (High-Side LO)	11		

REVISION HISTORY

1/2018—Revision 0: Initial Version

SPECIFICATIONS

$T_A = 25^\circ\text{C}$, intermediate frequency (IF) = 2500 MHz, $V_{DD1} = V_{DD2} = V_{DD3} = 4.5\text{ V}$, LO power = 4 dBm, unless otherwise noted. Measurements performed with lower sideband selected and an external 90° hybrid at the IF ports, unless otherwise noted.

Table 1.

Parameter	Symbol	Min	Typ	Max	Unit
OPERATING CONDITIONS					
Frequency Range					
Radio Frequency	RF	21		27	GHz
Local Oscillator	LO	10.5		14.5	GHz
Intermediate Frequency	IF	DC		3.75	GHz
LO Drive Range		0	4	6	dBm
PERFORMANCE					
Conversion Gain		7	12		dB
Sideband Rejection		12	20		dBc
Output Power for 1 dB Compression	OP1dB		20		dBm
Output Third-Order Intercept	OIP3	22.5	27		dBm
Isolation					
2× LO to RF		4	10		dB
2× LO to IF			15		dB
Return Loss					
RF			12		dB
LO			15		dB
IF			15		dB
POWER SUPPLY					
Total Drain Current					
RF Amplifier	$I_{DD2} + I_{DD3}$		270	300	mA
LO Amplifier	I_{DD1}		80	120	mA

ABSOLUTE MAXIMUM RATINGS

Table 2.

Parameter	Rating
Drain Bias Voltage (VDD1, VDD2, VDD3)	5.5 V
Input Power	
LO (LOIN)	15 dBm
IF (IF1, IF2)	20 dBm
IF Source/Sink Current	3 mA
Moisture Sensitivity Level (MSL) Rating ¹	MSL3
Maximum Junction Temperature	175°C
Storage Temperature Range	−65°C to +150°C
Operating Temperature Range	−40°C to +85°C
Reflow Temperature	260°C
Electrostatic Discharge Sensitivity	
Human Body Model (HBM)	250 V
Field Induced Charged Device Model (FICDM)	1250 V

¹ See the Ordering Guide section.

Stresses at or above those listed under Absolute Maximum Ratings may cause permanent damage to the product. This is a stress rating only; functional operation of the product at these or any other conditions above those indicated in the operational section of this specification is not implied. Operation beyond the maximum operating conditions for extended periods may affect product reliability.

THERMAL RESISTANCE

Thermal performance is directly linked to printed circuit board (PCB) design and operating environment. Careful attention to PCB thermal design is required.

θ_{JA} is the natural convection junction to ambient thermal resistance measured in a one cubic foot sealed enclosure. θ_{JC} is the junction to case thermal resistance.

Table 3. Thermal Resistance

Package Type	θ_{JA}	θ_{JC}	Unit
E-32-1 ¹	46.4	46.7	°C/W

¹ Thermal impedance simulated values are based on JEDEC 2S2P test board with 5 × 5 thermal vias. A cold plate is attached to the bottom side of the PCB using 100 μm tin (3.56 W/mK). Refer to JEDEC standard JESD51-2 for additional information.

ESD CAUTION



ESD (electrostatic discharge) sensitive device.

Charged devices and circuit boards can discharge without detection. Although this product features patented or proprietary protection circuitry, damage may occur on devices subjected to high energy ESD. Therefore, proper ESD precautions should be taken to avoid performance degradation or loss of functionality.

PIN CONFIGURATION AND FUNCTION DESCRIPTIONS

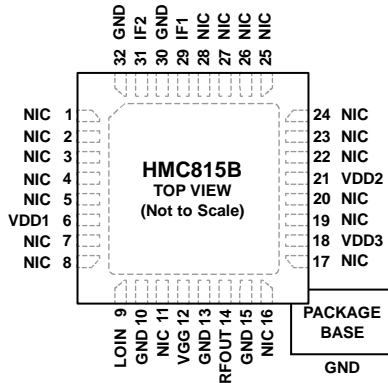

- NOTES**
1. NIC = NOT INTERNALLY CONNECTED. THESE PINS ARE NOT CONNECTED INTERNALLY. HOWEVER, THESE PINS CAN BE CONNECTED TO RF/DC GROUND WITHOUT AFFECTING PERFORMANCE.
 2. EXPOSED PAD. CONNECT THE EXPOSED PAD TO A LOW IMPEDANCE THERMAL AND ELECTRICAL GROUND PLANE.

13597-002

Figure 2. Pin Configuration

Table 4. Pin Function Descriptions

Pin No.	Mnemonic	Description
1 to 5, 7, 8, 11, 16, 17, 19, 20, 22 to 28	NIC	Not Internally Connected. These pins are not connected internally. However, these pins can be connected to RF/dc ground without affecting performance.
6	VDD1	Power Supply Voltage for the LO Amplifier. See Figure 3 for the interface schematic. Refer to the typical application circuit (see Figure 104) for the required external components.
9	LOIN	Local Oscillator Input. See Figure 4 for the interface schematic. This pin is ac-coupled and matched to 50 Ω.
10, 13, 15, 30, 32	GND	Ground Connect. See Figure 5 for the interface schematic. These pins and the exposed pad must be connected to RF/dc ground.
12	VGG	Gate Voltage for the RF Amplifier. See Figure 6 for the interface schematic. Refer to the typical application circuit (see Figure 104) for the required external components.
14	RFOUT	Radio Frequency Output. See Figure 7 for the interface schematic. This pin is ac-coupled and matched to 50 Ω.
18, 21	VDD3, VDD2	Power Supply Voltage for the RF Amplifier. See Figure 8 for the interface schematic. Refer to the typical application circuit (see Figure 104) for the required external components.
29, 31	IF1, IF2	Quadrature Intermediate Frequency Inputs. See Figure 9 for the interface schematic. For applications not requiring operation to dc, use an off chip dc blocking capacitor. For operation to dc, these pins must not source or sink more than 3 mA of current or device malfunction and failure can result.
	EPAD	Exposed Pad. Connect the exposed pad to a low impedance thermal and electrical ground plane.

INTERFACE SCHEMATICS

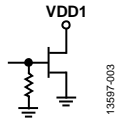

Figure 3. VDD1 Interface

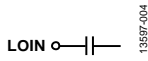

Figure 4. LOIN Interface



Figure 5. GND Interface

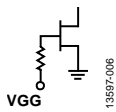

Figure 6. VGG Interface

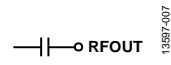

Figure 7. RFOUT Interface

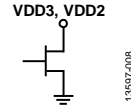

Figure 8. VDD3, VDD2 Interface

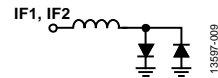

Figure 9. IF1, IF2 Interface

TYPICAL PERFORMANCE CHARACTERISTICS

IF = 2500 MHz, IF INPUT POWER = 0 dBm, LOWER SIDEBAND (HIGH-SIDE LO)

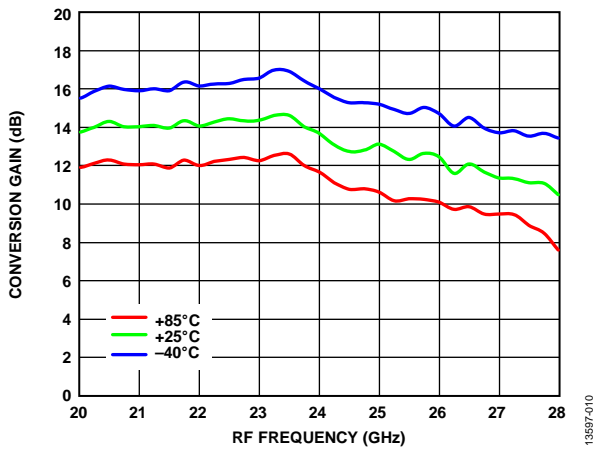

Figure 10. Conversion Gain vs. RF Frequency over Temperature, LO Power = 4 dBm

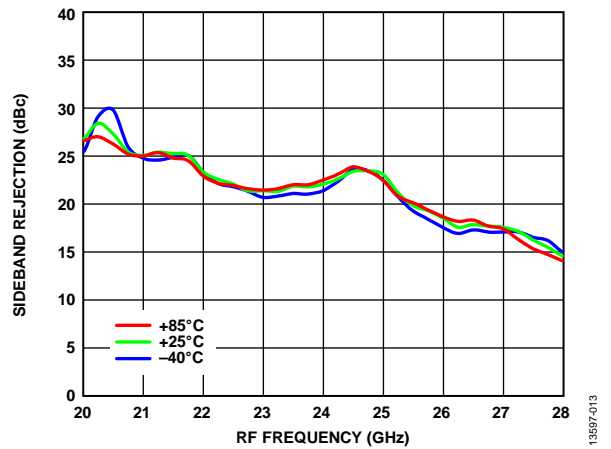

Figure 13. Sideband Rejection vs. RF Frequency over Temperature, LO Power = 4 dBm

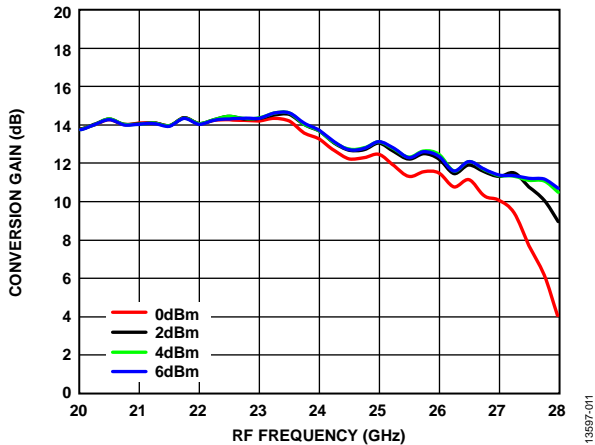

Figure 11. Conversion Gain vs. RF Frequency over LO Powers, T_A = 25°C

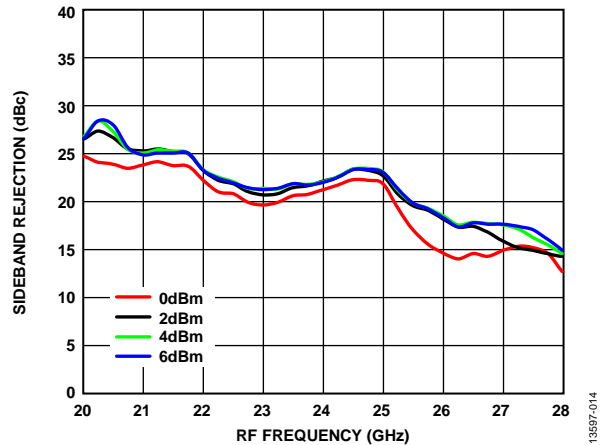

Figure 14. Sideband Rejection vs. RF Frequency over LO Powers, T_A = 25°C

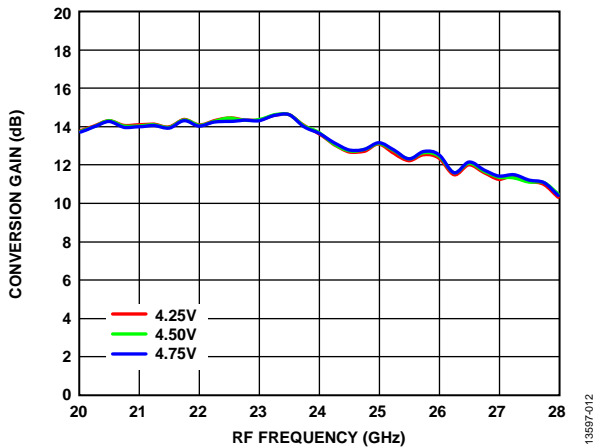

Figure 12. Conversion Gain vs. RF Frequency over VDD1, LO Power = 4 dBm, T_A = 25°C

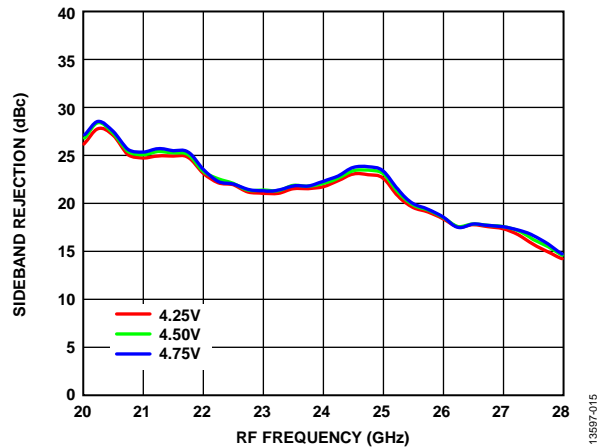

Figure 15. Sideband Rejection vs. RF Frequency over VDD1, LO Power = 4 dBm, T_A = 25°C

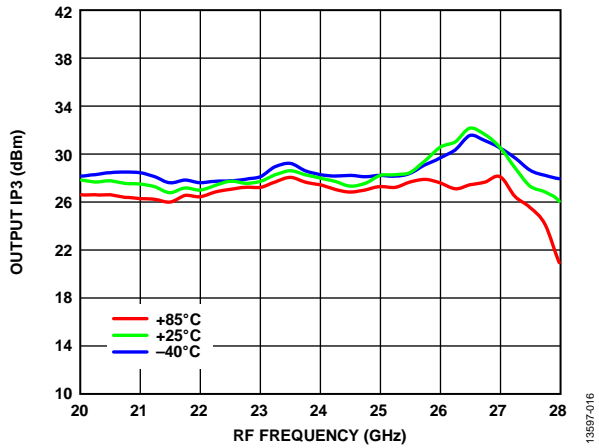

Figure 16. Output IP3 vs. RF Frequency over Temperature, LO Power = 4 dBm

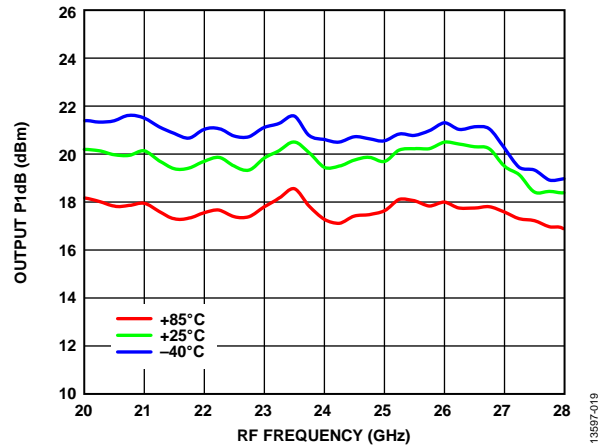

Figure 19. Output P1dB vs. RF Frequency over Temperature, LO Power = 4 dBm

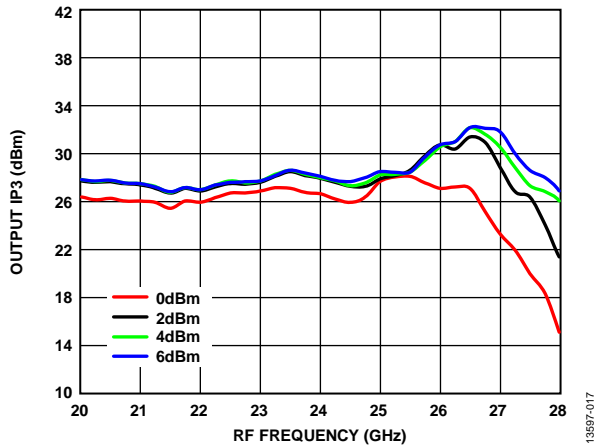

Figure 17. Output IP3 vs. RF Frequency over LO Powers, T_A = 25°C

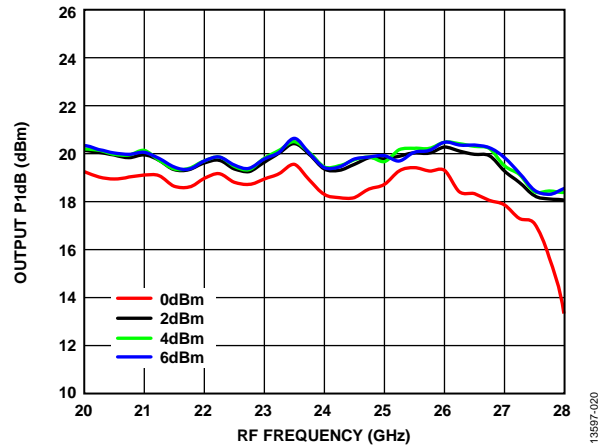

Figure 20. Output P1dB vs. RF Frequency over LO Powers, T_A = 25°C

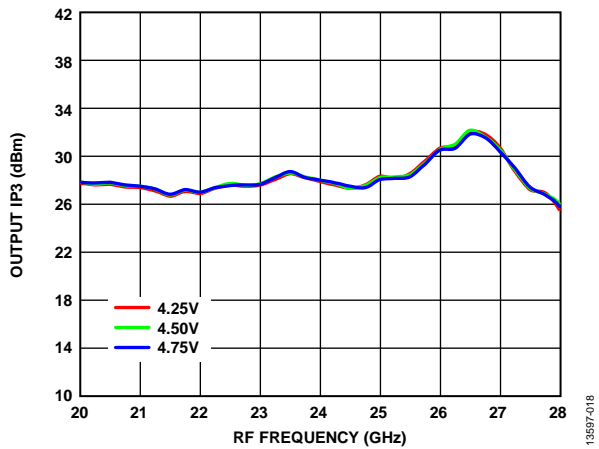

Figure 18. Output IP3 vs. RF Frequency over VDD1, T_A = 25°C

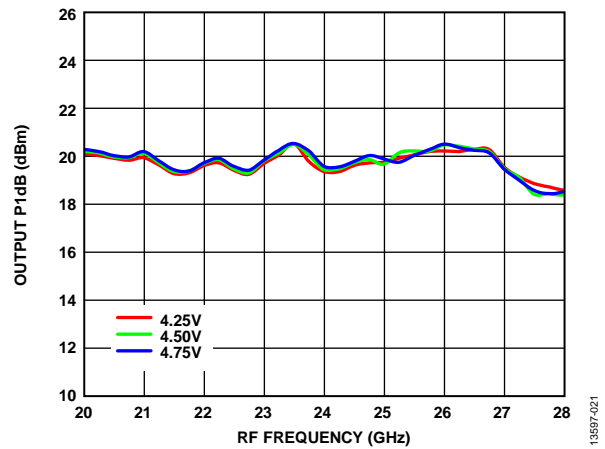

Figure 21. Output P1dB vs. RF Frequency over VDD1, T_A = 25°C

IF = 100 MHz, IF INPUT POWER = 0 dBm, LOWER SIDEBAND (HIGH-SIDE LO)

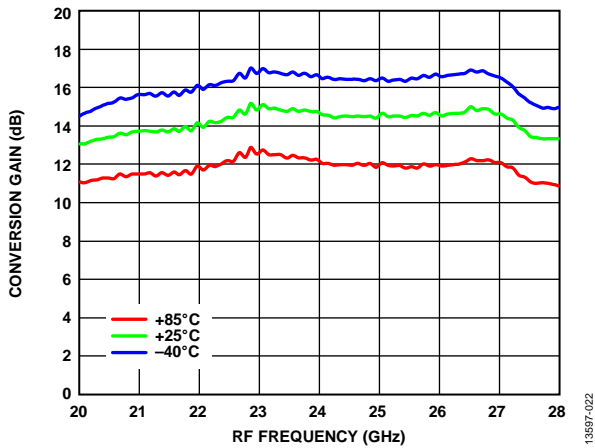

Figure 22. Conversion Gain vs. RF Frequency over Temperature, LO Power = 4 dBm

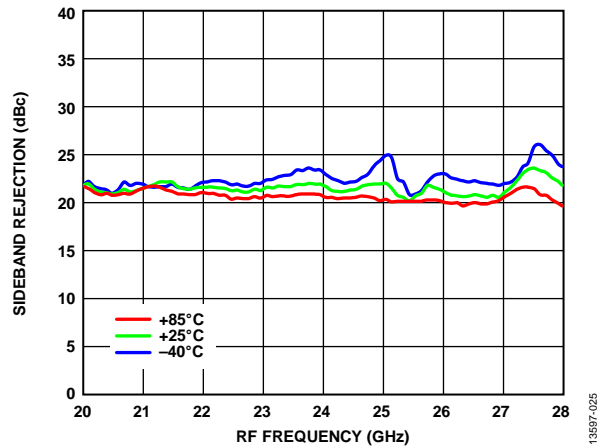

Figure 25. Sideband Rejection vs. RF Frequency over Temperature, LO Power = 4 dBm

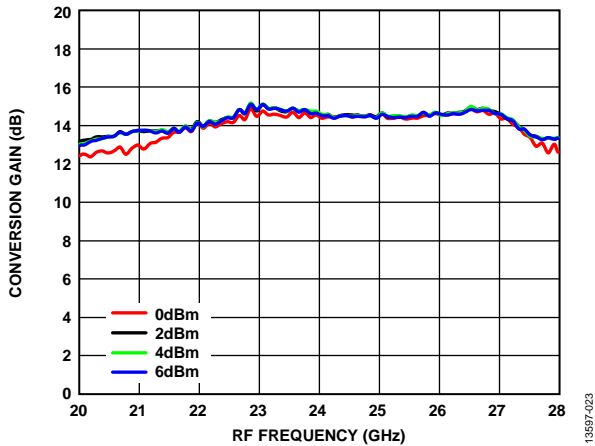

Figure 23. Conversion Gain vs. RF Frequency over LO Powers, $T_A = 25^\circ\text{C}$

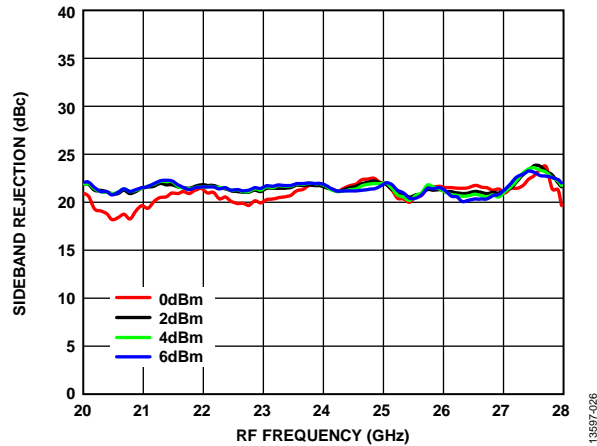

Figure 26. Sideband Rejection vs. RF Frequency over LO Powers, $T_A = 25^\circ\text{C}$

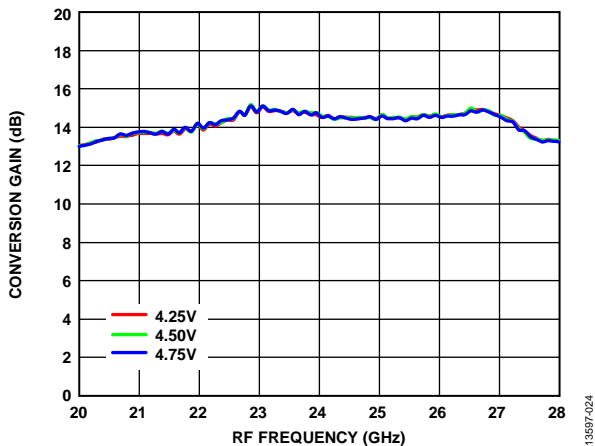

Figure 24. Conversion Gain vs. RF Frequency over VDD1, LO Power = 4 dBm, $T_A = 25^\circ\text{C}$

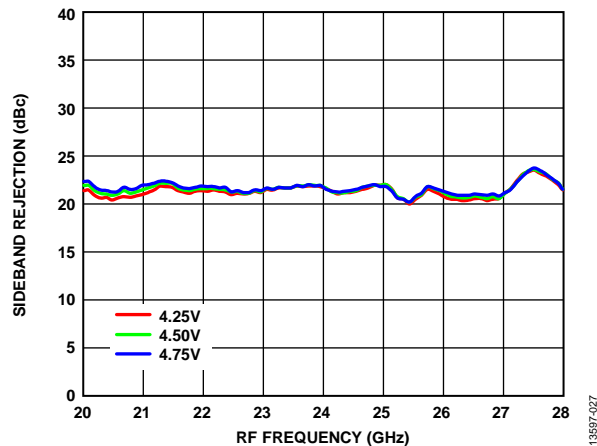

Figure 27. Sideband Rejection vs. RF Frequency over VDD1, LO Power = 4 dBm, $T_A = 25^\circ\text{C}$

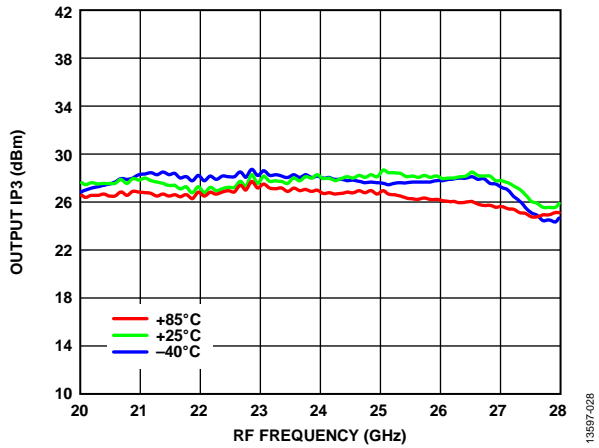

Figure 28. Output IP3 vs. RF Frequency over Temperature, LO Power = 4 dBm

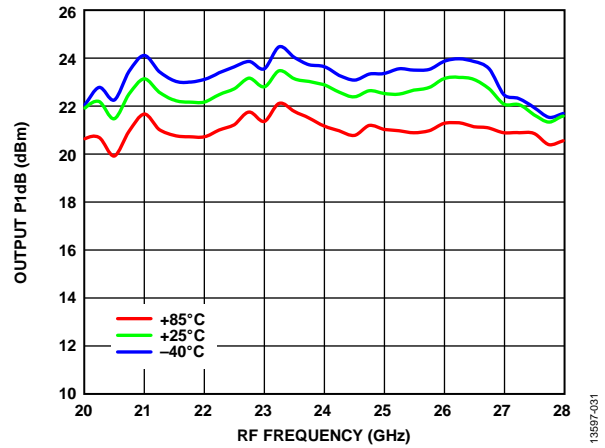

Figure 31. Output P1dB vs. RF Frequency over Temperature, LO Power = 4 dBm

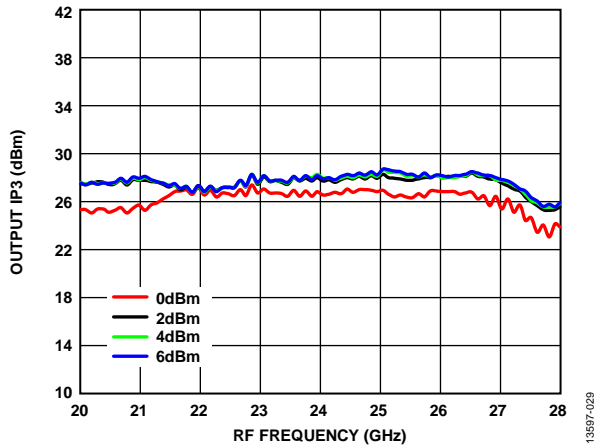

Figure 29. Output IP3 vs. RF Frequency over LO Powers, $T_A = 25^\circ\text{C}$

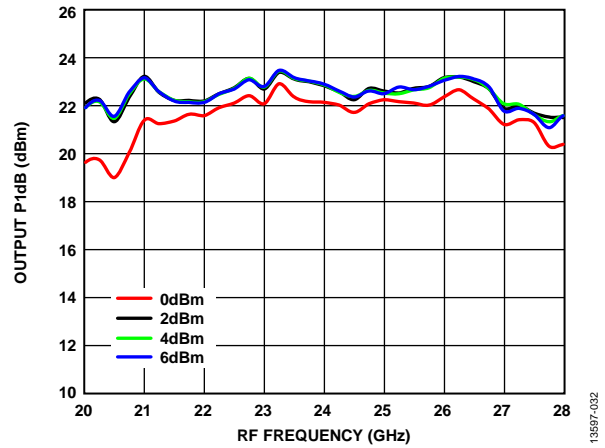

Figure 32. Output P1dB vs. RF Frequency over LO Powers, $T_A = 25^\circ\text{C}$

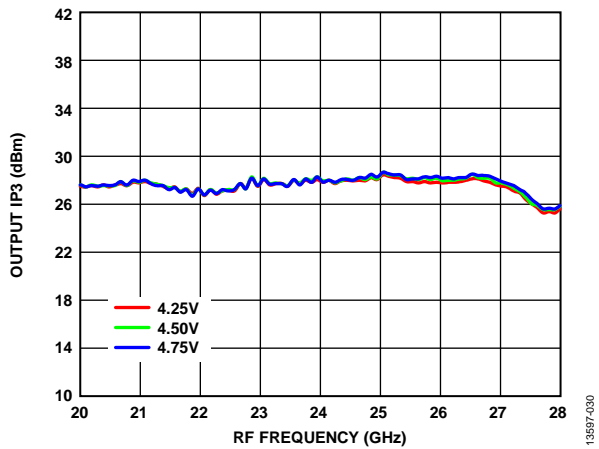

Figure 30. Output IP3 vs. RF Frequency over VDD1, LO Power = 4 dBm, $T_A = 25^\circ\text{C}$

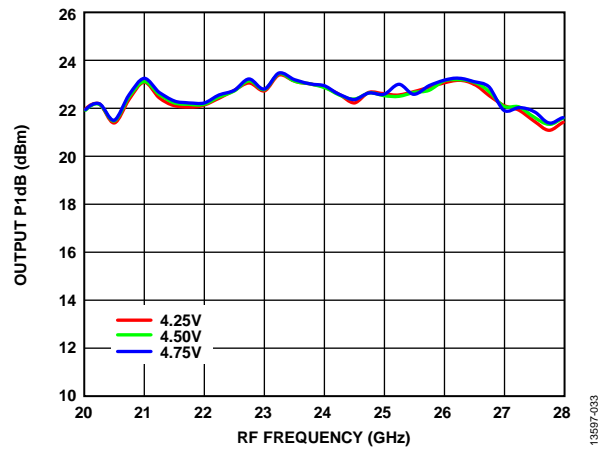

Figure 33. Output P1dB vs. RF Frequency over VDD1, LO Power = 4 dBm, $T_A = 25^\circ\text{C}$

IF = 3750 MHz, IF INPUT POWER = 0 dBm, LOWER SIDEBAND (HIGH-SIDE LO)

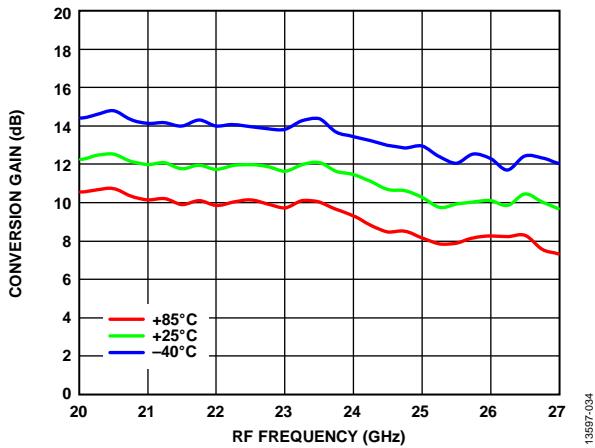

Figure 34. Conversion Gain vs. RF Frequency over Temperature, LO Power = 4 dBm

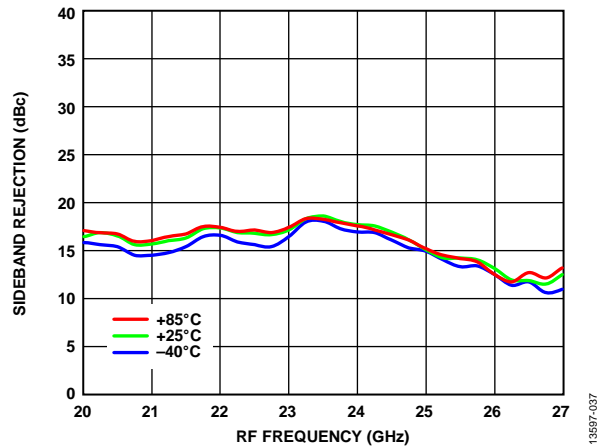

Figure 37. Sideband Rejection vs. RF Frequency over Temperature, LO Power = 4 dBm

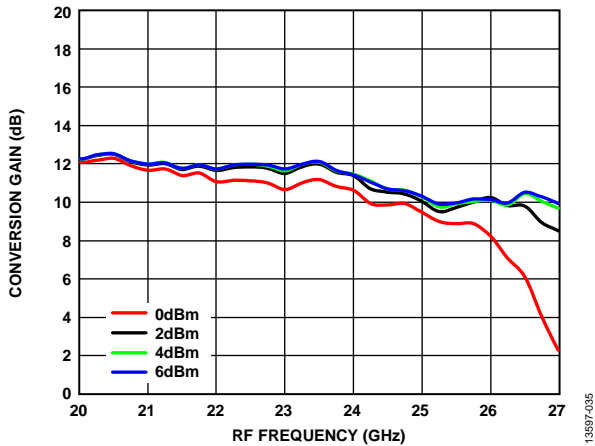

Figure 35. Conversion Gain vs. RF Frequency over LO Powers, $T_A = 25^\circ\text{C}$

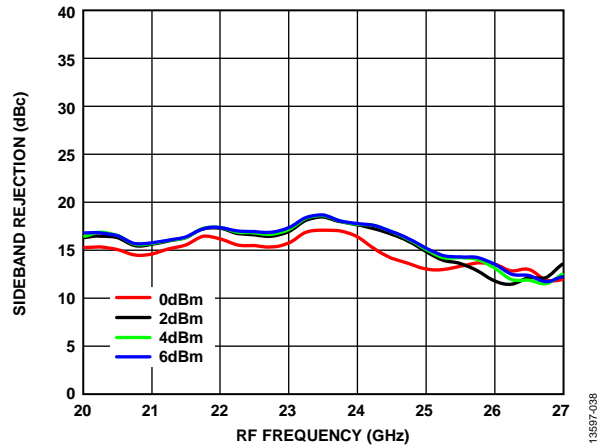

Figure 38. Sideband Rejection vs. RF Frequency over LO Powers, $T_A = 25^\circ\text{C}$

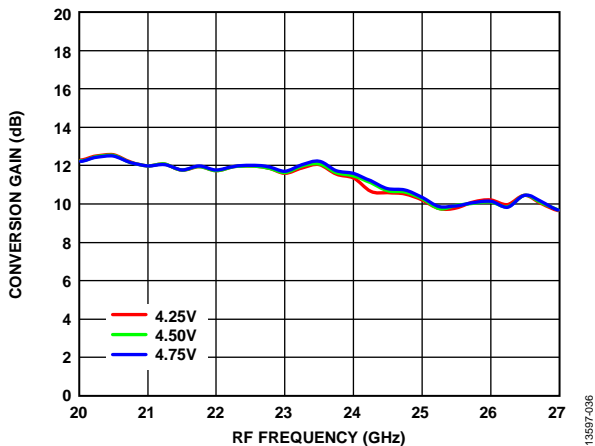

Figure 36. Conversion Gain vs. RF Frequency over VDD1, LO Power = 4 dBm, $T_A = 25^\circ\text{C}$

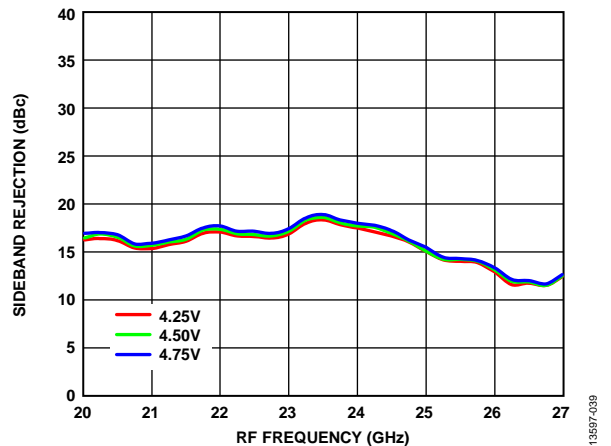

Figure 39. Sideband Rejection vs. RF Frequency over VDD1, LO Power = 4 dBm, $T_A = 25^\circ\text{C}$

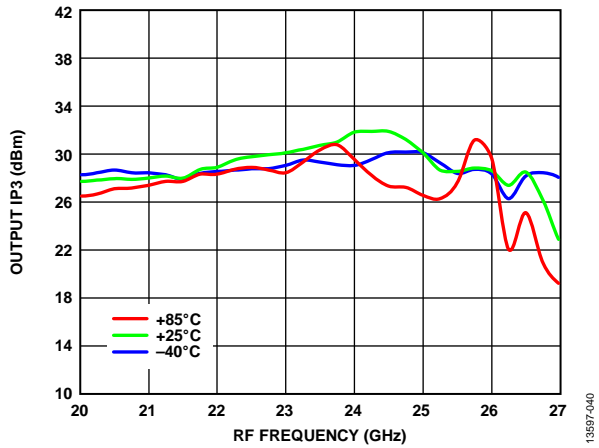

Figure 40. Output IP3 vs. RF Frequency over Temperature, LO Power = 4 dBm

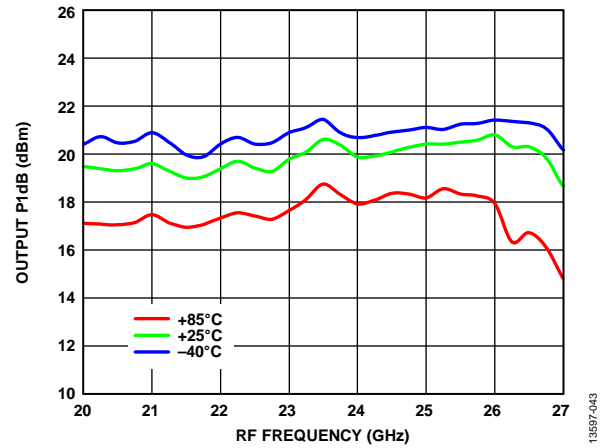

Figure 43. Output P1dB vs. RF Frequency over Temperature, LO Power = 4 dBm

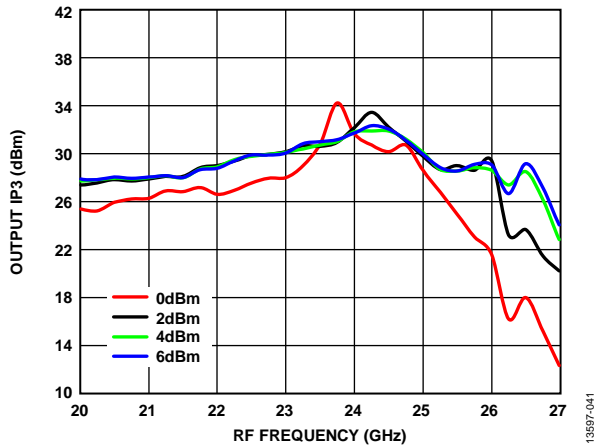

Figure 41. Output IP3 vs. RF Frequency over LO Powers, $T_A = 25^\circ\text{C}$

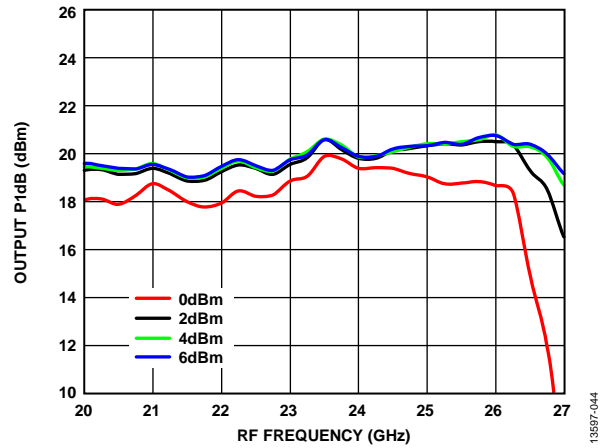

Figure 44. Output P1dB vs. RF Frequency over LO Powers, $T_A = 25^\circ\text{C}$

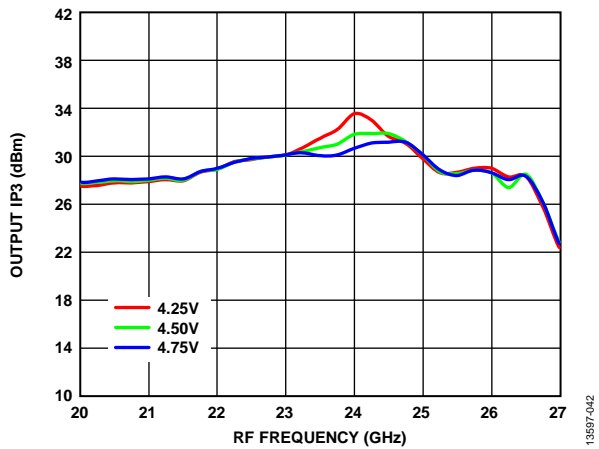

Figure 42. Output IP3 vs. RF Frequency over VDD1, LO Power = 4 dBm, $T_A = 25^\circ\text{C}$

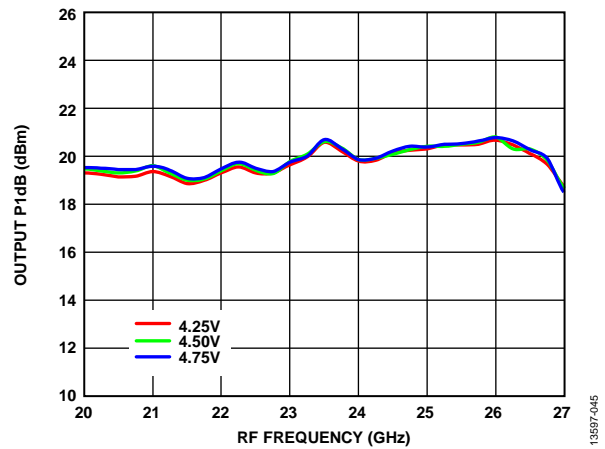

Figure 45. Output P1dB vs. RF Frequency over VDD1, LO Power = 4 dBm, $T_A = 25^\circ\text{C}$

IF = 100 MHz, IF INPUT POWER = 0 dBm, UPPER SIDEBAND (LOW-SIDE LO)

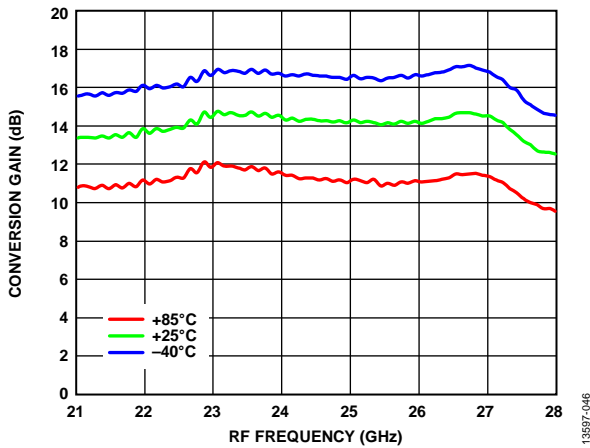

Figure 46. Conversion Gain vs. RF Frequency over Temperature, LO Power = 4 dBm

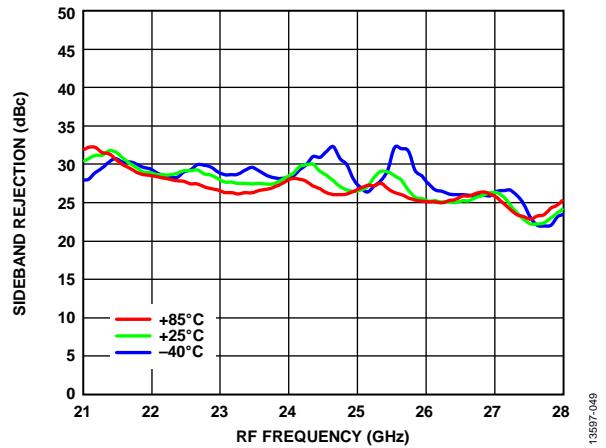

Figure 49. Sideband Rejection vs. RF Frequency over Temperature, LO Power = 4 dBm

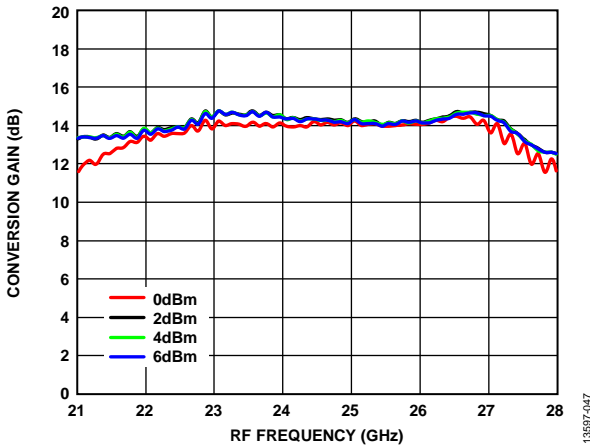

Figure 47. Conversion Gain vs. RF Frequency over LO Powers, $T_A = 25^\circ\text{C}$

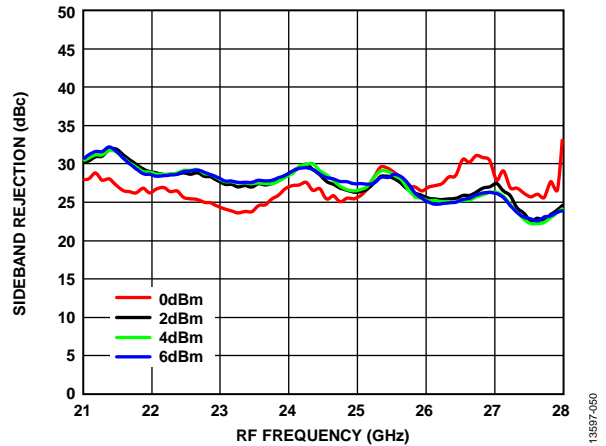

Figure 50. Sideband Rejection vs. RF Frequency over LO Powers, $T_A = 25^\circ\text{C}$

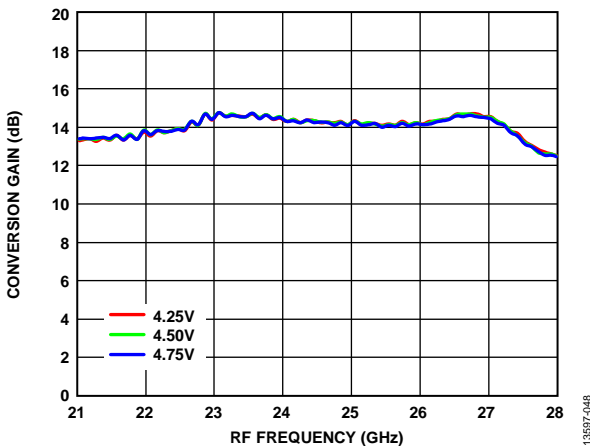

Figure 48. Conversion Gain vs. RF Frequency over VDD1, LO Power = 4 dBm, $T_A = 25^\circ\text{C}$

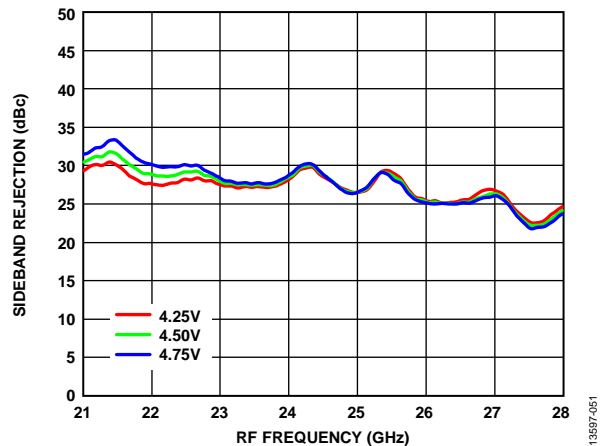

Figure 51. Sideband Rejection vs. RF Frequency over VDD1, LO Power = 4 dBm, $T_A = 25^\circ\text{C}$

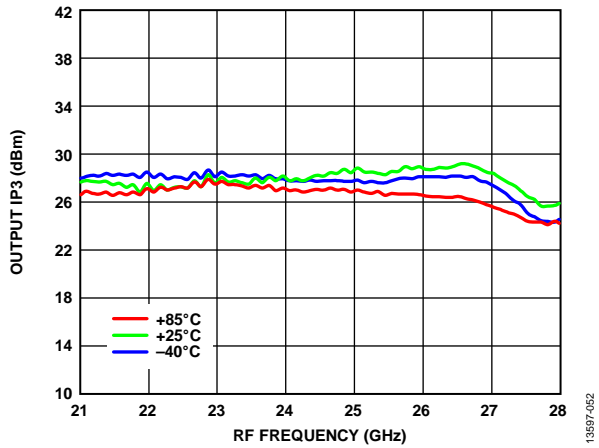

Figure 52. Output IP3 vs. RF Frequency over Temperature, LO Power = 4 dBm

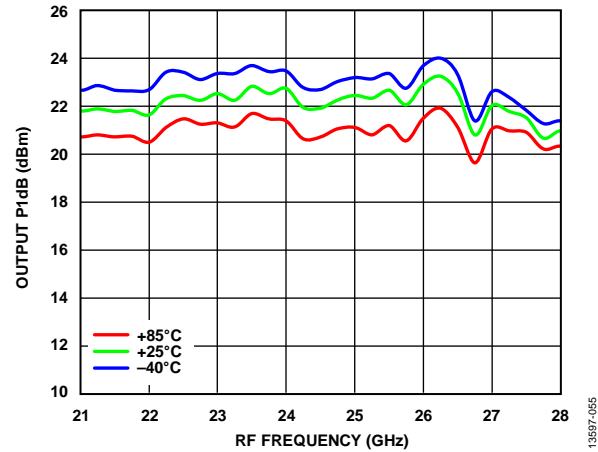

Figure 55. Output P1dB vs. RF Frequency over Temperature, LO Power = 4 dBm

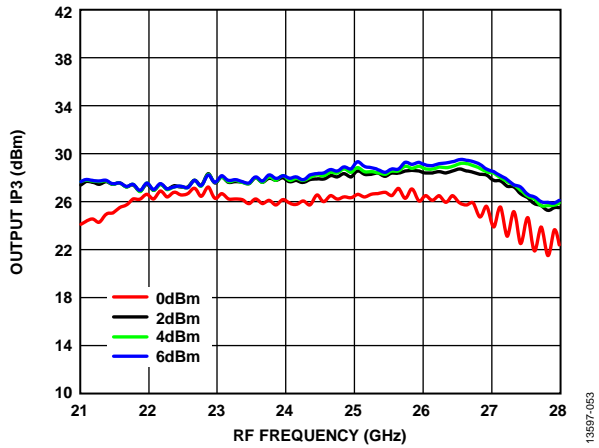

Figure 53. Output IP3 vs. RF Frequency over LO Powers, $T_A = 25^\circ\text{C}$

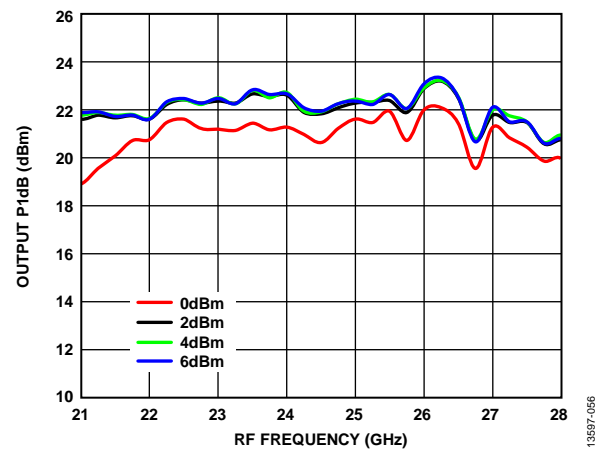

Figure 56. Output P1dB vs. RF Frequency over LO Powers, $T_A = 25^\circ\text{C}$

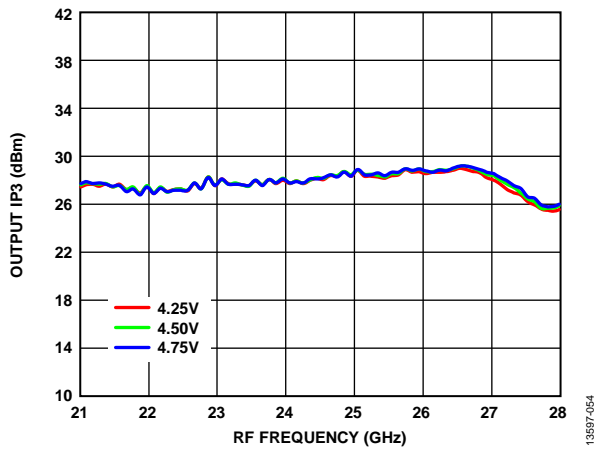

Figure 54. Output IP3 vs. RF Frequency over VDD1, LO Power = 4 dBm, $T_A = 25^\circ\text{C}$

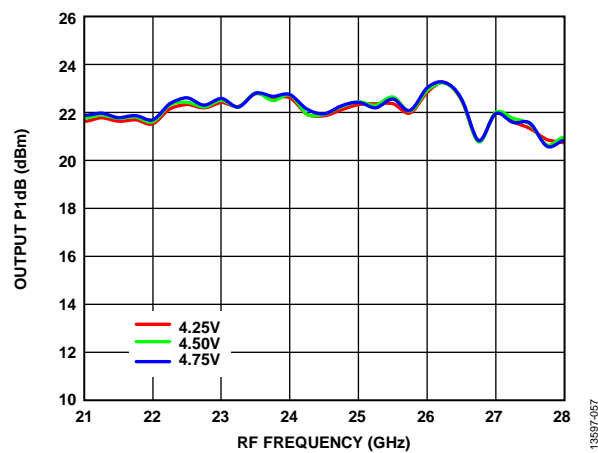

Figure 57. Output P1dB vs. RF Frequency over VDD1, LO Power = 4 dBm, $T_A = 25^\circ\text{C}$

IF = 2500 MHz, RF INPUT POWER = 0 dBm, UPPER SIDEBAND (LOW-SIDE LO)

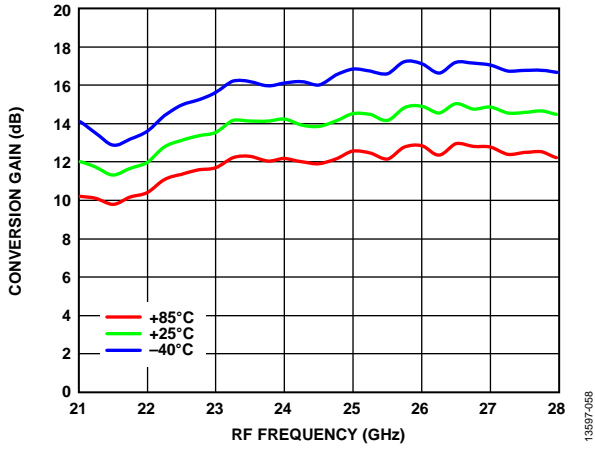

Figure 58. Conversion Gain vs. RF Frequency over Temperature, LO Power = 4 dBm

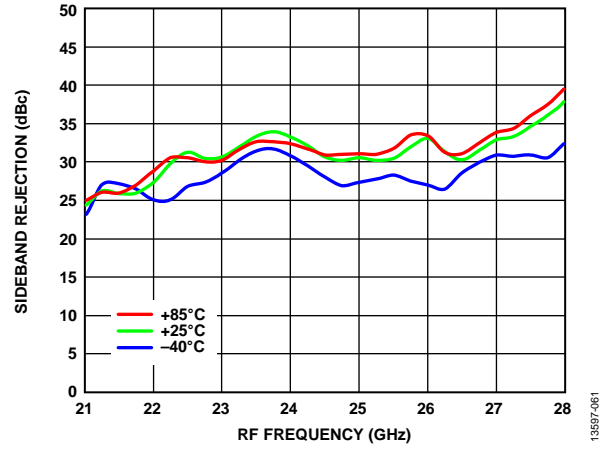

Figure 61. Sideband Rejection vs. RF Frequency over Temperature, LO Power = 4 dBm

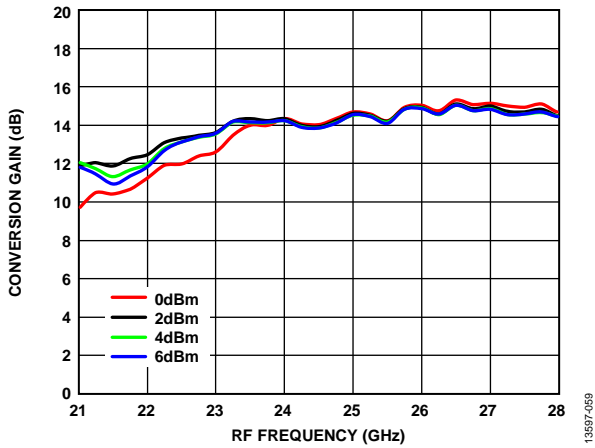

Figure 59. Conversion Gain vs. RF Frequency over LO Powers, $T_A = 25^\circ\text{C}$

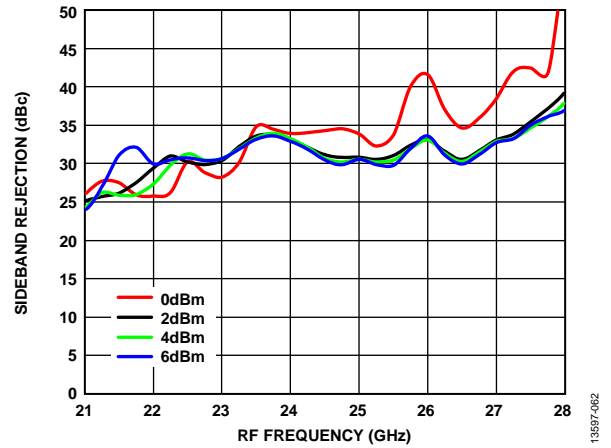

Figure 62. Sideband Rejection vs. RF Frequency over LO Powers, $T_A = 25^\circ\text{C}$

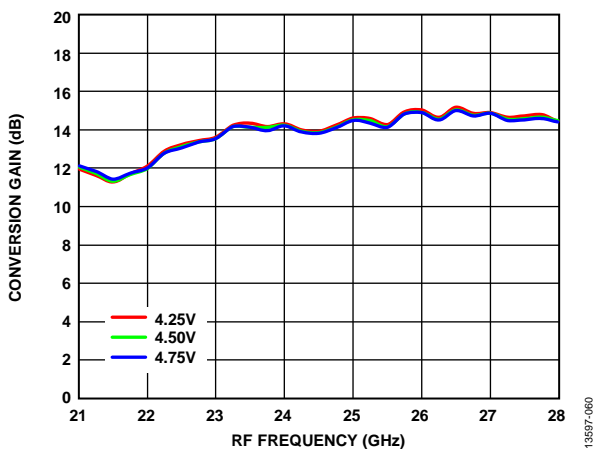

Figure 60. Conversion Gain vs. RF Frequency over VDD1, LO Power = 4 dBm, $T_A = 25^\circ\text{C}$

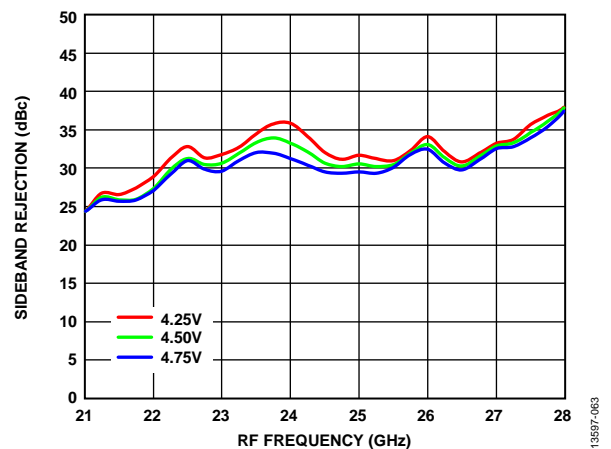

Figure 63. Sideband Rejection vs. RF Frequency over VDD1, LO Power = 4 dBm, $T_A = 25^\circ\text{C}$

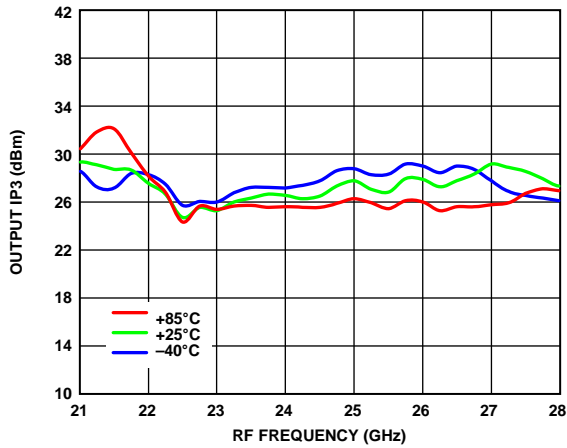

Figure 64. Output IP3 vs. RF Frequency over Temperature, LO Power = 4 dBm

13597-064

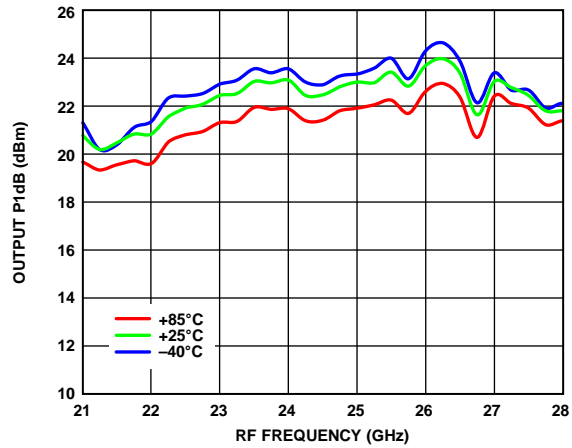

Figure 67. Output P1dB vs. RF Frequency over Temperature, LO Power = 4 dBm

13597-067

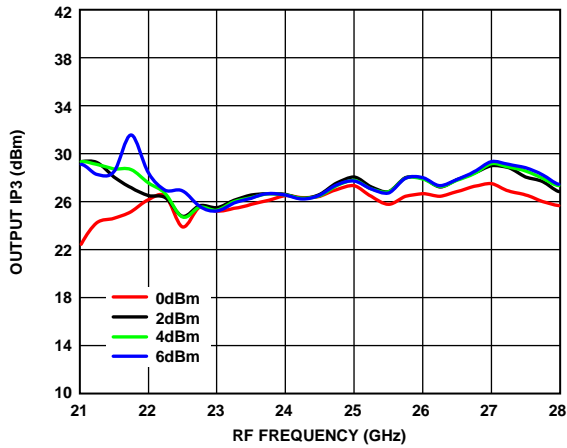

Figure 65. Output IP3 vs. RF Frequency over LO Powers, $T_A = 25^\circ\text{C}$

13597-065

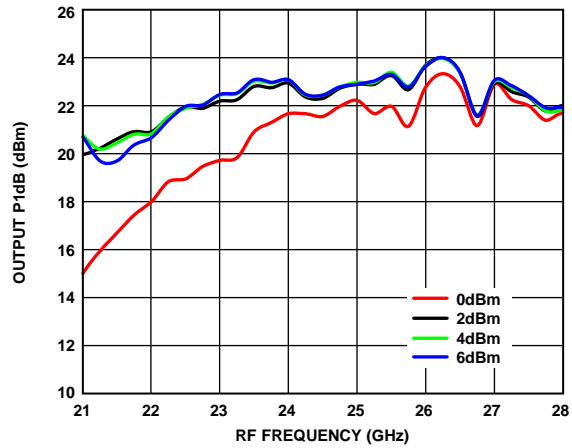

Figure 68. Output P1dB vs. RF Frequency over LO Powers, $T_A = 25^\circ\text{C}$

13597-068

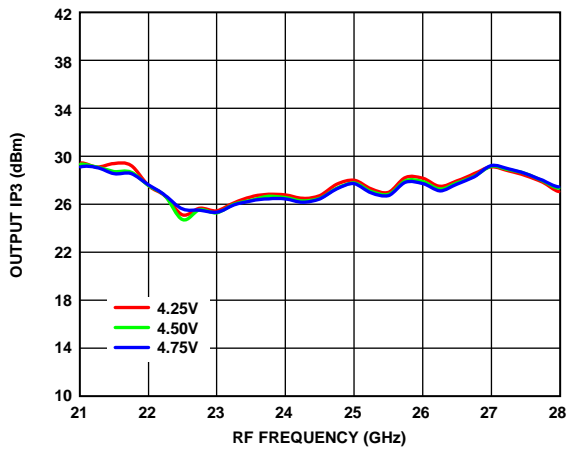

Figure 66. Output IP3 vs. RF Frequency over VDD1, LO Power = 4 dBm, $T_A = 25^\circ\text{C}$

13597-066

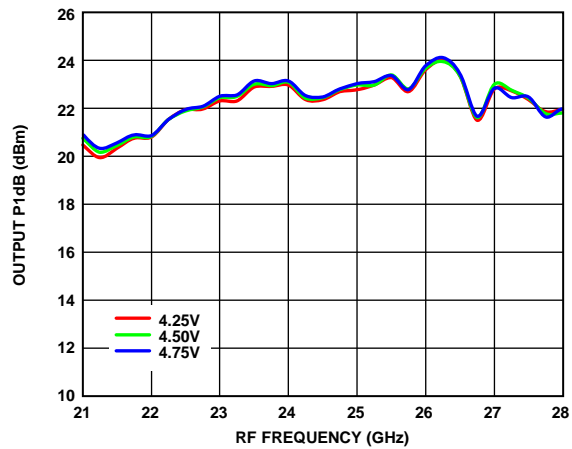

Figure 69. Output P1dB vs. RF Frequency over VDD1, LO Power = 4 dBm, $T_A = 25^\circ\text{C}$

13597-069

IF = 3750 MHz, RF INPUT POWER = 0 dBm, UPPER SIDEBAND (LOW-SIDE LO)

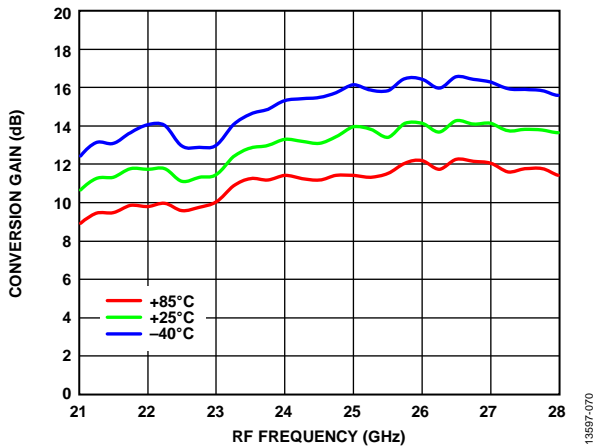

Figure 70. Conversion Gain vs. RF Frequency over Temperature, LO Power = 4 dBm

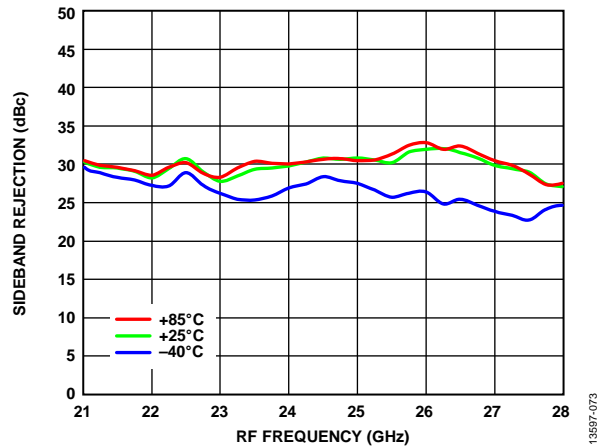

Figure 73. Sideband Rejection vs. RF Frequency over Temperature, LO Power = 4 dBm

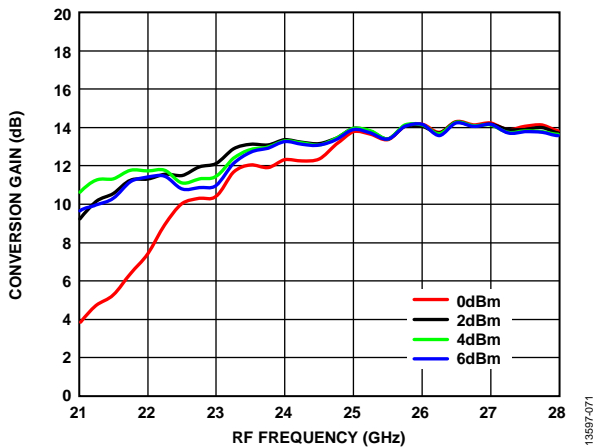

Figure 71. Conversion Gain vs. RF Frequency over LO Powers, $T_A = 25^\circ\text{C}$

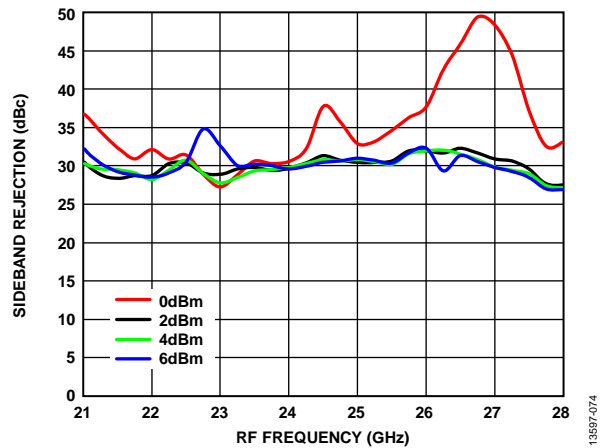

Figure 74. Sideband Rejection vs. RF Frequency over LO Powers, $T_A = 25^\circ\text{C}$

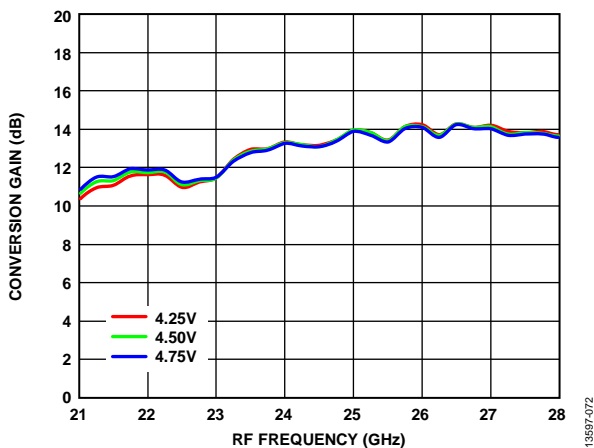

Figure 72. Conversion Gain vs. RF Frequency over VDD1, LO Power = 4 dBm, $T_A = 25^\circ\text{C}$

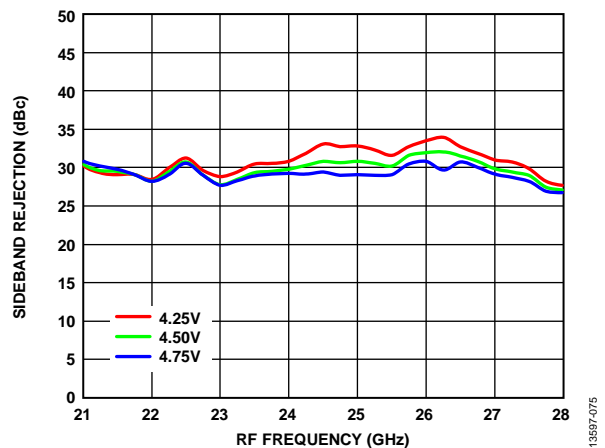

Figure 75. Sideband Rejection vs. RF Frequency over VDD1, LO Power = 4 dBm, $T_A = 25^\circ\text{C}$

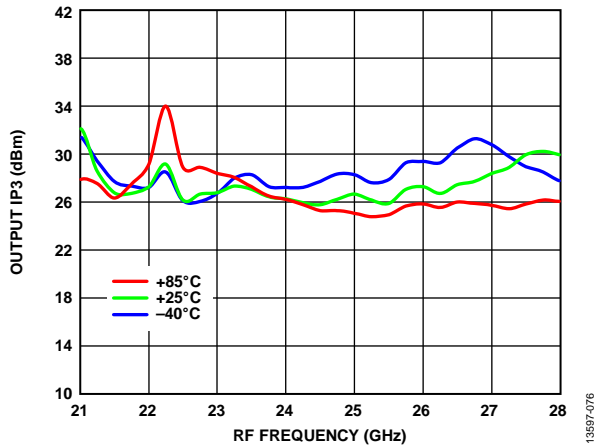

Figure 76. Output IP3 vs. RF Frequency over Temperature, LO Power = 4 dBm

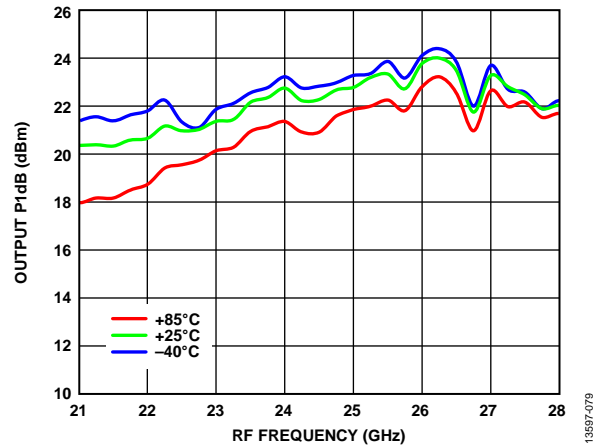

Figure 79. Output P1dB vs. RF Frequency over Temperature, LO Power = 4 dBm

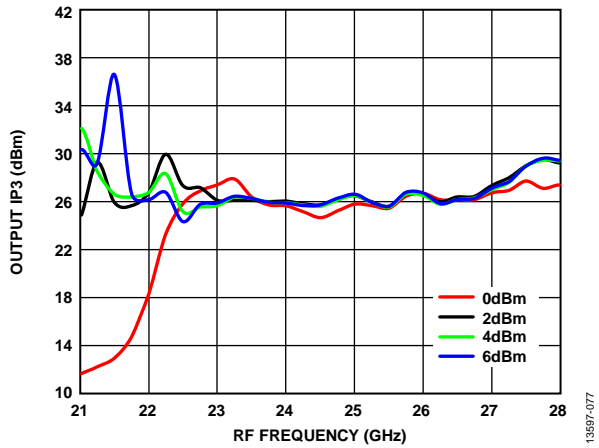

Figure 77. Output IP3 vs. RF Frequency over LO Powers, $T_A = 25^\circ\text{C}$

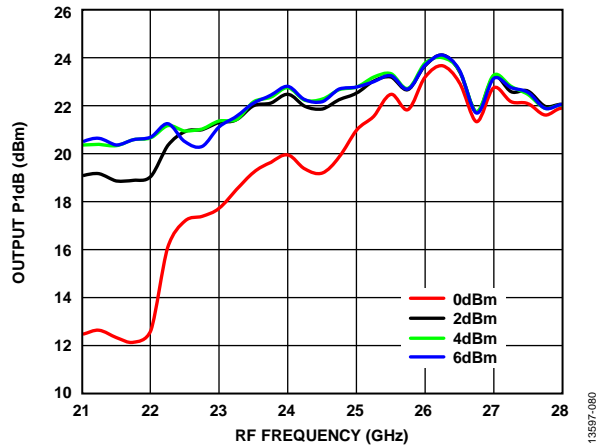

Figure 80. Output P1dB vs. RF Frequency over LO Powers, $T_A = 25^\circ\text{C}$

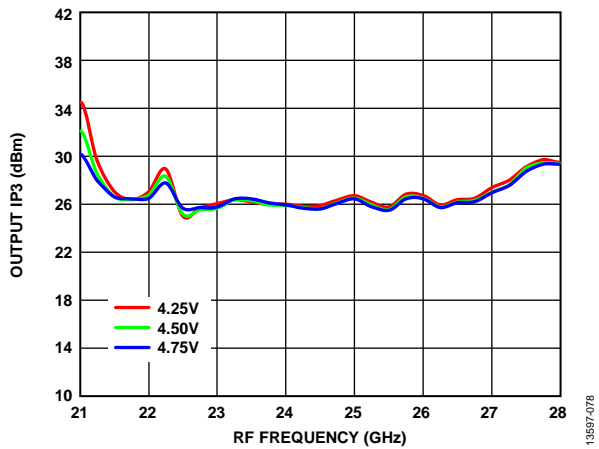

Figure 78. Output IP3 vs. RF Frequency over VDD1, LO Power = 4 dBm, $T_A = 25^\circ\text{C}$

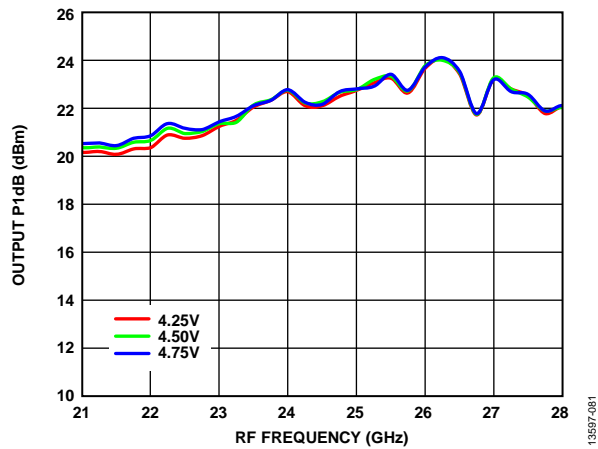

Figure 81. Output P1dB vs. RF Frequency over VDD1, LO Power = 4 dBm, $T_A = 25^\circ\text{C}$

ISOLATION AND RETURN LOSS

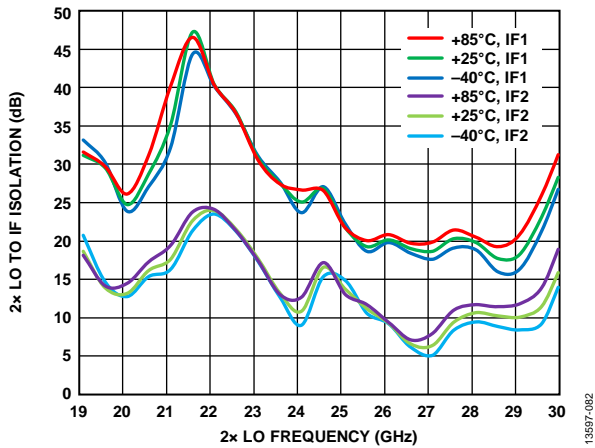

Figure 82. 2x LO to IF Isolation vs. 2x LO Frequency over Temperature, LO Power = 4 dBm

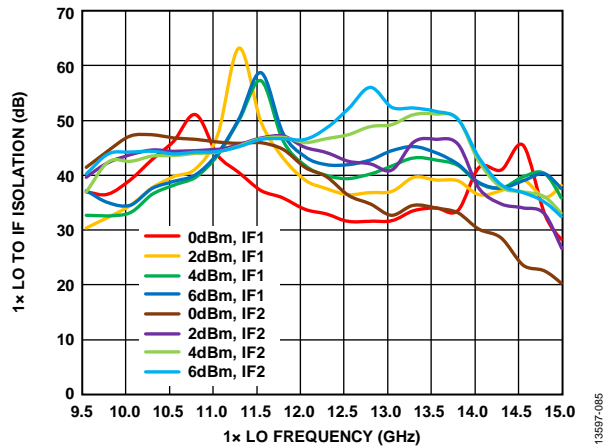

Figure 85. 1x LO to IF Isolation vs. 1x LO Frequency over LO Powers, $T_A = 25^\circ\text{C}$

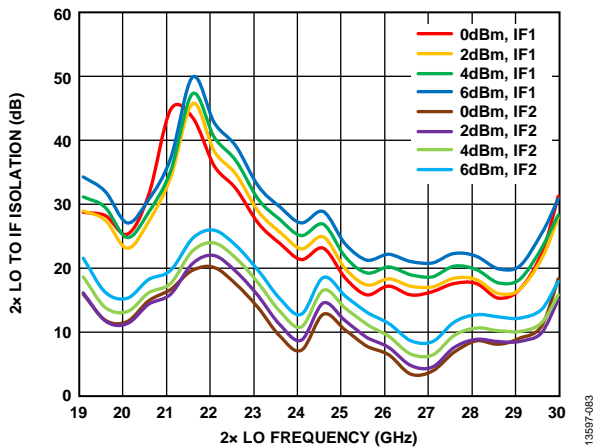

Figure 83. 2x LO to IF Isolation vs. 2x LO Frequency over LO Powers, $T_A = 25^\circ\text{C}$

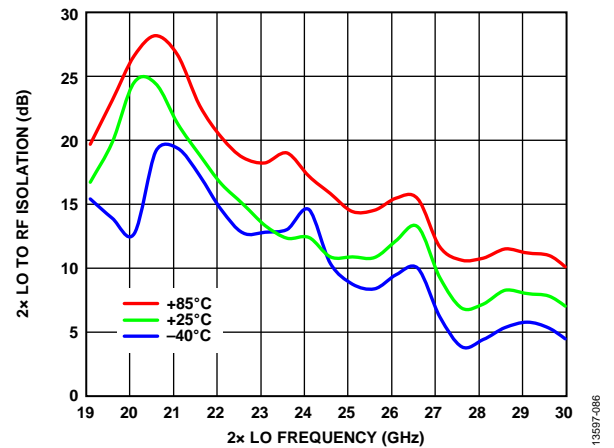

Figure 86. 2x LO to RF Isolation vs. 2x LO Frequency over Temperature, LO Power = 4 dBm

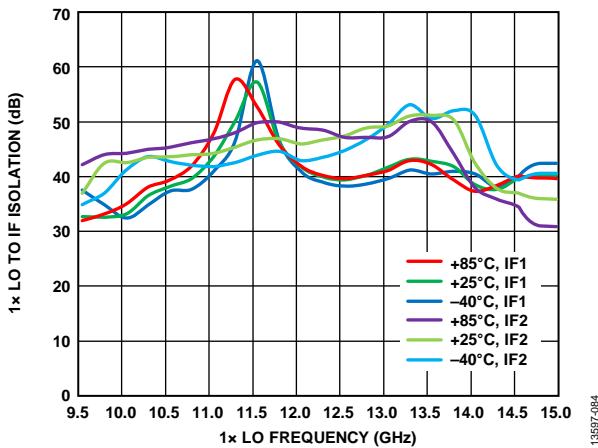

Figure 84. 1x LO to IF Isolation vs. 1x LO Frequency over Temperature, LO Power = 4 dBm

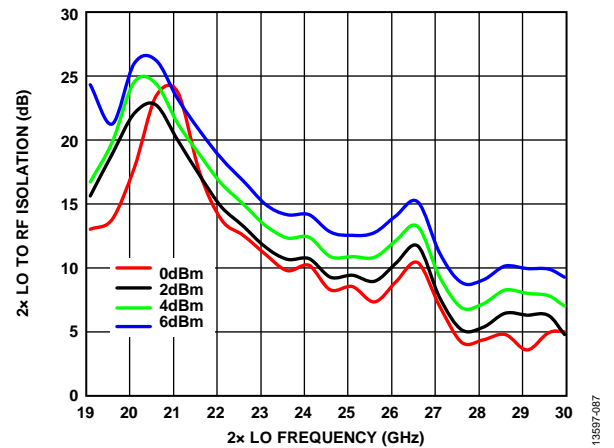

Figure 87. 2x LO to RF Isolation vs. 2x LO Frequency over LO Powers, $T_A = 25^\circ\text{C}$

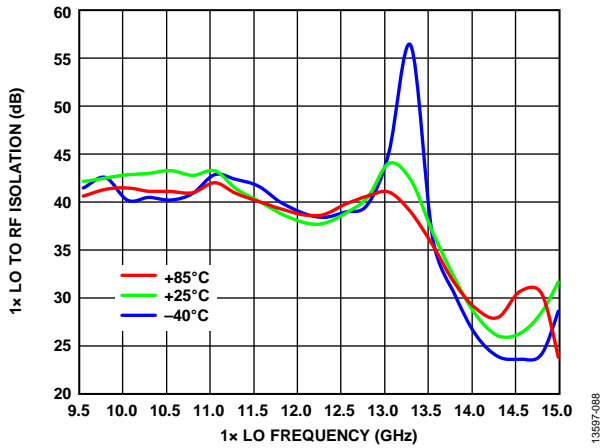

Figure 88. 1x LO to RF Isolation vs. 1x LO Frequency over Temperature, LO Power = 4 dBm

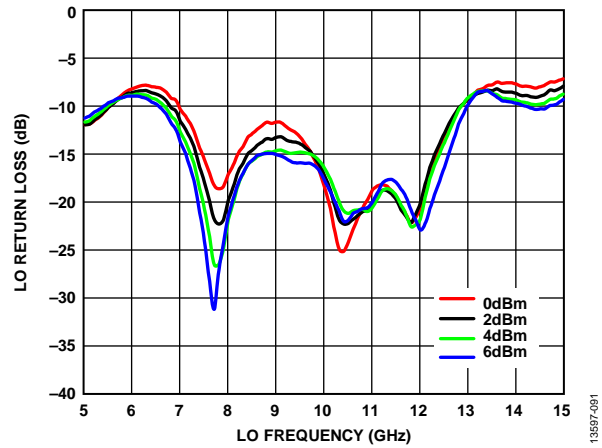

Figure 91. LO Return Loss vs. LO Frequency over LO Powers, T_A = 25°C

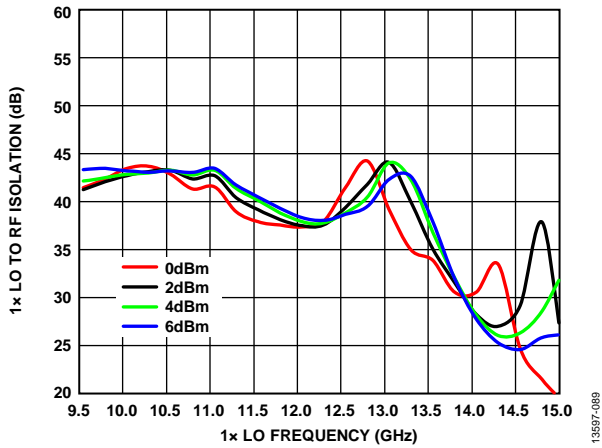

Figure 89. 1x LO to RF Isolation vs. 1x LO Frequency over LO Powers, T_A = 25°C

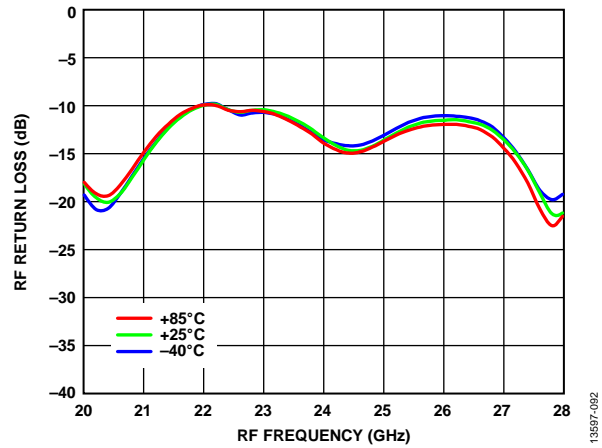

Figure 92. RF Return Loss vs. RF Frequency over Temperature, LO Frequency = 12 GHz, LO Power = 4 dBm

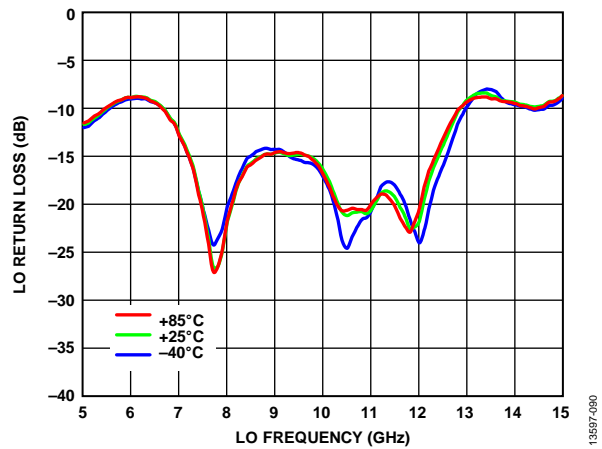

Figure 90. LO Return Loss vs. LO Frequency over Temperature, LO Power = 4 dBm

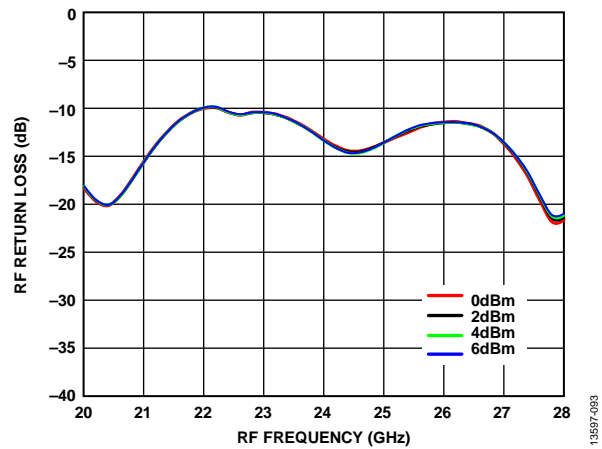

Figure 93. RF Return Loss vs. RF Frequency over LO Powers, LO Frequency = 12 GHz, T_A = 25°C

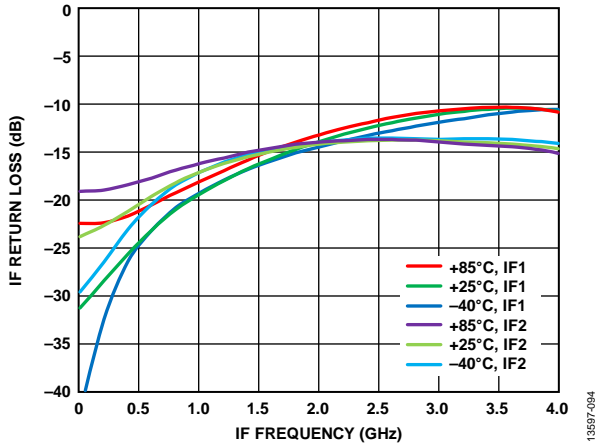

Figure 94. IF Return Loss vs. IF Frequency over Temperature, LO Frequency = 12 GHz, LO Power = 4 dBm

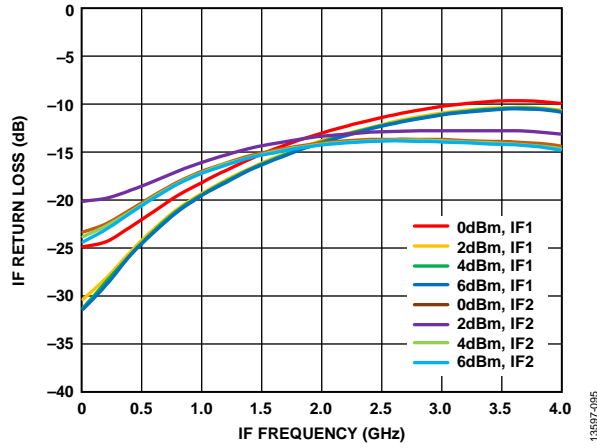

Figure 95. IF Return Loss vs. IF Frequency over LO Powers, LO Frequency = 12 GHz, $T_A = 25^\circ\text{C}$

IF BANDWIDTH PERFORMANCE: LOWER SIDEBAND (HIGH-SIDE LO)

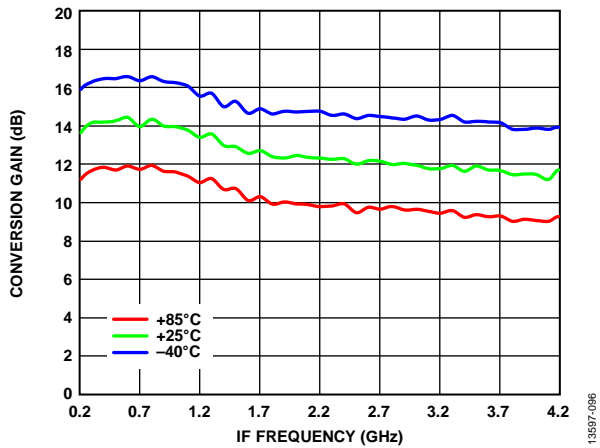

Figure 96. Conversion Gain vs. IF Frequency over Temperature, LO Frequency = 12 GHz, LO Power = 4 dBm

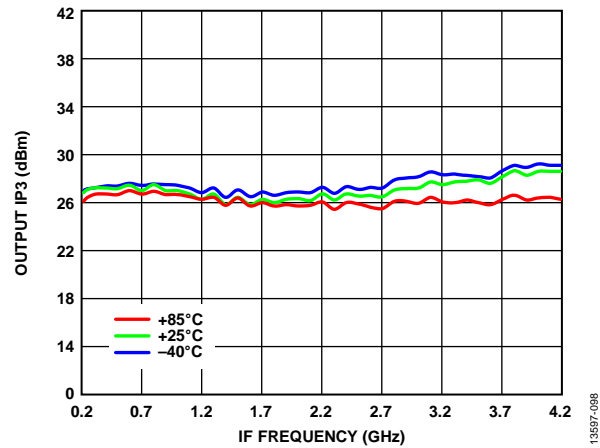

Figure 98. Output IP3 vs. IF Frequency over Temperature, LO Frequency = 12 GHz, LO Power = 4 dBm

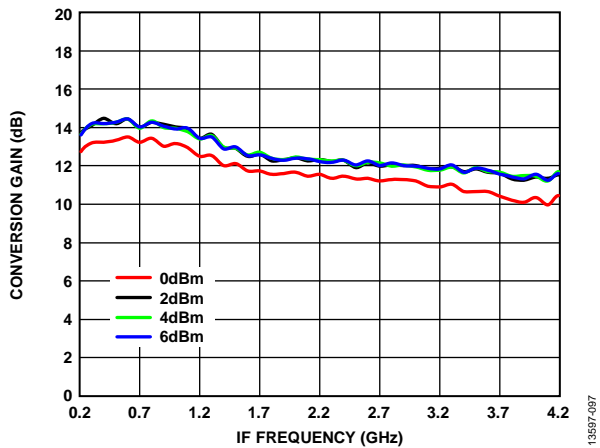

Figure 97. Conversion Gain vs. IF Frequency over LO Powers, LO Frequency = 12 GHz, T_A = 25°C

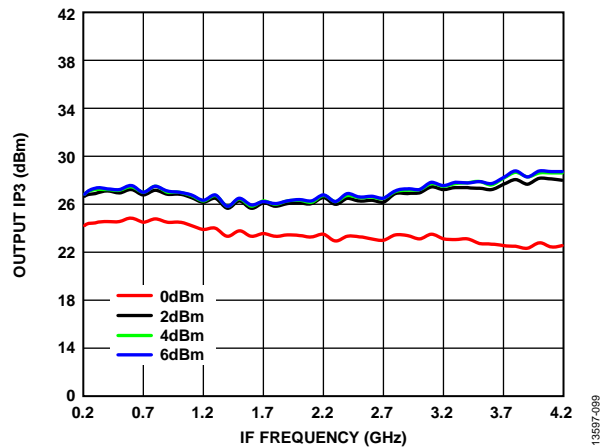

Figure 99. Output IP3 vs. IF Frequency over LO Powers, LO Frequency = 24 GHz, T_A = 25°C

IF BANDWIDTH PERFORMANCE: UPPER SIDEBAND (LOW-SIDE LO)

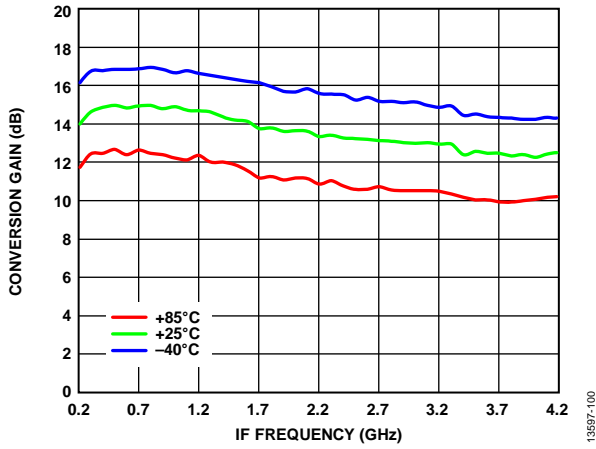

Figure 100. Conversion Gain vs. IF Frequency over Temperature, LO Frequency = 12 GHz, LO Power = 4 dBm

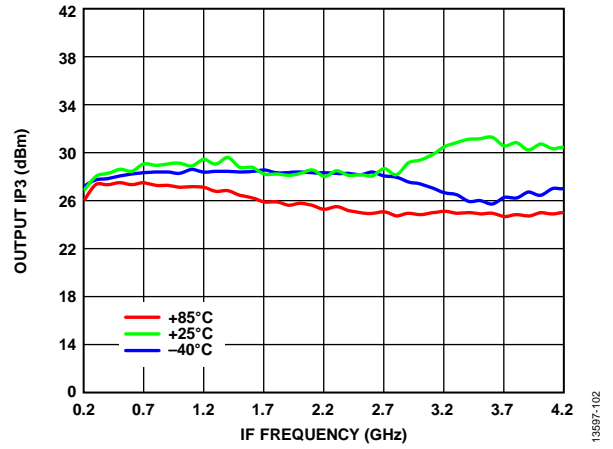

Figure 102. Output IP3 vs. IF Frequency over LO Powers, LO Frequency = 12 GHz, T_A = 25°C

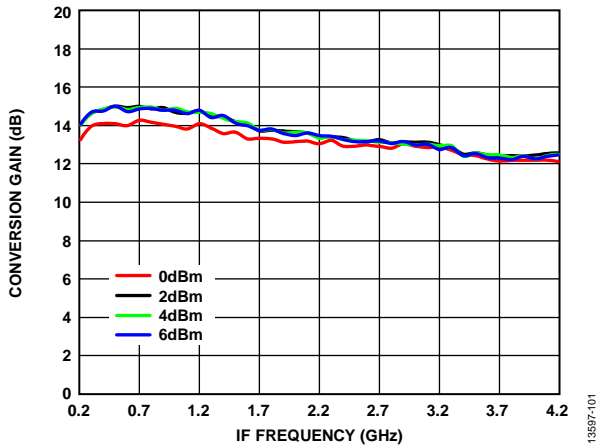

Figure 101. Conversion Gain vs. IF Frequency over Temperature, LO Frequency = 12 GHz, LO Power = 4 dBm

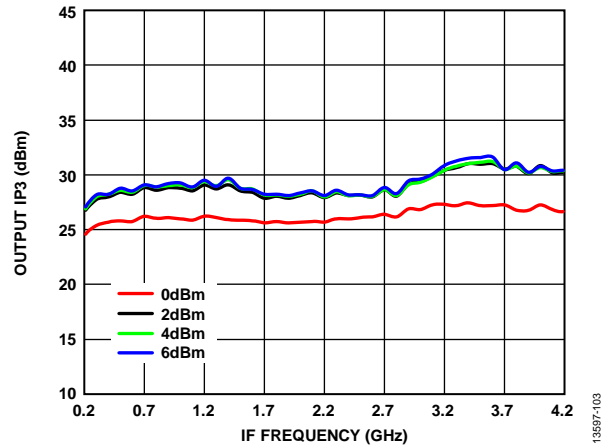

Figure 103. Output IP3 vs. IF Frequency over LO Powers, LO Frequency = 12 GHz, T_A = 25°C

SPURIOUS PERFORMANCE

M × N Spurious Outputs, IF = 2500 MHz

Mixer spurious products are measured in dBc from the RF output power level with lower sideband selected and without external 90° hybrid at the IF ports. N/A means not applicable.

RF = 21 GHz, LO frequency = 11.75 GHz at LO input power = 4 dBm, IF input power = -10 dBm.

		N × LO			
		0	1	2	3
M × IF	-3	88	104	58	75
	-2	62	92	49	75
	-1	76	67	0	41
	0	N/A	34	8	19
	+1	76	44	N/A	42
	+2	63	57	59	N/A
	+3	89	79	52	N/A

RF = 22 GHz, LO frequency = 12.25 GHz at LO input power = 4 dBm, IF input power = -10 dBm.

		N × LO			
		0	1	2	3
M × IF	-3	87	100	58	86
	-2	62	91	43	61
	-1	75	67	0	44
	0	N/A	33	4	18
	+1	75	43	N/A	49
	+2	62	60	45	N/A
	+3	76	78	50	N/A

RF = 23 GHz, LO frequency = 12.75 GHz at LO input power = 4 dBm, IF input power = -10 dBm.

		N × LO			
		0	1	2	3
M × IF	-3	88	101	62	83
	-2	61	97	43	62
	-1	79	76	0	57
	0	N/A	34	3	29
	+1	78	47	N/A	N/A
	+2	61	67	51	N/A
	+3	88	79	48	N/A

RF = 24 GHz, LO frequency = 13.25 GHz at LO input power = 4 dBm, IF input power = -10 dBm.

		N × LO			
		0	1	2	3
M × IF	-3	98	104	56	77
	-2	63	86	46	61
	-1	91	70	0	48
	0	N/A	0	4	N/A
	+1	91	36	N/A	N/A
	+2	63	57	54	N/A
	+3	97	80	55	N/A

RF = 25 GHz, LO frequency = 13.75 GHz at LO input power = 4 dBm, IF input power = -10 dBm.

		N × LO			
		0	1	2	3
M × IF	-3	85	101	49	73
	-2	63	87	37	54
	-1	73	65	0	48
	0	N/A	26	0	N/A
	+1	73	36	N/A	N/A
	+2	63	56	39	N/A
	+3	75	67	57	N/A

RF = 26 GHz, LO frequency = 14.25 GHz at LO input power = 4 dBm, IF input power = -10 dBm.

		N × LO			
		0	1	2	3
M × IF	-3	+85	+96	+49	+61
	-2	+63	+80	+44	+56
	-1	+74	+62	0	+213
	0	N/A	+20	-2	N/A
	+1	+74	+26	N/A	N/A
	+2	+63	+59	+35	N/A
	+3	+74	+56	+62	N/A

RF = 27 GHz, LO frequency = 14.75 GHz at LO input power = 4 dBm, IF input power = -10 dBm.

		N × LO			
		0	1	2	3
M × IF	-3	82	95	46	N/A
	-2	62	77	39	54
	-1	70	50	0	N/A
	0	N/A	26	1	N/A
	+1	70	22	N/A	N/A
	+2	62	34	51	N/A
	+3	73	51	48	N/A

M × N Spurious Outputs, IF = 2500 MHz

Mixer spurious products are measured in dBc from the RF output power level with upper sideband selected and without external 90° hybrid at the IF ports. N/A means not applicable.

RF = 24 GHz, LO frequency = 10.75 GHz at LO input power = 4 dBm, IF input power = -10 dBm.

		N × LO			
		0	1	2	3
M × IF	-3	95	108	65	61
	-2	60	83	52	47
	-1	79	69	N/A	29
	0	N/A	39	14	17
	+1	79	40	0	27
	+2	61	49	49	53
	+3	93	68	53	71

RF = 24.5 GHz, LO frequency = 11 GHz at LO input power = 4 dBm, IF input power = -10 dBm.

		N × LO			
		0	1	2	3
M × IF	-3	82	107	64	65
	-2	60	84	47	44
	-1	77	69	N/A	30
	0	N/A	37	11	18
	+1	77	39	0	30
	+2	60	47	50	52
	+3	94	72	52	N/A

RF = 25 GHz, LO frequency = 11.25 GHz at LO input power = 4 dBm, IF input power = -10 dBm.

		N × LO			
		0	1	2	3
M × IF	-3	84	109	62	63
	-2	60	89	57	52
	-1	76	70	N/A	33
	0	N/A	38	11	19
	+1	76	41	0	35
	+2	60	51	47	58
	+3	97	70	51	N/A

RF = 25.5 GHz, LO frequency = 11.5 GHz at LO input power = 4 dBm, IF input power = -10 dBm.

		N × LO			
		0	1	2	3
M × IF	-3	90	109	60	82
	-2	60	91	42	54
	-1	74	69	N/A	39
	0	N/A	0	9	18
	+1	74	41	0	39
	+2	60	50	42	68
	+3	90	81	52	N/A

RF = 26 GHz, LO frequency = 11.75 GHz at LO input power = 4 dBm, IF input power = -10 dBm.

		N × LO			
		0	1	2	3
M × IF	-3	85	105	58	75
	-2	60	94	48	56
	-1	72	65	N/A	43
	0	N/A	33	7	18
	+1	72	42	0	35
	+2	60	60	45	58
	+3	86	75	51	N/A

RF = 26.5 GHz, LO frequency = 12 GHz at LO input power = 4 dBm, IF input power = -10 dBm.

		N × LO			
		0	1	2	3
M × IF	-3	84	106	52	75
	-2	60	98	46	57
	-1	70	64	N/A	47
	0	N/A	32	6	18
	+1	70	47	0	54
	+2	59	74	47	N/A
	+3	83	75	51	N/A

RF = 27 GHz, LO frequency = 12.25 GHz at LO input power = 4 dBm, IF input power = -10 dBm.

		N × LO			
		0	1	2	3
M × IF	-3	82	103	52	N/A
	-2	59	100	37	56
	-1	69	65	N/A	46
	0	N/A	33	5	19
	+1	69	58	0	51
	+2	59	73	47	N/A
	+3	82	76	51	N/A

THEORY OF OPERATION

The HMC815B is a GaAs, pHEMT, MMIC I/Q upconverter with an integrated LO buffer that upconverts IF between dc and 3.75 GHz to RF between 21 GHz and 27 GHz. LO buffer amplifiers are included on chip to allow an LO drive range from 0 dBm to 6 dBm for full performance. The LO path feeds a quadrature splitter followed by on-chip baluns that drive the I and Q singly balanced cores of the passive mixers. The RF

output of the I and Q mixers are then summed through an on-chip Wilkinson power combiner and relatively matched to provide a single-ended, 50 Ω output signal that is amplified by the RF amplifiers to produce a dc-coupled and 50 Ω matched RF output signal at the RFOUT port.

APPLICATIONS INFORMATION

TYPICAL APPLICATION CIRCUIT

Figure 104 shows the typical application circuit for the HMC815B. To select the appropriate sideband, an external 90° hybrid is required. For applications not requiring operation to dc, use an off chip, dc blocking capacitor. For applications that require the LO signal at the output to be suppressed, use a bias tee or RF feed. Ensure that the source or sink current used for

LO suppression is <3 mA for each IF port to prevent damage to the device. The common-mode voltage for each IF port is 0 V.

To select the upper sideband, connect the IF1 pin to the 90° port of the hybrid and the IF2 pin to the 0° port of the hybrid. To select the lower sideband, connect the IF1 pin to the 0° port of the hybrid and the IF2 pin to the 90° port of the hybrid.

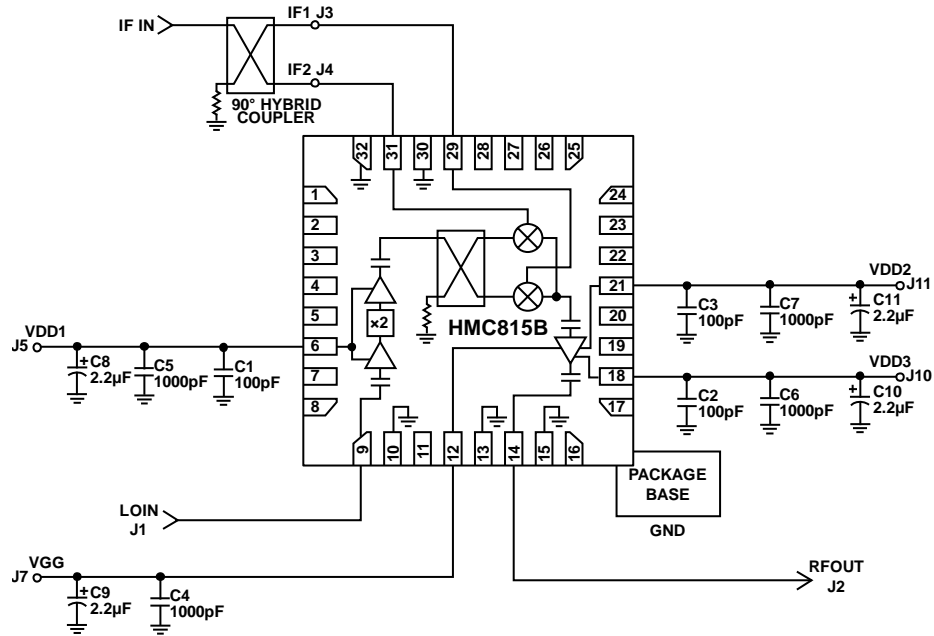

Figure 104. Typical Application Circuit

13597-104

EVALUATION BOARD INFORMATION

The circuit board used in the application must use RF circuit design techniques. Signal lines must have 50 Ω impedance. Connect the package ground leads and exposed pad directly to the ground plane, as shown in Figure 105. Use a sufficient number of via holes to connect the top and bottom ground planes. The evaluation circuit board shown in Figure 107 is available from Analog Devices upon request.

EV1HMC815BLC5 Power-On Sequence

To set up the EV1HMC815BLC5, take the following steps:

1. Power up VGG with a -2 V supply.
2. Power up VDD2 and VDD3 with a 4.5 V supply.
3. Power up VDD1 with another 4.5 V supply.
4. Adjust the VGG supply between -2 V and 0 V until the total RF supply current ($I_{DD2} + I_{DD3}$) = 270 mA.
5. Connect LOIN to the LO signal generator with an LO power of 4 dBm (typical).
6. Apply the IF1 and IF2 signals.

EV1HMC815BLC5 Power-Off Sequence

To turn off the EV1HMC815BLC5, take the following steps:

1. Turn off the LO and IF signals.
2. Set VGG to -2 V.
3. Set the VDD1, VDD2, and VDD3 supplies to 0 V and then turn them off.
4. Turn off the VGG supply.

Layout

Solder the exposed pad on the underside of the HMC815B to a low thermal and electrical impedance ground plane. This exposed pad is typically soldered to an exposed opening in the solder mask on the evaluation board. Connect these ground vias to all other ground layers on the evaluation board to maximize heat dissipation from the device package. Figure 105 and Figure 106 show the PCB land pattern footprint for the HMC815B and the solder paste stencil for the HMC815B evaluation board, respectively.

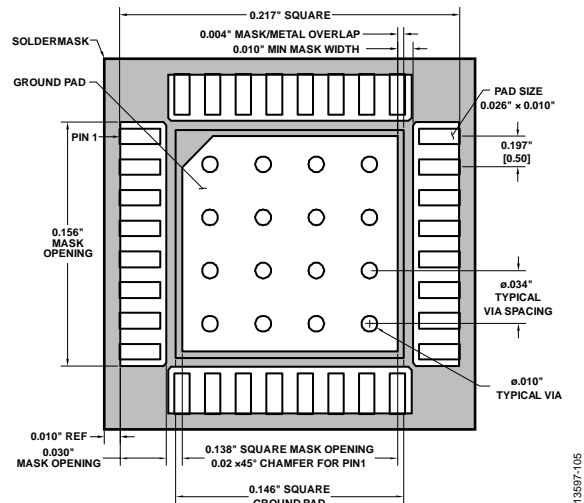

Figure 105. PCB Land Pattern Footprint

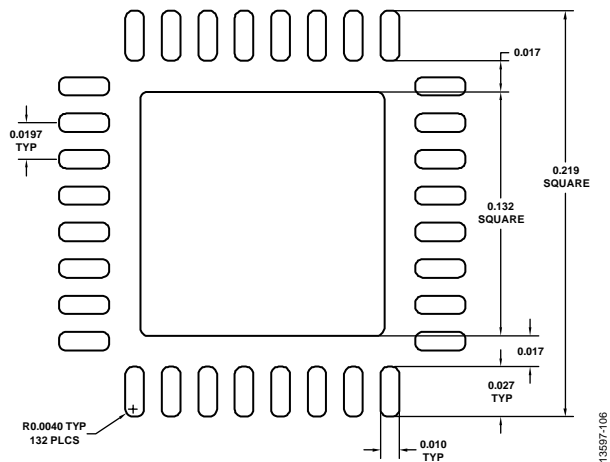

Figure 106. Solder Paste Stencil

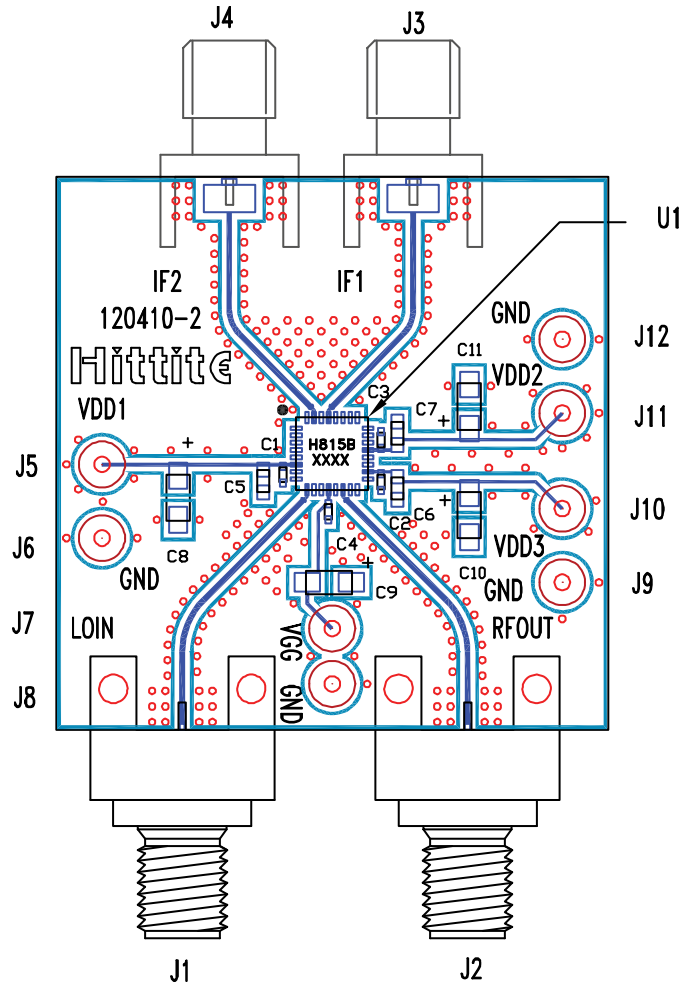

Figure 107. HMC815B Evaluation Board Top Layer

Table 5. Bill of Materials for the EV1HMC815BLC5 Evaluation Board PCB

Quantity	Reference Designator	Description	Manufacturer	Part Number
1	Not applicable	PCB, EV1HMC815BLC5	Analog Devices supplied	120410
1	HMC815B	Mixer, 21 GHz to 27 GHz upconverter	Analog Devices	HMC815B
4	J1, J2	Connector, end launch, 2.92 mm, 40 GHz, jack	Southwest Microwave, Inc.	1092-01A
2	J3, J4	Johnson Subminiature Version A (SMA) connectors	Cinch Connectivity Solutions Johnson	142-0701-851
8	J5 to J12	DC pin, PCB terminal	Mill-Max Manufacturing Corporation	3101-2-00-21-00-00-08-0
3	C1, C2, C3,	Ceramic capacitors, 100 pF, 5%, 50 V, COG, 0402	Kemet	C0402C101J5GACTU
1	C4	Ceramic capacitors, 1000 pF, 50 V, X7R, 0402	Murata Manufacturing	GRM155R71H102KA01D
3	C5, C6, C7	Ceramic capacitors, 1000 pF, 50 V, 10%, X7R, 0603	Murata Manufacturing	GRM188R71H102KA01D
4	C8, C9, C10, C11	Tantalum capacitors, 2.2 μF, 25 V, 10%, SMD, Case A	AVX Corporation	TAJA225K025RNJ

OUTLINE DIMENSIONS

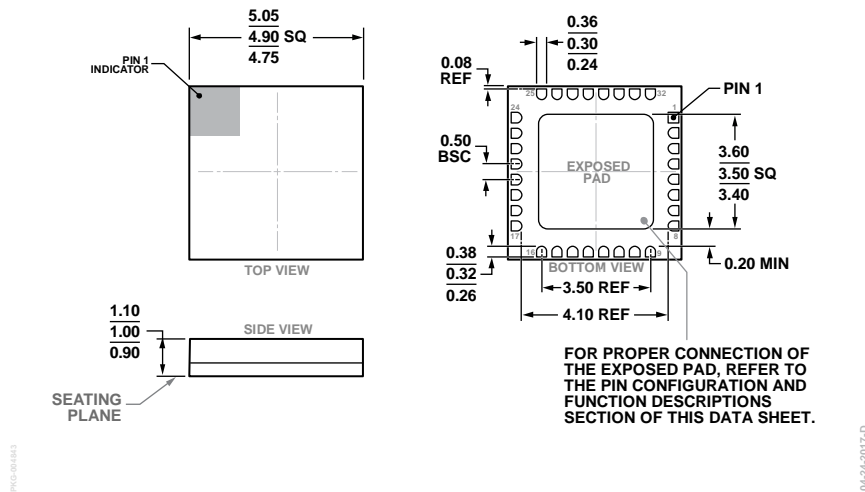

Figure 108. 32-Terminal Ceramic Leadless Chip Carrier [LCC] (E-32-1)
Dimensions shown in millimeters

ORDERING GUIDE

Model ¹	Temperature Range	Package Body Material	Lead Finish	MSL Rating ²	Package Description	Package Option
HMC815BLC5	-40°C to +85°C	Alumina Ceramic	Gold over Nickel	MSL3	32-Terminal LCC	E-32-1
HMC815BLC5TR	-40°C to +85°C	Alumina Ceramic	Gold over Nickel	MSL3	32-Terminal LCC	E-32-1
HMC815BLC5TR-R5	-40°C to +85°C	Alumina Ceramic	Gold over Nickel	MSL3	32-Terminal LCC	E-32-1
EV1HMC815BLC5					Evaluation PCB Assembly	

¹ The HMC815BLC5, HMC815BLC5TR, and the HMC815BLC5TR-R5 are RoHS compliant parts.

² See the Absolute Maximum Ratings section.



Стандарт Электрон Связь

Мы молодая и активно развивающаяся компания в области поставок электронных компонентов. Мы поставляем электронные компоненты отечественного и импортного производства напрямую от производителей и с крупнейших складов мира.

Благодаря сотрудничеству с мировыми поставщиками мы осуществляем комплексные и плановые поставки широчайшего спектра электронных компонентов.

Собственная эффективная логистика и склад в обеспечивает надежную поставку продукции в точно указанные сроки по всей России.

Мы осуществляем техническую поддержку нашим клиентам и предпродажную проверку качества продукции. На все поставляемые продукты мы предоставляем гарантию .

Осуществляем поставки продукции под контролем ВП МО РФ на предприятия военно-промышленного комплекса России , а также работаем в рамках 275 ФЗ с открытием отдельных счетов в уполномоченном банке. Система менеджмента качества компании соответствует требованиям ГОСТ ISO 9001.

Минимальные сроки поставки, гибкие цены, неограниченный ассортимент и индивидуальный подход к клиентам являются основой для выстраивания долгосрочного и эффективного сотрудничества с предприятиями радиоэлектронной промышленности, предприятиями ВПК и научно-исследовательскими институтами России.

С нами вы становитесь еще успешнее!

Наши контакты:

Телефон: +7 812 627 14 35

Электронная почта: sales@st-electron.ru

Адрес: 198099, Санкт-Петербург,
Промышленная ул, дом № 19, литера Н,
помещение 100-Н Офис 331