

# NCP1072, NCP1075

## High-Voltage Switcher for Low Power Offline SMPS

The NCP1072/NCP1075 products integrate a fixed frequency current mode controller with a 700 V MOSFET. Available in a PDIP-7 or SOT-223 package, the NCP1072/5 offer a high level of integration, including soft-start, frequency-jittering, short-circuit protection, skip-cycle, a maximum peak current set point, ramp compensation, and a Dynamic Self-Supply (eliminating the need for an auxiliary winding).

Unlike other monolithic solutions, the NCP1072/5 is quiet by nature: during nominal load operation, the part switches at one of the available frequencies (65, 100 or 130 kHz). When the output power demand diminishes, the IC automatically enters frequency foldback mode and provides excellent efficiency at light loads. When the power demand reduces further, it enters into a skip mode to reduce the standby consumption down to a no load condition.

Protection features include: a timer to detect an overload or a short-circuit event, Overvoltage Protection with auto-recovery and AC input line voltage detection.

For improved standby performance, the connection of an auxiliary winding stops the DSS operation and helps to reduce input power consumption below 50 mW at high line.



ON Semiconductor®

<http://onsemi.com>

### MARKING DIAGRAMS



SOT-223  
ST SUFFIX  
CASE 318E



PDIP-7  
P SUFFIX  
CASE 626A



- x = Current Limit (2 or 5)
- y = Oscillator Frequency  
A (65 kHz), B (100 kHz), C (130 kHz)
- yyy = 065, 100, 130
- A = Assembly Location
- WL = Wafer Lot
- Y, YY = Year
- W, WW = Work Week
- G or ■ = Pb-Free Package

### ORDERING INFORMATION

See detailed ordering and shipping information in the package dimensions section on page 24 of this data sheet.

### Features

- Built-in 700 V MOSFET with  $R_{DS(on)}$  of 11  $\Omega$
- Large Creepage Distance Between High-voltage Pins
- Current-Mode Fixed Frequency Operation – 65 / 100 / 130 kHz (NCP1072 130 kHz on demand only)
- Peak Current: NCP1072 with 250 mA and NCP1075 with 450 mA
- Fixed Ramp Compensation
- Skip-Cycle Operation at Low Peak Currents Only: No Acoustic Noise!
- Dynamic Self-Supply: No Need for an Auxiliary Winding
- Internal 1 ms Soft-Start
- Auto-Recovery Output Short Circuit Protection with Timer-Based Detection
- Auto-Recovery Overvoltage Protection with Auxiliary Winding Operation
- Frequency Jittering for Better EMI Signature, Including Frequency Foldback Mode
- No Load Input Consumption < 50 mW
- Frequency Foldback to Improve Efficiency at Light Load
- Internal Temperature Shutdown
- These are Pb-Free Devices

### Typical Applications

- Auxiliary / Standby Isolated Power Supplies White Goods / Smart Meter / E-Meter

# NCP1072, NCP1075

## PIN CONNECTIONS



Figure 1. Pin Connections

### INDICATIVE MAXIMUM OUTPUT POWER

$R_{DS(on)} - I_P$	230 Vac	100 – 250 Vac
11 $\Omega$ – 450 mA DSS	14 W	7 W
11 $\Omega$ – 450 mA Auxiliary Winding	19 W	10 W

NOTE: Informative values only, with  $T_{amb} = 50^\circ\text{C}$ ,  $F_{sw} = 65\text{ kHz}$ , circuit mounted on minimum copper area as recommended.

### QUICK SELECTION TABLE

	NCP1072			NCP1075		
$R_{DS(on)}$ ( $\Omega$ )	11			11		
$I_{peak}$ (mA)	250			450		
Freq (kHz)	65	100	130	65	100	130
Package	PDIP / SOT223			PDIP / SOT223		

NOTE: NCP1072 130 kHz on demand only.



Figure 2. Typical Application Example

# NCP1072, NCP1075

## PIN FUNCTION DESCRIPTION

Pin N°	Pin Name	Function	Pin Description
1	V <sub>CC</sub>	Powers the internal circuitry	This pin is connected to an external capacitor. The V <sub>CC</sub> includes an active shunt which serves as an auto-recovery over voltage protection.
2	NC		
3	GND	The IC Ground	
4	FB	Feedback signal input	By connecting an opto-coupler to this pin, the peak current set point is adjusted accordingly to the output power demand.
5	Drain	Drain connection	The internal drain MOSFET connection
6			This un-connected pin ensures adequate creepage distance
7	GND	The IC Ground	
8	GND	The IC Ground	



Figure 3. Simplified Internal Circuit Architecture

# NCP1072, NCP1075

## MAXIMUM RATINGS TABLE

Symbol	Rating	Value	Unit	
V <sub>CC</sub>	Power Supply Voltage on all pins, except Pin 5(Drain)	-0.3 to 10	V	
BV <sub>dss</sub>	Drain voltage	-0.3 to 700	V	
I <sub>DS(PK)</sub>	Drain Current Peak during Transformer Saturation	2 x I <sub>peak(0)</sub>	A	
I <sub>VCC</sub>	Maximum Current into Pin 1 when Activating the 8.2 V Active Clamp	15	mA	
R <sub>θJ-A</sub>	P Suffix, Case 626A	0.36 Sq. Inch	77	°C/W
	Junction-to-Air, 2.0 oz Printed Circuit Copper Clad	1.0 Sq. Inch	60	
R <sub>θJ-A</sub>	ST Suffix, Plastic Package Case 318E	0.36 Sq. Inch	74	°C/W
	Junction-to-Air, 2.0 oz Printed Circuit Copper Clad	1.0 Sq. Inch	55	
T <sub>JMAX</sub>	Maximum Junction Temperature	150	°C	
	Storage Temperature Range	-60 to +150	°C	
	ESD Capability, HBM model (All pins except HV)	2	kV	
	ESD Capability, Machine Model	200	V	

Stresses exceeding Maximum Ratings may damage the device. Maximum Ratings are stress ratings only. Functional operation above the Recommended Operating Conditions is not implied. Extended exposure to stresses above the Recommended Operating Conditions may affect device reliability.

- This device series contains ESD protection and exceeds the following tests:  
Human Body Model 2000 V per JEDEC JESD22-A114-F  
Machine Model Method 200 V per JEDEC JESD22-A115-A
- This device contains latch-up protection and exceeds 100 mA per JEDEC Standard JESD78

## ELECTRICAL CHARACTERISTICS

(For typical values T<sub>J</sub> = 25°C, for min/max values T<sub>J</sub> = -40°C to +125°C, V<sub>CC</sub> = 8 V unless otherwise noted)

Symbol	Rating	Pin	Min	Typ	Max	Unit
--------	--------	-----	-----	-----	-----	------

### SUPPLY SECTION AND V<sub>CC</sub> MANAGEMENT

V <sub>CC(on)</sub>	V <sub>CC</sub> increasing level at which the switcher starts operation	1	7.8	8.2	8.6	V
V <sub>CC(min)</sub>	V <sub>CC</sub> decreasing level at which the HV current source restarts	1	6.5	6.8	7.2	V
V <sub>CC(off)</sub>	V <sub>CC</sub> decreasing level at which the switcher stops operation (UVLO)	1	6.1	6.3	6.6	V
V <sub>CC(reset)</sub>	V <sub>CC</sub> voltage at which the internal latch is reset (guaranteed by design)	1		4		V
V <sub>CC(clamp)</sub>	Offset voltage above V <sub>CC(on)</sub> at which the internal clamp activates	1	130	190	300	mV
I <sub>CC1</sub>	Internal IC consumption, MOSFET switching at 65 kHz	1		0.7	1.0	mA
I <sub>CCskip</sub>	Internal IC consumption, FB is 0 V (No switching on MOSFET)	1		360		μA

### POWER SWITCH CIRCUIT

R <sub>DS(on)</sub>	Power Switch Circuit on-state resistance NCP107x (I <sub>d</sub> = 50 mA) T <sub>J</sub> = 25°C T <sub>J</sub> = 125°C	5		11 19	16 24	Ω
BV <sub>DSS</sub>	Power Switch Circuit & Startup breakdown voltage (I <sub>D(off)</sub> = 120 μA, T <sub>J</sub> = 25°C)	5	700			V
I <sub>DSS(off)</sub>	Power Switch & Startup breakdown voltage off-state leakage current T <sub>J</sub> = 125°C (V <sub>ds</sub> = 700 V)	5		85		μA
t <sub>on</sub> t <sub>off</sub>	Switching characteristics (R <sub>L</sub> = 50 Ω, V <sub>DS</sub> set for I <sub>drain</sub> = 0.7 x I <sub>lim</sub> ) Turn-on time (90% - 10%) Turn-off time (10% - 90%)	5 5		20 10		ns

### INTERNAL START-UP CURRENT SOURCE

I <sub>start1</sub>	High-voltage current source, V <sub>CC</sub> = V <sub>CC(on)</sub> - 200 mV	5	5	9	12	mA
---------------------	---	---	---	---	----	----

- The final switch current is: I<sub>PK(0)</sub> / (V<sub>in</sub>/L<sub>P</sub> + S<sub>a</sub>) x V<sub>in</sub>/L<sub>P</sub> + V<sub>in</sub>/L<sub>P</sub> x t<sub>prop</sub>, with S<sub>a</sub> the built-in slope compensation, V<sub>in</sub> the input voltage, L<sub>P</sub> the primary inductor in a flyback, and t<sub>prop</sub> the propagation delay..
- NCP1072 130 kHz on demand only.
- Oscillator frequency is measured with disabled jittering.

# NCP1072, NCP1075

## ELECTRICAL CHARACTERISTICS

(For typical values  $T_J = 25^\circ\text{C}$ , for min/max values  $T_J = -40^\circ\text{C}$  to  $+125^\circ\text{C}$ ,  $V_{CC} = 8\text{ V}$  unless otherwise noted)

Symbol	Rating	Pin	Min	Typ	Max	Unit
--------	--------	-----	-----	-----	-----	------

### INTERNAL START-UP CURRENT SOURCE

$I_{\text{start2}}$	High-voltage current source, $V_{CC} = 0\text{ V}$	5		0.5		mA
$V_{\text{CCTH}}$	VCC Transient level for $I_{\text{start1}}$ to $I_{\text{start2}}$ toggling point	1	-	2.2	-	V

### CURRENT COMPARATOR

$I_{\text{IPK}}$	Maximum internal current setpoint at 50% duty cycle FB pin open, NCP1072, $T_J = 25^\circ\text{C}$	-		250		mA
$I_{\text{IPK}}$	Maximum internal current setpoint at 50% duty cycle FB pin open, NCP1075, $T_J = 25^\circ\text{C}$	-		450		mA
$I_{\text{IPK(0)}}$	Maximum internal current setpoint at beginning of switching cycle FB pin open, NCP1072, $T_J = 25^\circ\text{C}$	-	254	282	310	mA
$I_{\text{IPKSW}}$	Final switch current with a primary slope of $200\text{ mA}/\mu\text{s}$ , $F_{\text{SW}} = 65\text{ kHz}$ , NCP1072 (Note 3)			296		mA
$I_{\text{IPKSW}}$	Final switch current with a primary slope of $200\text{ mA}/\mu\text{s}$ , $F_{\text{SW}} = 100\text{ kHz}$ , NCP1072 (Note 3)			293		mA
$I_{\text{IPKSW}}$	Final switch current with a primary slope of $200\text{ mA}/\mu\text{s}$ , $F_{\text{SW}} = 130\text{ kHz}$ , NCP1072 (Notes 3 and 4)			291		mA
$I_{\text{IPK(0)}}$	Maximum internal current setpoint at beginning of switching cycle FB pin open, NCP1075, $T_J = 25^\circ\text{C}$	-	467	508	549	mA
$I_{\text{IPKSW}}$	Final switch current with a primary slope of $200\text{ mA}/\mu\text{s}$ , $F_{\text{SW}} = 65\text{ kHz}$ , NCP1075 (Note 3)			510		mA
$I_{\text{IPKSW}}$	Final switch current with a primary slope of $200\text{ mA}/\mu\text{s}$ , $F_{\text{SW}} = 100\text{ kHz}$ , NCP1075 (Note 3)			500		mA
$I_{\text{IPKSW}}$	Final switch current with a primary slope of $200\text{ mA}/\mu\text{s}$ , $F_{\text{SW}} = 130\text{ kHz}$ , NCP1075 (Note 3)			493		mA
$T_{\text{SS}}$	Soft-start duration (guaranteed by design)	-		1		ms
$T_{\text{prop}}$	Propagation delay from current detection to drain OFF state	-		100		ns

### INTERNAL OSCILLATOR

$f_{\text{OSC}}$	Oscillation frequency, 65 kHz version, $T_J = 25^\circ\text{C}$ (Note 5)	-	59	65	71	kHz
$f_{\text{OSC}}$	Oscillation frequency, 100 kHz version, $T_J = 25^\circ\text{C}$ (Note 5)	-	90	100	110	kHz
$f_{\text{OSC}}$	Oscillation frequency, 130 kHz version, $T_J = 25^\circ\text{C}$ (Notes 4 and 5)	-	117	130	143	kHz
$f_{\text{jitter}}$	Frequency jittering in percentage of $f_{\text{OSC}}$	-		$\pm 6$		%
$f_{\text{swing}}$	Jittering swing frequency	-		300		Hz
$D_{\text{max}}$	Maximum duty-cycle	-	62	68	72	%

### FEEDBACK SECTION

$I_{\text{FBfault}}$	FB current for which Fault is detected	4		-35		$\mu\text{A}$
$I_{\text{FB100\%}}$	FB current for which internal current set-point is 100% ( $I_{\text{IPK(0)}}$ )	4		-44		$\mu\text{A}$
$I_{\text{FBfreeze}}$	FB current for which internal current setpoint is 97 mA (NCP1072) or 158 mA (NCP1075)	4		-80		$\mu\text{A}$
$V_{\text{FB(REF)}}$	Equivalent pull-up voltage in linear regulation range (Guaranteed by design)	4		3.3		V
$R_{\text{FB(up)}}$	Equivalent feedback resistor in linear regulation range (Guaranteed by design)	4		19.5		k $\Omega$

3. The final switch current is:  $I_{\text{IPK(0)}} / (V_{\text{in}}/L_P + S_a) \times V_{\text{in}}/L_P + V_{\text{in}}/L_P \times t_{\text{prop}}$ , with  $S_a$  the built-in slope compensation,  $V_{\text{in}}$  the input voltage,  $L_P$  the primary inductor in a flyback, and  $t_{\text{prop}}$  the propagation delay..

4. NCP1072 130 kHz on demand only.

5. Oscillator frequency is measured with disabled jittering.

# NCP1072, NCP1075

## ELECTRICAL CHARACTERISTICS

(For typical values  $T_J = 25^\circ\text{C}$ , for min/max values  $T_J = -40^\circ\text{C}$  to  $+125^\circ\text{C}$ ,  $V_{CC} = 8\text{ V}$  unless otherwise noted)

Symbol	Rating	Pin	Min	Typ	Max	Unit
--------	--------	-----	-----	-----	-----	------

### FREQUENCY FOLDBACK & SKIP

$I_{FBfold}$	Start of frequency foldback feedback level	4		-68		$\mu\text{A}$
$I_{FBfold(end)}$	End of frequency foldback feedback level, $F_{sw} = F_{min}$	4		-100		$\mu\text{A}$
$F_{min}$	The frequency below which skip-cycle occurs	-	21	25	29	kHz
$I_{FBskip}$	The feedback level to enter skip mode	4		-120		$\mu\text{A}$
$I_{freeze}$	Internal minimum current setpoint ( $I_{FB} = -90\ \mu\text{A}$ ) in NCP1072			88		mA
$I_{freeze}$	Internal minimum current setpoint ( $I_{FB} = -90\ \mu\text{A}$ ) in NCP1075			168		mA

### RAMP COMPENSATION

$S_{a(65)}$	The internal ramp compensation in NCP1072 (65 kHz version)	-		4.2		kA/s
$S_{a(65)}$	The internal ramp compensation in NCP1075 (65 kHz version)	-		7.5		kA/s
$S_{a(100)}$	The internal ramp compensation in NCP1072 (100 kHz version)	-		6.5		kA/s
$S_{a(100)}$	The internal ramp compensation in NCP1075 (100 kHz version)	-		11.5		kA/s
$S_{a(130)}$	The internal ramp compensation in NCP1072 (130 kHz version) (Note 4)	-		8.4		kA/s
$S_{a(130)}$	The internal ramp compensation in NCP1075 (130 kHz version)	-		15		kA/s

### PROTECTIONS

$t_{SCP}$	Fault validation further to error flag assertion	-	40	53		ms
$t_{recovery}$	OFF phase in fault mode	-		420		ms
$I_{OVP}$	$V_{CC}$ clamp current at which the switcher stops pulsing	1	6.0	8.5	11	mA
$t_{OVP}$	The filter of $V_{CC}$ OVP comparator	-		80		$\mu\text{s}$
$V_{HV(EN)}$	The drain pin voltage above which allows MOSFET operate, which is detected after TSD, UVLO, SCP, or $V_{CC}$ OVP mode.	5	72	91	110	V

### TEMPERATURE MANAGEMENT

TSD	Temperature shutdown (Guaranteed by design)	-	150			$^\circ\text{C}$
	Hysteresis in shutdown (Guaranteed by design)	-		50		$^\circ\text{C}$

- The final switch current is:  $I_{PK(0)} / (V_{in}/L_P + S_a) \times V_{in}/L_P + V_{in}/L_P \times t_{prop}$ , with  $S_a$  the built-in slope compensation,  $V_{in}$  the input voltage,  $L_P$  the primary inductor in a flyback, and  $t_{prop}$  the propagation delay..
- NCP1072 130 kHz on demand only.
- Oscillator frequency is measured with disabled jittering.

# NCP1072, NCP1075

## TYPICAL CHARACTERISTICS



Figure 4. V<sub>CC(on)</sub> vs. Temperature

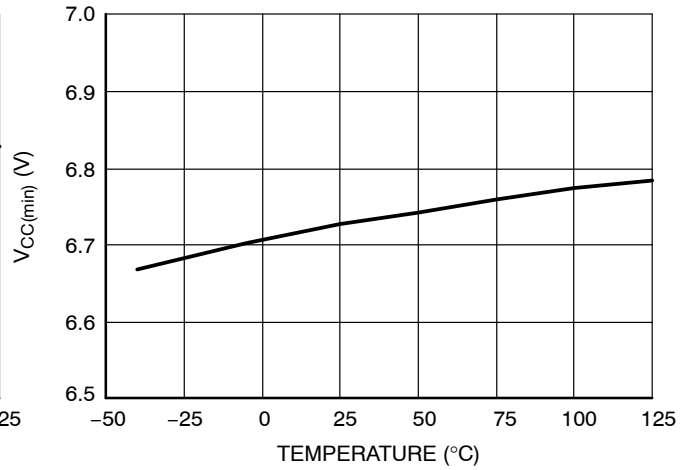

Figure 5. V<sub>CC(min)</sub> vs. Temperature



Figure 6. V<sub>CC(off)</sub> vs. Temperature

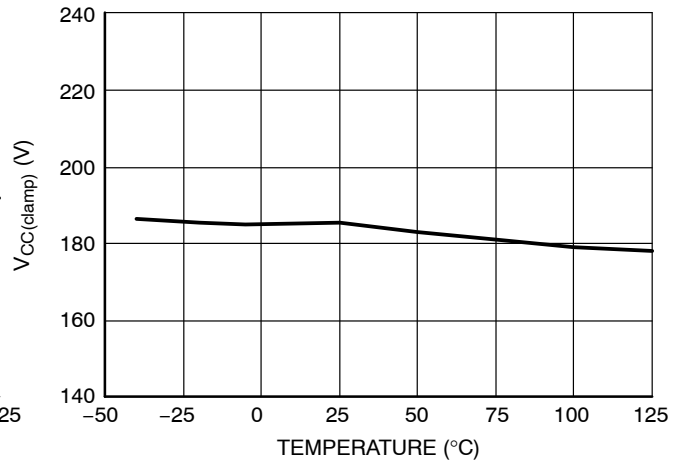

Figure 7. V<sub>CC(clamp)</sub> vs. Temperature



Figure 8. I<sub>CC1</sub> vs. Temperature

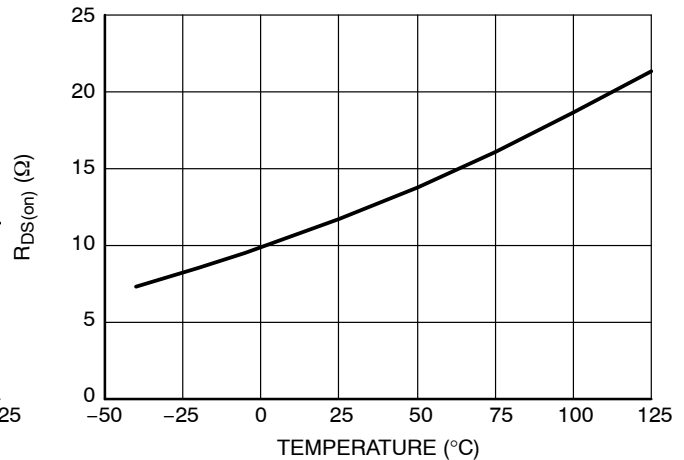

Figure 9. R<sub>DS(on)</sub> vs. Temperature

# NCP1072, NCP1075

## TYPICAL CHARACTERISTICS



Figure 10.  $I_{DSS(off)}$  vs. Temperature



Figure 11.  $I_{start1}$  vs. Temperature



Figure 12.  $I_{start2}$  vs. Temperature



Figure 13.  $I_{IPK(0)}$  vs. Temperature



Figure 14.  $F_{osc}$  vs. Temperature



Figure 15.  $D_{(max)}$  vs. Temperature



# NCP1072, NCP1075

## TYPICAL CHARACTERISTICS



Figure 16. F<sub>min</sub> vs. Temperature



Figure 17. t<sub>SCP</sub> vs. Temperature



Figure 18. t<sub>recovery</sub> vs. Temperature



Figure 19. I<sub>OVP</sub> vs. Temperature



Figure 20. V<sub>HV(EN)</sub> vs. Temperature

## APPLICATION INFORMATION

### Introduction

The NCP1072/NCP1075 offers a complete current-mode control solution. The component integrates everything needed to build a rugged and low-cost Switch-Mode Power Supply (SMPS) featuring low standby power. The Quick Selection Table on page 2 details the differences between references, mainly peak current setpoints and operating frequency.

- Current-mode operation: the controller uses current-mode control architecture.
- 700 V – 11  $\Omega$  Power MOSFET: Due to ON Semiconductor Very High Voltage Integrated Circuit technology, the circuit hosts a high-voltage power MOSFET featuring a 11  $\Omega$   $R_{DS(on)} - T_J = 25^\circ\text{C}$ . This value lets the designer build a power supply up to 10 W operated on universal mains. An internal current source delivers the startup current, necessary to crank the power supply.
- Dynamic Self-Supply: Due to the internal high voltage current source, this device could be used in the application without the auxiliary winding to provide supply voltage.
- Short circuit protection: by permanently monitoring the feedback line activity, the IC is able to detect the presence of a short-circuit, immediately reducing the output power for a total system protection. A  $t_{SCP}$  timer is started as soon as the feedback current is below threshold,  $I_{FB(fault)}$ , which indicates the maximum peak current. If at the end of this timer the fault is still present, then the device enters a safe, auto-recovery burst mode, affected by a fixed timer recurrence,  $t_{recovery}$ . Once the short has disappeared, the controller resumes and goes back to normal operation.
- Built-in  $V_{CC}$  Over Voltage Protection: when the auxiliary winding is used to bias the  $V_{CC}$  pin (no DSS), an internal active clamp connected between  $V_{CC}$  and ground limits the supply dynamics to  $V_{CC(clamp)}$ . In case the current injected in this clamp exceeds a level of 6.0 mA (minimum), the controller immediately stops switching and waits a full timer period ( $t_{recovery}$ ) before

attempting to restart. If the fault is gone, the controller resumes operation. If the fault is still there, e.g. a broken opto-coupler, the controller protects the load through a safe burst mode.

- Line detection: An internal comparator monitors the drain voltage as recovering from one of the following situations:
  - ◆ Short Circuit Protection,
  - ◆  $V_{CC}$  OVP is confirmed,
  - ◆ UVLO
  - ◆ TSD

If the drain voltage is lower than the internal threshold ( $V_{HV(EN)}$ ), the internal power switch is inhibited. This avoids operating at too low ac input. This is also called brown-in function in some fields.
- Frequency jittering: an internal low-frequency modulation signal varies the pace at which the oscillator frequency is modulated. This helps spreading out energy in conducted noise analysis. To improve the EMI signature at low power levels, the jittering remains active in frequency foldback mode.
- Soft-Start: a 1 ms soft-start ensures a smooth startup sequence, reducing output overshoots.
- Frequency foldback capability: a continuous flow of pulses is not compatible with no-load/light-load standby power requirements. To excel in this domain, the controller observes the feedback current information and when it reaches a level of  $I_{FBfold}$ , the oscillator then starts to reduce its switching frequency as the feedback current continues to increase (the power demand continues to reduce). It can go down to 25 kHz (typical) reached for a feedback level of  $I_{FBfold(end)}$  (100  $\mu\text{A}$  roughly). At this point, if the power continues to drop, the controller enters classical skip-cycle mode.
- Skip: if SMPS naturally exhibits a good efficiency at nominal load, they begin to be less efficient when the output power demand diminishes. By skipping un-needed switching cycles, the NCP1072/NCP1075 drastically reduces the power wasted during light load conditions.

# NCP1072, NCP1075

## APPLICATION INFORMATION

### Startup Sequence

When the power supply is first powered from the mains outlet, the internal current source (typically 8.0 mA) is biased and charges up the  $V_{CC}$  capacitor from the drain pin. Once the voltage on this  $V_{CC}$  capacitor reaches the  $V_{CC(on)}$

level (typically 8.2 V), the current source turns off and pulses are delivered by the output stage: the circuit is awake and activates the power MOSFET if the bulk voltage is above  $V_{HV(EN)}$  level (91 V typically). Figure 21 details the simplified internal circuitry.

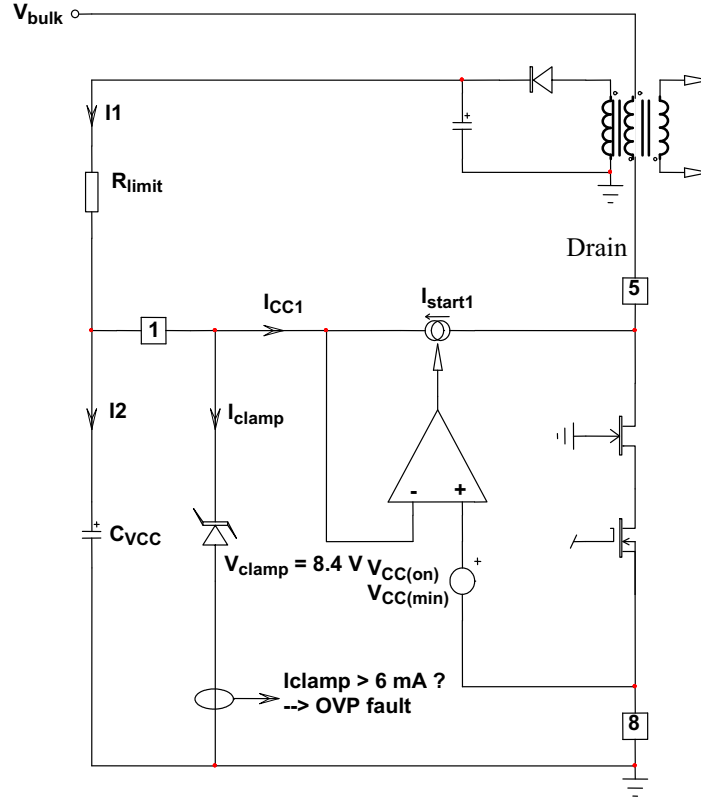

Figure 21. The Internal Arrangement of the Start-up Circuitry

Being loaded by the circuit consumption, the voltage on the  $V_{CC}$  capacitor goes down. When  $V_{CC}$  is below  $V_{CC(min)}$  level (6.8 V typically), it activates the internal current source to bring  $V_{CC}$  toward  $V_{CC(on)}$  level and stops again: a cycle takes place whose low frequency depends on the  $V_{CC}$

capacitor and the IC consumption. A 1.4 V ripple takes place on the  $V_{CC}$  pin whose average value equals  $(V_{CC(on)} + V_{CC(min)})/2$ . Figure 22 portrays a typical operation of the DSS.



Figure 22. The Charge/Discharge Cycle Over a 1 µF V<sub>CC</sub> Capacitor

As one can see, even if there is auxiliary winding to provide energy for V<sub>CC</sub>, it happens that the device is still biased by DSS during start-up time or some fault mode when the voltage on auxiliary winding is not ready yet. The V<sub>CC</sub> capacitor shall be dimensioned to avoid V<sub>CC</sub> crosses V<sub>CC(off)</sub> level, which stops operation. The ΔV between V<sub>CC(min)</sub> and V<sub>CC(off)</sub> is 0.4 V. There is no current source to charge V<sub>CC</sub> capacitor when driver is on, i.e. drain voltage is close to zero. Hence the V<sub>CC</sub> capacitor can be calculated using

$$C_{VCC} \geq \frac{I_{CC1} D_{max}}{f_{OSC} \cdot \Delta V} \quad (\text{eq. 1})$$

Take the 65 kHz device as an example. C<sub>VCC</sub> should be above

$$\frac{0.8m \cdot 72\%}{59 \text{ kHz} \cdot 0.4}$$

A margin that covers the temperature drift and the voltage drop due to switching inside FET should be considered, and thus a capacitor above 0.1 µF is appropriate.

The V<sub>CC</sub> capacitor has only a supply role and its value does not impact other parameters such as fault duration or the frequency sweep period for instance. As one can see on Figure 21, an internal active zener diode, protects the switcher against lethal V<sub>CC</sub> runaways. This situation can occur if the feedback loop optocoupler fails, for instance, and you would like to protect the converter against an over voltage event. In that case, the internal current increase incurred by the V<sub>CC</sub> rapid growth triggers the over voltage

protection (OVP) circuit and immediately stops the output pulses for t<sub>recovery</sub> duration (420 ms typically). Then a new start-up attempt takes place to check whether the fault has disappeared or not. The OVP paragraph gives more design details on this particular section.

#### Fault Condition – Short-Circuit on V<sub>CC</sub>

In some fault situations, a short-circuit can purposely occur between V<sub>CC</sub> and GND. In high line conditions (V<sub>HV</sub> = 370 V<sub>DC</sub>) the current delivered by the startup device will seriously increase the junction temperature. For instance, since I<sub>start1</sub> equals 5 mA (the min corresponds to the highest T<sub>j</sub>), the device would dissipate 370 x 5 m = 1.85 W. To avoid this situation, the controller includes a novel circuitry made of two startup levels, I<sub>start1</sub> and I<sub>start2</sub>. At power-up, as long as V<sub>CC</sub> is below a 2.4 V level, the source delivers I<sub>start2</sub> (around 500 µA typical), then, when V<sub>CC</sub> reaches 2.4 V, the source smoothly transitions to I<sub>start1</sub> and delivers its nominal value. As a result, in case of short-circuit between V<sub>CC</sub> and GND, the power dissipation will drop to 370 x 500µ = 185 mW. Figure 22 portrays this particular behavior.

The first startup period is calculated by the formula C x V = I x t, which implies a 1µ x 2.4 / 500µ = 4.8 ms startup time for the first sequence. The second sequence is obtained by toggling the source to 8 mA with a delta V of V<sub>CC(on)</sub> – V<sub>CCTH</sub> = 8.2 – 2.4 = 5.8 V, which finally leads to a second startup time of 1µ x 5.8 / 8m = 0.725 ms. The total startup time becomes 4.8m + 0.725m = 5.525 ms. Please note that this calculation is approximated by the presence of the knee in the vicinity of the transition.

**Fault Condition – Output Short–Circuit**

As soon as  $V_{CC}$  reaches  $V_{CC(on)}$ , drive pulses are internally enabled. If everything is correct, the auxiliary winding increases the voltage on the  $V_{CC}$  pin as the output voltage rises. During the start–sequence, the controller smoothly ramps up the peak drain current to maximum setting, i.e.  $I_{PK}$ , which is reached after a typical period of 1 ms. When the output voltage is not regulated, the current coming through FB pin is below  $I_{FB(fault)}$  level (35  $\mu$ A typically), which is not only during the startup period but also anytime an overload occurs, an internal error flag is

asserted,  $Ipflag$ , indicating that the system has reached its maximum current limit set point. The assertion of this flag triggers a fault counter  $t_{SCP}$  (53 ms typically). If at counter completion,  $Ipflag$  remains asserted, all driving pulses are stopped and the part stays off in  $t_{recovery}$  duration (about 420 ms). A new attempt to re–start occurs and will last 53 ms providing the fault is still present. If the fault still affects the output, a safe burst mode is entered, affected by a low duty–cycle operation (11%). When the fault disappears, the power supply quickly resumes operation. Figure 23 depicts this particular mode:



**Figure 23. In Case of Short–Circuit or Overload, the NCP107X Protects Itself and the Power Supply Via a Low Frequency Burst Mode. The  $V_{CC}$  is Maintained by the Current Source and Self–supplies the Controller.**

**Auto–Recovery Over Voltage Protection**

The particular NCP107X arrangement offers a simple way to prevent output voltage runaway when the optocoupler fails. As Figure 24 shows, an active zener diode monitors and protects the  $V_{CC}$  pin. Below its equivalent breakdown voltage, that is to say 8.4 V typical, no current flows in it. If the auxiliary  $V_{CC}$  pushes too much current inside the zener, then the controller considers an OVP situation and stops the internal drivers. When an OVP occurs, all switching pulses are permanently disabled. After  $t_{recovery}$  delay, it resumes the internal drivers. If the failure symptom still exists, e.g. feedback opto–coupler fails, the device keeps the auto–recovery OVP mode.

Figure 24 shows that the insertion of a resistor ( $R_{limit}$ ) between the auxiliary dc level and the  $V_{CC}$  pin is mandatory a) not to damage the internal 8.4 V zener diode during an overshoot for instance (absolute maximum current is 15 mA) b) to implement the fail–safe optocoupler protection (OVP) as offered by the active clamp. Please note that there cannot be bad interaction between the clamping voltage of the internal zener and  $V_{CC(on)}$  since this clamping voltage is actually built on top of  $V_{CC(on)}$  with a fixed amount of offset (200 mV typical).  $R_{limit}$  should be carefully selected to avoid

triggering the OVP as we discussed, but also to avoid disturbing the  $V_{CC}$  in low / light load conditions. The below lines detail how to evaluate the  $R_{limit}$  value...

Self–supplying controllers in extremely low standby applications often puzzles the designer. Actually, if a SMPS operated at nominal load can deliver an auxiliary voltage of an arbitrary 16 V ( $V_{nom}$ ), this voltage can drop below 10 V ( $V_{stby}$ ) when entering standby. This is because the recurrence of the switching pulses expands so much that the low frequency re–fueling rate of the  $V_{CC}$  capacitor is not enough to keep a proper auxiliary voltage. Figure 25 portrays a typical scope shot of a SMPS entering deep standby (output un–loaded). Thus, care must be taken when calculating  $R_{limit}$  1) to not trigger the  $V_{CC}$  over current latch (by injecting 6 mA into the active clamp – always use the minimum value for worse case design) in normal operation but 2) not to drop too much voltage over  $R_{limit}$  when entering standby. Otherwise, the converter will enter dynamic self supply mode (DSS mode), which increases the power dissipation. Based on these recommendations, we are able to bound  $R_{limit}$  between two equations:

## NCP1072, NCP1075

$$\frac{V_{\text{nom}} - V_{\text{CC}(\text{clamp})}}{I_{\text{trip}}} \leq R_{\text{limit}} \leq \frac{V_{\text{stby}} - V_{\text{CC}(\text{min})}}{I_{\text{CCskip}}} \quad (\text{eq. 2})$$

Where:

$V_{\text{nom}}$  is the auxiliary voltage at nominal load

$V_{\text{stby}}$  is the auxiliary voltage when standby is entered

$I_{\text{trip}}$  is the current corresponding to the nominal operation. It thus must be selected to avoid false tripping in overshoot conditions. Always use the minimum of the specification for a robust design, i.e.  $I_{\text{trip}} < I_{\text{OVP}}$ .

$I_{\text{CCskip}}$  is the controller consumption during skip mode.

This number decreases compared to normal operation since the part in standby does almost not switch. It is around 0.36 mA for the 65 kHz version.

$V_{\text{CC}(\text{min})}$  is the level above which the auxiliary voltage must be maintained to keep the controller away from the dynamic self supply mode (DSS mode), which is not a problem in itself if low standby power does not matter.

If a further improvement on standby efficiency is concerned, it is good to obtain  $V_{\text{CC}}$  around 8 V at no load condition in order not to re-activate the internal clamp circuit.



**Figure 24. A More Detailed View of the NCP107X Offers Better Insight on How to Properly Wire an Auxiliary Winding**

Since  $R_{\text{limit}}$  shall not bother the controller in standby, e.g. keep  $V_{\text{CC}}$  to above  $V_{\text{CC}(\text{min})}$  (7.2 V maximum), we purposely select a  $V_{\text{nom}}$  well above this value. As explained before, experience shows that a 40% decrease can be seen on auxiliary windings from nominal operation down to standby mode. Let's select a nominal auxiliary winding of 13 V to offer sufficient margin regarding 7.2 V when in standby ( $R_{\text{limit}}$  also drops voltage in standby...). Plugging the values in Equation 2 gives the limits within which  $R_{\text{limit}}$  shall be selected:

$$\frac{13 - 8.4}{6\text{m}} \leq R_{\text{limit}} \leq \frac{8 - 7.2}{0.36\text{m}}$$

that is to say:  $0.77 \text{ k}\Omega < R_{\text{limit}} < 2.2 \text{ k}\Omega$ .

If we design a 65 kHz power supply delivering 12V, then the ratio between auxiliary and power must be:  $13 / 12 =$

1.08. The OVP latch will activate when the clamp current exceeds 6 mA. This will occur when  $V_{\text{auxiliary}}$  grows-up to:

1.  $8.4 + 0.77\text{k} \times (6\text{m} + 0.8\text{m}) \approx 13.6 \text{ V}$  for the first boundary ( $R_{\text{limit}} = 0.77 \text{ k}\Omega$ )
2.  $8.4 + 2.2\text{k} \times (6\text{m} + 0.8\text{m}) \approx 23.4 \text{ V}$  for the second boundary ( $R_{\text{limit}} = 2.2 \text{ k}\Omega$ )

Due to a 1.08 ratio between the auxiliary  $V_{\text{CC}}$  and the power winding, the OVP will be seen as a lower overshoot on the real output:

1.  $13.6 / 1.08 \approx 12.6 \text{ V}$
2.  $23.4 / 1.08 \approx 21.7 \text{ V}$

As one can see, tweaking the  $R_{\text{limit}}$  value will allow the selection of a given overvoltage output level. Theoretically predicting the auxiliary drop from nominal to standby is an

## NCP1072, NCP1075

almost impossible exercise since many parameters are involved, including the converter time constants. Fine tuning of  $R_{limit}$  thus requires a few iterations and experiments on a breadboard to check the auxiliary voltage

variations but also the output voltage excursion in fault. Once properly adjusted, the fail-safe protection will preclude any lethal voltage runaways in case a problem would occur in the feedback loop.



Figure 25. The Burst Frequency Becomes so Low That it is Difficult to Keep an Adequate Level on the Auxiliary  $V_{CC}$ ...

Figure 26 describes the main signal variations when the part operates in auto-recovery OVP:



Figure 26. If the  $V_{CC}$  Current Exceeds a Certain Threshold, an Auto-Recovery Protection is Activated

## NCP1072, NCP1075

### Improving the precision in auto-recovery OVP

Given the OVP variations the internal trip current incur, it is sometimes more interesting to explore a different solution, improving the situation to the cost of a minimal amount of surrounding elements. Figure 27 shows that adding a simple zener diode on top of the limiting resistor, offers a better precision since what matters now is the internal 8.4 V  $V_{CC}$  breakdown plus the zener voltage. A resistor in series with the zener diodes keeps the maximum current in the  $V_{CC}$  pin below the maximum rating of 15 mA just before trip the OVP.



Figure 27. A Simple Zener Diode Added in Parallel

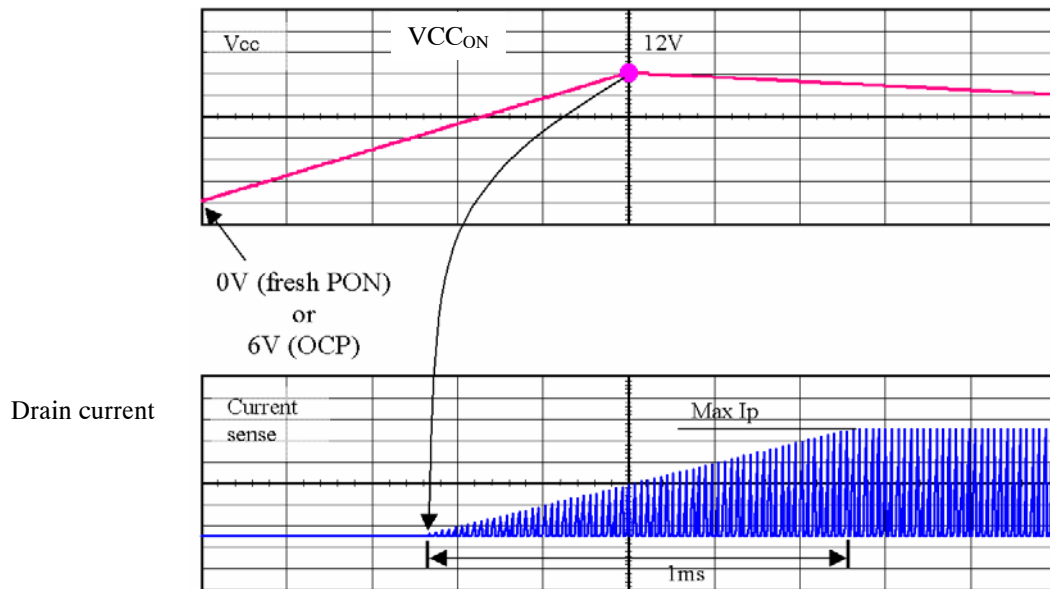

Figure 28. The 1 ms soft-start sequence

### Jittering

Frequency jittering is a method used to soften the EMI signature by spreading the energy in the vicinity of the main switching component. The NCP107X offers a  $\pm 6\%$  deviation of the nominal switching frequency. The sweep

### Soft-Start

The NCP107X features a 1 ms soft-start which reduces the power-on stress but also contributes to lower the output overshoot. Figure 28 shows a typical operating waveform. The NCP107X features a novel patented structure which offers a better soft-start ramp, almost ignoring the start-up pedestal inherent to traditional current-mode supplies:

sawtooth is internally generated and modulates the clock up and down with a fixed frequency of 300 Hz. Figure 29 shows the relationship between the jitter ramp and the frequency deviation. It is not possible to externally disable the jitter.



## NCP1072, NCP1075

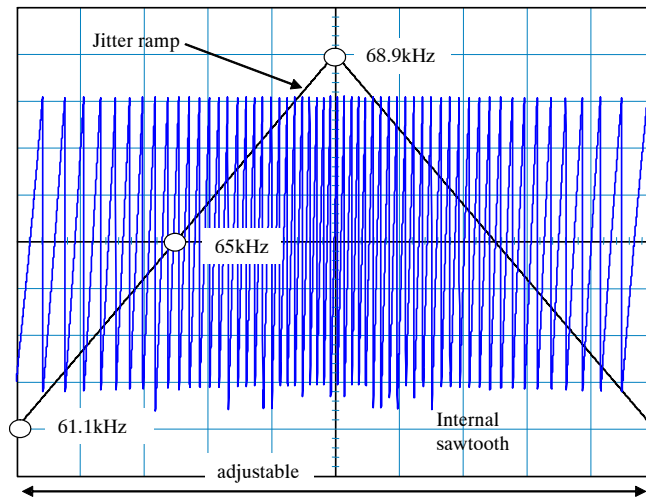

Figure 29. Modulation Effects on the Clock Signal by the Jittering Sawtooth

### Line Detection

An internal comparator monitors the drain voltage as recovering from one of the following situations:

- Short Circuit Protection,
- $V_{CC}$  OVP is confirmed,
- UVLO
- TSD

If the drain voltage is lower than the internal threshold  $V_{HV(EN)}$  (91 Vdc typically), the internal power switch is inhibited. This avoids operating at too low ac input. This is also called brown-in function in some fields.

### Frequency Foldback

The reduction of no-load standby power associated with the need for improving the efficiency, requires to change the traditional fixed-frequency type of operation. This device

implements a switching frequency foldback when the feedback current passes above a certain level,  $I_{FBfold}$ , set around  $68 \mu A$ . At this point, the oscillator enters frequency foldback and reduces its switching frequency.

The internal peak current set-point is following the feedback current information until its level reaches  $I_{freeze}$ . Below this value, the peak current setpoint is frozen to 88 mA (NCP1072) or 168 mA (NCP1075). The only way to further reduce the transmitted power is to diminish the operating frequency down to  $F_{min}$  (25 kHz typically). This value is reached at a feedback current level of  $I_{FBfold(end)}$  ( $100 \mu A$  typically). Below this point, if the output power continues to decrease, the part enters skip cycle for the best noise-free performance in no-load conditions. Figures 30 and 31 depict the adopted scheme for the part.

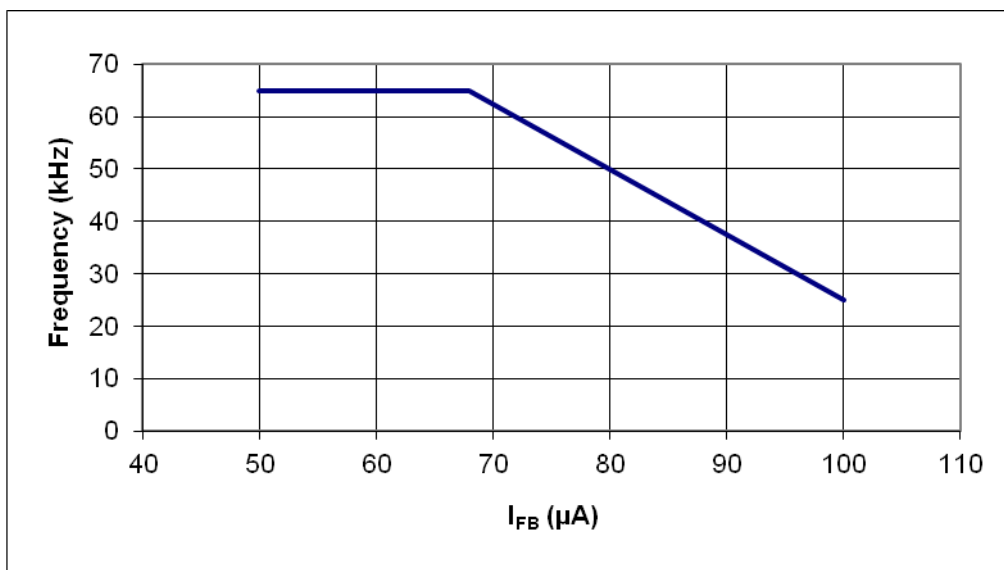

Figure 30. By Observing the Current on the Feedback Pin, the Controller Reduces its Switching Frequency for an Improved Performance at Light Load

## NCP1072, NCP1075



Figure 31. I<sub>pk</sub> Set-point is Frozen at Lower Power Demand.

### Feedback and Skip

Figure 32 depicts the relationship between feedback voltage and current. The feedback pin operates linearly as the absolute value of feedback current ( $I_{FB}$ ) is above  $40 \mu A$ .

In this linear operating range, the dynamic resistance is  $19.5 k\Omega$  typically ( $R_{FB(up)}$ ) and the effective pull up voltage is  $3.3 V$  typically ( $V_{FB(REF)}$ ). When  $I_{FB}$  is below  $40 \mu A$ , the FB voltage will jump to close to  $4.5 V$ .

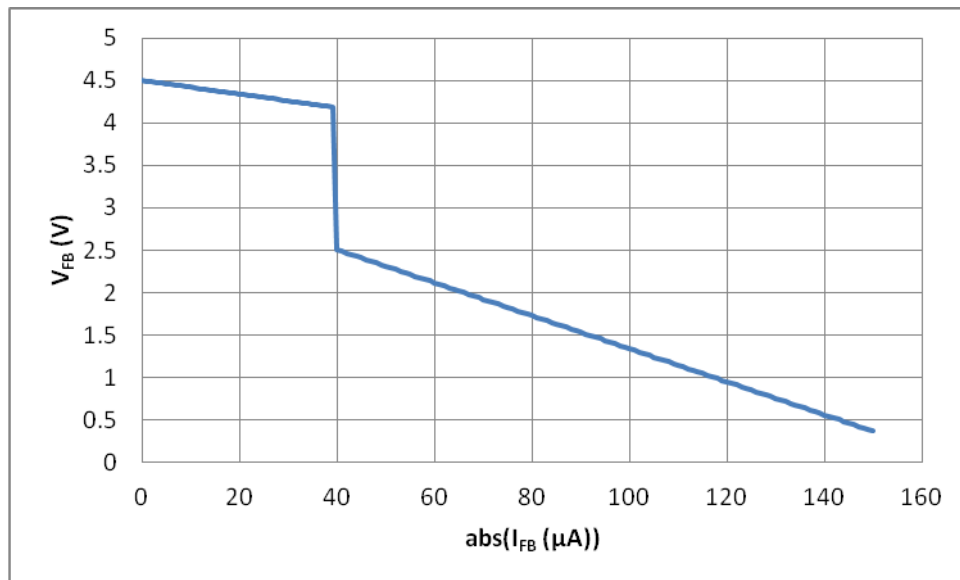

Figure 32. Feedback Voltage vs. Current

Figure 33 depicts the skip mode block diagram. When the FB current information reaches  $I_{FBskip}$ , the internal clock to set the flip-flop is blanked and the internal consumption of the controller is decreased. The hysteresis of internal skip

comparator is minimized to lower the ripple of the auxiliary voltage for  $V_{CC}$  pin and  $V_{OUT}$  of power supply during skip mode. It eases the design of  $V_{CC}$  over load range.

## NCP1072, NCP1075

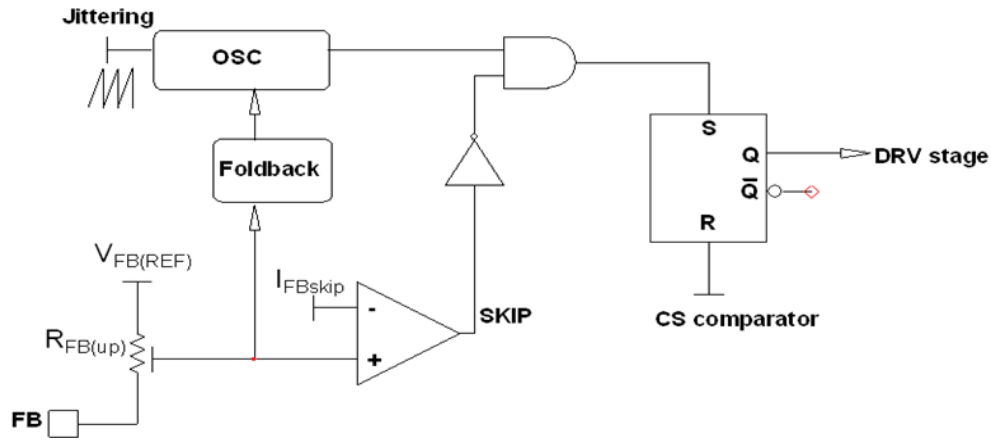

Figure 33. Skip Cycle Schematic

### Ramp Compensation and $I_{pk}$ Set-point

In order to allow the NCP107X to operate in CCM with a duty cycle above 50%, a fixed slope compensation is internally applied to the current-mode control.

Here we got a table of the ramp compensation, the initial current set point, and the final current set-point of different versions of switcher.

	NCP1072			NCP1075		
	65 kHz	100 kHz	130 kHz	65 kHz	100 kHz	130 kHz
$F_{sw}$	65 kHz	100 kHz	130 kHz	65 kHz	100 kHz	130 kHz
$S_a$	4.2 kA/s	6.5 kA/s	8.4 kA/s	7.5 kA/s	11.5 kA/s	15 kA/s
$I_{pk}(Duty = 50\%)$	250 mA			450 mA		
$I_{pk(0)}$	282 mA			508 mA		

The Figure 34 depicts the variation of  $I_{PK}$  set-point vs. the power switcher duty ratio, which is caused by the internal ramp compensation.



Figure 34.  $I_{PK}$  Set-point Varies with Power Switch On Time, Which is Caused by the Ramp Compensation

**Design Procedure**

The design of an SMPS around a monolithic device does not differ from that of a standard circuit using a controller and a MOSFET. However, one needs to be aware of certain characteristics specific of monolithic devices. Let us follow the steps:

$V_{in\ min} = 90\ Vac$  or  $127\ Vdc$  once rectified, assuming a low bulk ripple

$V_{in\ max} = 265\ Vac$  or  $375\ Vdc$

$V_{out} = 12\ V$

$P_{out} = 10\ W$

Operating mode is CCM

$\eta = 0.8$

1. The lateral MOSFET body–diode shall never be forward biased, either during start–up (because of a large leakage inductance) or in normal operation as shown by Figure 35. This condition sets the

maximum voltage that can be reflected during  $t_{off}$ . As a result, the Flyback voltage which is reflected on the drain at the switch opening cannot be larger than the input voltage. When selecting components, you thus must adopt a turn ratio which adheres to the following equation:

$$N(V_{out} + V_f) < V_{in,min} \quad (eq. 3)$$

2. In our case, since we operate from a 127 V DC rail while delivering 12 V, we can select a reflected voltage of 120 Vdc maximum. Therefore, the turn ratio  $N_p:N_s$  must be smaller than

$$\frac{V_{reflect}}{V_{out} + V_f} = \frac{120}{12 + 0.5} = 9.6$$

or  $N_p:N_s < 9.6$ . Here we choose  $N = 8$  in this case. We will see later on how it affects the calculation.



**Figure 35. The Drain–Source Wave Shall Always be Positive**



**Figure 36. Primary Inductance Current Evolution in CCM**

3. Lateral MOSFETs have a poorly doped body–diode which naturally limits their ability to

sustain the avalanche. A traditional RCD clamping network shall thus be installed to protect the MOSFET. In some low power applications, a simple capacitor can also be used since

$$V_{drain,max} = V_{in} + N(V_{out} + V_f) + I_{peak} \sqrt{\frac{L_f}{C_{tot}}} \quad (eq. 4)$$

where  $L_f$  is the leakage inductance,  $C_{tot}$  the total capacitance at the drain node (which is increased by the capacitor you will wire between drain and source),  $N$  the  $N_p:N_s$  turn ratio,  $V_{out}$  the output voltage,  $V_f$  the secondary diode forward drop and finally,  $I_{peak}$  the maximum peak current. Worse case occurs when the SMPS is very close to regulation, e.g. the  $V_{out}$  target is almost reached and  $I_{peak}$  is still pushed to the maximum. For this design, we have selected our maximum voltage around 650 V (at  $V_{in} = 375\ Vdc$ ). This voltage is given by the RCD clamp

installed from the drain to the bulk voltage. We will see how to calculate it later on.

4. Calculate the maximum operating duty-cycle for this flyback converter operated in CCM:

$$d_{\max} = \frac{N(V_{\text{out}} + V_f)}{N(V_{\text{out}} + V_f) + V_{\text{in,min}}} = \frac{1}{1 + \frac{V_{\text{in,min}}}{N(V_{\text{out}} + V_f)}} = 0.44 \quad (\text{eq. 5})$$

5. To obtain the primary inductance, we have the choice between two equations:

$$L = \frac{(V_{\text{in}}d)^2}{f_{\text{sw}}K P_{\text{in}}} \quad (\text{eq. 6})$$

where

$$K = \frac{\Delta I_L}{I_{\text{Lavg}}}$$

and defines the amount of ripple we want in CCM (see Figure 36).

- ♦ Small K: deep CCM, implying a large primary inductance, a low bandwidth and a large leakage inductance.
- ♦ Large K: approaching BCM where the rms losses are worse, but smaller inductance, leading to a better leakage inductance.

From Equation 6, a K factor of 1 (50% ripple), gives an inductance of:

$$L = \frac{(127 \times 0.44)^2}{65k \times 1 \times 12.75} = 3.8 \text{ mH}$$

$$\Delta I_L = \frac{V_{\text{in,min}} \cdot d_{\max}}{L f_{\text{sw}}} = \frac{127 \times 0.44}{3.8 \times 65k}$$

$$= 223 \text{ mA peak-to-peak}$$

The peak current can be evaluated to be:

$$I_{\text{peak}} = \frac{I_{\text{avg}}}{d} + \frac{\Delta I_L}{2} = I_{\text{peak}} = \frac{98\text{m}}{0.44} + \frac{\Delta I_L}{2} = 335 \text{ mA}$$

On  $I_L$ ,  $I_{\text{Lavg}}$  can also be calculated:

$$I_{\text{Lavg}} = I_{\text{peak}} - \frac{\Delta I_L}{2} = 0.34 - 0.112 = 223 \text{ mA}$$

6. Based on the above numbers, we can now evaluate the conduction losses:

$$I_{\text{d,rms}} = \sqrt{d \left( I_{\text{peak}}^2 - I_{\text{peak}} \Delta I_L + \frac{\Delta I_L^2}{3} \right)}$$

$$= \sqrt{0.44 \left( 0.335^2 - 0.335 \cdot 0.223 + \frac{0.223^2}{3} \right)}$$

$$= 154 \text{ mA}$$

If we take the maximum  $R_{\text{ds(on)}}$  for a 125°C junction temperature, i.e. 24 Ω, then conduction losses worse case are:

$$P_{\text{cond}} = I_{\text{d,rms}}^2 R_{\text{DS(on)}} = 570 \text{ mW}$$

7. Off-time and on-time switching losses can be estimated based on the following calculations:

$$P_{\text{off}} = \frac{I_{\text{peak}}(V_{\text{bulk}} + V_{\text{clamp}})t_{\text{off}}}{2T_{\text{sw}}}$$

$$= \frac{0.335 \times (127 + 120 \cdot 2) \times 10\text{n}}{2 \times 15.4\mu} \quad (\text{eq. 7})$$

$$= 36 \text{ mW}$$

Where, assume the  $V_{\text{clamp}}$  is equal to two times of reflected voltage.

$$P_{\text{on}} = \frac{I_{\text{valley}}(V_{\text{bulk}} + N(V_{\text{out}} + V_f))t_{\text{on}}}{6T_{\text{sw}}}$$

$$= \frac{0.111 \times (127 + 100) \times 20\text{n}}{6 \times 15.4\mu} \quad (\text{eq. 8})$$

$$= 5.5 \text{ mW}$$

It is noted that the overlap of voltage and current seen on MOSFET during turning on and off duration is dependent on the snubber and parasitic capacitance seen from drain pin. Therefore the  $t_{\text{off}}$  and  $t_{\text{on}}$  in Equations 7 and 8 have to be modified after measuring on the bench.

8. The theoretical total power is then 0.570 + 0.036 + 0.0055 = 611 mW
9. If the NCP107X operates at DSS mode, then the losses caused by DSS mode should be counted as losses of this device on the following calculation:

$$P_{\text{DSS}} = I_{\text{CC1}} \cdot V_{\text{in,max}} = 1\text{m} \cdot 375 = 375 \text{ mW} \quad (\text{eq. 9})$$

### MOSFET protection

As in any Flyback design, it is important to limit the drain excursion to a safe value, e.g. below the MOSFET  $\text{BV}_{\text{dss}}$  which is 700 V. Figure 37a, b, c present possible implementations:

## NCP1072, NCP1075



**Figure 37. Different Options to Clamp the Leakage Spike**

Figure 37a: the simple capacitor limits the voltage according to The lateral MOSFET body–diode shall never be forward biased, either during start–up (because of a large leakage inductance) or in normal operation as shown by Figure 35. This condition sets the maximum voltage that can be reflected during  $t_{off}$ . As a result, the Flyback voltage which is reflected on the drain at the switch opening cannot be larger than the input voltage. When selecting components, you thus must adopt a turn ratio which adheres to the following equation: Equation 3. This option is only valid for low power applications, e.g. below 5 W, otherwise chances exist to destroy the MOSFET. After evaluating the leakage inductance, you can compute C with Equation 4. Typical values are between 100 pF and up to 470 pF. Large capacitors increase capacitive losses...

Figure 37b: the most standard circuitry is called the RCD network. You calculate  $R_{clamp}$  and  $C_{clamp}$  using the following formulae:

$$R_{clamp} = \frac{2 V_{clamp} (V_{clamp} - (V_{out} + V_f)N)}{L_{leak} I_{peak}^2 F_{sw}} \quad (\text{eq. 10})$$

$$C_{clamp} = \frac{V_{clamp}}{V_{ripple} F_{sw} R_{clamp}} \quad (\text{eq. 11})$$

$V_{clamp}$  is usually selected 50–80 V above the reflected value  $N \times (V_{out} + V_f)$ . The diode needs to be a fast one and a MUR160 represents a good choice. One major drawback of the RCD network lies in its dependency upon the peak current. Worst case occurs when  $I_{peak}$  and  $V_{in}$  are maximum and  $V_{out}$  is close to reach the steady–state value.

Figure 37c: this option is probably the most expensive of all three but it offers the best protection degree. If you need a very precise clamping level, you must implement a zener diode or a TVS. There are little technology differences

behind a standard zener diode and a TVS. However, the die area is far bigger for a transient suppressor than that of zener. A 5 W zener diode like the 1N5388B will accept 180 W peak power if it lasts less than 8.3 ms. If the peak current in the worse case (e.g. when the PWM circuit maximum current limit works) multiplied by the nominal zener voltage exceeds these 180 W, then the diode will be destroyed when the supply experiences overloads. A transient suppressor like the P6KE200 still dissipates 5 W of continuous power but is able to accept surges up to 600 W @ 1 ms. Select the zener or TVS clamping level between 40 to 80 V above the reflected output voltage when the supply is heavily loaded.

### Power Dissipation and Heatsinking

The NCP107X welcomes two dissipating terms, the DSS current–source (when active) and the MOSFET. Thus,  $P_{tot} = P_{DSS} + P_{MOSFET}$ . It is mandatory to properly manage the heat generated by losses. If no precaution is taken, risks exist to trigger the internal thermal shutdown (TSD). To help dissipating the heat, the PCB designer must foresee large copper areas around the package. Take the PDIP–7 package as an example, when surrounded by a surface greater than 1.0 cm<sup>2</sup> of 35 μm copper, it becomes possible to drop its thermal resistance junction–to–ambient,  $R_{\theta JA}$  down to 75°C/W and thus dissipate more power. The maximum power the device can thus evacuate is:

$$P_{max} = \frac{T_{Jmax} - T_{ambmax}}{R_{\theta JA}} \quad (\text{eq. 12})$$

which gives around 930 mW for an ambient of 50°C and a maximum junction of 120°C. If the surface is not large enough, assuming the  $R_{\theta JA}$  is 100°C/W, then the maximum power the device can evacuate becomes 700 mW. Figure 38 gives a possible layout to help drop the thermal resistance.

## NCP1072, NCP1075



Figure 38. A Possible PCB Arrangement to Reduce the Thermal Resistance Junction-to-Ambient

### A 10 W NCP1075 based Flyback Converter Featuring Low Standby Power

Figure 40 depicts a typical application showing a NCP1075–65 kHz operating in a 10 W converter. To leave more room for the MOSFET, it is recommended to disable the DSS by shorting the J3. In this application, the feedback

is made via a NCP431 whose low bias current (50  $\mu$ A) helps to lower the no load standby power.

Measurements have been taken from a demonstration board implementing the diagram in Figure 40 and the following results were achieved with auxiliary winding to bias the device:

	100 Vac	115 Vac	230 Vac	265 Vac
No load consumption with auxiliary winding	26 mW	28 mW	38 mW	45 mW



Figure 39. V<sub>out</sub> = 12 V

## NCP1072, NCP1075



**Figure 40. A 12 V – 0.85 A Universal Mains Power Supply**

### ORDERING INFORMATION

Device	Frequency	Package Type	Shipping	Rds(on) ohm	Ipk (mA)
NCP1072STAT3G	65 kHz	SOT-223	4000 / Tape & Reel	11	250
NCP1072STBT3G	100 kHz	SOT-223	4000 / Tape & Reel	11	250
NCP1072P65G	65 kHz	PDIP-7	50 Units / Rail	11	250
NCP1072P100G	100 kHz	PDIP-7	50 Units / Rail	11	250
NCP1075STAT3G	65 kHz	SOT-223	4000 / Tape & Reel	11	450
NCP1075STBT3G	100 kHz	SOT-223	4000 / Tape & Reel	11	450
NCP1075STCT3G	130 kHz	SOT-223	4000 / Tape & Reel	11	450
NCP1075P65G	65 kHz	PDIP-7	50 Units / Rail	11	450
NCP1075P100G	100 kHz	PDIP-7	50 Units / Rail	11	450
NCP1075P130G	130 kHz	PDIP-7	50 Units / Rail	11	450

†For information on tape and reel specifications, including part orientation and tape sizes, please refer to our Tape and Reel Packaging Specifications Brochure, BRD8011/D.



# NCP1072, NCP1075

## PACKAGE DIMENSIONS

SOT-223 (TO-261)  
CASE 318E-04  
ISSUE N



NOTES:  
1. DIMENSIONING AND TOLERANCING PER ASME Y14.5M, 1994.  
2. CONTROLLING DIMENSION: INCH.

DIM	MILLIMETERS			INCHES		
	MIN	NOM	MAX	MIN	NOM	MAX
A	1.50	1.63	1.75	0.060	0.064	0.068
A1	0.02	0.06	0.10	0.001	0.002	0.004
b	0.60	0.75	0.89	0.024	0.030	0.035
b1	2.90	3.06	3.20	0.115	0.121	0.126
c	0.24	0.29	0.35	0.009	0.012	0.014
D	6.30	6.50	6.70	0.249	0.256	0.263
E	3.30	3.50	3.70	0.130	0.138	0.145
e	2.20	2.30	2.40	0.087	0.091	0.094
e1	0.85	0.94	1.05	0.033	0.037	0.041
L	0.20	---	---	0.008	---	---
L1	1.50	1.75	2.00	0.060	0.069	0.078
HE	6.70	7.00	7.30	0.264	0.276	0.287
$\theta$	0°	---	10°	0°	---	10°

### SOLDERING FOOTPRINT\*



\*For additional information on our Pb-Free strategy and soldering details, please download the ON Semiconductor Soldering and Mounting Techniques Reference Manual, SOLDERRM/D.

# NCP1072, NCP1075

## PACKAGE DIMENSIONS

### 8 LEAD PDIP CASE 626A ISSUE A



NOTES:

1. DIMENSIONING AND TOLERANCING PER ANSI Y14.5M, 1982.
2. CONTROLLING DIMENSION: MILLIMETER.
3. PACKAGE CONTOUR OPTIONAL (ROUND OR SQUARE CORNERS).
4. DIMENSION L TO CENTER OF LEAD WHEN FORMED PARALLEL.
5. DIMENSIONS A AND B ARE DATUMS.

DIM	MILLIMETERS		INCHES	
	MIN	MAX	MIN	MAX
A	9.40	10.16	0.370	0.400
B	6.10	6.60	0.240	0.260
C	3.94	4.45	0.155	0.175
D	0.38	0.51	0.015	0.020
F	1.02	1.78	0.040	0.070
G	2.54 BSC		0.100 BSC	
H	0.76	1.27	0.030	0.050
J	0.20	0.30	0.008	0.012
K	2.92	3.43	0.115	0.135
L	7.62 BSC		0.300 BSC	
M	---	10°	---	10°
N	0.76	1.01	0.030	0.040

**ON Semiconductor** and **ON** are registered trademarks of Semiconductor Components Industries, LLC (SCILLC). SCILLC reserves the right to make changes without further notice to any products herein. SCILLC makes no warranty, representation or guarantee regarding the suitability of its products for any particular purpose, nor does SCILLC assume any liability arising out of the application or use of any product or circuit, and specifically disclaims any and all liability, including without limitation special, consequential or incidental damages. "Typical" parameters which may be provided in SCILLC data sheets and/or specifications can and do vary in different applications and actual performance may vary over time. All operating parameters, including "Typicals" must be validated for each customer application by customer's technical experts. SCILLC does not convey any license under its patent rights nor the rights of others. SCILLC products are not designed, intended, or authorized for use as components in systems intended for surgical implant into the body, or other applications intended to support or sustain life, or for any other application in which the failure of the SCILLC product could create a situation where personal injury or death may occur. Should Buyer purchase or use SCILLC products for any such unintended or unauthorized application, Buyer shall indemnify and hold SCILLC and its officers, employees, subsidiaries, affiliates, and distributors harmless against all claims, costs, damages, and expenses, and reasonable attorney fees arising out of, directly or indirectly, any claim of personal injury or death associated with such unintended or unauthorized use, even if such claim alleges that SCILLC was negligent regarding the design or manufacture of the part. SCILLC is an Equal Opportunity/Affirmative Action Employer. This literature is subject to all applicable copyright laws and is not for resale in any manner.

### PUBLICATION ORDERING INFORMATION

**LITERATURE FULFILLMENT:**  
Literature Distribution Center for ON Semiconductor  
P.O. Box 5163, Denver, Colorado 80217 USA  
**Phone:** 303-675-2175 or 800-344-3860 Toll Free USA/Canada  
**Fax:** 303-675-2176 or 800-344-3867 Toll Free USA/Canada  
**Email:** orderlit@onsemi.com

**N. American Technical Support:** 800-282-9855 Toll Free  
USA/Canada  
**Europe, Middle East and Africa Technical Support:**  
Phone: 421 33 790 2910  
**Japan Customer Focus Center**  
Phone: 81-3-5817-1050

**ON Semiconductor Website:** [www.onsemi.com](http://www.onsemi.com)  
**Order Literature:** <http://www.onsemi.com/orderlit>  
For additional information, please contact your local Sales Representative



## Стандарт Электрон Связь

Мы молодая и активно развивающаяся компания в области поставок электронных компонентов. Мы поставляем электронные компоненты отечественного и импортного производства напрямую от производителей и с крупнейших складов мира.

Благодаря сотрудничеству с мировыми поставщиками мы осуществляем комплексные и плановые поставки широчайшего спектра электронных компонентов.

Собственная эффективная логистика и склад в обеспечивает надежную поставку продукции в точно указанные сроки по всей России.

Мы осуществляем техническую поддержку нашим клиентам и предпродажную проверку качества продукции. На все поставляемые продукты мы предоставляем гарантию .

Осуществляем поставки продукции под контролем ВП МО РФ на предприятия военно-промышленного комплекса России , а также работаем в рамках 275 ФЗ с открытием отдельных счетов в уполномоченном банке. Система менеджмента качества компании соответствует требованиям ГОСТ ISO 9001.

Минимальные сроки поставки, гибкие цены, неограниченный ассортимент и индивидуальный подход к клиентам являются основой для выстраивания долгосрочного и эффективного сотрудничества с предприятиями радиоэлектронной промышленности, предприятиями ВПК и научно-исследовательскими институтами России.

С нами вы становитесь еще успешнее!

### Наши контакты:

**Телефон:** +7 812 627 14 35

**Электронная почта:** [sales@st-electron.ru](mailto:sales@st-electron.ru)

**Адрес:** 198099, Санкт-Петербург,  
Промышленная ул, дом № 19, литера Н,  
помещение 100-Н Офис 331