

# Precision, Micropower, Single Supply Instrumentation Amplifier (Fixed Gain = 10 or 100)

## FEATURES

- Gain Error: 0.04% Max
- Gain Nonlinearity: 0.0008% (8ppm) Max
- Gain Drift: 4ppm/°C Max
- Supply Current: 105μA Max
- Offset Voltage: 160μV Max
- Offset Voltage Drift: 0.4μV/°C Typ
- Offset Current: 600pA Max
- CMRR, G = 100: 100dB Min
- 0.1Hz to 10Hz Noise: 0.9μVp-p Typ  
2.3pAp-p Typ
- Gain Bandwidth Product: 250kHz Min
- Single or Dual Supply Operation
- Surface Mount Package Available

## APPLICATIONS

- Differential Signal Amplification in Presence of Common Mode Voltage
- Micropower Bridge Transducer Amplifier
  - Thermocouples
  - Strain Gauges
  - Thermistors
- Differential Voltage-to-Current Converter
- Transformer Coupled Amplifier
- 4mA to 20mA Bridge Transmitter

LT, LTC and LT are registered trademarks of Linear Technology Corporation.

## DESCRIPTION

The LT<sup>®</sup>1101 establishes the following milestones: (1) It is the first micropower instrumentation amplifier, (2) It is the first single supply instrumentation amplifier, (3) It is the first instrumentation amplifier to feature fixed gains of 10 and/or 100 in low cost, space-saving 8-lead packages.

The LT1101 is completely self-contained: no external gain setting resistor is required. The LT1101 combines its micropower operation (75μA supply current) with a gain error of 0.008%, gain linearity of 3ppm, gain drift of 1ppm/°C. The output is guaranteed to drive a 2k load to ±10V with excellent gain accuracy.

Other precision specifications are also outstanding: 50μV input offset voltage, 130pA input offset current, and low drift (0.4μV/°C and 0.7pA/°C). In addition, unlike other instrumentation amplifiers, there is no output offset voltage contribution to total error.

A full set of specifications are provided with ±15V dual supplies and for single 5V supply operation. The LT1101 can be operated from a single lithium cell or two Ni-Cad batteries. Battery voltage can drop as low as 1.8V, yet the LT1101 still maintains its gain accuracy. In single supply applications, both input and output voltages swing to within a few millivolts of ground. The output sinks current while swinging to ground—no external, power consuming pull down resistors are needed.

## TYPICAL APPLICATION



Gain Error Distribution

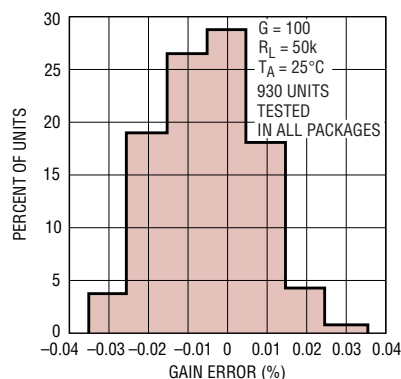

# LT1101

## ABSOLUTE MAXIMUM RATINGS (Note 1)

Supply Voltage .....  $\pm 22V$   
 Differential Input Voltage .....  $\pm 36V$   
 Input Voltage ..... Equal to Positive Supply Voltage  
 ..... 10V Below Negative Supply Voltage  
 Output Short Circuit Duration ..... Indefinite

Operating Temperature Range

LT1101AM/LT1101M (**OBSOLETE**) ...  $-55^{\circ}C$  to  $125^{\circ}C$

LT1101AI/LT1101I .....  $-40^{\circ}C$  to  $85^{\circ}C$

LT1101AC/LT1101C .....  $0^{\circ}C$  to  $70^{\circ}C$

Storage Temperature Range .....  $-65^{\circ}C$  to  $150^{\circ}C$

Lead Temperature (Soldering, 10 sec) .....  $300^{\circ}C$

## PACKAGE/ORDER INFORMATION

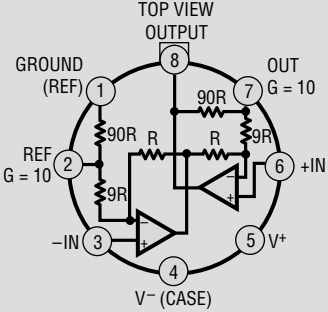
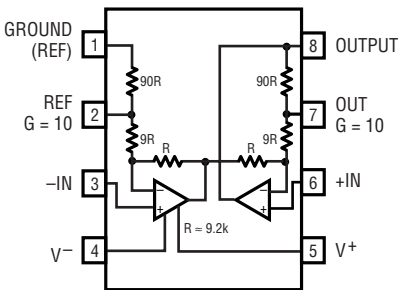
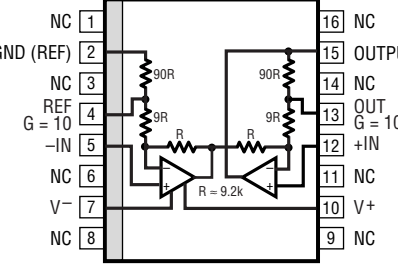
 <p>H PACKAGE 8-LEAD TO-5 METAL CAN <math>T_{JMAX} = 150^{\circ}C, \theta_{JA} = 150^{\circ}C/W, \theta_{JC} = 45^{\circ}C/W</math></p>	 <p>N PACKAGE 8-LEAD PDIP <math>T_{JMAX} = 150^{\circ}C, \theta_{JA} = 130^{\circ}C/W</math> J PACKAGE 8-LEAD CERDIP <math>T_{JMAX} = 150^{\circ}C, \theta_{JA} = 100^{\circ}C/W</math></p>	 <p>SW PACKAGE 16-LEAD PLASTIC SO <math>T_{JMAX} = 150^{\circ}C, \theta_{JA} = 100^{\circ}C/W</math></p>	
ORDER PART NUMBER	ORDER PART NUMBER		ORDER PART NUMBER
LT1101AMH LT1101MH LT1101ACH LT1101CH	LT1101AMJ8 LT1101MJ8 LT1101ACJ8 LT1101CJ8	LT1101AIN8 LT1101IN8 LT1101ACN8 LT1101CN8	LT1101SW LT1101ISW
<b>OBSOLETE PACKAGES</b> Consider the N8 as an Alternate Source			

Consult LTC Marketing for parts specified with wider operating temperature ranges.

## ELECTRICAL CHARACTERISTICS

$V_S = 5V, 0V, V_{CM} = 0.1V, V_{REF(PIN 1)} = 0.1V, G = 10$  or  $100, T_A = 25^{\circ}C$ , unless otherwise noted. (Note 4)

SYMBOL	PARAMETER	CONDITIONS	LT1101AM/AI/AC			LT1101M/I/C			UNITS
			MIN	TYP	MAX	MIN	TYP	MAX	
$G_E$	Gain Error	$G = 100, V_0 = 0.1V$ to $3.5V, R_L = 50k$		0.010	0.050		0.011	0.075	%
		$G = 10, V_0 = 0.1V$ to $3.5V, R_L = 50k$		0009	0.040		0.010	0.060	%
$G_{NL}$	Gain Nonlinearity	$G = 100, R_L = 50k$		20	60		20	75	ppm
		$G = 10, R_L = 50k$ (Note 2)		3	7		3	8	ppm
$V_{OS}$	Input Offset Voltage			50	160		60	220	$\mu V$
		LT1101SW					250	600	$\mu V$
$I_{OS}$	Input Offset Current			0.13	0.60		0.15	0.90	nA
$I_B$	Input Bias Current			6	8		6	10	nA
$I_S$	Supply Current			75	105		78	120	$\mu A$

1101fa

**ELECTRICAL CHARACTERISTICS**  $V_S = 5V, 0V, V_{CM} = 0.1V, V_{REF(PIN 1)} = 0.1V, G = 10$  or  $100, T_A = 25^\circ C$ , unless otherwise noted. (Note 4)

SYMBOL	PARAMETER	CONDITIONS	LT1101AM/AI/AC			LT1101M/I/C			UNITS
			MIN	TYP	MAX	MIN	TYP	MAX	
CMRR	Common Mode Rejection Ratio	1k Source Imbalance	95	106		92	105		dB
		$G = 100, V_{CM} = 0.07V$ to $3.4V$ $G = 10, V_{CM} = 0.07V$ to $3.1V$	84	100		82	99		dB
	Minimum Supply Voltage	(Note 5)		1.8	2.3		1.8	2.3	V
$V_O$	Maximum Output Voltage Swing	Output High, 50k to GND	4.1	4.3		4.1	4.3		V
		Output High, 2k to GND	3.5	3.9		3.5	3.9		V
		Output Low, $V_{REF} = 0$ , No Load		3.3	6		3.3	6	mV
		Output Low, $V_{REF} = 0$ , 2k to GND		0.5	1		0.5	1	mV
		Output Low, $V_{REF} = 0, I_{SINK} = 100\mu A$		90	130		90	130	mV
BW	Bandwidth	$G = 100$ (Note 2)	2.0	3.0		2.0	3.0		kHz
		$G = 10$ (Note 2)	22	33		22	33		kHz
SR	Slew Rate	(Note 2)	0.04	0.07		0.04	0.07		V/ $\mu s$

$V_S = \pm 15V, V_{CM} = 0V, T_A = 25^\circ C$ , Gain = 10 or 100, unless otherwise noted.

SYMBOL	PARAMETER	CONDITIONS	LT1101AM/AI/AC			LT1101M/I/C			UNITS
			MIN	TYP	MAX	MIN	TYP	MAX	
$G_E$	Gain Error	$G = 100, V_O = \pm 10V, R_L = 50k$		0.008	0.040		0.009	0.060	%
		$G = 100, V_O = \pm 10V, R_L = 2k$		0.011	0.055		0.012	0.070	%
		$G = 100, V_O = \pm 10V, R_L = 50k$ or $2k$		0.008	0.040		0.009	0.060	%
$G_{NL}$	Gain Nonlinearity	$G = 100, R_L = 50k$		7	16		8	20	ppm
		$G = 100, R_L = 2k$		24	45		25	60	ppm
		$G = 10, R_L = 50k$ or $2k$		3	8		3	9	ppm
$V_{OS}$	Input Offset Voltage	LT1101SW		50	160		60	220	$\mu V$
							250	600	$\mu V$
$I_{OS}$	Input Offset Current			0.13	0.60		0.15	0.90	nA
$I_B$	Input Bias Current			6	8		6	10	nA
		Input Resistance Common Mode Differential Mode	(Note 2) (Note 2)	4 7	7 12		3 5	7 12	$G\Omega$ $G\Omega$
$e_n$	Input Noise Voltage	0.1Hz to 10Hz (Note 3)		0.9	1.8		0.9		$\mu V_{p-p}$
		Input Noise Voltage Density $f_0 = 10Hz$ (Note 3) $f_0 = 1000Hz$ (Note 3)		45 43	64 54		45 43		$nV/\sqrt{Hz}$ $nV/\sqrt{Hz}$
$i_n$	Input Noise Current	0.1Hz to 10Hz (Note 3)		2.3	4.0		2.3		$pA_{p-p}$
		Input Noise Current Density $f_0 = 10Hz$ (Note 3) $f_0 = 1000Hz$		0.06 0.02	0.10		0.06 0.02		$pA/\sqrt{Hz}$ $pA/\sqrt{Hz}$
	Input Voltage Range	$G = 100$	13.0	13.8		13.0	13.8		V
			-14.4	-14.7		-14.4	-14.7		V
		$G = 10$	11.5	12.5		11.5	12.5		V
			-13.0	-13.3		-13.0	-13.3		V
CMRR	Common Mode Rejection Ratio	1k Source Imbalance	100	112		98	112		dB
		$G = 100$ , Over CM Range $G = 10$ , Over CM Range	84	100		82	99		dB
PSRR	Power Supply Rejection Ratio	$V_S = +2.2V, -0.1V$ to $\pm 18V$	102	114		100	114		dB
$I_S$	Supply Current			92	130		94	150	$\mu A$

1101fa

## ELECTRICAL CHARACTERISTICS $V_S = \pm 15V$ , $V_{CM} = 0V$ , $T_A = 25^\circ C$ , Gain = 10 or 100, unless otherwise noted.

SYMBOL	PARAMETER	CONDITIONS	LT1101AM/AI			LT1101M/I			UNITS
			MIN	TYP	MAX	MIN	TYP	MAX	
$V_O$	Maximum Output Voltage Swing	$R_L = 50k$ $R_L = 2k$	13.0 11.0	14.2 13.2		13.0 11.0	14.2 13.2		V V
BW	Bandwidth	G = 100 (Note 2) G = 10 (Note 2)	2.3 25	3.5 37		2.3 25	3.5 37		kHz kHz
SR	Slew Rate		0.06	0.10		0.06	0.10		V/ $\mu s$

## ELECTRICAL CHARACTERISTICS $V_S = \pm 15V$ , $V_{CM} = 0V$ , Gain = 10 or 100, $-55^\circ C \leq T_A \leq 125^\circ C$ for AM/M grades, $-40^\circ C \leq T_A \leq 85^\circ C$ for AI/I grades, unless otherwise noted.

SYMBOL	PARAMETER	CONDITIONS	LT1101AM/AI			LT1101M/I			UNITS
			MIN	TYP	MAX	MIN	TYP	MAX	
$G_E$	Gain Error	G = 100, $V_O = \pm 10V$ , $R_L = 50k$ G = 100, $V_O = \pm 10V$ , $R_L = 5k$ G = 10, $V_O = \pm 10V$ , $R_L = 50k$ or $5k$		0.024 0.030 0.015	0.070 0.100 0.070		0.026 0.035 0.018	0.100 0.130 0.100	% % %
$TCG_E$	Gain Error Drift (Note 2)	G = 100, $R_L = 50k$ G = 100, $R_L = 5k$ G = 10, $R_L = 50k$ or $5k$		2 2 1	4 7 4		2 2 1	5 8 5	ppm/ $^\circ C$ ppm/ $^\circ C$ ppm/ $^\circ C$
$G_{NL}$	Gain Nonlinearity	G = 100, $R_L = 50k$ G = 100, $R_L = 5k$ G = 10, $R_L = 50k$ G = 10, $R_L = 5k$		24 70 4 10	70 300 13 40		26 75 5 12	90 500 15 60	ppm ppm ppm ppm
$V_{OS}$	Input Offset Voltage	LT1101ISW		90	350		110 110	500 950	$\mu V$ $\mu V$
$\Delta V_{OS}/\Delta T$	Input Offset Voltage Drift	(Note 2) LT1101ISW		0.4	2.0		0.5 0.5	2.8 4.8	$\mu V/^\circ C$ mV/ $^\circ C$
$I_{OS}$	Input Offset Current			0.16	0.80		0.19	1.30	nA
$\Delta I_{OS}/\Delta T$	Input Offset Current Drift	(Note 2)		0.5	4.0		0.8	7.0	pA/ $^\circ C$
$I_B$	Input Bias Current			7	10		7	12	nA
$\Delta I_B/\Delta T$	Input Bias Current Drift	(Note 2)		10	25		10	30	pA/ $^\circ C$
CMRR	Common Mode Rejection Ratio	G = 100, $V_{CM} = -14.4V$ to $13V$ G = 100, $V_{CM} = -13V$ to $11.5V$	96 80	111 99		94 78	111 98		dB dB
PSRR	Power Supply Rejection Ratio	$V_S = 3.0$ , $-0.1V$ to $\pm 18V$	98	110		94	110		dB
$I_S$	Supply Current			105	165		108	190	$\mu A$
$V_O$	Maximum Output Voltage Swing	$R_L = 50k$ $R_L = 5k$	12.5 11.0	14.0 13.5		12.5 11.0	14.0 13.5		V V

**ELECTRICAL CHARACTERISTICS**  $V_S = \pm 15V$ ,  $V_{CM} = 0V$ , Gain = 10 or 100,  $0^\circ C \leq T_A \leq 70^\circ C$ , unless otherwise noted.

SYMBOL	PARAMETER	CONDITIONS	LT1101AC			LT1101C/S			UNITS
			MIN	TYP	MAX	MIN	TYP	MAX	
G <sub>E</sub>	Gain Error	G = 100, V <sub>O</sub> = ±10V, R <sub>L</sub> = 50k		0.012	0.055		0.014	0.080	%
		G = 100, V <sub>O</sub> = ±10V, R <sub>L</sub> = 2k		0.018	0.085		0.020	0.100	%
		G = 10, V <sub>O</sub> = ±10V, R <sub>L</sub> = 50k or 2k		0.009	0.055		0.010	0.080	%
TCG <sub>E</sub>	Gain Error Drift (Note 2)	G = 100, R <sub>L</sub> = 50k		1	4		1	5	ppm/°C
		G = 100, R <sub>L</sub> = 2k		2	7		2	9	ppm/°C
		G = 10, R <sub>L</sub> = 50k or 5k		1	4		1	5	ppm/°C
G <sub>NL</sub>	Gain Nonlinearity	G = 100, R <sub>L</sub> = 50k		9	25		10	35	ppm
		G = 100, R <sub>L</sub> = 2k		33	75		36	100	ppm
		G = 10, R <sub>L</sub> = 50k or 2k		4	10		4	11	ppm
V <sub>OS</sub>	Input Offset Voltage			70	250		85	350	μV
		LT1101SW					300	800	μV
ΔV <sub>OS</sub> /ΔT	Input Offset Voltage Drift	(Note 2)		0.4	2.0		0.5	2.8	μV/°C
		LT1101SW					1.2	4.5	μV/°C
I <sub>OS</sub>	Input Offset Current			0.14	0.70		0.17	1.10	nA
ΔI <sub>OS</sub> /ΔT	Input Offset Current Drift	(Note 2)		0.5	4.0		0.8	7.0	pA/°C
I <sub>B</sub>	Input Bias Current			6	9		6	11	nA
ΔI <sub>B</sub> /ΔT	Input Bias Current Drift	(Note 2)		10	25		10	30	pA/°C
CMRR	Common Mode Rejection Ratio	G = 100, V <sub>CM</sub> = -14.4V to 13V	98	112		96	112		dB
		G = 100, V <sub>CM</sub> = -13V to 11.5V	82	100		80	99		dB
PSRR	Power Supply Rejection Ratio	V <sub>S</sub> = 2.5, -0.1V to ±18V	100	112		97	112		dB
I <sub>S</sub>	Supply Current			98	148		100	170	μA
V <sub>O</sub>	Maximum Output Voltage Swing	R <sub>L</sub> = 50k	±12.5	±14.1		±12.5	±14.1		V
		R <sub>L</sub> = 2k	±10.5	±13.0		±10.5	±13.0		V

## ELECTRICAL CHARACTERISTICS

$V_S = 5V, 0V, V_{CM} = 0.1V, V_{REF(PIN\ 1)} = 0.1V, \text{Gain} = 10 \text{ or } 100,$   
 $-40^\circ\text{C} \leq T_A \leq 85^\circ\text{C}$  for Al/I grades, unless otherwise noted (Note 4).

SYMBOL	PARAMETER	CONDITIONS	LT1101AM/AI			LT1101M/I			UNITS	
			MIN	TYP	MAX	MIN	TYP	MAX		
G <sub>E</sub>	Gain Error	G = 100, V <sub>0</sub> = 0.1V to 3.5V, R <sub>L</sub> = 50k		0.026	0.080		0.028	0.120	%	
		G = 10, V <sub>CM</sub> = 0.15, R <sub>L</sub> = 50k		0.011	0.070		0.014	0.100	%	
TCG <sub>E</sub>	Gain Error Drift	R <sub>L</sub> = 50k (Note 2)		1	4		1	5	ppm/°C	
G <sub>NL</sub>	Gain Nonlinearity	G = 100, R <sub>L</sub> = 50k		45	110		48	140	ppm	
		G = 10, R <sub>L</sub> = 50k (Note 2)		4	13		5	15	ppm	
V <sub>OS</sub>	Input Offset Voltage	LT1101ISW		90	350		110	500	μV	
							110	950	μV	
ΔV <sub>OS</sub> /ΔT	Input Offset Voltage Drift	(Note 2) LT1101ISW		0.4	2.0		0.5	2.8	μV/°C	
							0.5	4.8	μV/°C	
I <sub>OS</sub>	Input Offset Current			0.16	0.80		0.19	1.30	nA	
ΔV <sub>OS</sub> /ΔT	Input Offset Current Drift	(Note 2)		0.5	4.0		0.8	7.0	pA/°C	
I <sub>B</sub>	Input Bias Current			7	10		7	12	nA	
ΔI <sub>B</sub> /ΔT	Input Bias Current Drift	(Note 2)		10	25		10	30	pA/°C	
CMRR	Common Mode Rejection Ratio	G = 100, V <sub>CM</sub> = 0.1V to 3.2V	91	105		88	104		dB	
		G = 10, V <sub>CM</sub> = 0.1V to 2.9V, V <sub>REF</sub> = 0.15V	80	98		77	97		dB	
I <sub>S</sub>	Supply Current			88	135		92	160	μA	
V <sub>0</sub>	Maximum Output Voltage Swing	Output High, 50k to GND	3.8	4.1		3.8	4.1		V	
		Output High, 2k to GND	3.0	3.7		3.0	3.7		V	
		Output Low, V <sub>REF</sub> = 0, No Load		4.5	8		4.5	8		mV
		Output Low, V <sub>REF</sub> = 0, 2k to GND		0.7	1.5		0.7	1.5		mV
		Output Low, V <sub>REF</sub> = 0, I <sub>SINK</sub> = 100μA		125	170		125	170		mV

**ELECTRICAL CHARACTERISTICS**  $V_S = 5V, 0V, V_{CM} = 0.1V, V_{REF(PIN 1)} = 0.1V, \text{Gain} = 10 \text{ or } 100,$   
 $0^\circ\text{C} \leq T_A \leq 70^\circ\text{C},$  unless otherwise noted (Note 4).

SYMBOL	PARAMETER	CONDITIONS	LT1101AC			LT1101C/S			UNITS
			MIN	TYP	MAX	MIN	TYP	MAX	
G <sub>E</sub>	Gain Error	G = 100, V <sub>O</sub> = 0.1V to 3.5V, R <sub>L</sub> = 50k		0.017	0.065		0.018	0.095	%
		G = 10, V <sub>CM</sub> = 0.15V, R <sub>L</sub> = 50k		0.010	0.060		0.012	0.080	%
TCG <sub>E</sub>	Gain Error Drift	R <sub>L</sub> = 50k (Note 2)		1	4		1	5	ppm/°C
G <sub>NL</sub>	Gain Nonlinearity	G = 100, R <sub>L</sub> = 50k		25	80		25	100	ppm
		G = 10, R <sub>L</sub> = 50k (Note 2)		4	10		4	11	ppm
V <sub>OS</sub>	Input Offset Voltage	LT1101SW		70	250		85	350	μV
							300	800	μV
ΔV <sub>OS</sub> /ΔT	Input Offset Voltage Drift	(Note 2)		0.4	2.0		0.5	2.8	μV/°C
		LT1101SW					1.2	4.5	μV/°C
I <sub>OS</sub>	Input Offset Current			0.14	0.70		0.17	1.10	nA
ΔI <sub>OS</sub> /ΔT	Input Offset Current Drift	(Note 2)		0.5	4.0		0.8	7	pA/°C
I <sub>B</sub>	Input Bias Current			6	9		6	11	nA
ΔI <sub>B</sub> /ΔT	Input Bias Current Drift	(Note 2)		10	25		10	30	pA/°C
CMRR	Common Mode Rejection Ratio	G = 100, V <sub>CM</sub> = 0.07V to 3.3V	93	105		90	104		dB
		G = 10, V <sub>CM</sub> = 0.07V to 3V, V <sub>REF</sub> = 0.15V	82	99		80	98		dB
I <sub>S</sub>	Supply Current			80	120		85	145	μA
V <sub>O</sub>	Maximum Output Voltage Swing	Output High, 50k to GND	4.0	4.2		4.0	4.2		V
		Output High, 2k to GND	3.3	3.8		3.3	3.8		V
		Output Low, V <sub>REF</sub> = 0, No Load		4	7		4	7	mV
		Output Low, V <sub>REF</sub> = 0, 2k to GND		0.6	1.2		0.6	1.2	mV
		Output Low, V <sub>REF</sub> = 0, I <sub>SINK</sub> = 100μA		100	150		100	150	mV

**Note 1:** Absolute Maximum Ratings are those values beyond which the life of a device may be impaired.

**Note 2:** This parameter is not tested. It is guaranteed by design and by inference from other tests.

**Note 3:** This parameter is tested on a sample basis only.

**Note 4:** These test conditions are equivalent to V<sub>S</sub> = 4.9V, -0.1V, V<sub>CM</sub> = 0V, V<sub>REF(PIN1)</sub> = 0V.

**Note 5:** Minimum supply voltage is guaranteed by the power supply rejection test. The LT1101 actually works at 1.8V supply with minimal degradation in performance.

## TYPICAL PERFORMANCE CHARACTERISTICS

### Gain = 100 Nonlinearity Distribution



### Gain = 10 Nonlinearity Distribution



### Gain vs Frequency



### Gain Error Over Temperature



### Gain Nonlinearity Temperature

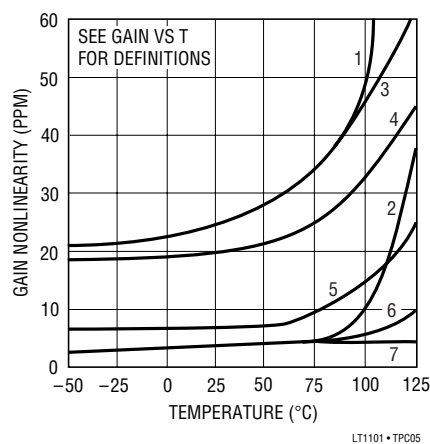

### Input Offset Voltage Distribution



### Supply Current vs Temperature

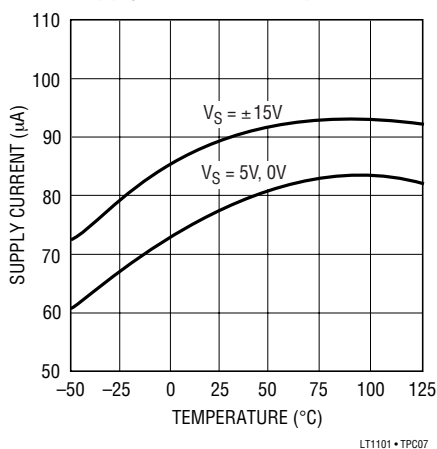

### Input Bias and Offset Currents vs Temperature

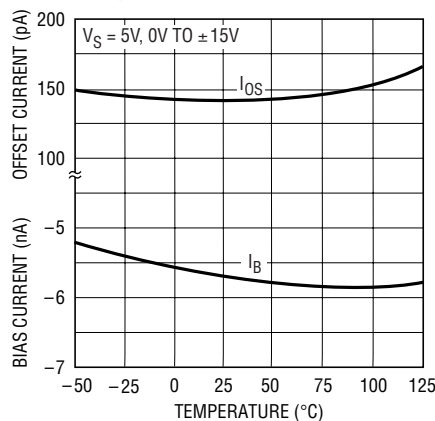

### Input Bias Current vs Common Mode Voltage

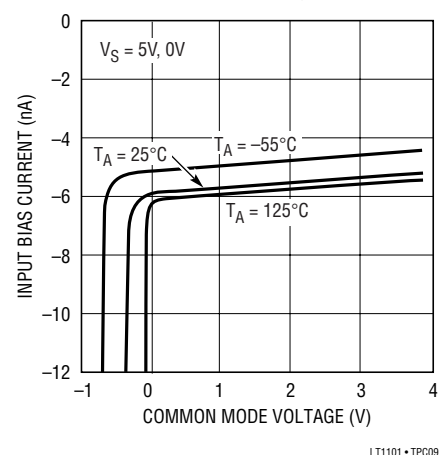



# TYPICAL PERFORMANCE CHARACTERISTICS

**Common Mode Rejection Ratio vs Frequency**



LT1101 • TPC10

**Common Mode Range vs Supply Voltage**



LT1101 • TPC11

**Power Supply Rejection Ratio vs Frequency**



LT1101 • TPC12

**Output Saturation vs Temperature vs Sink Current**



LT1101 • TPC13

**Output Voltage Swing vs Load Current**



LT1101 • TPC14

**Short-Circuit Current vs Time**



LT1101 • TPC15

**Capacitive Load Handling**



LT1101 • TPC16

**Undistorted Output Swing vs Frequency**



LT1101 • TPC17

**Output Impedance vs Frequency**



LT1101 • TPC18

**TYPICAL PERFORMANCE CHARACTERISTICS**

**Noise Spectrum**

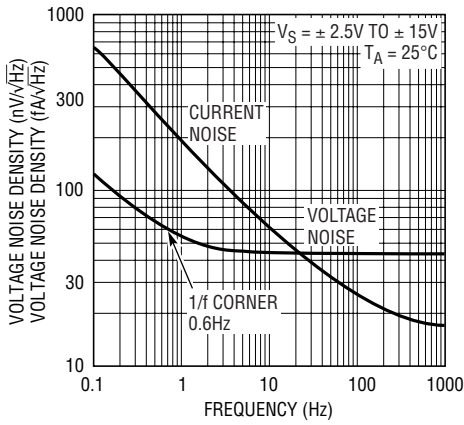

LT1101 • TPC19

**Warm-Up Drift**

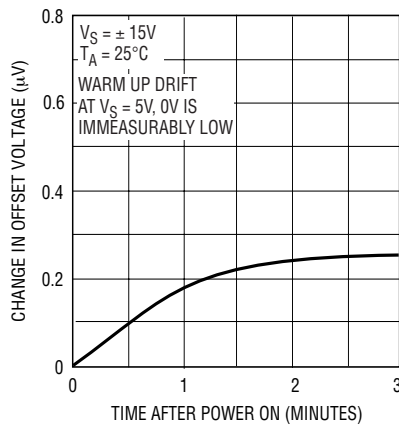

LT1101 • TPC20

**Large Signal Transient Response**  
 $G = 10, V_S = 5V, 0V$



LT1101 • TPC20.1

**Large Signal Transient Response**  
 $G = 10, V_S = 15V$

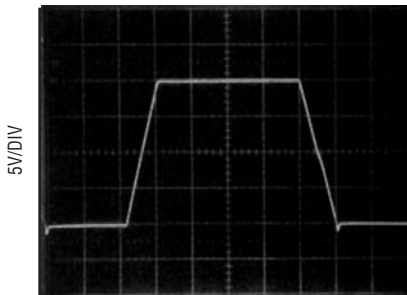

LT1101 • TPC20.2

**Large Signal Transient Response**  
 $G = 100, V_S = \pm 15V$

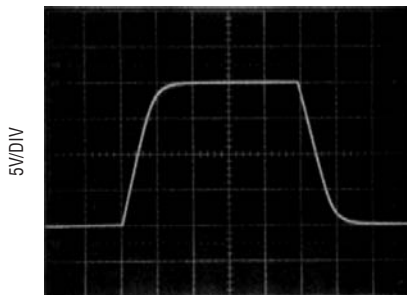

LT1101 • TPC20.3

**Large Signal Transient Response**  
 $G = 100, V_S = 5V, 0V$



LT1101 • TPC20.4

**Small Signal Transient Response**  
 $G = 10, V_S = 5V, 0V$

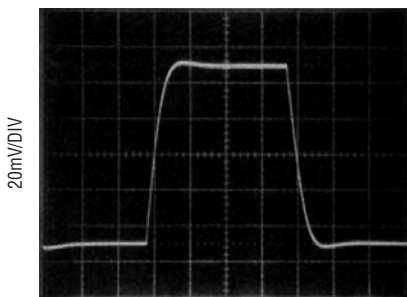

LT1101 • TPC20.5

**Small Signal Transient Response**  
 $G = 10, V_S = \pm 15V$

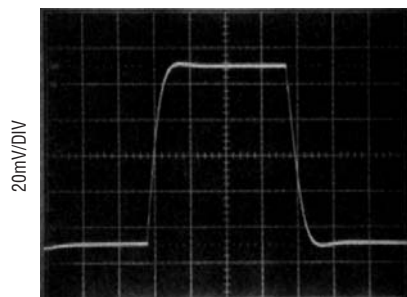

LT1101 • TPC20.6

**Small Signal Transient Response**  
 $G = 100, V_S = 5V, 0V$



LT1101 • TPC20.7

## TYPICAL PERFORMANCE CHARACTERISTICS

**Single Supply: Minimum Common Mode Voltage vs Output Voltage**



LT1101 • TPC21

**Single Supply: Minimum Output Voltage vs Common Mode Voltage**

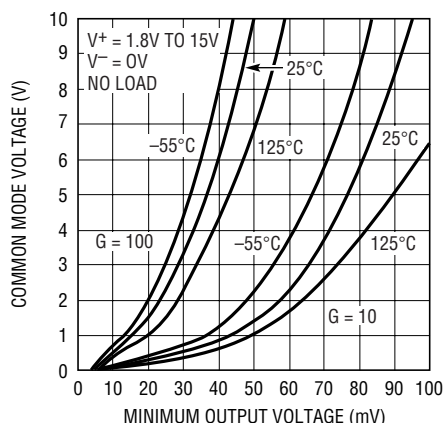

LT1101 • TPC22

**Minimum Supply Voltage vs Temperature**



LT1101 • TPC23

## APPLICATIONS INFORMATION

### Single Supply Applications

The LT1101 is the first instrumentation amplifier which is fully specified for single supply operation, (i.e. when the negative supply is 0V). Both the input common mode range and the output swing are within a few millivolts of ground.

Probably the most common application for instrumentation amplifiers is amplifying a differential signal from a transducer or sensor resistance bridge. All competitive instrumentation amplifiers have a minimum required common mode voltage which is 3V to 5V above the negative supply. This means that the voltage across the bridge has to be 6V to 10V or dual supplies have to be used (i.e., micropower) single battery usage is not attainable on competitive devices.

The minimum output voltage obtainable on the LT1101 is a function of the input common mode voltage. When the common mode voltage is high and the output is low, current will flow from the output of amplifier A into the output of amplifier B. See the Minimum Output Voltage vs Common Mode Voltage plot.

Similarly, the Single Supply Minimum Common Mode Voltage vs Output Voltage plot specifies the expected common mode range.

When the output is high and input common mode is low, the output of amplifier A has to sink current coming from the output of amplifier B. Since amplifier A is effectively in unity gain, its input is limited by its output.

### Common Mode Rejection vs Frequency

The common mode rejection ratio (CMRR) of the LT1101 starts to roll off at a relatively low frequency. However, as shown on the Common Mode Rejection Ratio vs Frequency plot, CMRR can be enhanced significantly by connecting an 82pF capacitor between pins 1 and 2. This improvement is only available in the gain 100 configuration, and it is in excess of 30dB at 60Hz.

### Offset Nulling

The LT1101 is not equipped with dedicated offset null terminals. In many bridge transducer or sensor applications, calibrating the bridge simultaneously eliminates the instrumentation amplifier's offset as a source of error. For example, in the Micropower Remote Temperature Sensor Application shown, one adjustment removes the offset errors due to the temperature sensor, voltage reference and the LT1101.

## APPLICATIONS INFORMATION

A simple resistive offset adjust procedure is shown below. If  $R = 5\Omega$  for  $G = 10$ , and  $R = 50\Omega$  for  $G = 100$ , then the effect of  $R$  on gain error is approximately 0.006%. Unfortunately, about  $450\mu\text{A}$  has to flow through  $R$  to bias the reference terminal (Pin 1) and to null out the worst-case offset voltage. The total current through the resistor network can exceed 1mA, and the micropower advantage of the LT1101 is lost.



Another offset adjust scheme uses the LT1077 micropower op amp to drive the reference Pin 1. Gain error and common mode rejection are unaffected, the total current increase is  $45\mu\text{A}$ . The offset of the LT1077 is trimmed and amplified to match and cancel the offset voltage of the LT1101. Output offset null range is  $\pm 25\text{mV}$ .



### Gains Between 10 and 100

Gains between 10 and 100 can be achieved by connecting two equal resistors ( $= R_x$ ) between Pins 1 and 2 and Pins 7 and 8.

$$\text{Gain} = 10 + \frac{R_x}{R + R_x/90}$$

The nominal value of  $R$  is  $9.2\text{k}\Omega$ . The usefulness of this method is limited by the fact that  $R$  is not controlled to better than  $\pm 10\%$  absolute accuracy in production. However, on any specific unit,  $90R$  can be measured between Pins 1 and 2.

### Input Protection

Instrumentation amplifiers are often used in harsh environments where overload conditions can occur. The LT1101 employs PNP input transistors, consequently the differential input voltage can be  $\pm 30\text{V}$  (with  $\pm 15\text{V}$  supplies,  $\pm 36\text{V}$  with  $\pm 18\text{V}$  supplies) without an increase in input bias current. Competitive instrumentation amplifiers have NPN inputs which are protected by back-to-back diodes. When the differential input voltage exceeds  $\pm 1.3\text{V}$  on these competitive devices, input current increases to the milliampere level; more than  $\pm 10\text{V}$  differential voltage can cause permanent damage.

When the LT1101's inputs are pulled above the positive supply, the inputs will clamp a diode voltage above the positive supply. No damage will occur if the input current is limited to 20mA.

$500\Omega$  resistors in series with the inputs protect the LT1101 when the inputs are pulled as much as 10V below the negative supply.

# APPLICATIONS INFORMATION

## Micropower, Battery Operated Remote Temperature Sensor



TRIM OUTPUT TO 250mV AT 25°C  
 TEMPERATURE RANGE = 2.5°C TO 150°C  
 ACCURACY = ±0.5°C

LT1101 • AI03

## 4mA to 20mA Loop Receiver



4mA TO 20mA IN – 0V TO 10V OUT  
 TRIM OUTPUT TO 5V AT 12mA IN

LT1101 • AI04

## Instrumentation Amplifier with ±150mA Output Current



GAIN = 10, DEGRADED BY 0.01% DUE TO LT1010  
 OUTPUT = ±10V INTO 75Ω (TO 1.5kHz)  
 DRIVES ANY CAPACITIVE LOAD  
 SINGLE SUPPLY APPLICATION (V+ = 5V, V- = 0V):  
 V<sub>OUT MIN</sub> = 120mV, V<sub>OUT MAX</sub> = 3.4V

LT1101 • AI05

## Voltage Controlled Current Source

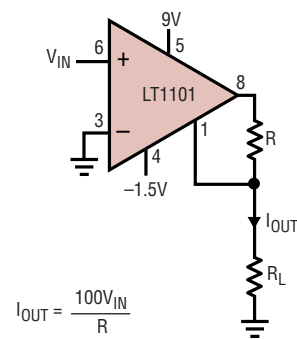

$$I_{OUT} = \frac{100V_{IN}}{R}$$

I<sub>OUT</sub> = 0mA TO 5mA  
 VOLTAGE COMPLIANCE = 6.4V  
 (R ≤ 200Ω)

LT1101 • AI06

APPLICATIONS INFORMATION

Differential Voltage Amplification from a Resistance Bridge



Gain = 20, 110 or 200 Instrumentation Amplifier

Differential Output



Single Ended Output



GAIN = 200, AS SHOWN  
 GAIN = 20, SHORT PIN 1 TO PIN 2, PIN 7 TO PIN 8  
 ON BOTH DEVICES  
 GAIN = 110, SHORT PIN 1 TO PIN 2, PIN 7 TO PIN 8  
 ON ONE DEVICE, NOT ON THE OTHER  
 INPUT REFERRED NOISE IS REDUCED BY  $\sqrt{2}$  (G = 200 OR 20)

LT1101 • A108

PACKAGE DESCRIPTION

**H Package**  
**8-Lead TO-5 Metal Can (.200 Inch PCD)**  
 (Reference LTC DWG # 05-08-1320)

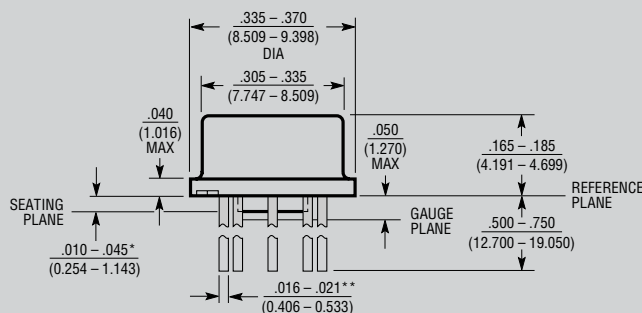

\* LEAD DIAMETER IS UNCONTROLLED BETWEEN THE REFERENCE PLANE AND THE SEATING PLANE

\*\* FOR SOLDER DIP LEAD FINISH, LEAD DIAMETER IS .016 - .024 (0.406 - 0.610) H8(TO-5) 0.200 PCD 0801

**J8 Package**  
**8-Lead Cerdip (Narrow .300 Inch, Hermetic)**  
 (Reference LTC DWG # 05-08-1110)

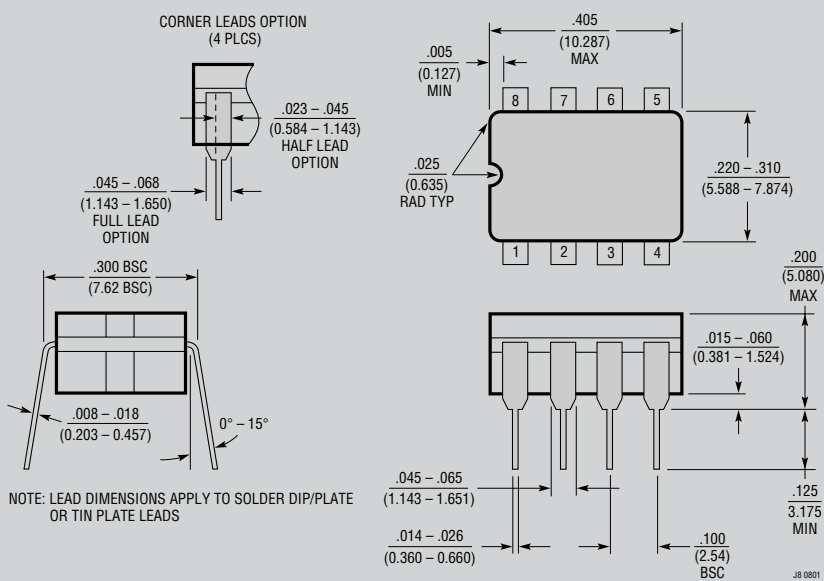

NOTE: LEAD DIMENSIONS APPLY TO SOLDER DIP/PLATE OR TIN PLATE LEADS

**OBSOLETE PACKAGES**

**PACKAGE DESCRIPTION**

**N8 Package**  
**8-Lead PDIP (Narrow .300 Inch)**  
 (Reference LTC DWG # 05-08-1510)



NOTE:  
 1. DIMENSIONS ARE  $\frac{\text{INCHES}}{\text{MILLIMETERS}}$   
 \*THESE DIMENSIONS DO NOT INCLUDE MOLD FLASH OR PROTRUSIONS.  
 MOLD FLASH OR PROTRUSIONS SHALL NOT EXCEED .010 INCH (0.254mm)

**SW Package**  
**16-Lead Plastic Small Outline (Wide .300 Inch)**  
 (Reference LTC DWG # 05-08-1620)

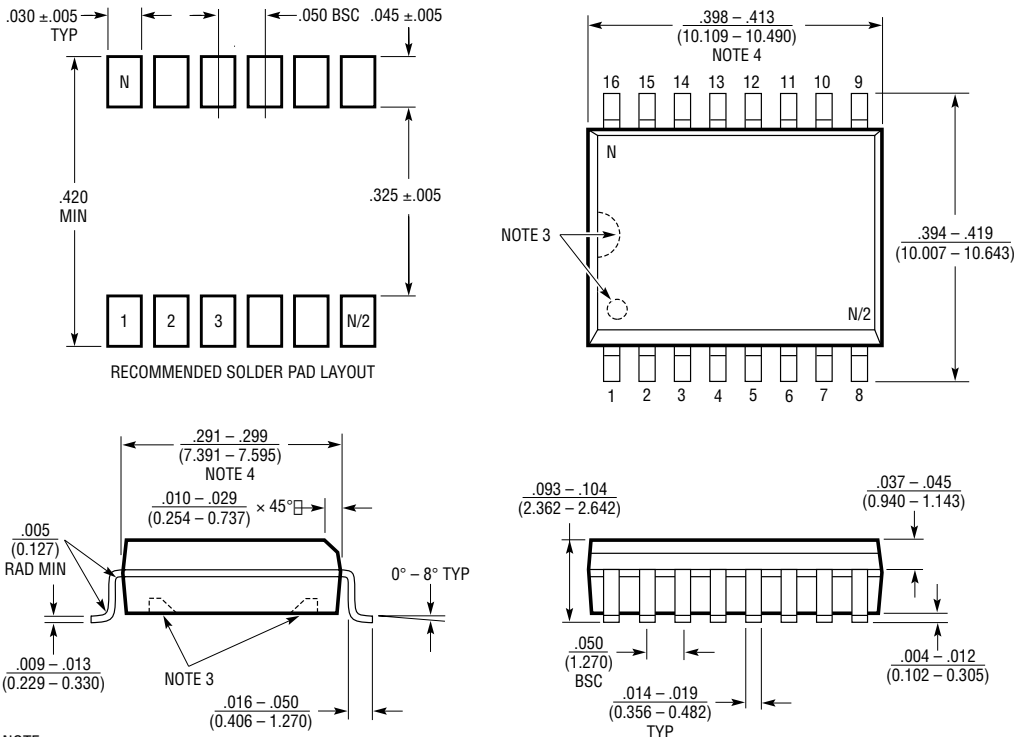

NOTE:  
 1. DIMENSIONS IN  $\frac{\text{INCHES}}{\text{MILLIMETERS}}$   
 2. DRAWING NOT TO SCALE  
 3. PIN 1 IDENT, NOTCH ON TOP AND CAVITIES ON THE BOTTOM OF PACKAGES ARE THE MANUFACTURING OPTIONS.  
 THE PART MAY BE SUPPLIED WITH OR WITHOUT ANY OF THE OPTIONS  
 4. THESE DIMENSIONS DO NOT INCLUDE MOLD FLASH OR PROTRUSIONS.  
 MOLD FLASH OR PROTRUSIONS SHALL NOT EXCEED .006" (0.15mm)

S16 (WIDE) 0502





## Стандарт Электрон Связь

Мы молодая и активно развивающаяся компания в области поставок электронных компонентов. Мы поставляем электронные компоненты отечественного и импортного производства напрямую от производителей и с крупнейших складов мира.

Благодаря сотрудничеству с мировыми поставщиками мы осуществляем комплексные и плановые поставки широчайшего спектра электронных компонентов.

Собственная эффективная логистика и склад в обеспечивает надежную поставку продукции в точно указанные сроки по всей России.

Мы осуществляем техническую поддержку нашим клиентам и предпродажную проверку качества продукции. На все поставляемые продукты мы предоставляем гарантию .

Осуществляем поставки продукции под контролем ВП МО РФ на предприятия военно-промышленного комплекса России , а также работаем в рамках 275 ФЗ с открытием отдельных счетов в уполномоченном банке. Система менеджмента качества компании соответствует требованиям ГОСТ ISO 9001.

Минимальные сроки поставки, гибкие цены, неограниченный ассортимент и индивидуальный подход к клиентам являются основой для выстраивания долгосрочного и эффективного сотрудничества с предприятиями радиоэлектронной промышленности, предприятиями ВПК и научно-исследовательскими институтами России.

С нами вы становитесь еще успешнее!

### Наши контакты:

**Телефон:** +7 812 627 14 35

**Электронная почта:** [sales@st-electron.ru](mailto:sales@st-electron.ru)

**Адрес:** 198099, Санкт-Петербург,  
Промышленная ул, дом № 19, литера Н,  
помещение 100-Н Офис 331