

Headphone Amplifiers

Coupling Capacitorless Headphone Amplifiers



BD88400GUL, BD88410GUL, BD88415GUL, BD88420GUL

No.11102EAT04

●Description

BD88xxxGUL is output coupling capacitorless headphone amplifier. This IC has a negative voltage generator of regulated type built-in and generates the direct regulated negative voltage from the supply voltage. It is possible to drive headphones in a ground standard with both voltage of the positive voltage (+2.4V) and the negative voltage (-2.4V). Therefore a large-capacity output coupling capacitor becomes needless and can reduce a cost, a board area, and the height of the part. In addition, there is not the signal decrement by the low range to happen by output coupling capacitor and output load impedance and can output a rich low tone.

●Features

- 1) 2.4V to 5.5V Single-Supply Operation
- 2) No Bulky DC-Blocking Capacitors Required
- 3) No Degradation of Low-Frequency Response Due to Output Capacitors
- 4) Ground-Referenced Outputs
- 5) Gain setting
 - BD88400GUL: Variable gain with external resistors
 - BD88410GUL: -1.0V/V
 - BD88415GUL: -1.5V/V
 - BD88420GUL: -2.0V/V
- 6) Low THD+N
- 7) Low Supply Current
- 8) Integrated Negative Power Supply
- 9) Integrated Short-Circuit and Thermal-Overload Protection
- 10) Small package
 - VCSP50L2 (2.1mm x 2.1mm)

●Applications

Mobile Phones, Smart Phones, PDAs, Portable Audio Players, PCs, TVs, Digital Cameras, Digital Video Cameras, Electronic Dictionaries, Voice Recorders, Bluetooth Head-sets, etc

●Line up

Type	Supply Voltage [V]	Supply Current [mA]	Gain [V/V]	Maximum Output Power [mW]	THD+N [%]	Noise Voltage [μ Vrms]	PSRR [dB]	Package
BD88400GUL	2.4~5.5	2.0 (No signal)	Variable gain with external resistor	80 (VDD=3.3V, RL=16 Ω THD+N \leq 1%, f=1kHz)	0.006 (VDD=3.3V, RL=16 Ω Po=10mW, f=1kHz)	10	-80 (f=217Hz)	VCSP50L2 (2.1mm x 2.1mm)
BD88410GUL			-1.0					
BD88415GUL			-1.5					
BD88420GUL			-2.0					

● Absolute maximum ratings

Parameter	Symbol	Ratings	Unit
SGND to PGND voltage	V_{GG}	0.0	V
SVDD to PVDD voltage	V_{DD}	-0.3~0.3	V
SVSS to PVSS voltage	V_{SS}	0.0	V
SGND or PGND to SVDD, PVDD voltage	V_{DG}	-0.3~6.0	V
SVSS, PVSS to SGND or PGND voltage	V_{SG}	-3.5~0.3	V
SGND to IN_- voltage	V_{IN}	(SVSS-0.3)~2.8	V
SGND to OUT_- voltage	V_{OUT}	(SVSS-0.3)~2.8	V
PGND to C1P- voltage	V_{C1P}	(PGND-0.3)~(PVDD+0.3)	V
PGND to C1N- voltage	V_{C1N}	(PVSS-0.3)~(PGND+0.3)	V
SGND to SHDN_B- voltage	V_{SH}	(SGND-0.3)~(SVDD+0.3)	V
Input current	I_{IN}	-10~10	mA
Power Dissipation	P_D	1350 *	mW
Storage Temperature Range	T_{STG}	-55~150	°C

* In operating over 25 °C, de-rate the value to 10.8mW/°C. This value is for mounted on the application board (Grass-epoxy, size: 40mm x 60mm, H=1.6mm, Top Copper area = 79.9%, Bottom Copper area = 80.2%).

● Operating conditions

Parameter	Symbol	Ratings			Unit
		Min.	Typ.	Max.	
Supply Voltage Range	V_{SVDD}, V_{PVDD}	2.4	-	5.5	V
Operating Temperature Range	T_{OPR}	-40	-	+85	°C

●Electrical characteristics

Unless otherwise specified, Ta=25°C, SVDD=PVDD=3.3V, SGND=PGND=0V, SHDNB=SVDD, C1=C2=2.2μF, RL=No Load, Ri=Rf=10kΩ

Parameter	Symbol	Limits			Unit	Conditions	
		Min.	Typ.	Max.			
Supply Current							
Shutdown Supply Current	I _{ST}	-	0.1	2	μA	SHDNLB=SHDNRB=L	
Quiescent Supply Current	I _{DD1}	-	1.3	-	mA	(SHDNLB,SHDNRB)=(H,L) or (L,H), No signal	
	I _{DD2}	-	2.0	7.4	mA	SHDNLB=SHDNRB=H, No signal	
SHDN_B Terminal							
H Level Input Voltage	V _{IH}	1.95	-	-	V		
L Level Input Voltage	V _{IL}	-	-	0.70	V		
Input Leak Current	I _{LEAK}	-	-	±1	μA		
Headphone Amplifier							
Shutdown to Full Operation	t _{SON}	-	80	-	μs	SHDNLB=SHDNRB=L→H	
Offset Voltage	V _{IS}	-	±0.5	±5.0	mV		
Maximum Output Power	P _{OUT}	30	60	-	mW	RL=32Ω, THD+N≤-40dB, f=1kHz, 20kHz LPF, for Single Channel	
		40	80	-	mW	RL=16Ω, THD+N≤-40dB, f=1kHz, 20kHz LPF, for Single Channel	
Total Harmonic Distortion + Noise	THD+N	-	0.008	0.056	%	RL=32Ω, POUT=10mW, f=1kHz, 20kHz LPF	
		-	0.006	0.100	%	RL=16Ω, POUT=10mW, f=1kHz, 20kHz LPF	
Input Impedance	Z _{IN}	10	14	19	kΩ	SHDNLB=SHDNRB=H In BD88400GUL, ZIN = Ri	
Gain	BD88400GUL	A _V	-	-1.00	-	V/V	In BD88400GUL, Gain is variable by the external resistor of Ri and Rf.
	BD88410GUL		-1.05	-1.00	-0.95		
	BD88415GUL		-1.55	-1.50	-1.45		
	BD88420GUL		-2.06	-2.00	-1.94		
Gain match	ΔA _V	-	1	-	%		
Noise	V _N	-	10	-	μVrms	20kHz LPF + JIS-A	
Slew Rate	SR	-	0.15	-	V/μs		
Maximum Capacitive Load	CL	-	200	-	pF		
Crosstalk	CT	-	-90	-	dB	RL=32Ω, f=1kHz, VOUT=200mV _{P-P} , 1kHz BPF	
Power Supply Rejection Ratio	PSRR	-	-80	-	dB	f=217Hz, 100mV _{P-P} - ripple, 217Hz BPF	
Charge-Pump Oscillator Frequency	f _{OSC}	200	300	430	kHz		
Thermal-Shutdown Threshold	T _{SD}	-	145	-	°C		
Thermal-Shutdown Hysteresis	T _{HYS}	-	5	-	°C		

● Electrical characteristic curves – General Items (Reference data)

Unless otherwise specified, Ta=25°C, SGND=PGND=0V, SHDNLB=SHDNRB=SVDD, C1=C2=2.2μF, Input coupling capacitor=1μF, RL=No Load * In BD88400GUL the input resistor(Ri)=10kΩ, feedback resistor(Rf)=10kΩ.

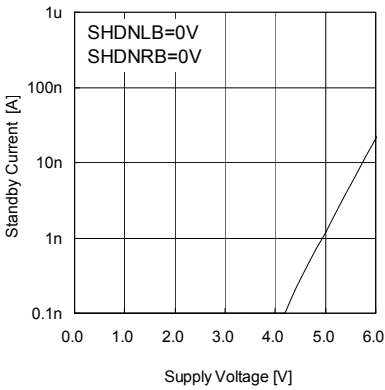

Fig.1 Standby Current vs. Supply Voltage

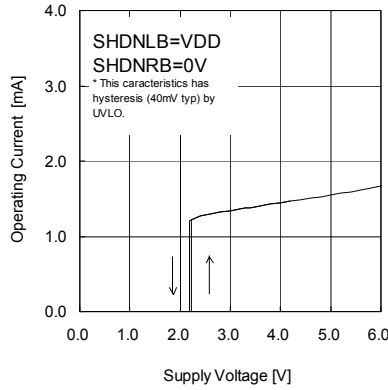

Fig.2 Monaural Operating Current vs. Supply Voltage

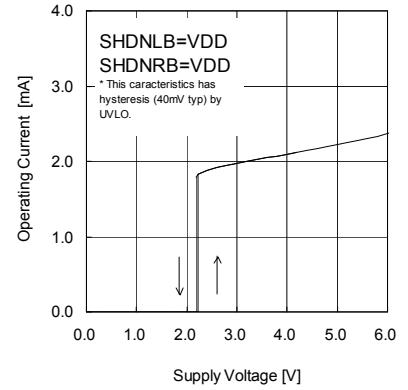

Fig.3 Stereo Operating Current vs. Supply Voltage

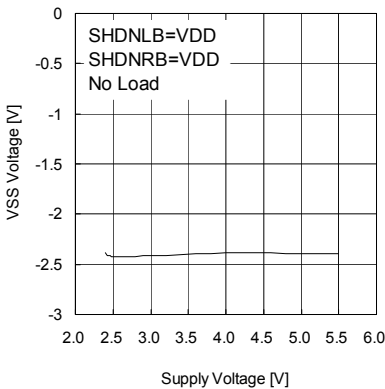

Fig.4 Negative Voltage vs. Supply Voltage

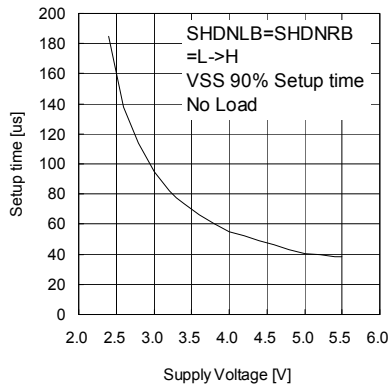

Fig.5 Setup time vs. Supply Voltage

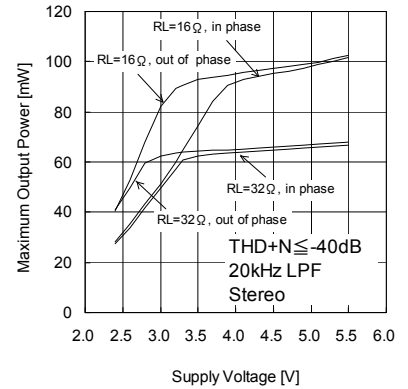

Fig.6 Maximum power vs. Supply Voltage

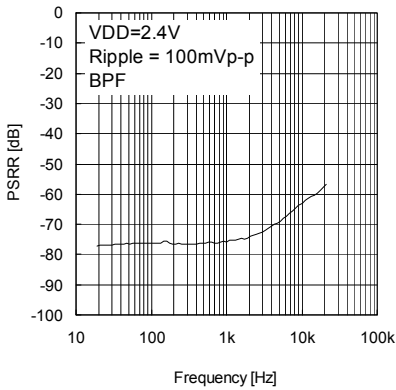

Fig.7 PSRR vs. Frequency (VDD=2.4V)

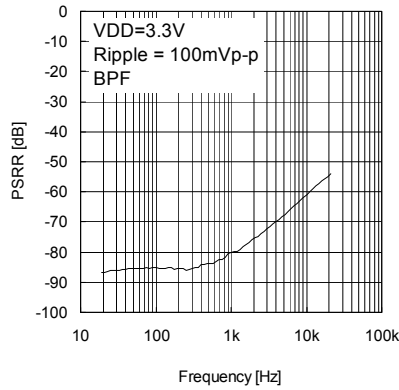

Fig.8 PSRR vs. Frequency (VDD=3.3V)

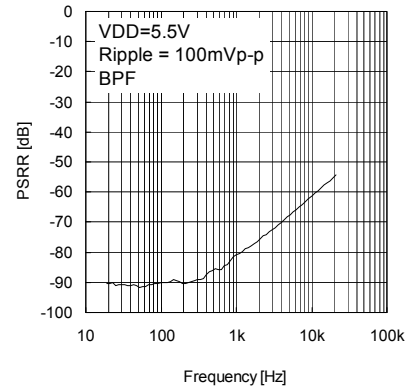

Fig.9 PSRR vs. Frequency (VDD=5.5V)

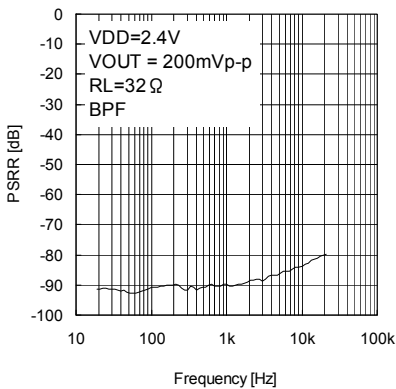

Fig.10 Crosstalk vs. Frequency (VDD=2.4V)

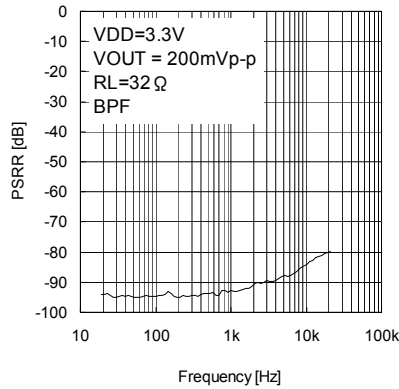

Fig.11 Crosstalk vs. Frequency (VDD=3.3V)

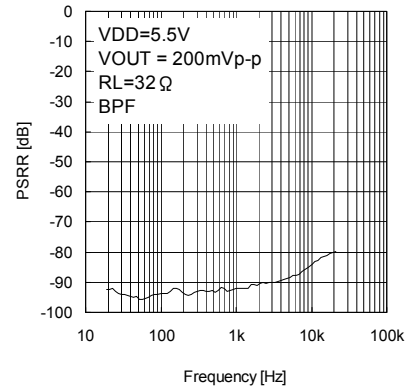

Fig.12 Crosstalk vs. Frequency (VDD=5.5V)

●Electrical characteristic curves – BD88415GUL (Reference data)



Fig. 13 Output Voltage vs. Input Voltage (VDD=2.4V)



Fig. 14 Output Voltage vs. Input Voltage (VDD=3.3V)



Fig. 15 Output Voltage vs. Input Voltage (VDD=5.5V)



Fig. 16 Gain vs. Frequency (VDD=2.4V)

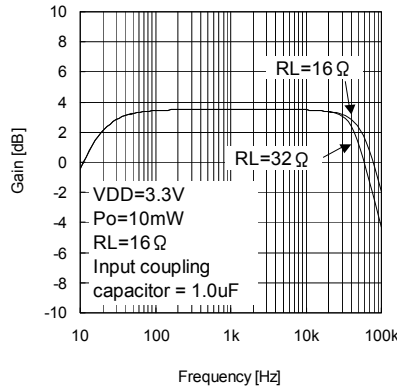

Fig. 17 Gain vs. Frequency (VDD=3.3V)



Fig. 18 Gain vs. Frequency (VDD=5.5V)

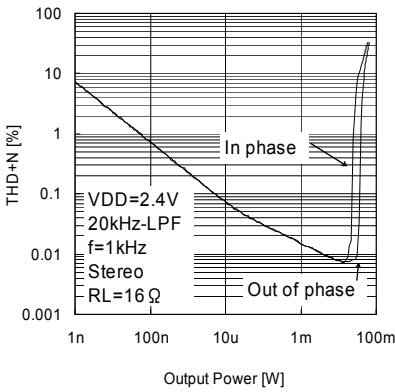

Fig. 19 THD+N vs. Output Power (VDD=2.4V, RL=16Ω)

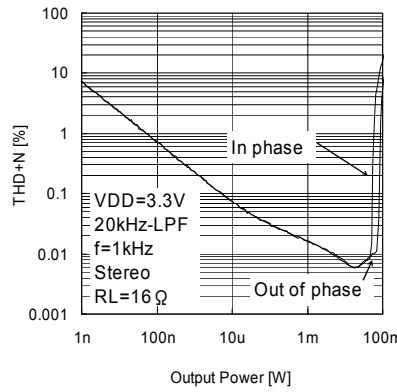

Fig. 20 THD+N vs. Output Power (VDD=3.3V, RL=16Ω)

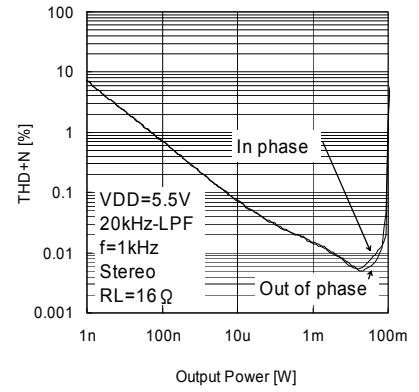

Fig. 21 THD+N vs. Output Power (VDD=5.5V, RL=16Ω)

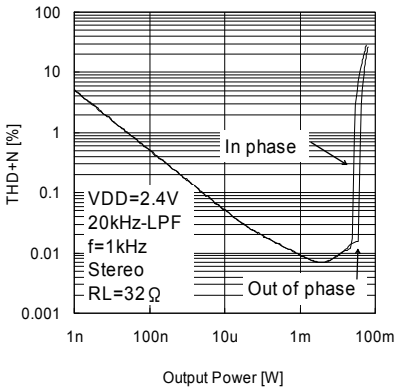

Fig. 22 THD+N vs. Output Power (VDD=2.4V, RL=32Ω)

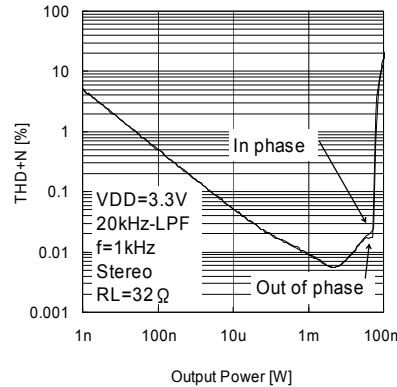

Fig. 23 THD+N vs. Output Power (VDD=3.3V, RL=32Ω)

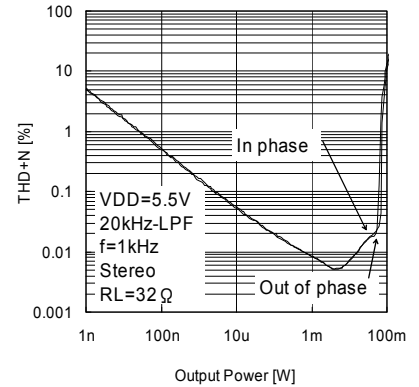

Fig. 24 THD+N vs. Output Power (VDD=5.5V, RL=32Ω)

●Electrical characteristic curves – BD88415GUL (Reference data) – Continued

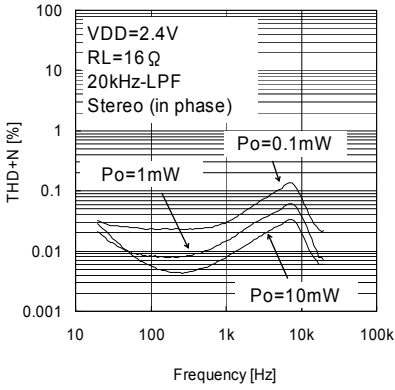

Fig.25 THD+N vs. Frequency (VDD=2.4V, RL=16Ω)

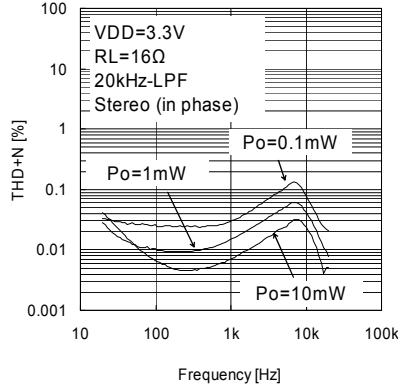

Fig. 26 THD+N vs. Frequency (VDD=3.3V, RL=16Ω)

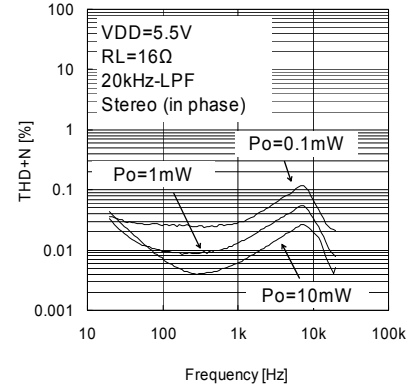

Fig. 27 THD+N vs. Frequency (VDD=5.5V, RL=16Ω)



Fig. 28 THD+N vs. Frequency (VDD=2.4V, RL=32Ω)



Fig. 29 THD+N vs. Frequency (VDD=3.3V, RL=32Ω)



Fig. 30 THD+N vs. Frequency (VDD=5.5V, RL=32Ω)

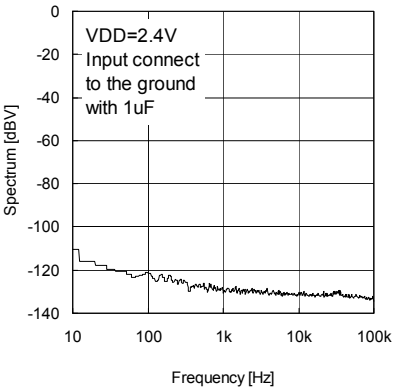

Fig.31 Noise Spectrum (VDD=2.4V)

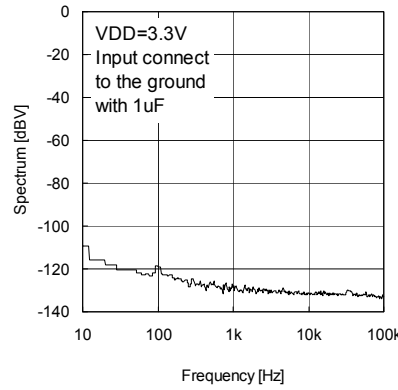

Fig.32 Noise Spectrum (VDD=3.3V)

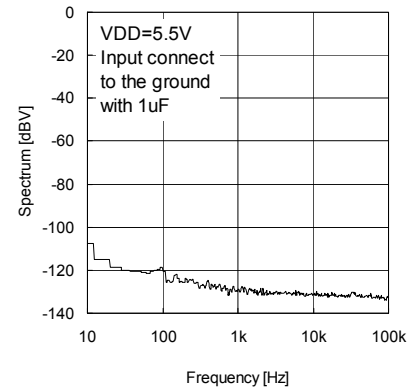

Fig.33 Noise Spectrum (VDD=5.5V)

●Electrical characteristic curves – BD88400GUL (Reference data)

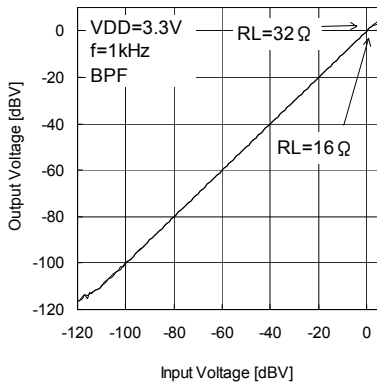

Fig.34 Output Voltage vs. Input Voltage (VDD=3.3V)



Fig.35 Gain vs. Frequency (VDD=3.3V)

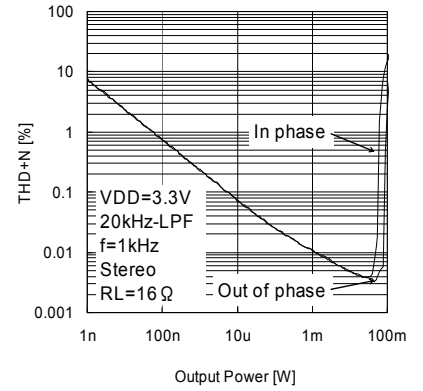

Fig.36 THD+N vs. Output Power (VDD=3.3V, RL=16Ω)

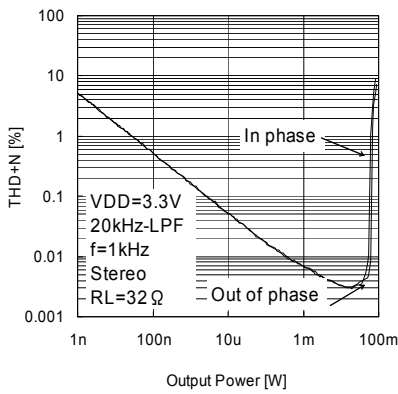

Fig. 37 THD+N vs. Output Power (VDD=3.3V, RL=32Ω)

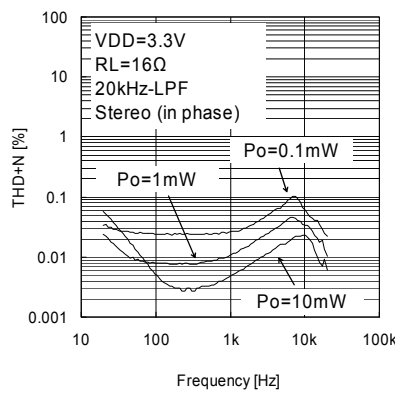

Fig.38 THD+N vs. Frequency (VDD=3.3V, RL=16Ω)

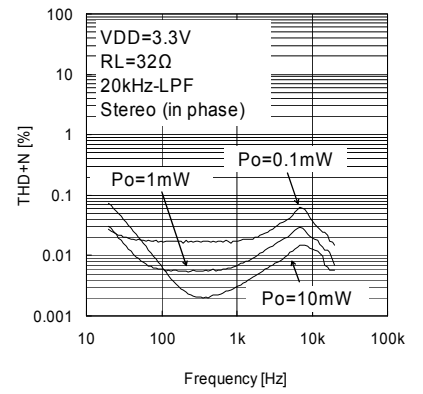

Fig. 39 THD+N vs. Frequency (VDD=3.3V, RL=32Ω)

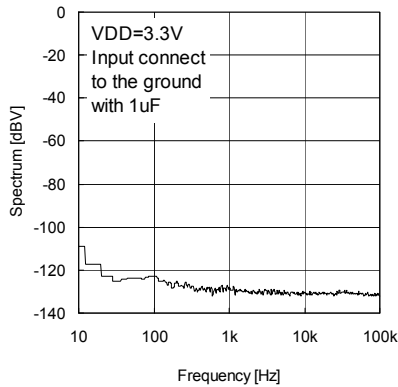

Fig.40 Noise Spectrum (VDD=3.3V)

●Electrical characteristic curves – BD88410GUL (Reference data)



Fig.41 Output Voltage vs. Input Voltage (VDD=3.3V)

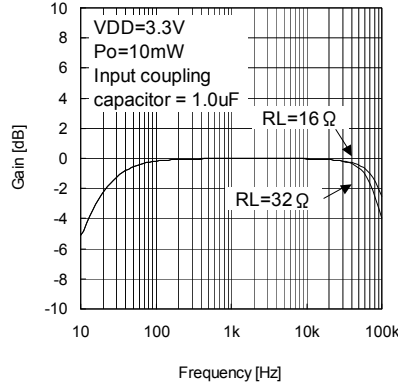

Fig.42 Gain vs. Frequency (VDD=3.3V)

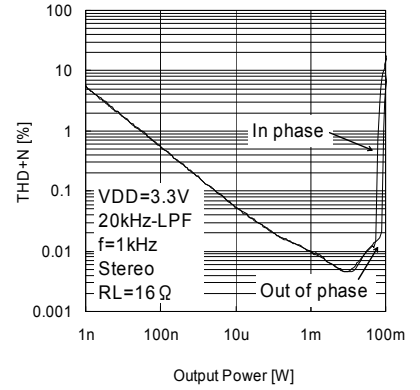

Fig.43 THD+N vs. Output Power (VDD=3.3V, RL=16Ω)



Fig.44 THD+N vs. Output Power (VDD=3.3V, RL=32Ω)

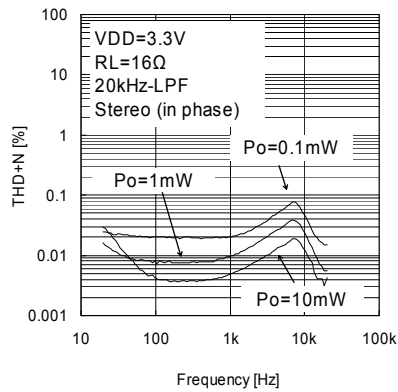

Fig.45 THD+N vs. Frequency (VDD=3.3V, RL=16Ω)

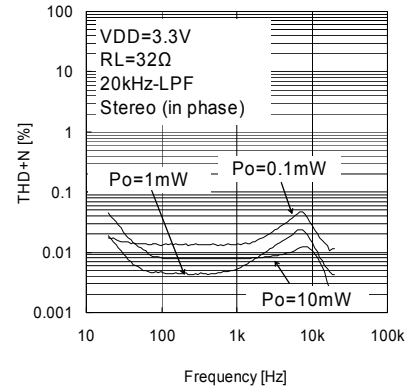

Fig.46 THD+N vs. Frequency (VDD=3.3V, RL=32Ω)

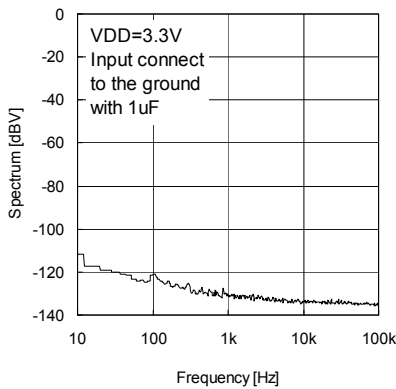

Fig.47 Noise Spectrum (VDD=3.3V)

●Electrical characteristic curves – BD88420GUL (Reference data)

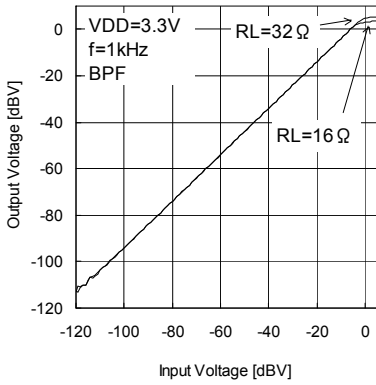

Fig.48 Output Voltage vs. Input Voltage (VDD=3.3V)

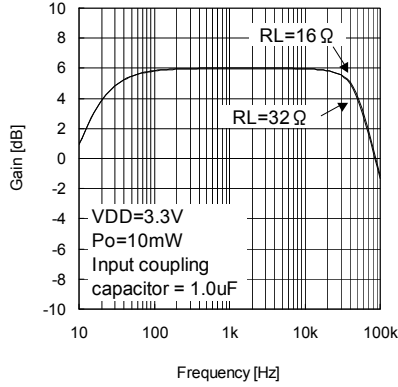

Fig.49 Gain vs. Frequency (VDD=3.3V)

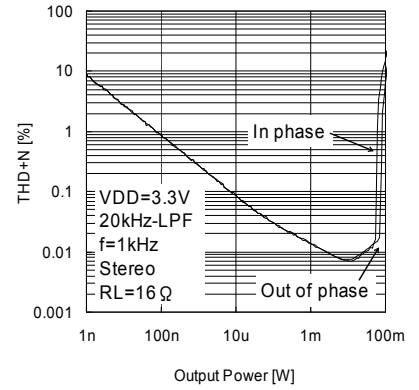

Fig.50 THD+N vs. Output Power (VDD=3.3V, RL=16Ω)

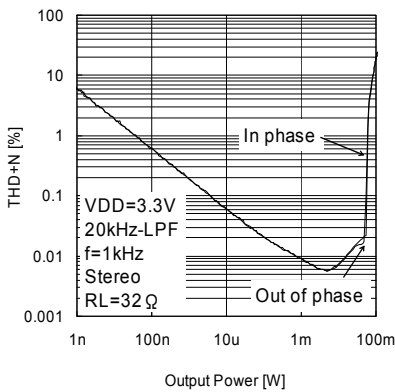

Fig.51 THD+N vs. Output Power (VDD=3.3V, RL=32Ω)

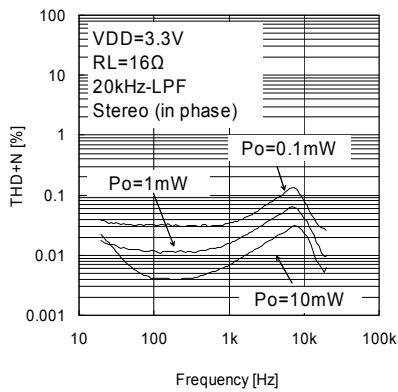

Fig.52 THD+N vs. Frequency (VDD=3.3V, RL=16Ω)

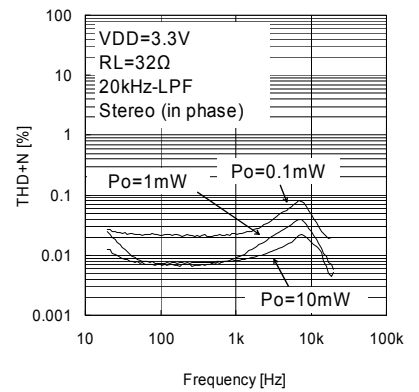

Fig.53 THD+N vs. Frequency (VDD=3.3V, RL=32Ω)



Fig.54 Noise Spectrum (VDD=3.3V)

● Pin Arrangement

	1	2	3	4
D	SVDD	OUTL	SVSS	PVSS
C	INL	OUTR		C1N
B	SHDNRB	SHDNLB		PGND
A	INR	SGND	PVDD	C1P

(Bottom View)

● Pin Function

Ball Matrix	Pin name	Function	Symbol
A1	INR	Headphone Amplifier (Rch) input	C
A2	SGND	Ground for Headphone Amplifier	-
A3	PVDD	Positive Power Supply for Charge Pump	-
A4	C1P	Flying Capacitor (CF) Positive	A
B1	SHDNRB	Headphone Amplifier (Rch) Shutdown Control (H:active, L:shutdown)	E
B2	SHDNLB	Headphone Amplifier (Lch) Shutdown Control (H:active, L:shutdown)	E
B4	PGND	Ground for Charge Pump	-
C1	INL	Headphone Amplifier (Lch) input	C
C2	OUTR	Headphone Amplifier (Rch) output	D
C4	C1N	Flying Capacitor (CF) Negative	B
D1	SVDD	Ground for Headphone Amplifier	-
D2	OUTL	Headphone Amplifier (Lch) output	D
D3	SVSS	Negative Supply Voltage for Signal	-
D4	PVSS	Negative Supply Voltage output	F

● Pin equivalent circuit

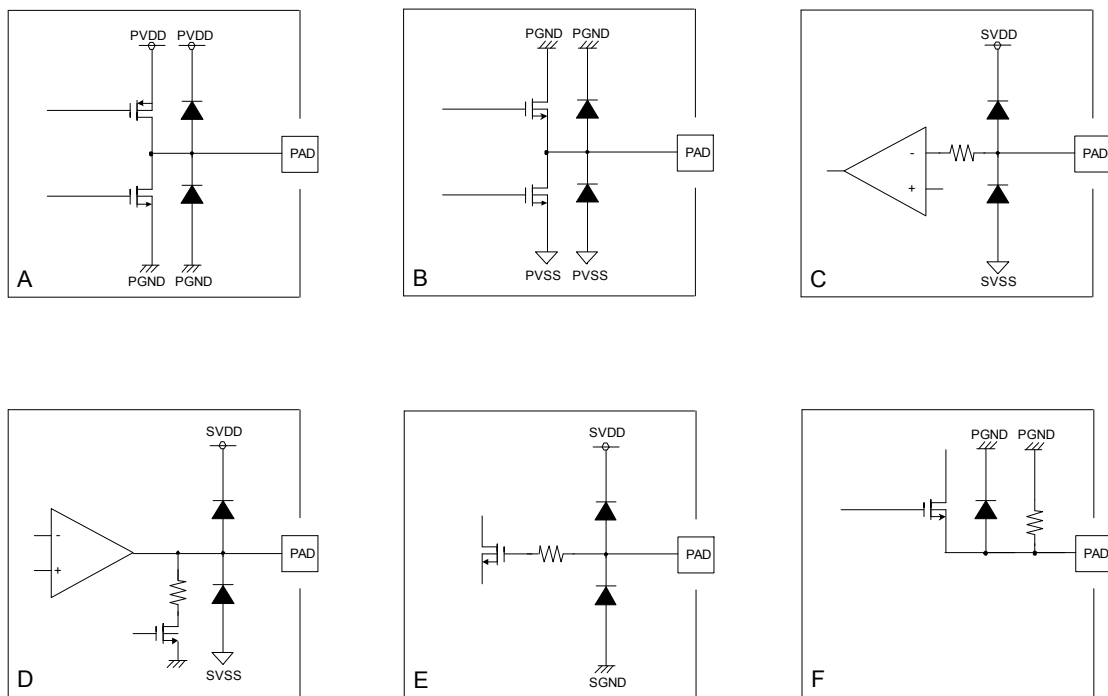

Fig.55 Pin equivalent circuit

●Block Diagram



Type	Rin	Rfb
BD88400GUL	14kΩ @Typ.	Open
BD88410GUL	14kΩ @Typ.	14kΩ @Typ.
BD88415GUL	14kΩ @Typ.	21kΩ @Typ.
BD88420GUL	14kΩ @Typ.	28kΩ @Typ.

Fig.56 Block Diagram

●Functional descriptions

The conventional headphone amplifier composition is occupied to Fig.57. In this composition, the signal is output by using the middle point bias circuit based on the middle point bias. Therefore, the output coupling capacitor that removes the DC voltage difference and does the AC coupling is necessary. This coupling capacitor and the impedance of the headphone composes the high-pass filter. Therefore, the signal degradation in the low frequency region learns by experience. The output coupling capacitor should be a large capacity, because the cutoff frequency of this high-pass filter becomes the following formula (1).

$$f_c = \frac{1}{2\pi R_L C_C} \quad (1)$$

* Cc is the coupling capacitor, and RL is the impedance of the headphone.

Moreover, POP noise by the middle point bias start-up is generated and the degradation of PSRR learns by experience.



Fig.57 Conventional headphone amplifier composition

The composition of the series of BD884xxGUL is occupied to Fig.58. In this composition, the signal is output by using a negative voltage based on the ground level. Therefore, the amplifier output can be connected directly with the headphone. And, the output coupling capacitor becomes unnecessary. Additionally, the signal degradation in the low frequency region with the coupling capacitor is not generated, and the deep bass is achieved. Moreover, POP noise is controlled because of no middle point bias start-up. And, the degradation of PSRR doesn't occur by being based on the ground.

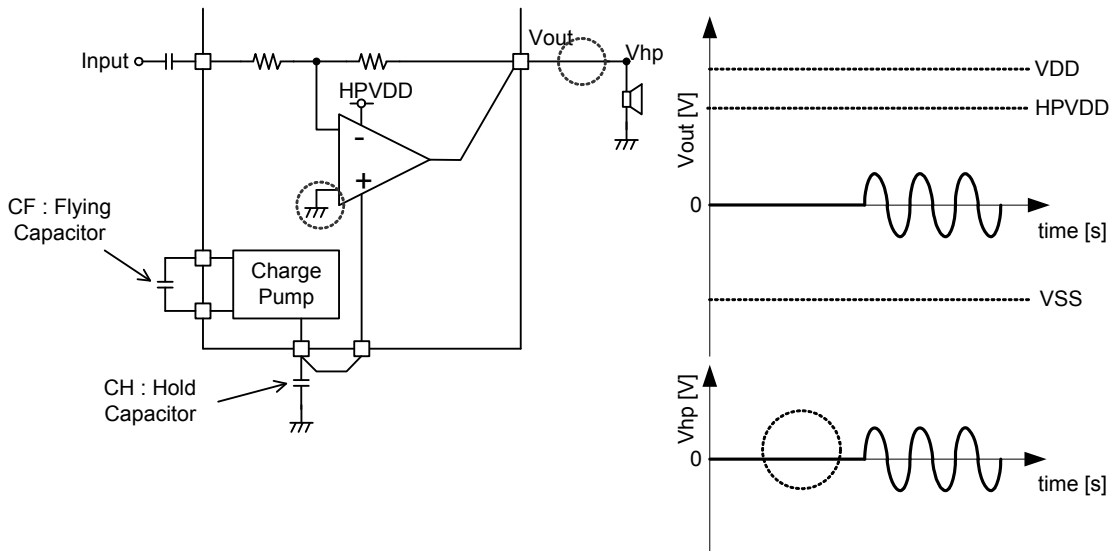

Fig.58 Composition of the series of BD884xxGUL

[CHARGE PUMP / CHARGE PUMP CONTROL]

The negative power supply circuit is composed of the regulated charge-pump. This circuit outputs the regulated negative voltage (PVSS) directly from power-supply voltage (PVDD). Therefore, it doesn't depend on the power-supply voltage, and a constant voltage is output (PVSS=-2.4V@Typ., refer to Fig.4). Moreover, there is not swinging of the power supply by the output current of the headphone amplifier, and it doesn't influence the headphone amplifier characteristic.

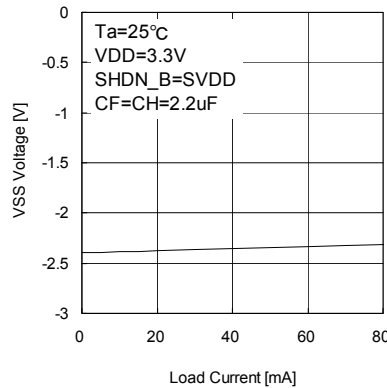

Fig.59 Characteristics of load current regulation of PVSS (Reference data)

• Power control

The power control is a logical sum of SHDNLB and SHDNRB. The negative power supply circuit starts when H level is input to either of SHDNLB or SHDNRB, and power is downed at the SHDNLB=SHDNRB=L level.

Table.1 Control of the charge pump

SHDNLB	SHDNRB	Control
L	L	Power down
L	H	Power on
H	L	Power on
H	H	Power on

• Operating Frequency

The operating frequency of the negative power supply charge pump is designed for the temperature and the voltage dependence may decrease. The reference data (measurements) is occupied to Fig.60. Please note the interference with the frequency in the application board.

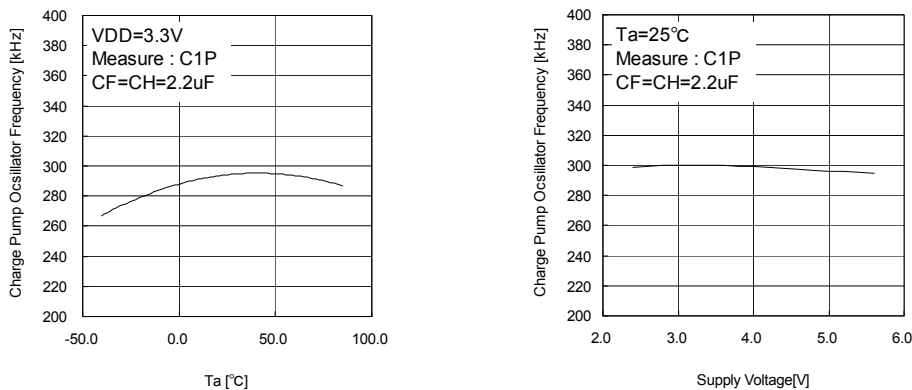

Fig.60 Temperature characteristic and Voltage characteristic of operating frequency (Reference data)

• The flying capacitor and the hold capacitor

The flying capacitor (CF) and the hold capacitor (CH) greatly influence the characteristic of the charge pump. Therefore, please connect the capacitor with an excellent temperature characteristic and voltage characteristic of 2.2μF as much as possible near IC.

[HEADPHONE AMP]

The headphone amplifier is driven by the internal positive voltage (+2.4V) and negative voltage (SVSS, -2.4V) based on ground (SGND). Therefore, the headphone can be connected without the output coupling capacitor. As a result, it brings the improved low-frequency characteristic compared with the headphone of the conventional coupling capacitor type.

• Power control

L channel and R channel of the headphone amplifier can be independently controlled by SHDNLB and SHDNRB logic. When the SVSS voltage is -1.1V@Typ. or more, the headphone amplifier does not operate to protect from illegal operation. And in addition, the overcurrent protection circuit is built in. The amplifier is shutdown when the overcurrent occurs because of the output short-circuit etc., and IC is protected from being destroyed.

Table.2 Control of the headphone amplifier

SHDNLB	SHDNRB	L channel	R channel
L	L	Power down	Power down
L	H	Power down	Power on
H	L	Power on	Power down
H	H	Power on	Power on



Fig.61 Area of headphone amplifier can operate

SVSS does not have internal connection with PVSS. Please connect SVSS with PVSS on the application board.

• Input coupling capacitor

Input DC level of BD884xxGUL is 0V (SGND). The input coupling capacitor is necessary for the connection with the signal source device. The signal decrease happens in the low frequency because of composing the high-pass filter by this input coupling capacitor and the input impedance of BD884xxGUL.

The input impedance of BD884xxGUL is Rin (14kΩ@Typ.). The cutoff frequency of this high-pass filter becomes the following formula. (In BD88400GUL, Rin becomes external resistance Ri.)

$$f_c = \frac{1}{2\pi R_{in} C_{in}} \quad (2)$$

* Cin is the input coupling capacitor.

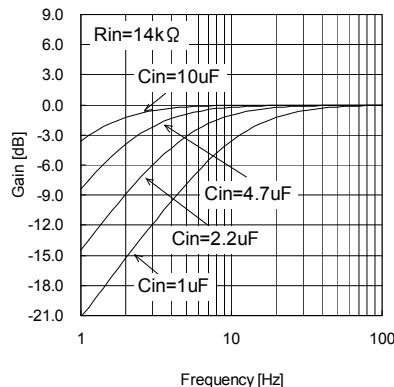

Fig.62 Frequency response by the input coupling capacitor (Reference data)

And, the degradation of THD+N happens because of the input coupling capacitor. Therefore, please consider these about the selection of parts.



* Capacitor size: 1608

Fig.63 THD+N by the input coupling capacitor (Reference data)

• State of terminal when power down

The state of the terminal changes by the power control of the headphone amplifier. When it is shutdown, the input impedance of the input terminal becomes $7.1k\Omega_{Typ}$. (In BD88400GUL, become $R_i + 7.1k\Omega$). The time constant can be reduced when the input coupling capacitor is charged.

The input voltage changes while charging up the input coupling capacitor. Therefore, do not operate the headphone amplifier while charging.



Fig.64 Input voltage transition with input coupling capacitor

This charge time constant becomes the following formula (3) by using the input coupling capacitor and the input impedance. And the calculation value of the convergence to the wait time is indicated in Fig.65.

$$\tau = R_{in}C_{in} \quad (3)$$

* $R_{in}=7.1k\Omega_{Typ}$. In BD88400GUL, $R_{in}=R_i+7.1k\Omega$



Fig.65 Wait time and convergence (Reference)

[UVLO / SHUTDOWN CONTROL]

BD884xxGUL has low voltage protection function (UVLO: Under Voltage Lock Out). And protect from the illegal operation of IC by a low power supply voltage.

The detection voltage is $2.13V_{@Typ.}$, so it does not influence 2.4V of recommended operation voltage. UVLO controls the whole of IC, and does both the negative power supply charge pump and the headphone amplifier in power down.

[TSD]

BD884xxGUL has overheating protection function (TSD: Thermal Shutdown). And the headphone amplifier becomes shutdown when illegally overheating by the headphone amplifier illegally operation.

● Timing Chart

(Usually Operation)



Fig.66 Usually Operation

(UVLO Operation)

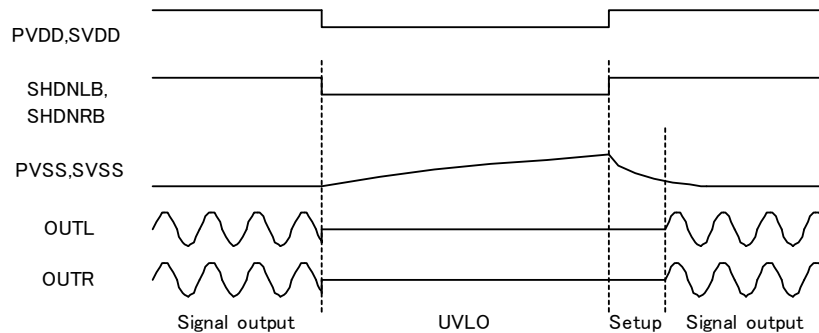

Fig.67 UVLO Operation

(TSD Operation)

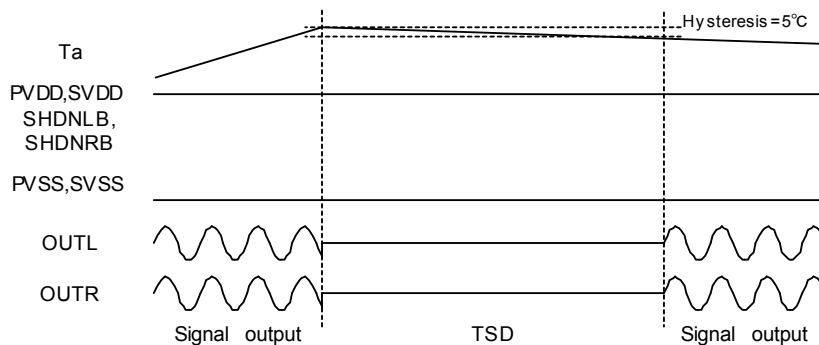

Fig.68 TSD Operation

●Application Circuit



Fig.69 BD88410GU/BD88415GUL/BD88420GUL application circuit

Part	Function	value	Remarks
CF	Flying Capacitor	2.2μF	Temp. Characteristic : Class-B
CH	Hold Capacitor	2.2μF	Temp. Characteristic : Class-B
Cpvdd	Bypass Capacitor	1.0μF	Temp. Characteristic : Class-B
Csvdd	Bypass Capacitor	1.0μF	Temp. Characteristic : Class-B
Cil	Coupling Capacitor	1.0μF	Temp. Characteristic : Class-B
Cir	Coupling Capacitor	1.0μF	Temp. Characteristic : Class-B



Fig.70 BD88400GUL application circuit

Part	Function	value	Remarks
CF	Flying Capacitor	2.2μF	Temp. Characteristic : Class-B
CH	Hold Capacitor	2.2μF	Temp. Characteristic : Class-B
Cpvdd	Bypass Capacitor	1.0μF	Temp. Characteristic : Class-B
Csvdd	Bypass Capacitor	1.0μF	Temp. Characteristic : Class-B
Cil	Coupling Capacitor	1.0μF	Temp. Characteristic : Class-B
Cir	Coupling Capacitor	1.0μF	Temp. Characteristic : Class-B
Ri	Input Resistor	10kΩ	MCR006YZPJ103 (ROHM)
Rf	Feedback Resistor	10kΩ	MCR006YZPJ103 (ROHM)

In BD88400GUL, the Pass Gain becomes the following formula (4). The Pass Gain and the resistor Rf is limited by table.3.

$$\text{Gain} = \frac{R_f}{R_i} \quad (4)$$

Table.3 Pass Gain and Resister Limit

Item	Min.	Typ.	Max.	Unit
Pass Gain	0.5	1.0	2.0	V/V
Rf	1.0	10	-	kΩ
Ri	-	10	-	kΩ

Ri is not limited. But, if this resistor Ri is very small, the signal decrease happens in the low frequency (Refer to formula 2).

● Thermal Derating Curve

The reference value of the thermal derating curve is indicated in Fig.71.

(Conditions)

This value is for mounted on the ROHM application board

Board size : 40mm x 60mm x 1.6mm

Top Copper Area : 79.9%

Bottom Copper Area : 80.2%

Board Layout : Fig.74

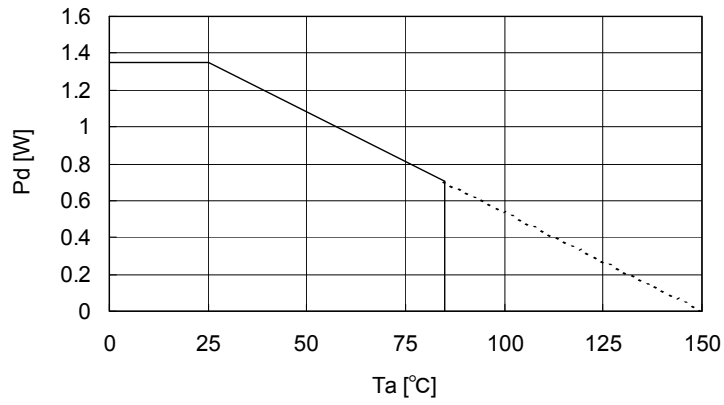

Fig.71 Thermal Derating Curve

●Evaluation Board

D8876FV Evaluation Board loads with the necessary parts. It can operate only by it. It is using RCA Connector for input terminal and Headphone jack ($\phi=3.5\text{mm}$) for output terminal. Therefore it can easily connect between Audio equipments. And it can operate by single supply (2.4 to 5.5V). The switch on the board (SDB) can control shutdown.

(Spec.)

Item	Limit	Unit
Supply Voltage Range (VDD)	3.0 to 5.5	V
Maximum Supply Current	1.0	A
Operating Temperature Range	-40 to 85	°C
Input Voltage Range	-2.5 to 2.5	V
Output Voltage Range	-2.5 to 2.5	V
Minimum Load Impedance	15	Ω

(Schematic)

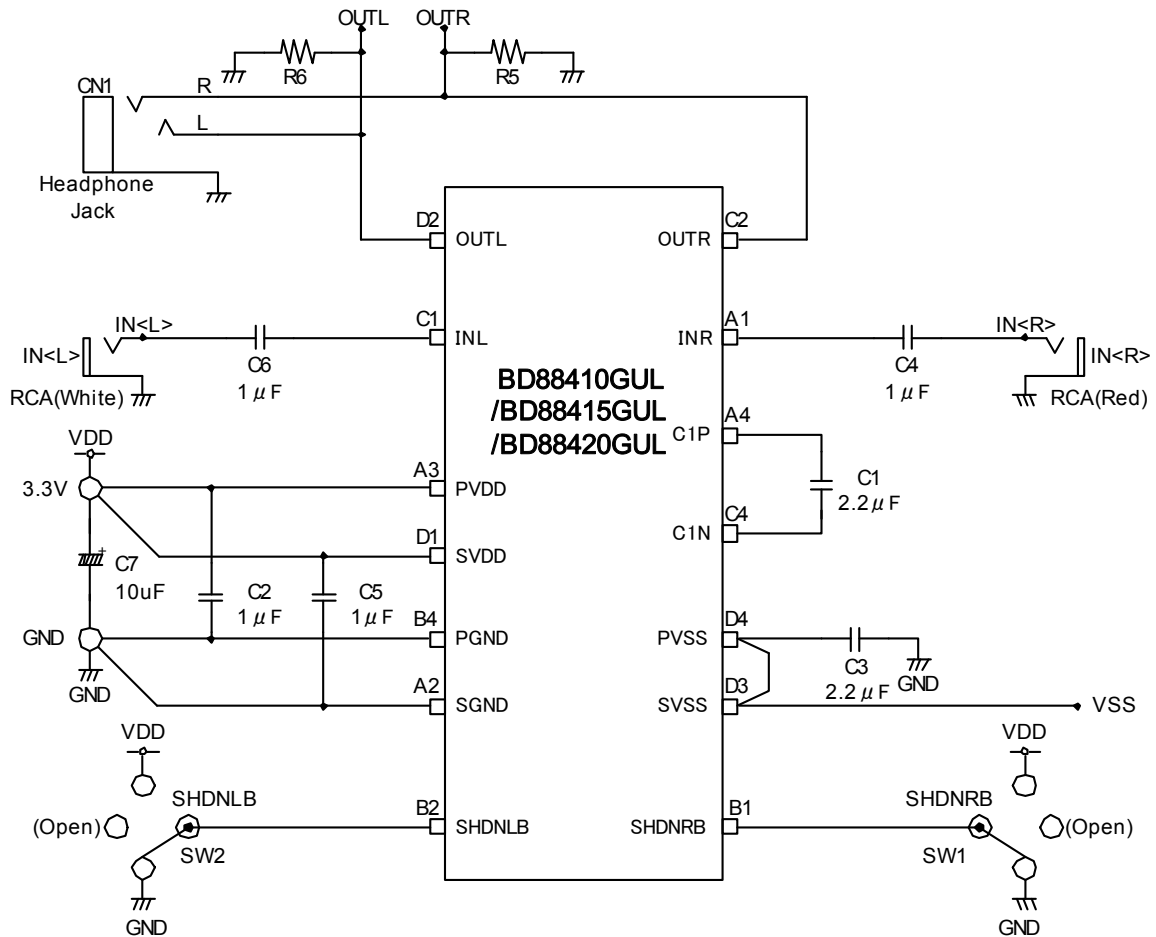

Fig.72 Evaluation Board Schematic (BD88410GUL/BD88415GUL/BD88420GUL)



Fig.73 Evaluation Board Schematic (BD88400GUL)

(Parts List)

Parts name	Type	Value	Size
U1	CSP-14pin	BD884xxGUL	2.1mm x 2.1mm
C1, C3	Chip Ceramic capacitor	2.2 μ F	1608
C2, C4~C6	Chip Ceramic capacitor	1.0 μ F	1608
C7	Tantalum capacitor	10 μ F	3216
R1~R4	Chip Resistor	10k Ω	1608
R5, R6	Chip Resistor	Open	-
CN1	Headphone jack	-	ϕ = 3.5mm
R1~R4 *	Chip Resistor	10k Ω	1608

*About BD88200GUL, R1~R4 of is the resistor for the gain setting.

(Operation procedure)

- ① Turn off the switch (SHDNLB/SHDNRB) on evaluation board.
- ② Connect the positive terminal of the power supply to the VDD pin and ground terminal to the GND pin.
- ③ Connect the left output of the audio source to the INL and connect the right output to the INR.
- ④ Turn on the power supply.
- ⑤ Turn on the switch (SHDNLB/SHDNRB) on the evaluation board. (H)
- ⑥ Input the audio source.

(Board Layout)

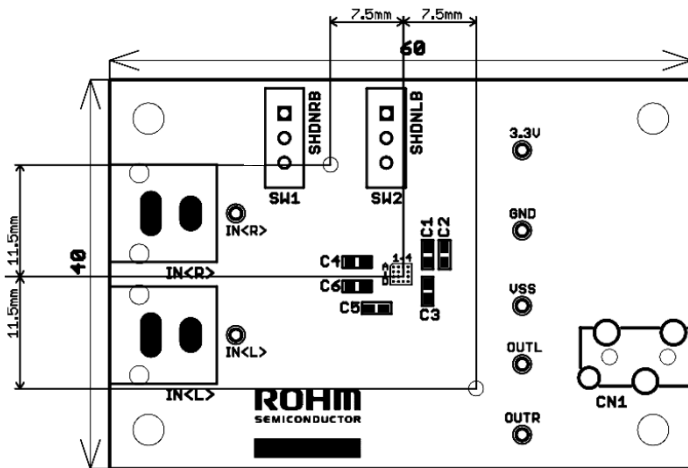

(TOP SILKSCREEN – TOP VIEW)

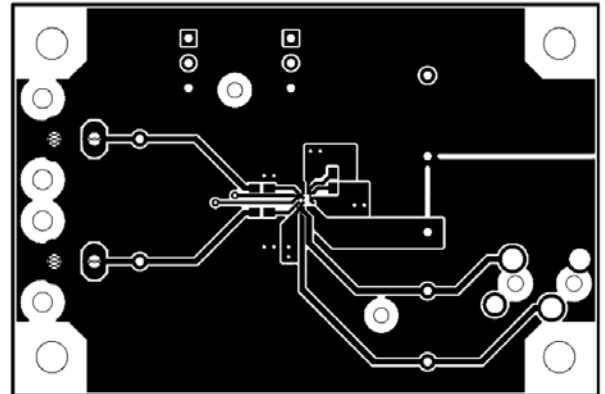

(TOP LAYER - TOP VIEW)

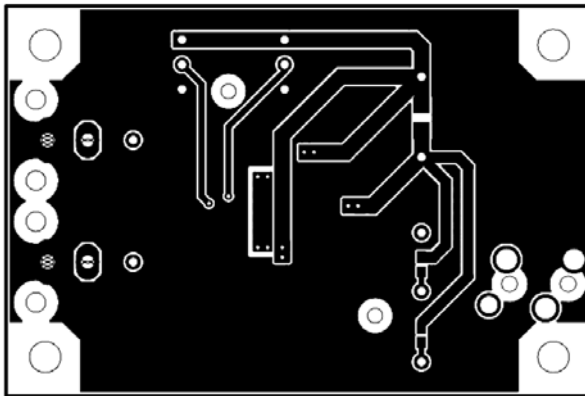

(BOTTOM LAYER – TOP VIEW)

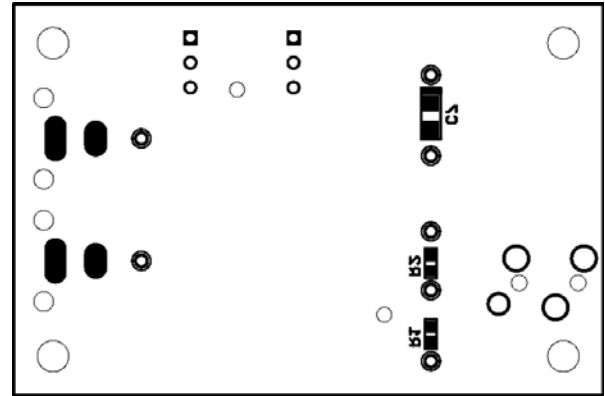

(BOTTOM SILKSCREEN – TOP VIEW)

Fig.74 ROHM Application Board Layout (BD88410GUL/BD88415GUL/BD88420GUL)



(TOP SILKSCREEN – TOP VIEW)



(TOP LAYER - TOP VIEW)



(BOTTOM LAYER – TOP VIEW)

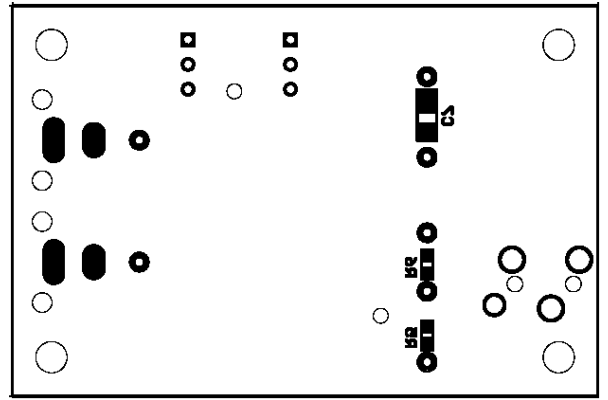

(BOTTOM SILKSCREEN – TOP VIEW)

Fig.75 ROHM Application Board Layout (BD88400GUL)

● Notes for use

- (1) Absolute Maximum Ratings
An excess in the absolute maximum ratings, such as supply voltage, temperature range of operating conditions, etc., can break down devices, thus making impossible to identify breaking mode such as a short circuit or an open circuit. If any special mode exceeding the absolute maximum ratings is assumed, consideration should be given to take physical safety measures including the use of fuses, etc.
- (2) Operating conditions
These conditions represent a range within which characteristics can be provided approximately as expected. The electrical characteristics are guaranteed under the conditions of each parameter.
- (3) Reverse connection of power supply connector
The reverse connection of power supply connector can break down ICs. Take protective measures against the breakdown due to the reverse connection, such as mounting an external diode between the power supply and the IC's power supply terminal.
- (4) Power supply line
Design PCB pattern to provide low impedance for the wiring between the power supply and the GND lines. In this regard, for the digital block power supply and the analog block power supply, even though these power supplies has the same level of potential, separate the power supply pattern for the digital block from that for the analog block, thus suppressing the diffraction of digital noises to the analog block power supply resulting from impedance common to the wiring patterns. For the GND line, give consideration to design the patterns in a similar manner.
Furthermore, for all power supply terminals to ICs, mount a capacitor between the power supply and the GND terminal. At the same time, in order to use an electrolytic capacitor, thoroughly check to be sure the characteristics of the capacitor to be used present no problem including the occurrence of capacity dropout at a low temperature, thus determining the constant.
- (5) GND voltage
Make setting of the potential of the GND terminal so that it will be maintained at the minimum in any operating state. Furthermore, check to be sure no terminals are at a potential lower than the GND voltage including an actual electric transient.
- (6) Short circuit between terminals and erroneous mounting
In order to mount ICs on a set PCB, pay thorough attention to the direction and offset of the ICs. Erroneous mounting can break down the ICs. Furthermore, if a short circuit occurs due to foreign matters entering between terminals or between the terminal and the power supply or the GND terminal, the ICs can break down.
- (7) Operation in strong electromagnetic field
Be noted that using ICs in the strong electromagnetic field can malfunction them.
- (8) Inspection with set PCB
On the inspection with the set PCB, if a capacitor is connected to a low-impedance IC terminal, the IC can suffer stress. Therefore, be sure to discharge from the set PCB by each process. Furthermore, in order to mount or dismount the set PCB to/from the jig for the inspection process, be sure to turn OFF the power supply and then mount the set PCB to the jig. After the completion of the inspection, be sure to turn OFF the power supply and then dismount it from the jig. In addition, for protection against static electricity, establish a ground for the assembly process and pay thorough attention to the transportation and the storage of the set PCB.
- (9) Input terminals
In terms of the construction of IC, parasitic elements are inevitably formed in relation to potential. The operation of the parasitic element can cause interference with circuit operation, thus resulting in a malfunction and then breakdown of the input terminal. Therefore, pay thorough attention not to handle the input terminals, such as to apply to the input terminals a voltage lower than the GND respectively, so that any parasitic element will operate. Furthermore, do not apply a voltage to the input terminals when no power supply voltage is applied to the IC. In addition, even if the power supply voltage is applied, apply to the input terminals a voltage lower than the power supply voltage or within the guaranteed value of electrical characteristics.
- (10) Ground wiring pattern
If small-signal GND and large-current GND are provided, It will be recommended to separate the large-current GND pattern from the small-signal GND pattern and establish a single ground at the reference point of the set PCB so that resistance to the wiring pattern and voltage fluctuations due to a large current will cause no fluctuations in voltages of the small-signal GND. Pay attention not to cause fluctuations in the GND wiring pattern of external parts as well.
- (11) External capacitor
In order to use a ceramic capacitor as the external capacitor, determine the constant with consideration given to a degradation in the nominal capacitance due to DC bias and changes in the capacitance due to temperature, etc.
- (12) About the rush current
For ICs with more than one power supply, it is possible that rush current may flow instantaneously due to the internal powering sequence and delays. Therefore, give special consideration to power coupling capacitance, power wiring, width of GND wiring, and routing of wiring.

● Ordering part number

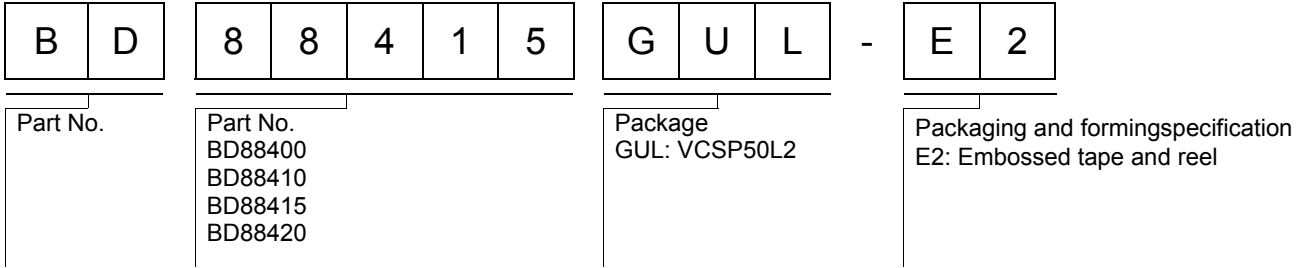

VCSP50L2(BD88400GUL)

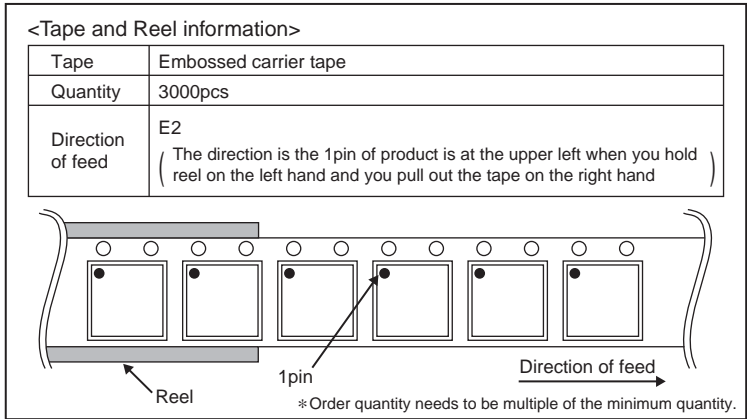
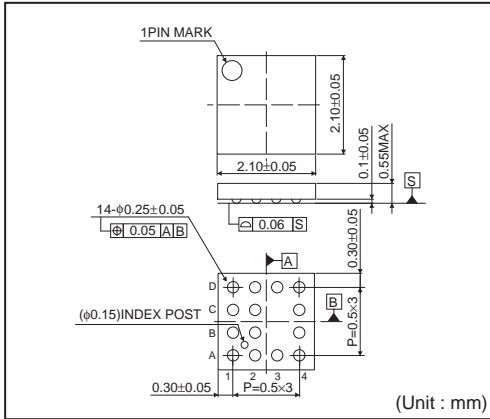

VCSP50L2(BD88410GUL)

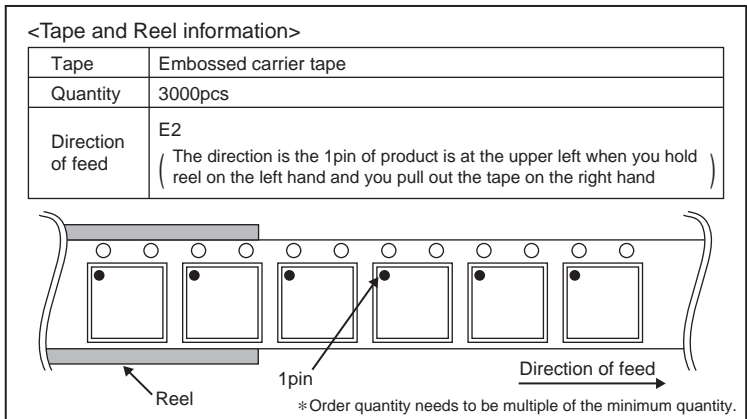
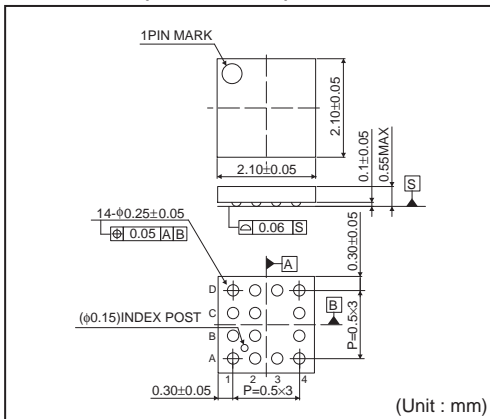

VCSP50L2(BD88415GUL)

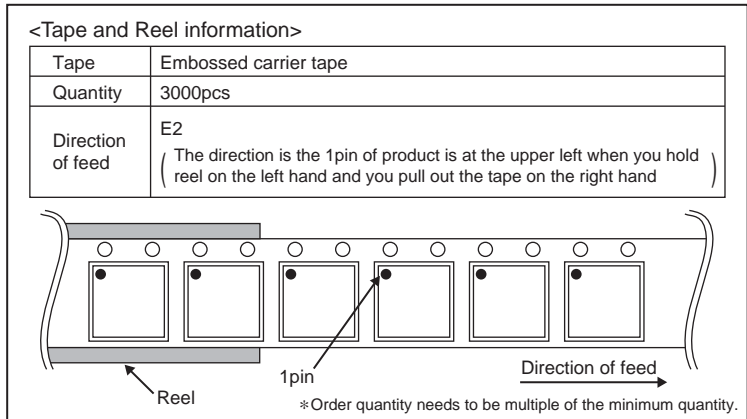
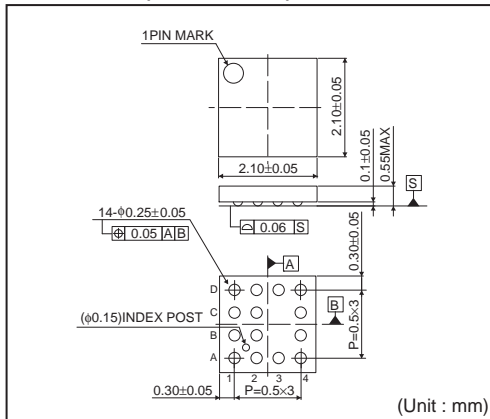

VCSP50L2(BD88420GUL)

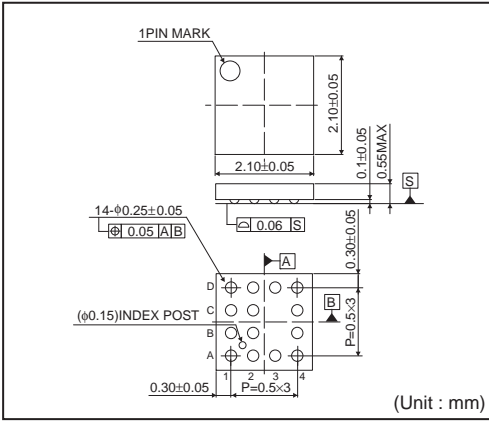

<Tape and Reel information>

Tape	Embossed carrier tape
Quantity	3000pcs
Direction of feed	E2 (The direction is the 1pin of product is at the upper left when you hold reel on the left hand and you pull out the tape on the right hand)



Notes

No copying or reproduction of this document, in part or in whole, is permitted without the consent of ROHM Co.,Ltd.

The content specified herein is subject to change for improvement without notice.

The content specified herein is for the purpose of introducing ROHM's products (hereinafter "Products"). If you wish to use any such Product, please be sure to refer to the specifications, which can be obtained from ROHM upon request.

Examples of application circuits, circuit constants and any other information contained herein illustrate the standard usage and operations of the Products. The peripheral conditions must be taken into account when designing circuits for mass production.

Great care was taken in ensuring the accuracy of the information specified in this document. However, should you incur any damage arising from any inaccuracy or misprint of such information, ROHM shall bear no responsibility for such damage.

The technical information specified herein is intended only to show the typical functions of and examples of application circuits for the Products. ROHM does not grant you, explicitly or implicitly, any license to use or exercise intellectual property or other rights held by ROHM and other parties. ROHM shall bear no responsibility whatsoever for any dispute arising from the use of such technical information.

The Products specified in this document are intended to be used with general-use electronic equipment or devices (such as audio visual equipment, office-automation equipment, communication devices, electronic appliances and amusement devices).

The Products specified in this document are not designed to be radiation tolerant.

While ROHM always makes efforts to enhance the quality and reliability of its Products, a Product may fail or malfunction for a variety of reasons.

Please be sure to implement in your equipment using the Products safety measures to guard against the possibility of physical injury, fire or any other damage caused in the event of the failure of any Product, such as derating, redundancy, fire control and fail-safe designs. ROHM shall bear no responsibility whatsoever for your use of any Product outside of the prescribed scope or not in accordance with the instruction manual.

The Products are not designed or manufactured to be used with any equipment, device or system which requires an extremely high level of reliability the failure or malfunction of which may result in a direct threat to human life or create a risk of human injury (such as a medical instrument, transportation equipment, aerospace machinery, nuclear-reactor controller, fuel-controller or other safety device). ROHM shall bear no responsibility in any way for use of any of the Products for the above special purposes. If a Product is intended to be used for any such special purpose, please contact a ROHM sales representative before purchasing.

If you intend to export or ship overseas any Product or technology specified herein that may be controlled under the Foreign Exchange and the Foreign Trade Law, you will be required to obtain a license or permit under the Law.



Thank you for your accessing to ROHM product informations.
More detail product informations and catalogs are available, please contact us.

ROHM Customer Support System

<http://www.rohm.com/contact/>



Стандарт Электрон Связь

Мы молодая и активно развивающаяся компания в области поставок электронных компонентов. Мы поставляем электронные компоненты отечественного и импортного производства напрямую от производителей и с крупнейших складов мира.

Благодаря сотрудничеству с мировыми поставщиками мы осуществляем комплексные и плановые поставки широчайшего спектра электронных компонентов.

Собственная эффективная логистика и склад в обеспечивает надежную поставку продукции в точно указанные сроки по всей России.

Мы осуществляем техническую поддержку нашим клиентам и предпродажную проверку качества продукции. На все поставляемые продукты мы предоставляем гарантию .

Осуществляем поставки продукции под контролем ВП МО РФ на предприятия военно-промышленного комплекса России , а также работаем в рамках 275 ФЗ с открытием отдельных счетов в уполномоченном банке. Система менеджмента качества компании соответствует требованиям ГОСТ ISO 9001.

Минимальные сроки поставки, гибкие цены, неограниченный ассортимент и индивидуальный подход к клиентам являются основой для выстраивания долгосрочного и эффективного сотрудничества с предприятиями радиоэлектронной промышленности, предприятиями ВПК и научно-исследовательскими институтами России.

С нами вы становитесь еще успешнее!

Наши контакты:

Телефон: +7 812 627 14 35

Электронная почта: sales@st-electron.ru

Адрес: 198099, Санкт-Петербург,
Промышленная ул, дом № 19, литера Н,
помещение 100-Н Офис 331