

# EA DOGS104-A

**INCL. CONTROLLER SSD1803A FOR SPI AND I<sup>2</sup>C**

available at 1 piece!  
Switchable font height



Dimension 36,0 x 27.5 x 4.6 mm

## TECHNICAL DATA

- \* HIGH-CONTRAST LCD SUPERTWIST DISPLAY
- \* OPTIONAL LED BACKLIGHT UNITS IN DIFFERENT COLORS
- \* 4x10 CHARACTER WITH 2.6 mm SWITCHABLE TO 2X10 WITH 4.55 mm HEIGHT
- \* SSD1803A CONTROLLER FOR SPI (2-/3-/4-WIRE) AND I<sup>2</sup>C (2-WIRE) INTERFACE
- \* SINGLE POWER SUPPLY +3.3V (typically 440µA)
- \* NO ADDITIONAL VOLTAGES REQUIRED
- \* OPERATING TEMPERATURE RANGE -20 THROUGH +70°C
- \* LED BACKLIGHT 3 THROUGH 45mA@3.3V
- \* NO MOUNTING REQUIRED, SIMPLY SOLDER INTO PCB
- \* 3 DIFFERENT CHARACTER SETS (CYRILLIC, ENGLISH-JAPANESE AND EUROPEAN) INCLUDED IN THE SAME CONTROLLER
- \* 2 VIEWING DIRECTION POSSIBLE (BOTTOM AND TOP VIEW)

## ORDERING CODE

LCD MODULE 4x10 - 2.6 mm

x: *B* = blue background

*W* = white background transfelctive

*N* = white background reflective

LED-BACKLIGHT AMBER

LED-BACKLIGHT YELLOW-GREEN / RED

LED-BACKLIGHT GREEN/ RED/ WHITE

**EA DOGS104x-A**

**EA LED36X28-A**

**EA LED36X28-GR**

**EA LED36X28-ERW**

## ACCESSORIES

USB-TESTBOARD FOR PC (WINDOWS)

SOCKET CONNECTOR 4,8mm HOCH (2 PCS REQUIRED)

**EA 9780-2USB**

**EA FL-10P**

**EA DOG SERIES**

With its EA DOG series, ELECTRONIC ASSEMBLY presents the world's first display series which will run on 3.3 V systems without auxiliary power.

Unlike normal LCD modules, you order the display and the corresponding backlight separately. This gives you a wealth of possible combinations.

Designed for compact hand-held devices, this modern LCD range provides a number of real benefits with or without backlight:

- \* extremely compact at 36,0x27,5 mm at the standard font size of 2.6 mm (4 x 10)
- \* ultra-flat at 2.0 mm without backlight or 4.6 mm including LED backlight
- \* SPI interface (2-/3-/4-wire) and I<sup>2</sup>C (2-wire)
- \* typical power consumption of only 440µA in full operation (LED white backlight as of 3mA)
- \* easy installation by simply soldering into the board
- \* A whole range of design variants can be supplied as of single units
- \* Changing background color

**LED BACKLIGHTS**

3 different variants are available for individual backlighting: amber, yellow-green/red, green/red/white.

For the amber backlight, 2 separate LED paths are available, which can be switched in parallel or in series to ideally match the system voltage. This means that all the backlights can be run either at 3.3 V and higher voltages.

Operation of the backlight requires an external series resistor for current limiting. This can be calculated by  $R=U/I$ ; you will find the values in the table. To improve life time it is recommended to use a current source only.

The operating life of the yellow/green, red and amber backlights is 100,000 hours and that of the white backlight is a bit shorter.

**Important:** Never operate the backlight directly on a 5 V/3.3V supply, as this can immediately destroy the LEDs!

amber EA LED36x28-A	Forward voltage	Current max.	Limiting resistor	
			@ 3,3 V	@ 5 V
Connected in parallel	2,1 V	60 mA	20 ohm	48 ohm
Connected in series	4,2 V	30 mA	-	27 ohm

green/red/white EA LED36X28-ERW	Forward voltage	Current max.	Limiting resistor	
			@ 3,3 V	@ 5 V
green path	3,0V	45 mA	7 ohm	45 ohm
red path	2,1 V	45 mA	27 ohm	65 ohm
white path	3,0 V	30 mA	10 ohm	67 ohm

yellowgreen/red EA LED36x28-GR	Forward voltage	Current max.	Limiting resistor	
			@ 3,3 V	@ 5 V
red path (AGR/CR)	2,1 V	45 mA	27 ohm	65 ohm
yellowgreen path (AGR/CG)	2,1 V	60 mA	20 ohm	48 ohm

**INSTALLATION**

First, the display and the corresponding backlight are clipped together. The complete unit is then inserted into a PCB and soldered. Note that the 4 pins for the backlight must also be soldered from the top with less tin.

**Important:** There are one or two protective films on the display (top and/or rear side) and one on each backlight. Those have to be removed during or after production.

EA LED36x28-A

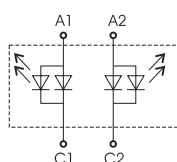

EA LED36x28-GR

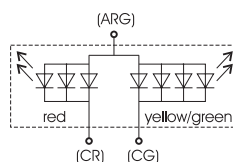

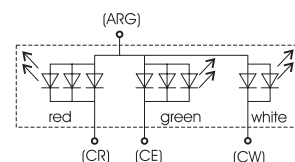

EA LED36x28-ERW



## EA DOGS104-A

### 4 DIFFERENT TECHNOLOGIES

As a standard we provide 3 different technologies as STN and FSTN:

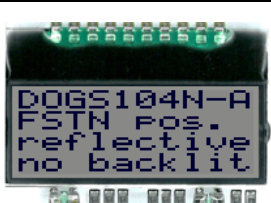
display type	technology	optional backlight	readability	display color non backlighted	display color backlighted	recommended backlight color
	FSTN pos. transfective	it's fine with and without backlight	readable even without backlight	black on white	black on backlight color	all
	STN neg. blue transmissive	usage only with backlight	---	---	white backlight on blue background	white
	FSTN pos. white reflective	no backlight possible	finest readable without backlight	black on white	---	---

### 3 DIFFERENT BACKLIGHTS

3 different backlight modules are available to match equipment's design as much as possible. The most effective and brightest one is the white part of EA LED36x28-ERW.



EA LED36x28-ERW  
Tri-color green red white



EA LED36x28-A  
Amber



EA LED36x28-GR  
Bi-color yellow-green red

When you can see black and white pictures only here on this page then you're able to download a coloured version from our website <http://www.lcd-module.de/eng/pdf/doma/dogs104e.pdf>

### USB-TEST BOARD EA 9780-2USB

For easy startup, a USB test board is available that can be connected to a PC. An USB cable and a Windows software is supplied with the product. This allows individual text and to be displayed directly on the connected display.

### SIMULATION WITH WINDOWS

Without ordering a display, the simulator software may show all the displays and colors even without the hardware. You can download for free from our website. There's no need to install, it's a simple EXE file, also running from USB stick e.g. [http://www.lcd-module.de/deu/disk/startdog\\_V40.zip](http://www.lcd-module.de/deu/disk/startdog_V40.zip)

**APPLICATION EXAMPLES**

Different wiring must be used depending on the interface.

Note that the COG technology means that the current capacity of the outputs is limited. Therefore, a large load on the bus may cause signal loops and unclean levels. If in doubt, additional pull-down resistors (8051) are required or additional waits/NOPs must be incorporated.

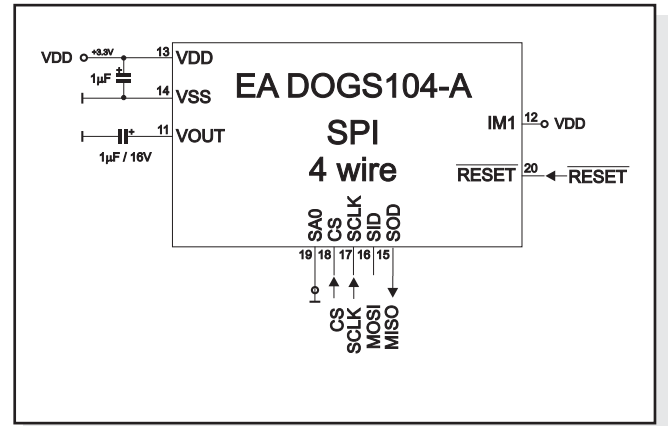

**INITIALISATION EXAMPLE**

Initialization Example SPI and I2C												
Command	RS	R/W	DB7	DB6	DB5	DB4	DB3	DB2	DB1	DB0	Hex	Remark
Function Set	0	0	0	0	1	1	1	0	1	0	\$3A	8 bit data length extension Bit RE=1; REV=0
Extended function set	0	0	0	0	0	0	1	0	0	1	\$09	4 line display
Entry mode set	0	0	0	0	0	0	0	1	1	0	\$06	bottom view
Bias setting	0	0	0	0	0	1	1	1	1	0	\$1E	BS1=1
Function Set	0	0	0	0	1	1	1	0	0	1	\$39	8 bit data length extension Bit RE=0; IS=1
Internal OSC	0	0	0	0	0	1	1	0	1	1	\$1B	BS0=1 -> Bias=1/6
Follower control	0	0	0	1	1	0	1	1	1	0	\$6E	Devicer on and set value
Power control	0	0	0	1	0	1	0	1	1	0	\$56	Booster on and set contrast (DB1=C5, DB0=C4)
Contrast Set	0	0	0	1	1	1	1	0	1	0	\$7A	Set contrast (DB3-DB0=C3-C0)
Function Set	0	0	0	0	1	1	1	0	1	0	\$38	8 bit data length extension Bit RE=0; IS=0
Display On	0	0	0	0	0	0	1	1	1	1	\$0F	Display on, cursor on, blink on

**12:00 VIEWING ANGLE, TOP VIEW OPTION**

If the display is read mostly from above (on the front of a laboratory power supply unit, for example), the preferred angle of viewing can be set to 12 o'clock. This rotates the display by 180°. A slightly different initialization setup is required for this. The line address is incremented by 10.

Change view												
Command	RS	R/W	DB7	DB6	DB5	DB4	DB3	DB2	DB1	DB0	Hex	Remark
Function Set	0	0	0	0	1	1	1	0	1	0	\$3A	8-Bit data length extension Bit RE=1; IS=0
Entry Mode	0	0	0	0	0	0	0	1	BDC	BDS	\$0X	\$06=bottom view, \$05 = top view
Function Set	0	0	0	0	1	1	1	0	0	0	\$38	8-Bit data length extension Bit RE=0; IS=0



Orientation 6:00 (Bottom View)



Orientation 12:00 (Top View)

**SETTING THE CONTRAST**

The contrast for the EA DOGS104-A can be set by command. This is done using bits C0 through C5 in the commands "Contrast Set" and "Power/Icon Control/Contrast Set". Generally, the contrast is set once only. Thanks to the integrated temperature compensation function, it's kept constant all over the entire operating temperature range (-20 to +70°C).

Contrast set												
Command	RS	R/W	DB7	DB6	DB5	DB4	DB3	DB2	DB1	DB0	Hex	Remark
Function Set	0	0	0	0	1	1	1	0	0	1	\$39	8-Bit data length extension Bit RE=0; IS=1
Power control	0	0	0	1	0	1	0	1	1	0	\$56	Booster on and set contrast (DB1=C5, DB0=C4)
Contrast Set	0	0	0	1	1	1	1	0	1	0	\$7A	Set contrast (DB3-DB0=C3-C0)
Function Set	0	0	0	0	1	1	1	0	1	0	\$38	8-Bit data length extension Bit RE=0; IS=0

**DDRAM ADDRESS / LINE COUNT**

The display controller SSD1803A affords the opportunity of double height fonts. The different line combinations with its corresponding initialization commands are shown in the following table. The DDRAM address depends on line count and viewing direction.

Bottom view	DDRAM ADDRESS	Top view	DDRAM ADDRESS	Set line count (RS = 0, R/W = 0)
	0x00 0x20 0x40 0x60		0x0A 0x2A 0x4A 0x6A	0x38 ->Function set: DH = 0
	0x00 0x20 0x40		0x0A 0x2A 0x4A	0x3A ->Function set: RE = 1 0x1F -> 3 Lines top 0x3C ->Function set: RE = 0, DH = 1
	0x00 0x20 0x40		0x0A 0x2A 0x4A	0x3A ->Function set: RE = 1 0x17 -> 3 Lines middle 0x3C ->Function set: RE = 0, DH = 1
	0x00 0x20 0x40		0x0A 0x2A 0x4A	0x3A ->Function set: RE = 1 0x13 -> 3 Lines bottom 0x3C ->Function set: RE = 0, DH = 1
	0x00 0x20		0x0A 0x2A	0x3A ->Function set: RE = 1 0x1B -> 2 Lines 0x3C ->Function set: RE = 0, DH = 1

Further information about the commands of the SSD1803A, please refer to the datasheet:  
[http://www.lcd-module.de/fileadmin/eng/pdf/zubehoer/ssd1803a\\_2\\_0.pdf](http://www.lcd-module.de/fileadmin/eng/pdf/zubehoer/ssd1803a_2_0.pdf)

**CHARACTER SET**

The controller has 3 built-in character sets. They can be selected with the command "ROM-Selection" in the extended command set.

**ROM A**

b3-0 b7-4	0 1 2 3 4 5 6 7 8 9 A B C D E F
00	
10	
20	
30	
40	
50	
60	
70	
80	
90	
A0	
B0	
C0	
D0	
E0	
F0	

**ROM B**

b3-0 b7-4	0 1 2 3 4 5 6 7 8 9 A B C D E F
00	
10	
20	
30	
40	
50	
60	
70	
80	
90	
A0	
B0	
C0	
D0	
E0	
F0	

**ROM C**

b3-0 b7-4	0 1 2 3 4 5 6 7 8 9 A B C D E F
00	
10	
20	
30	
40	
50	
60	
70	
80	
90	
A0	
B0	
C0	
D0	
E0	
F0	

Change character table												
Command	RS	RW	DB7	DB6	DB5	DB4	DB3	DB2	DB1	DB0	Hex	Remark
Function Set	0	0	0	0	1	1	1	0	1	0	\$3A	8-Bit data length extension Bit RE=1
ROM Selection	0	0	0	0	0	0	1	0	0	1	\$72	ROM selection double byte command
	1	0	0	0	0	0	R2	R1	0	0	\$0X	\$00 = ROMA; \$04=ROMB; \$0C=ROMC
Function Set	0	0	0	0	1	1	1	0	0	0	\$38	8-Bit data length extension Bit RE=0

**CREATING YOUR OWN CHARACTERS**

It's possible to create 8 own additional characters (ASCII Codes 0..7) to the fixes ROM codes

- 1.) The command "CG RAM Address Set" defines the ASCII code (Bit 3,4,5) and the dot line (Bit 0,1,2) of the new character. Example demonstrates creating ASCII code \$00.
- 2.) Doing 8 times the write command "Data Write" defines line by line the new character. 8th. byte stands for the cursor line.
- 3.) The new defined character can be used as a "normal" ASCII code (0..7); use with "DD RAM Address Set" and "Data Write".

Character-data									
Bit									Hex
7	6	5	4	3	2	1	0		
X	X	X	0	0	1	0	0	\$04	
			0	0	1	0	0	\$04	
			0	0	1	0	0	\$04	
			0	0	1	0	0	\$04	
			1	0	1	0	1	\$15	
			0	1	1	1	0	\$0E	
			0	0	1	0	0	\$04	
			0	0	0	0	0	\$00	

Define own character												
Command	RS	RW	DB7	DB6	DB5	DB4	DB3	DB2	DB1	DB0	Hex	Remark
CG-RAM address set	0	0	0	1	ACS	AC4	AC3	AC2	AC1	AC0	\$40	Set address of character \$40=0; \$48=1; \$54=2...\$78=7
Character-data	1	0	x	x	x	0	0	1	0	0	\$04	first line
						0	0	1	0	0	\$04	second line
						0	0	1	0	0	\$04	third line
						0	0	1	0	0	\$04	fourth line
						1	0	1	0	1	\$15	fifth line
						0	1	1	1	0	\$0E	sixth line
						0	0	1	0	0	\$04	seventh line
						0	0	0	0	0	\$00	eighth line, cursor line

## EA DOGS104-A

### SERIAL INTERFACE (SPI, MODE3)

The serial interface always needs a synchronization byte. In write mode, the byte to send has to be divided in two bytes, into the "lower data" and "upper data". Please refer to the chart below. The maximum clock frequency for SCLK is 1 MHz.

### SPI, 1-/2-/3-WIRE

With 2 to 4 lines SCLK, SID and CS, SOD (if necessary) the display EA DOGS104-A may be connected directly to the SPI interface of a  $\mu$ C.

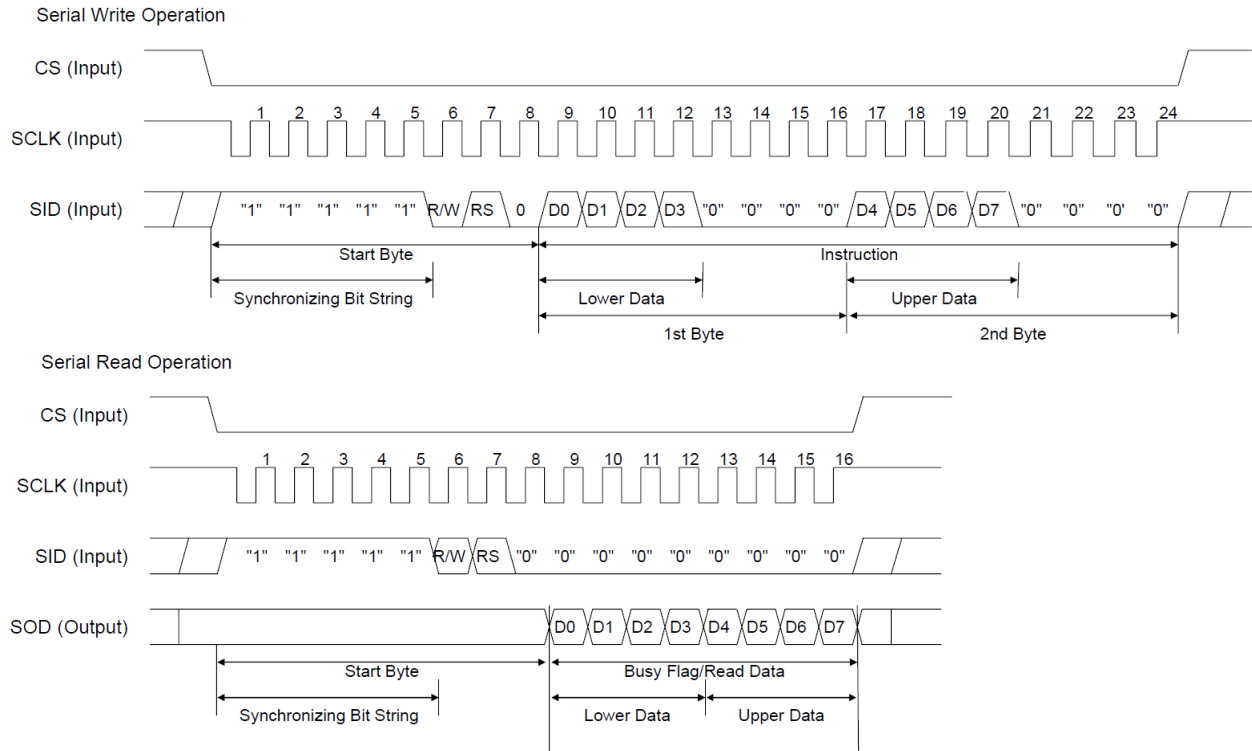

### I<sup>2</sup>C INTERFACE

The display can be assigned to the slave address 0x78 (SA0=0) or 0x7A (SA0=1). After transferring the start condition, the hardware address, together with the Read(1)/Write(0) bit has to be transmitted. While writing to the display, after the slave address, there always is a control byte holding the information Data(1) or Command(0) and the continuation bit. If the continuation bit is set to 0, the following bytes are data bytes until the next stop condition occurs. The maximum clock rate for I<sup>2</sup>C bus is 400 kHz.

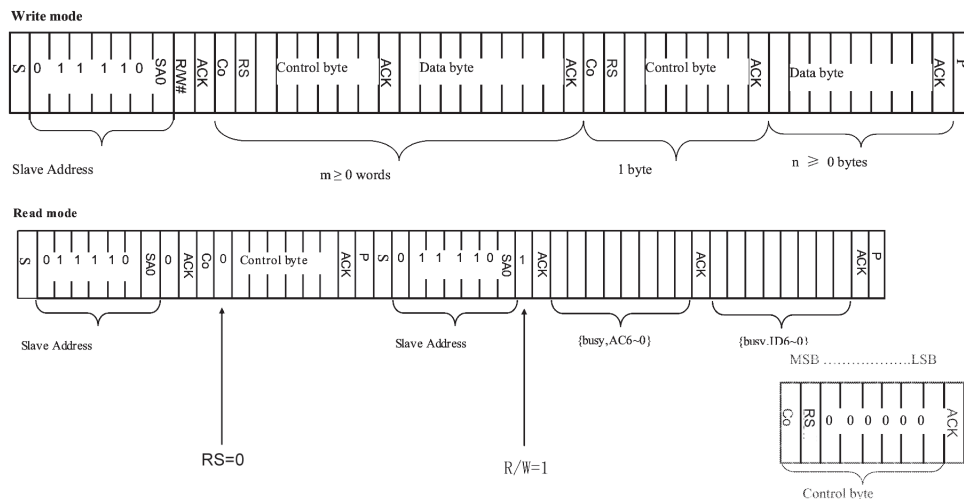

Further information about the interfaces and the timing of the SSD1803A, please refer to the datasheet [http://www.lcd-module.de/fileadmin/eng/pdf/zubehoer/ssd1803a\\_2\\_0.pdf](http://www.lcd-module.de/fileadmin/eng/pdf/zubehoer/ssd1803a_2_0.pdf)

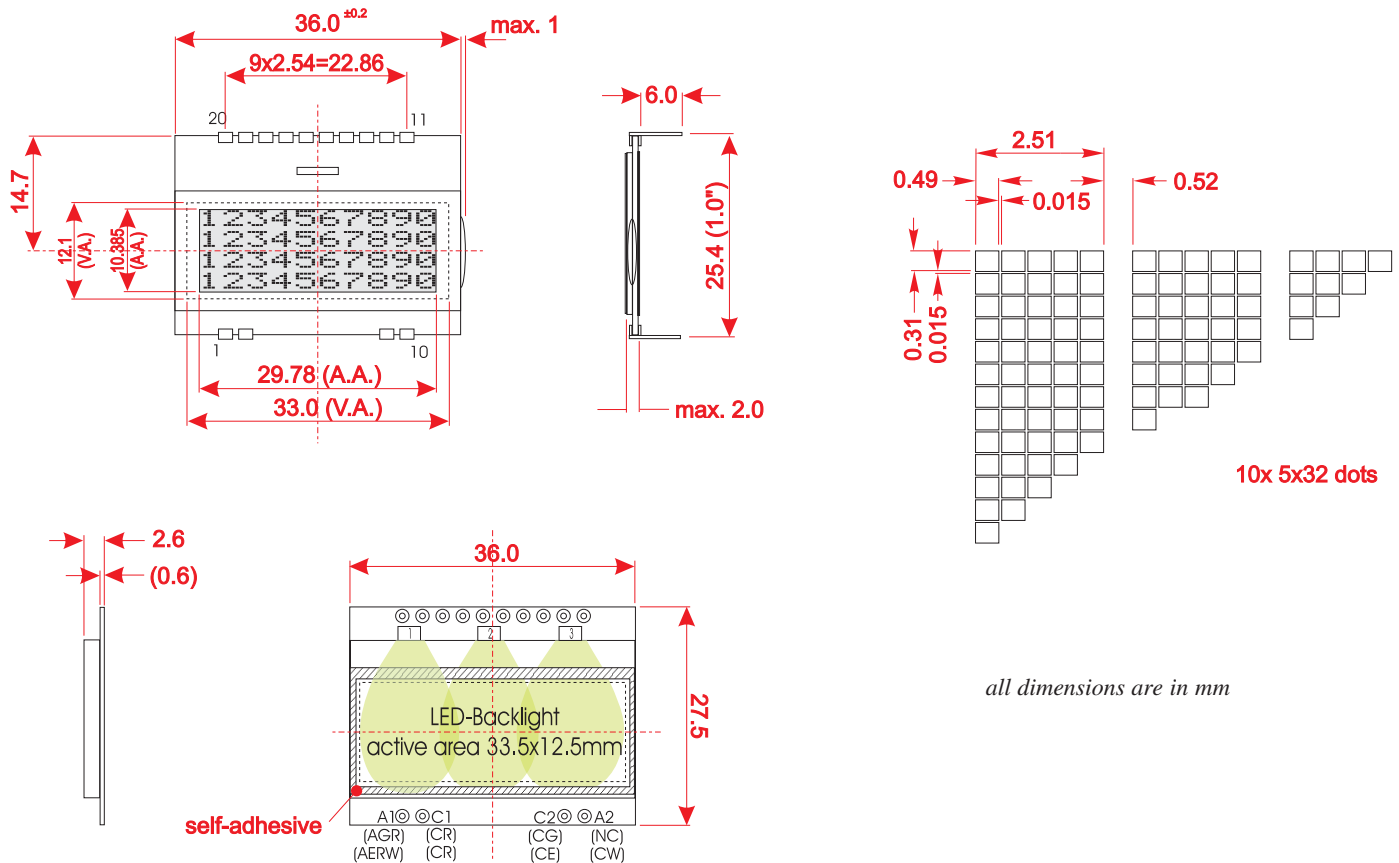

*Note:*  
 - LC-displays are not suited for wave soldering or reflow soldering. Temperatures above +80°C may damage LCD module.  
 - Surfaces of display and backlight are equipped with protection foils to be protected against scratching. Please remove before use.



Pin	Symbol	Level	Function	Pin	Symbol	Level	Function
1	NC		(A1: LED backlight)	20	RST	L	Reset
2	NC		(C1: LED backlight)	19	SA0	H/L	Slave Address
3				18	CS	L	Chip Select
4				17	SCLK	H/L	Serial Clock
5				16	SID	H/L	Serial Data In
6				15	SOD	H/L	Serial Data Out
7				14	VSS	L	GND
8				13	VDD	H	Power Supply +2.4..+3,6V
9	NC		(C2: LED backlight)	12	IM1	H/L	Mode H: SPI/ L: PC
10	NC		(A2: LED backlight)	11	VOUT	-	Output Voltage Converter

*Note:* The LED-Pins A1, C1, A2 und C2 (bzw. AGR, AERW, CG, CE, CR, CW) must be soldered from the top to ensure a clean contact.





**Стандарт  
Электрон  
Связь**

Мы молодая и активно развивающаяся компания в области поставок электронных компонентов. Мы поставляем электронные компоненты отечественного и импортного производства напрямую от производителей и с крупнейших складов мира.

Благодаря сотрудничеству с мировыми поставщиками мы осуществляем комплексные и плановые поставки широчайшего спектра электронных компонентов.

Собственная эффективная логистика и склад в обеспечивает надежную поставку продукции в точно указанные сроки по всей России.

Мы осуществляем техническую поддержку нашим клиентам и предпродажную проверку качества продукции. На все поставляемые продукты мы предоставляем гарантию .

Осуществляем поставки продукции под контролем ВП МО РФ на предприятия военно-промышленного комплекса России , а также работаем в рамках 275 ФЗ с открытием отдельных счетов в уполномоченном банке. Система менеджмента качества компании соответствует требованиям ГОСТ ISO 9001.

Минимальные сроки поставки, гибкие цены, неограниченный ассортимент и индивидуальный подход к клиентам являются основой для выстраивания долгосрочного и эффективного сотрудничества с предприятиями радиоэлектронной промышленности, предприятиями ВПК и научно-исследовательскими институтами России.

С нами вы становитесь еще успешнее!

**Наши контакты:**

**Телефон:** +7 812 627 14 35

**Электронная почта:** [sales@st-electron.ru](mailto:sales@st-electron.ru)

**Адрес:** 198099, Санкт-Петербург,  
Промышленная ул, дом № 19, литера Н,  
помещение 100-Н Офис 331