**FUNCTIONAL DIAGRAM**

## Octal D-Type Flip-Flop, 3-State Positive-Edge-Triggered

CD54/74AC/ACT564 - Inverting  
 CD54/74AC/ACT574 - Non-Inverting

**Type Features:**

- Buffered inputs
- Typical propagation delay:  
6.5 ns @  $V_{CC} = 5\text{ V}$ ,  $T_A = 25^\circ\text{C}$ ,  $C_L = 50\text{ pF}$

The RCA-CD54/74AC564 and CD54/74AC574 and the CD54/74ACT564 and CD54/74ACT574 octal D-type, 3-state, positive-edge-triggered flip-flops use the RCA ADVANCED CMOS technology. The eight flip-flops enter data into their registers on the LOW-to-HIGH transition of the clock (CP). The Output Enable ( $\overline{OE}$ ) controls the 3-state outputs and is independent of the register operation. When the Output Enable ( $\overline{OE}$ ) is HIGH, the outputs are in the high-impedance state. The CD54/74AC/ACT564 and CD54/74AC/ACT574 share the same pin configurations; the CD54/74AC/ACT564, however, has inverted outputs and the CD54/74AC/ACT574 has non-inverted outputs.

The CD74AC/ACT564 and CD74AC/ACT574 are supplied in 20-lead dual-in-line plastic packages (E suffix) and in 20-lead dual-in-line small-outline plastic packages (M suffix). Both package types are operable over the following temperature ranges: Commercial (0 to 70°C); Industrial (-40 to +85°C); and Extended Industrial/Military (-55 to +125°C).

The CD54AC/ACT564 and CD54AC/ACT574, available in chip form (H suffix), are operable over the -55 to +125°C temperature range.

**Family Features:**

- Exceeds 2-kV ESD Protection - MIL-STD-883, Method 3015
- SCR-Latchup-resistant CMOS process and circuit design
- Speed of bipolar FAST\*/AS/S with significantly reduced power consumption
- Balanced propagation delays
- AC types feature 1.5-V to 5.5-V operation and balanced noise immunity at 30% of the supply
- $\pm 24\text{-mA}$  output drive current
  - Fanout to 15 FAST\* ICs
  - Drives 50-ohm transmission lines

\*FAST is a Registered Trademark of Fairchild Semiconductor Corp.

**TRUTH TABLE**

INPUTS			OUTPUTS	
			564	574
$\overline{OE}$	CP	$D_n$	$\overline{Q_n}$	$Q_n$
L		H	L	H
L		L	H	L
L	L	X	$\overline{QO}$	QO
H	X	X	Z	Z

H = High level (steady state)

L = Low level (steady state)

X = Don't care

= Transition from low to high level

QO = The level of Q before the indicated steady-state input conditions were established

$\overline{QO}$  = The level of  $\overline{Q}$  before the indicated steady-state input conditions were established.

Z = High impedance

**9**

Technical Data

# CD54/74AC564, CD54/74AC574 CD54/74ACT564, CD54/74ACT574

**MAXIMUM RATINGS, Absolute-Maximum Values:**

DC SUPPLY-VOLTAGE ( $V_{CC}$ )	-0.5 to 6 V
DC INPUT DIODE CURRENT, $I_{IK}$ (for $V_I < -0.5$ V or $V_I > V_{CC} + 0.5$ V)	$\pm 20$ mA
DC OUTPUT DIODE CURRENT, $I_{OK}$ (for $V_O < -0.5$ V or $V_O > V_{CC} + 0.5$ V)	$\pm 50$ mA
DC OUTPUT SOURCE OR SINK CURRENT per Output Pin, $I_O$ (for $V_O > -0.5$ V or $V_O < V_{CC} + 0.5$ V)	$\pm 50$ mA
DC $V_{CC}$ or GROUND CURRENT ( $I_{CC}$ or $I_{GND}$ )	$\pm 100$ mA*
POWER DISSIPATION PER PACKAGE ( $P_D$ ):	
For $T_A = -55$ to $+100^\circ\text{C}$ (PACKAGE TYPE E)	500 mW
For $T_A = +100$ to $+125^\circ\text{C}$ (PACKAGE TYPE E)	Derate Linearly at 8 mW/ $^\circ\text{C}$ to 300 mW
For $T_A = -55$ to $+70^\circ\text{C}$ (PACKAGE TYPE M)	400 mW
For $T_A = +70$ to $+125^\circ\text{C}$ (PACKAGE TYPE M)	Derate Linearly at 6 mW/ $^\circ\text{C}$ to 70 mW
OPERATING-TEMPERATURE RANGE ( $T_A$ ):	-55 to $+125^\circ\text{C}$
STORAGE TEMPERATURE ( $T_{stg}$ )	-65 to $+150^\circ\text{C}$
LEAD TEMPERATURE (DURING SOLDERING):	
At distance $1/16 \pm 1/32$ in. ( $1.59 \pm 0.79$ mm) from case for 10 s maximum	$+265^\circ\text{C}$
Unit inserted into PC board min. thickness $1/16$ in. ( $1.59$ mm) with solder contacting lead tips only	$+300^\circ\text{C}$

\*For up to 4 outputs per device; add  $\pm 25$  mA for each additional output.

**RECOMMENDED OPERATING CONDITIONS:**

For maximum reliability, normal operating conditions should be selected so that operation is always within the following ranges:

CHARACTERISTIC	LIMITS		UNITS
	MIN.	MAX.	
Supply-Voltage Range, $V_{CC}$ *: (For $T_A =$ Full Package-Temperature Range) AC Types ACT Types	1.5 4.5	5.5 5.5	V V
DC Input or Output Voltage, $V_I, V_O$	0	$V_{CC}$	V
Operating Temperature, $T_A$ :	-55	+125	$^\circ\text{C}$
Input Rise and Fall Slew Rate, $dt/dv$ at 1.5 V to 3 V (AC Types) at 3.6 V to 5.5 V (AC Types) at 4.5 V to 5.5 V (ACT Types)	0 0 0	50 20 10	ns/V ns/V ns/V

\*Unless otherwise specified, all voltages are referenced to ground.

**TERMINAL ASSIGNMENT DIAGRAMS**

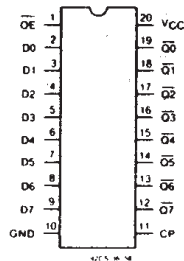

CD54/74AC/ACT564

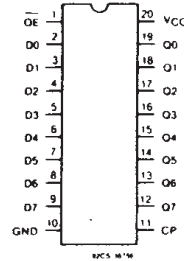

CD54/74AC/ACT574

Technical Data

# CD54/74AC564, CD54/74AC574 CD54/74ACT564, CD54/74ACT574

STATIC ELECTRICAL CHARACTERISTICS: AC Series

CHARACTERISTICS	TEST CONDITIONS		V <sub>CC</sub> (V)	AMBIENT TEMPERATURE (T <sub>a</sub> ) - °C						UNITS	
				+25		-40 to +85		-55 to +125			
	V <sub>i</sub> (V)	I <sub>o</sub> (mA)		MIN.	MAX.	MIN.	MAX.	MIN.	MAX.		
High-Level Input Voltage V <sub>IH</sub>			1.5	1.2	—	1.2	—	1.2	—	V	
			3	2.1	—	2.1	—	2.1	—		
			5.5	3.85	—	3.85	—	3.85	—		
Low-Level Input Voltage V <sub>IL</sub>			1.5	—	0.3	—	0.3	—	0.3	V	
			3	—	0.9	—	0.9	—	0.9		
			5.5	—	1.65	—	1.65	—	1.65		
High-Level Output Voltage V <sub>OH</sub>	V <sub>IH</sub> or V <sub>IL</sub>	#, *	-0.05	1.5	1.4	—	1.4	—	1.4	V	
			-0.05	3	2.9	—	2.9	—	2.9		
			-0.05	4.5	4.4	—	4.4	—	4.4		
			-4	3	2.58	—	2.48	—	2.4		
			-24	4.5	3.94	—	3.8	—	3.7		
			-75	5.5	—	—	3.85	—	—		
Low-Level Output Voltage V <sub>OL</sub>	V <sub>IH</sub> or V <sub>IL</sub>	#, *	0.05	1.5	—	0.1	—	0.1	—	V	
			0.05	3	—	0.1	—	0.1	—		
			0.05	4.5	—	0.1	—	0.1	—		
			12	3	—	0.36	—	0.44	—		0.5
			24	4.5	—	0.36	—	0.44	—		0.5
			75	5.5	—	—	—	1.65	—		—
Input Leakage Current I <sub>i</sub>	V <sub>CC</sub> or GND		5.5	—	±0.1	—	±1	—	±1	μA	
3-State Leakage Current I <sub>oz</sub>	V <sub>IH</sub> or V <sub>IL</sub> V <sub>O</sub> = V <sub>CC</sub> or GND		5.5	—	±0.5	—	±5	—	±10	μA	
Quiescent Supply Current, MSI I <sub>CC</sub>	V <sub>CC</sub> or GND	0	5.5	—	8	—	80	—	160	μA	

#Test one output at a time for a 1-second maximum duration. Measurement is made by forcing current and measuring voltage to minimize power dissipation.

\*Test verifies a minimum 50-ohm transmission-line-drive capability at +85°C. 75 ohms at +125°C.

9

# CD54/74AC564, CD54/74AC574 CD54/74ACT564, CD54/74ACT574

STATIC ELECTRICAL CHARACTERISTICS: ACT Series

CHARACTERISTICS	TEST CONDITIONS		V <sub>CC</sub> (V)	AMBIENT TEMPERATURE (T <sub>A</sub> ) - °C						UNITS	
				+25		-40 to +85		-55 to +125			
	V <sub>I</sub> (V)	I <sub>O</sub> (mA)		MIN.	MAX.	MIN.	MAX.	MIN.	MAX.		
High-Level Input Voltage	V <sub>IH</sub>		4.5 to 5.5	2	—	2	—	2	—	V	
Low-Level Input Voltage	V <sub>IL</sub>		4.5 to 5.5	—	0.8	—	0.8	—	0.8	V	
High-Level Output Voltage	V <sub>OH</sub>	V <sub>IH</sub> or V <sub>IL</sub> , #, *	-0.05	4.5	4.4	—	4.4	—	4.4	—	V
			-24	4.5	3.94	—	3.8	—	3.7	—	
			-75	5.5	—	—	3.85	—	—	—	
			-50	5.5	—	—	—	—	3.85	—	
Low-Level Output Voltage	V <sub>OL</sub>	V <sub>IH</sub> or V <sub>IL</sub> , #, *	0.05	4.5	—	±0.1	—	±1	—	±1	V
			24	4.5	—	0.36	—	0.44	—	0.5	
			75	5.5	—	—	—	1.65	—	—	
			50	5.5	—	—	—	—	—	1.65	
Input Leakage Current	I <sub>I</sub>	V <sub>CC</sub> or GND	5.5	—	±0.1	—	±1	—	±1	μA	
3-State Leakage Current	I <sub>OZ</sub>	V <sub>IH</sub> or V <sub>IL</sub> , V <sub>O</sub> = V <sub>CC</sub> or GND	5.5	—	±0.5	—	±5	—	±10	μA	
Quiescent Supply Current, MSI	I <sub>CC</sub>	V <sub>CC</sub> or GND	0	5.5	—	8	—	80	—	160	μA
Additional Quiescent Supply Current per Input Pin TTL Inputs High 1 Unit Load	ΔI <sub>CC</sub>	V <sub>CC</sub> -2.1	4.5 to 5.5	—	2.4	—	2.8	—	3	mA	

#Test one output at a time for a 1-second maximum duration. Measurement is made by forcing current and measuring voltage to minimize power dissipation.

\*Test verifies a minimum 50-ohm transmission-line-drive capability at +85°C, 75 ohms at +125°C.

ACT INPUT LOADING TABLE

INPUT	UNIT LOADS*
D, OE	0.7
CP	1.17

\*Unit load is ΔI<sub>CC</sub> limit specified in Static Characteristics Chart, e.g., 2.4 mA max. @ 25°C.

# CD54/74AC564, CD54/74AC574 CD54/74ACT564, CD54/74ACT574

PREREQUISITE FOR SWITCHING: AC Series

CHARACTERISTICS	SYMBOL	V <sub>CC</sub> (V)	AMBIENT TEMPERATURE (T <sub>A</sub> ) -°C				UNITS
			-40 to +85		-55 to +125		
			MIN.	MAX.	MIN.	MAX.	
Clock Pulse Width	t <sub>w</sub>	1.5	44	—	50	—	ns
		3.3*	4.9	—	5.6	—	
		5†	3.5	—	4	—	
Setup Time Data to Clock	t <sub>su</sub>	1.5	2	—	2	—	ns
		3.3	2	—	2	—	
		5	2	—	2	—	
Hold Time Data to Clock	t <sub>h</sub>	1.5	2	—	2	—	ns
		3.3	2	—	2	—	
		5	2	—	2	—	
Maximum Clock Frequency	f <sub>MAX</sub>	1.5	11	—	10	—	MHz
		3.3	101	—	89	—	
		5	143	—	125	—	

\*3.3 V: min. is @ 3 V  
†5 V: min. is @ 4.5 V

SWITCHING CHARACTERISTICS: AC Series; t<sub>r</sub>, t<sub>f</sub> = 3 ns, C<sub>L</sub> = 50 pF

CHARACTERISTICS	SYMBOL	V <sub>CC</sub> (V)	AMBIENT TEMPERATURE (T <sub>A</sub> ) -°C				UNITS
			-40 to +85		-55 to +125		
			MIN.	MAX.	MIN.	MAX.	
Propagation Delays: Clock to Q AC574	t <sub>PLH</sub> t <sub>PHL</sub>	1.5	—	123	—	135	ns
		3.3*	4	13.7	3.8	15.1	
		5†	2.9	9.8	2.7	10.8	
Clock to $\bar{Q}$ AC564	t <sub>PLH</sub> t <sub>PHL</sub>	1.5	—	128	—	141	ns
		3.3	4.1	14.4	4	15.8	
		5	2.9	10.3	2.8	11.3	
Output Enable to Q, $\bar{Q}$	t <sub>PZL</sub> t <sub>PZH</sub>	1.5	—	165	—	181	ns
		3.3	5.6	19.2	5.5	21.8	
		5	3.7	13.2	3.6	14.5	
Output Disable to Q, $\bar{Q}$	t <sub>PLZ</sub> t <sub>PHZ</sub>	1.5	—	165	—	181	ns
		3.3	4.7	16.5	4.5	18.1	
		5	3.7	13.2	3.6	14.5	
Power Dissipation Capacitance	C <sub>PD</sub> §	—	67 Typ.		67 Typ.		pF
Min. (Valley) V <sub>OH</sub> During Switching of Other Outputs (Output Under Test Not Switching)	V <sub>OHV</sub> See Fig. 1	5	4 Typ. @ 25°C				V
Max. (Peak) V <sub>OL</sub> During Switching of Other Outputs (Output Under Test Not Switching)	V <sub>OLP</sub> See Fig. 1	5	1 Typ. @ 25°C				V
Input Capacitance	C <sub>I</sub>	—	—	10	—	10	pF
3-State Output Capacitance	C <sub>O</sub>	—	—	15	—	15	pF

\*3.3 V: min. is @ 3.6 V  
max. is @ 3 V  
†5 V: min. is @ 5.5 V  
max. is @ 4.5 V

§C<sub>PD</sub> is used to determine the dynamic power consumption, per flip flop.  
P<sub>D</sub> = C<sub>PD</sub> V<sub>CC</sub><sup>2</sup> f<sub>i</sub> + Σ V<sub>CC</sub><sup>2</sup> f<sub>o</sub> C<sub>L</sub> where f<sub>i</sub> = input frequency  
f<sub>o</sub> = output frequency  
C<sub>L</sub> = output load capacitance  
V<sub>CC</sub> = supply voltage.

9

Technical Data

**CD54/74AC564, CD54/74AC574**  
**CD54/74ACT564, CD54/74ACT574**

PREREQUISITE FOR SWITCHING: ACT Series

CHARACTERISTICS	SYMBOL	V <sub>CC</sub> (V)	AMBIENT TEMPERATURE (T <sub>A</sub> ) -°C				UNITS
			-40 to +85		-55 to +125		
			MIN.	MAX.	MIN.	MAX.	
Clock Pulse Width	t <sub>w</sub>	5†	3.9	—	4.5	—	ns
Setup Time Data to Clock	t <sub>su</sub>	5	2	—	2	—	ns
Hold Time Data to Clock	t <sub>h</sub>	5	2.6	—	3	—	ns
Maximum Clock Frequency	f <sub>MAX</sub>	5	125	—	110	—	MHz

†5 V: min. is @ 4.5 V

SWITCHING CHARACTERISTICS: ACT Series; t<sub>r</sub>, t<sub>f</sub> = 3 ns, C<sub>L</sub> = 50 pF

CHARACTERISTICS	SYMBOL	V <sub>CC</sub> (V)	AMBIENT TEMPERATURE (T <sub>A</sub> ) -°C				UNITS
			-40 to +85		-55 to +125		
			MIN.	MAX.	MIN.	MAX.	
Propagation Delays: Clock to Q ACT574	t <sub>PLH</sub> t <sub>PHL</sub>	5†	2.9	10.2	2.8	11.2	ns
Clock to $\bar{Q}$ ACT564	t <sub>PLH</sub> t <sub>PHL</sub>	5	3	10.6	2.9	11.7	ns
Output Enable and Disable to Q ACT574	t <sub>PLZ</sub> t <sub>PHZ</sub> t <sub>PZL</sub> t <sub>PZH</sub>	5	3.7	13.2	3.6	14.5	ns
Output Enable and Disable to $\bar{Q}$ ACT564	t <sub>PLZ</sub> t <sub>PHZ</sub> t <sub>PZL</sub> t <sub>PZH</sub>	5	3.7	13.2	3.6	14.5	ns
Power Dissipation Capacitance	C <sub>PD</sub> §	—	67 Typ.		67 Typ.		pF
Min. (Valley) V <sub>OH</sub> During Switching of Other Outputs (Output Under Test Not Switching)	V <sub>OHV</sub> See Fig. 1	5	4 Typ. @ 25°C				V
Max. (Peak) V <sub>OL</sub> During Switching of Other Outputs (Output Under Test Not Switching)	V <sub>OLP</sub> See Fig. 1	5	1 Typ. @ 25°C				V
Input Capacitance	C <sub>I</sub>	—	—	10	—	10	pF
3-State Output Capacitance	C <sub>O</sub>	—	—	15	—	15	pF

†5 V: min. is @ 5.5 V  
 max. is @ 4.5 V

§C<sub>PD</sub> is used to determine the dynamic power consumption, per flip flop.

$$P_D = C_{PD} V_{CC}^2 f_i + \sum V_{CC}^2 f_o C_L + V_{CC} \Delta I_{CC}$$

where f<sub>i</sub> = input frequency  
 f<sub>o</sub> = output frequency  
 C<sub>L</sub> = output load capacitance  
 V<sub>CC</sub> = supply voltage.

# Technical Data

## CD54/74AC564, CD54/74AC574 CD54/74ACT564, CD54/74ACT574

### PARAMETER MEASUREMENT INFORMATION

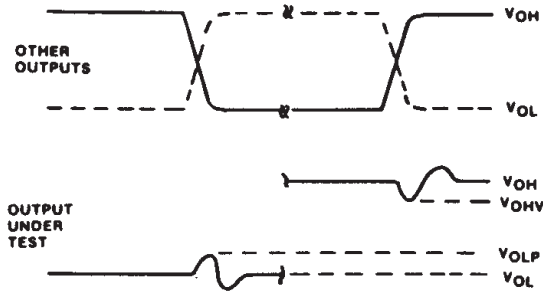

- NOTES:**
1.  $V_{OHV}$  and  $V_{OLP}$  ARE MEASURED WITH RESPECT TO A GROUND REFERENCE NEAR THE OUTPUT UNDER TEST.
  2. INPUT PULSES HAVE THE FOLLOWING CHARACTERISTICS:  
 $PRR \leq 1$  MHz,  $t_r = 3$  ns,  $t_f = 3$  ns, SKEW 1 ns.
  3. R.F. FIXTURE WITH 700-MHz DESIGN RULES REQUIRED.  
 IC SHOULD BE SOLDERED INTO TEST BOARD AND BYPASSED WITH 0.1  $\mu$ F CAPACITOR. SCOPE AND PROBES REQUIRE 700-MHz BANDWIDTH.

92CS-42406

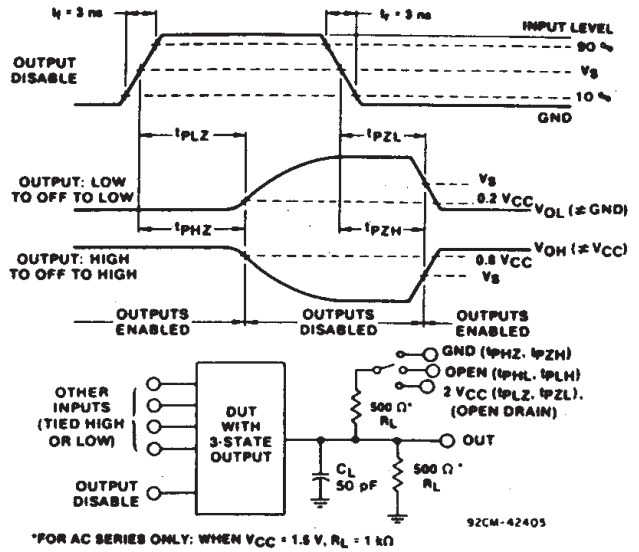
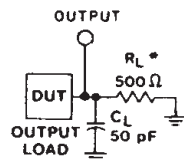
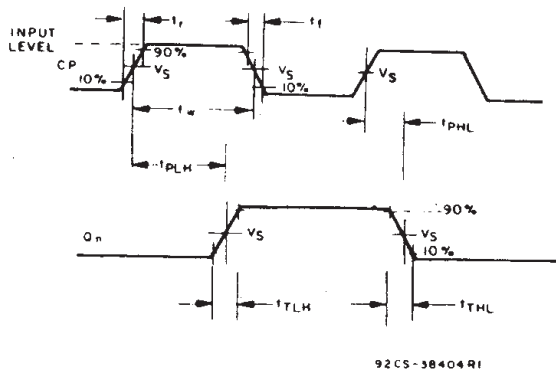

Fig. 1 - Simultaneous switching transient waveforms.

Fig. 2 - Three-state propagation delay waveforms and test circuit.



\*FOR AC SERIES ONLY: WHEN  
 $V_{CC} = 1.5$  V,  $R_L = 1$  k $\Omega$

92.S-42189

	CD54/74AC	CD54/74ACT
Input Level	$V_{CC}$	3 V
Input Switching Voltage, $V_S$	$0.5 V_{CC}$	1.5 V
Output Switching Voltage, $V_S$	$0.5 V_{CC}$	$0.5 V_{CC}$

Fig. 3 - Propagation delays times and test circuit.

**PACKAGING INFORMATION**

Orderable Device	Status (1)	Package Type	Package Drawing	Pins	Package Qty	Eco Plan (2)	Lead/Ball Finish	MSL Peak Temp (3)	Op Temp (°C)	Top-Side Markings (4)	Samples
CD54AC574F3A	ACTIVE	CDIP	J	20	1	TBD	A42	N / A for Pkg Type	-55 to 125	CD54AC574F3A	<a href="#">Samples</a>
CD54ACT574F3A	ACTIVE	CDIP	J	20	1	TBD	A42	N / A for Pkg Type	-55 to 125	CD54ACT574F3A	<a href="#">Samples</a>
CD74AC574E	ACTIVE	PDIP	N	20	20	Pb-Free (RoHS)	CU NIPDAU	N / A for Pkg Type	-55 to 125	CD74AC574E	<a href="#">Samples</a>
CD74AC574EE4	ACTIVE	PDIP	N	20	20	Pb-Free (RoHS)	CU NIPDAU	N / A for Pkg Type	-55 to 125	CD74AC574E	<a href="#">Samples</a>
CD74AC574M	ACTIVE	SOIC	DW	20	25	Green (RoHS & no Sb/Br)	CU NIPDAU	Level-1-260C-UNLIM	-55 to 125	AC574M	<a href="#">Samples</a>
CD74AC574M96	ACTIVE	SOIC	DW	20	2000	Green (RoHS & no Sb/Br)	CU NIPDAU	Level-1-260C-UNLIM	-55 to 125	AC574M	<a href="#">Samples</a>
CD74AC574M96E4	ACTIVE	SOIC	DW	20	2000	Green (RoHS & no Sb/Br)	CU NIPDAU	Level-1-260C-UNLIM	-55 to 125	AC574M	<a href="#">Samples</a>
CD74AC574M96G4	ACTIVE	SOIC	DW	20	2000	Green (RoHS & no Sb/Br)	CU NIPDAU	Level-1-260C-UNLIM	-55 to 125	AC574M	<a href="#">Samples</a>
CD74AC574ME4	ACTIVE	SOIC	DW	20	25	Green (RoHS & no Sb/Br)	CU NIPDAU	Level-1-260C-UNLIM	-55 to 125	AC574M	<a href="#">Samples</a>
CD74AC574MG4	ACTIVE	SOIC	DW	20	25	Green (RoHS & no Sb/Br)	CU NIPDAU	Level-1-260C-UNLIM	-55 to 125	AC574M	<a href="#">Samples</a>
CD74ACT574E	ACTIVE	PDIP	N	20	20	Pb-Free (RoHS)	CU NIPDAU	N / A for Pkg Type	-55 to 125	CD74ACT574E	<a href="#">Samples</a>
CD74ACT574EE4	ACTIVE	PDIP	N	20	20	Pb-Free (RoHS)	CU NIPDAU	N / A for Pkg Type	-55 to 125	CD74ACT574E	<a href="#">Samples</a>
CD74ACT574M	ACTIVE	SOIC	DW	20	25	Green (RoHS & no Sb/Br)	CU NIPDAU	Level-1-260C-UNLIM	-55 to 125	ACT574M	<a href="#">Samples</a>
CD74ACT574M96	ACTIVE	SOIC	DW	20	2000	Green (RoHS & no Sb/Br)	CU NIPDAU	Level-1-260C-UNLIM	-55 to 125	ACT574M	<a href="#">Samples</a>
CD74ACT574M96E4	ACTIVE	SOIC	DW	20	2000	Green (RoHS & no Sb/Br)	CU NIPDAU	Level-1-260C-UNLIM	-55 to 125	ACT574M	<a href="#">Samples</a>
CD74ACT574M96G4	ACTIVE	SOIC	DW	20	2000	Green (RoHS & no Sb/Br)	CU NIPDAU	Level-1-260C-UNLIM	-55 to 125	ACT574M	<a href="#">Samples</a>
CD74ACT574ME4	ACTIVE	SOIC	DW	20	25	Green (RoHS & no Sb/Br)	CU NIPDAU	Level-1-260C-UNLIM	-55 to 125	ACT574M	<a href="#">Samples</a>



Orderable Device	Status (1)	Package Type	Package Drawing	Pins	Package Qty	Eco Plan (2)	Lead/Ball Finish	MSL Peak Temp (3)	Op Temp (°C)	Top-Side Markings (4)	Samples
CD74ACT574MG4	ACTIVE	SOIC	DW	20	25	Green (RoHS & no Sb/Br)	CU NIPDAU	Level-1-260C-UNLIM	-55 to 125	ACT574M	<b>Samples</b>

(1) The marketing status values are defined as follows:

**ACTIVE:** Product device recommended for new designs.

**LIFEBUY:** TI has announced that the device will be discontinued, and a lifetime-buy period is in effect.

**NRND:** Not recommended for new designs. Device is in production to support existing customers, but TI does not recommend using this part in a new design.

**PREVIEW:** Device has been announced but is not in production. Samples may or may not be available.

**OBSOLETE:** TI has discontinued the production of the device.

(2) Eco Plan - The planned eco-friendly classification: Pb-Free (RoHS), Pb-Free (RoHS Exempt), or Green (RoHS & no Sb/Br) - please check <http://www.ti.com/productcontent> for the latest availability information and additional product content details.

**TBD:** The Pb-Free/Green conversion plan has not been defined.

**Pb-Free (RoHS):** TI's terms "Lead-Free" or "Pb-Free" mean semiconductor products that are compatible with the current RoHS requirements for all 6 substances, including the requirement that lead not exceed 0.1% by weight in homogeneous materials. Where designed to be soldered at high temperatures, TI Pb-Free products are suitable for use in specified lead-free processes.

**Pb-Free (RoHS Exempt):** This component has a RoHS exemption for either 1) lead-based flip-chip solder bumps used between the die and package, or 2) lead-based die adhesive used between the die and leadframe. The component is otherwise considered Pb-Free (RoHS compatible) as defined above.

**Green (RoHS & no Sb/Br):** TI defines "Green" to mean Pb-Free (RoHS compatible), and free of Bromine (Br) and Antimony (Sb) based flame retardants (Br or Sb do not exceed 0.1% by weight in homogeneous material)

(3) MSL, Peak Temp. -- The Moisture Sensitivity Level rating according to the JEDEC industry standard classifications, and peak solder temperature.

(4) Only one of markings shown within the brackets will appear on the physical device.

**Important Information and Disclaimer:** The information provided on this page represents TI's knowledge and belief as of the date that it is provided. TI bases its knowledge and belief on information provided by third parties, and makes no representation or warranty as to the accuracy of such information. Efforts are underway to better integrate information from third parties. TI has taken and continues to take reasonable steps to provide representative and accurate information but may not have conducted destructive testing or chemical analysis on incoming materials and chemicals. TI and TI suppliers consider certain information to be proprietary, and thus CAS numbers and other limited information may not be available for release.

In no event shall TI's liability arising out of such information exceed the total purchase price of the TI part(s) at issue in this document sold by TI to Customer on an annual basis.

**OTHER QUALIFIED VERSIONS OF CD54AC574, CD54ACT574, CD74AC574, CD74ACT574 :**

● Catalog: [CD74AC574](#), [CD74ACT574](#)

● Military: [CD54AC574](#), [CD54ACT574](#)

NOTE: Qualified Version Definitions:

- Catalog - TI's standard catalog product
- Military - QML certified for Military and Defense Applications

**TAPE AND REEL INFORMATION**

**QUADRANT ASSIGNMENTS FOR PIN 1 ORIENTATION IN TAPE**

\*All dimensions are nominal

Device	Package Type	Package Drawing	Pins	SPQ	Reel Diameter (mm)	Reel Width W1 (mm)	A0 (mm)	B0 (mm)	K0 (mm)	P1 (mm)	W (mm)	Pin1 Quadrant
CD74AC574M96	SOIC	DW	20	2000	330.0	24.4	10.8	13.0	2.7	12.0	24.0	Q1
CD74ACT574M96	SOIC	DW	20	2000	330.0	24.4	10.8	13.0	2.7	12.0	24.0	Q1

**TAPE AND REEL BOX DIMENSIONS**



\*All dimensions are nominal

Device	Package Type	Package Drawing	Pins	SPQ	Length (mm)	Width (mm)	Height (mm)
CD74AC574M96	SOIC	DW	20	2000	367.0	367.0	45.0
CD74ACT574M96	SOIC	DW	20	2000	367.0	367.0	45.0

J (R-GDIP-T\*\*)

14 LEADS SHOWN

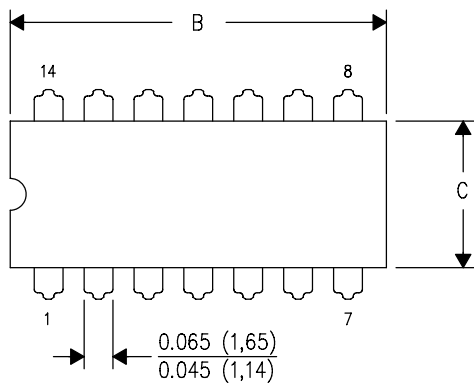
CERAMIC DUAL IN-LINE PACKAGE



DIM \ PINS **	14	16	18	20
A	0.300 (7,62) BSC	0.300 (7,62) BSC	0.300 (7,62) BSC	0.300 (7,62) BSC
B MAX	0.785 (19,94)	.840 (21,34)	0.960 (24,38)	1.060 (26,92)
B MIN	—	—	—	—
C MAX	0.300 (7,62)	0.300 (7,62)	0.310 (7,87)	0.300 (7,62)
C MIN	0.245 (6,22)	0.245 (6,22)	0.220 (5,59)	0.245 (6,22)



4040083/F 03/03

- NOTES:
- All linear dimensions are in inches (millimeters).
  - This drawing is subject to change without notice.
  - This package is hermetically sealed with a ceramic lid using glass frit.
  - Index point is provided on cap for terminal identification only on press ceramic glass frit seal only.
  - Falls within MIL STD 1835 GDIP1-T14, GDIP1-T16, GDIP1-T18 and GDIP1-T20.

N (R-PDIP-T\*\*)

PLASTIC DUAL-IN-LINE PACKAGE

16 PINS SHOWN

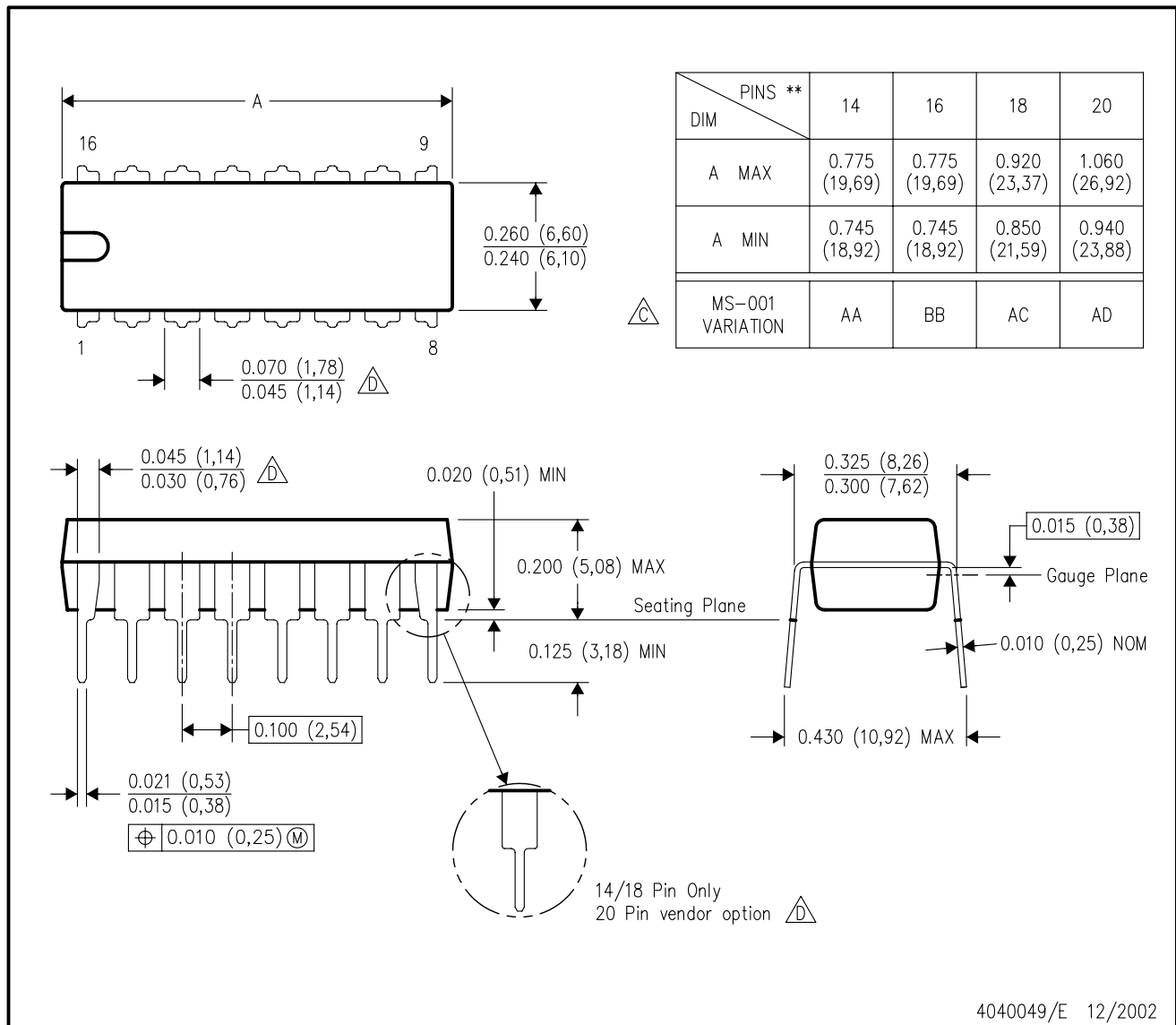

- NOTES:
- A. All linear dimensions are in inches (millimeters).
  - B. This drawing is subject to change without notice.
  - C Falls within JEDEC MS-001, except 18 and 20 pin minimum body length (Dim A).
  - D The 20 pin end lead shoulder width is a vendor option, either half or full width.

4040049/E 12/2002

DW (R-PDSO-G20)

PLASTIC SMALL OUTLINE

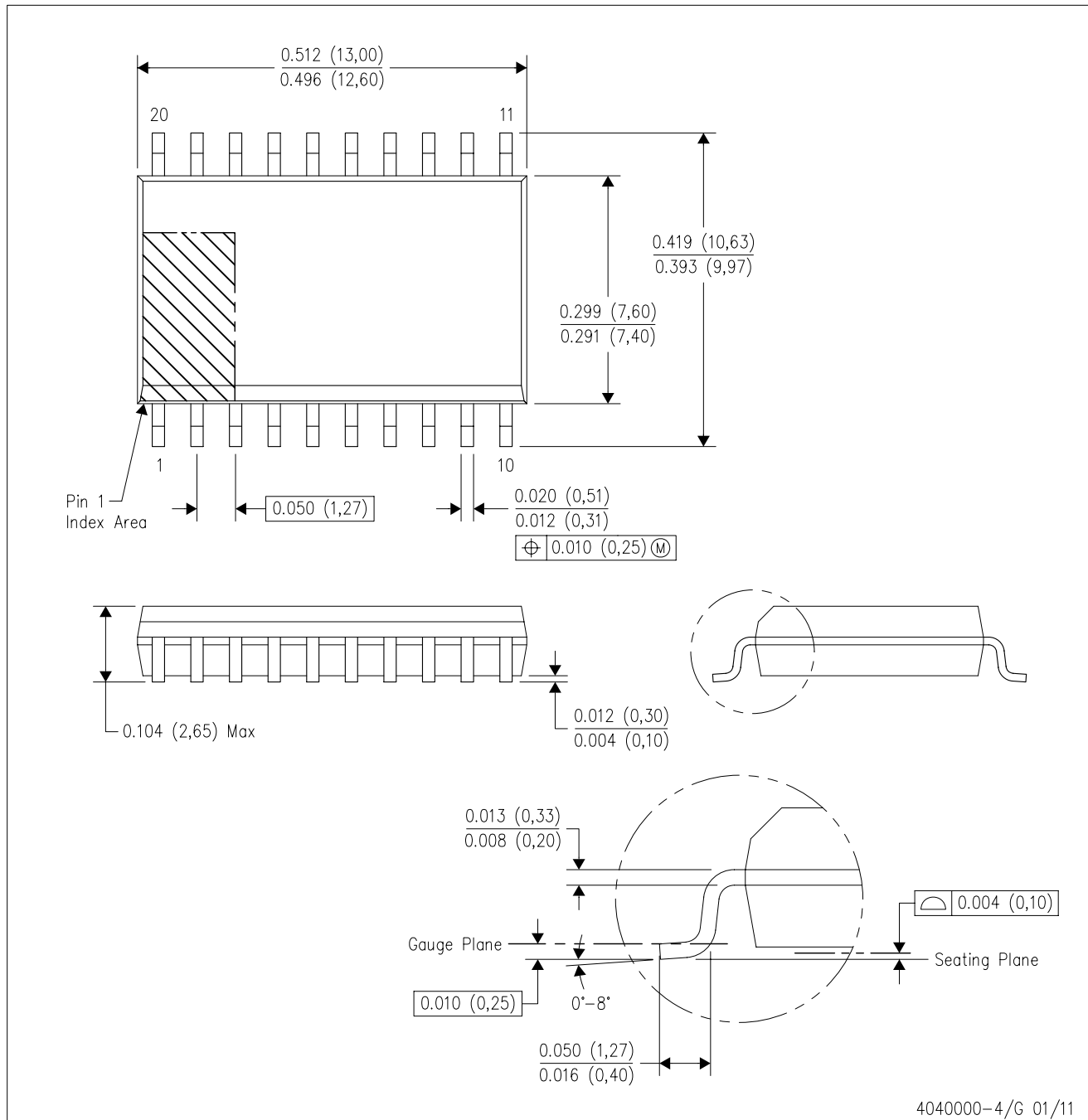

- NOTES:
- A. All linear dimensions are in inches (millimeters). Dimensioning and tolerancing per ASME Y14.5M-1994.
  - B. This drawing is subject to change without notice.
  - C. Body dimensions do not include mold flash or protrusion not to exceed 0.006 (0,15).
  - D. Falls within JEDEC MS-013 variation AC.

DW (R-PDSO-G20)

PLASTIC SMALL OUTLINE

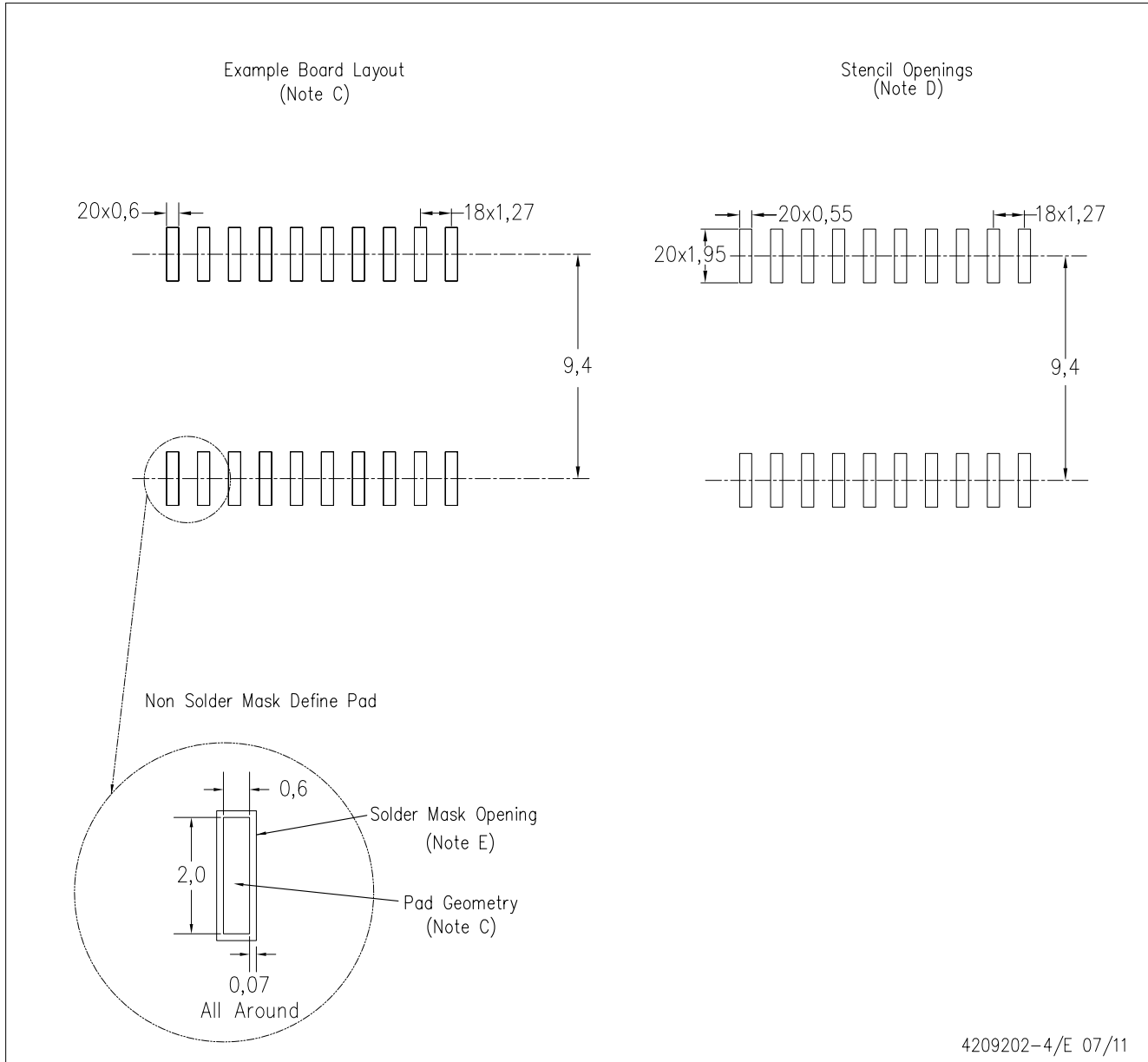

4209202-4/E 07/11

- NOTES:
- A. All linear dimensions are in millimeters.
  - B. This drawing is subject to change without notice.
  - C. Refer to IPC7351 for alternate board design.
  - D. Laser cutting apertures with trapezoidal walls and also rounding corners will offer better paste release. Customers should contact their board assembly site for stencil design recommendations. Refer to IPC-7525
  - E. Customers should contact their board fabrication site for solder mask tolerances between and around signal pads.



## IMPORTANT NOTICE

Texas Instruments Incorporated and its subsidiaries (TI) reserve the right to make corrections, enhancements, improvements and other changes to its semiconductor products and services per JESD46, latest issue, and to discontinue any product or service per JESD48, latest issue. Buyers should obtain the latest relevant information before placing orders and should verify that such information is current and complete. All semiconductor products (also referred to herein as "components") are sold subject to TI's terms and conditions of sale supplied at the time of order acknowledgment.

TI warrants performance of its components to the specifications applicable at the time of sale, in accordance with the warranty in TI's terms and conditions of sale of semiconductor products. Testing and other quality control techniques are used to the extent TI deems necessary to support this warranty. Except where mandated by applicable law, testing of all parameters of each component is not necessarily performed.

TI assumes no liability for applications assistance or the design of Buyers' products. Buyers are responsible for their products and applications using TI components. To minimize the risks associated with Buyers' products and applications, Buyers should provide adequate design and operating safeguards.

TI does not warrant or represent that any license, either express or implied, is granted under any patent right, copyright, mask work right, or other intellectual property right relating to any combination, machine, or process in which TI components or services are used. Information published by TI regarding third-party products or services does not constitute a license to use such products or services or a warranty or endorsement thereof. Use of such information may require a license from a third party under the patents or other intellectual property of the third party, or a license from TI under the patents or other intellectual property of TI.

Reproduction of significant portions of TI information in TI data books or data sheets is permissible only if reproduction is without alteration and is accompanied by all associated warranties, conditions, limitations, and notices. TI is not responsible or liable for such altered documentation. Information of third parties may be subject to additional restrictions.

Resale of TI components or services with statements different from or beyond the parameters stated by TI for that component or service voids all express and any implied warranties for the associated TI component or service and is an unfair and deceptive business practice. TI is not responsible or liable for any such statements.

Buyer acknowledges and agrees that it is solely responsible for compliance with all legal, regulatory and safety-related requirements concerning its products, and any use of TI components in its applications, notwithstanding any applications-related information or support that may be provided by TI. Buyer represents and agrees that it has all the necessary expertise to create and implement safeguards which anticipate dangerous consequences of failures, monitor failures and their consequences, lessen the likelihood of failures that might cause harm and take appropriate remedial actions. Buyer will fully indemnify TI and its representatives against any damages arising out of the use of any TI components in safety-critical applications.

In some cases, TI components may be promoted specifically to facilitate safety-related applications. With such components, TI's goal is to help enable customers to design and create their own end-product solutions that meet applicable functional safety standards and requirements. Nonetheless, such components are subject to these terms.

No TI components are authorized for use in FDA Class III (or similar life-critical medical equipment) unless authorized officers of the parties have executed a special agreement specifically governing such use.

Only those TI components which TI has specifically designated as military grade or "enhanced plastic" are designed and intended for use in military/aerospace applications or environments. Buyer acknowledges and agrees that any military or aerospace use of TI components which have **not** been so designated is solely at the Buyer's risk, and that Buyer is solely responsible for compliance with all legal and regulatory requirements in connection with such use.

TI has specifically designated certain components as meeting ISO/TS16949 requirements, mainly for automotive use. In any case of use of non-designated products, TI will not be responsible for any failure to meet ISO/TS16949.

### Products

Audio	<a href="http://www.ti.com/audio">www.ti.com/audio</a>
Amplifiers	<a href="http://amplifier.ti.com">amplifier.ti.com</a>
Data Converters	<a href="http://dataconverter.ti.com">dataconverter.ti.com</a>
DLP® Products	<a href="http://www.dlp.com">www.dlp.com</a>
DSP	<a href="http://dsp.ti.com">dsp.ti.com</a>
Clocks and Timers	<a href="http://www.ti.com/clocks">www.ti.com/clocks</a>
Interface	<a href="http://interface.ti.com">interface.ti.com</a>
Logic	<a href="http://logic.ti.com">logic.ti.com</a>
Power Mgmt	<a href="http://power.ti.com">power.ti.com</a>
Microcontrollers	<a href="http://microcontroller.ti.com">microcontroller.ti.com</a>
RFID	<a href="http://www.ti-rfid.com">www.ti-rfid.com</a>
OMAP Applications Processors	<a href="http://www.ti.com/omap">www.ti.com/omap</a>
Wireless Connectivity	<a href="http://www.ti.com/wirelessconnectivity">www.ti.com/wirelessconnectivity</a>

### Applications

Automotive and Transportation	<a href="http://www.ti.com/automotive">www.ti.com/automotive</a>
Communications and Telecom	<a href="http://www.ti.com/communications">www.ti.com/communications</a>
Computers and Peripherals	<a href="http://www.ti.com/computers">www.ti.com/computers</a>
Consumer Electronics	<a href="http://www.ti.com/consumer-apps">www.ti.com/consumer-apps</a>
Energy and Lighting	<a href="http://www.ti.com/energy">www.ti.com/energy</a>
Industrial	<a href="http://www.ti.com/industrial">www.ti.com/industrial</a>
Medical	<a href="http://www.ti.com/medical">www.ti.com/medical</a>
Security	<a href="http://www.ti.com/security">www.ti.com/security</a>
Space, Avionics and Defense	<a href="http://www.ti.com/space-avionics-defense">www.ti.com/space-avionics-defense</a>
Video and Imaging	<a href="http://www.ti.com/video">www.ti.com/video</a>

### TI E2E Community

[e2e.ti.com](http://e2e.ti.com)



## Стандарт Электрон Связь

Мы молодая и активно развивающаяся компания в области поставок электронных компонентов. Мы поставляем электронные компоненты отечественного и импортного производства напрямую от производителей и с крупнейших складов мира.

Благодаря сотрудничеству с мировыми поставщиками мы осуществляем комплексные и плановые поставки широчайшего спектра электронных компонентов.

Собственная эффективная логистика и склад в обеспечивает надежную поставку продукции в точно указанные сроки по всей России.

Мы осуществляем техническую поддержку нашим клиентам и предпродажную проверку качества продукции. На все поставляемые продукты мы предоставляем гарантию .

Осуществляем поставки продукции под контролем ВП МО РФ на предприятия военно-промышленного комплекса России , а также работаем в рамках 275 ФЗ с открытием отдельных счетов в уполномоченном банке. Система менеджмента качества компании соответствует требованиям ГОСТ ISO 9001.

Минимальные сроки поставки, гибкие цены, неограниченный ассортимент и индивидуальный подход к клиентам являются основой для выстраивания долгосрочного и эффективного сотрудничества с предприятиями радиоэлектронной промышленности, предприятиями ВПК и научно-исследовательскими институтами России.

С нами вы становитесь еще успешнее!

### Наши контакты:

**Телефон:** +7 812 627 14 35

**Электронная почта:** [sales@st-electron.ru](mailto:sales@st-electron.ru)

**Адрес:** 198099, Санкт-Петербург,  
Промышленная ул, дом № 19, литера Н,  
помещение 100-Н Офис 331