

Analog Devices Welcomes Hittite Microwave Corporation

NO CONTENT ON THE ATTACHED DOCUMENT HAS CHANGED



THIS PAGE INTENTIONALLY LEFT BLANK



GaAs MMIC ANALOG VARIABLE GAIN AMPLIFIER, 6 - 17 GHz

Typical Applications

The HMC694LP4(E) is ideal for:

- Point-to-Point Radio
- Point-to-Multi-Point Radio
- EW & ECM
- X-Band Radar
- Test Equipment

Features

- Wide Gain Control Range: 23 dB
- Single Control Voltage
- Output IP3 @ Max Gain: +30 dBm
- Output P1dB: +22 dBm
- No External Matching
- 24 Lead 4x4 mm SMT Package: 16 mm²

Functional Diagram

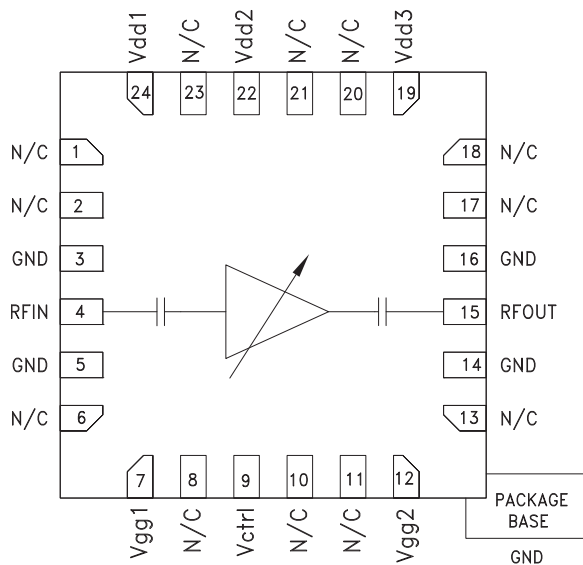

General Description

The HMC694LP4(E) is a GaAs MMIC PHEMT analog variable gain amplifier which operates between 6 and 17 GHz. Ideal for microwave radio applications, the amplifier provides up to 22 dB of gain, output P1 dB of up to +22 dBm, and up to +30 dBm of output IP3 at maximum gain, while requiring only 175 mA from a +5V supply. A gate bias pin (Vctrl) is provided to allow variable gain control up to 23 dB. Gain flatness is excellent making the HMC694LP4E ideal for EW, ECM and radar applications. The HMC694LP4E is housed in a RoHS compliant 4x4 mm QFN leadless package and is compatible with high volume surface mount manufacturing.

Electrical Specifications, $T_A = +25^\circ\text{C}$, $V_{dd1, 2, 3} = 5\text{V}$, $V_{ctrl} = -2\text{V}$, $I_{dd} = 170\text{mA}^*$

| Parameter | Min. | Typ. | Max. | Min. | Typ. | Max. | Units |
|--|------|---------|------|---------|-----------|------|--------|
| Frequency Range | | 6 - 10 | | 10 - 17 | | | GHz |
| Gain | 19 | 22 | | 14 | 18 | | dB |
| Gain Flatness | | ± 1 | | | ± 1.5 | | dB |
| Gain Variation Over Temperature | | 0.015 | | | 0.015 | | dB/ °C |
| Gain Control Range | | 23 | | | 20 | | dB |
| Noise Figure | | 6 | 7.5 | | 6 | 6.5 | dB |
| Input Return Loss | | 15 | | | 8 | | dB |
| Output Return Loss | | 10 | | | 8 | | dB |
| Output Power for 1 dB Compression (P1dB) | 19 | 21 | | 21 | 22 | | dBm |
| Saturated Output Power (Psat) | | 22 | | | 23 | | dBm |
| Output Third Order Intercept (IP3) | | 30 | | | 30 | | dBm |
| Total Supply Current (Idd) | | 175 | | | 175 | | mA |

*Set Vctrl = -2V and then adjust Vgg1, 2 between -2V to 0V (typ. -0.8V) to achieve Idd = 170mA typical.



GaAs MMIC ANALOG VARIABLE GAIN AMPLIFIER, 6 - 17 GHz

Control Voltage Range vs. Gain

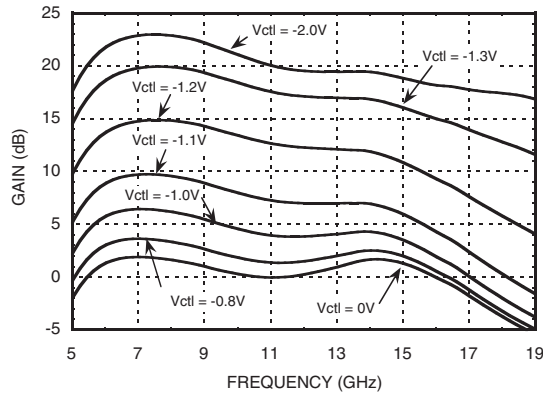

Gain vs. Control Voltage

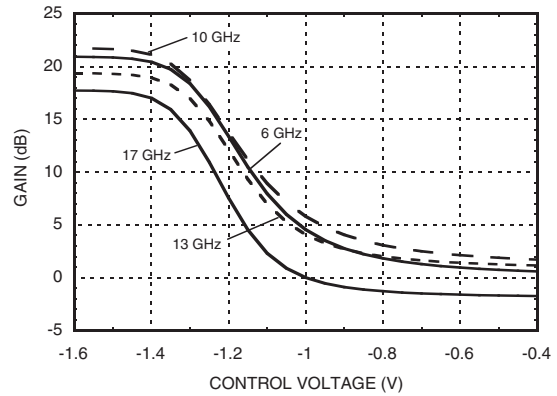

Broadband Gain & Return Loss

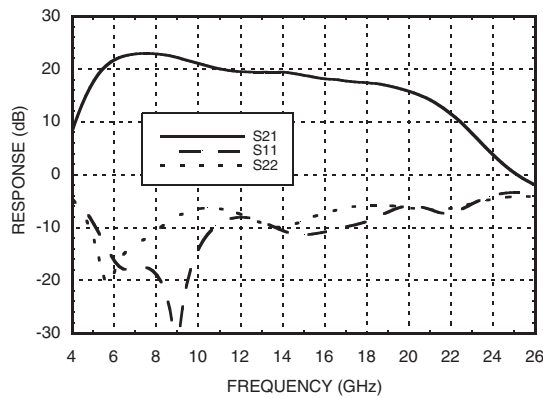

Gain vs. Temperature

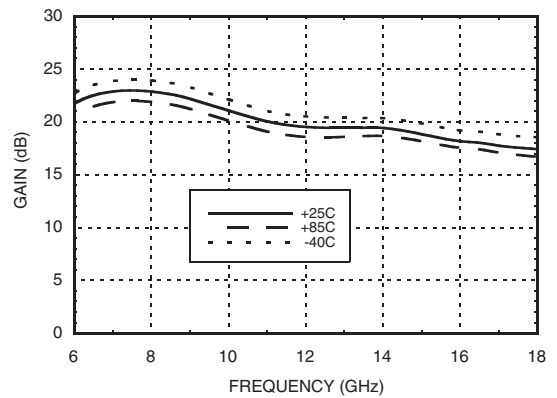

Input Return Loss vs. Temperature

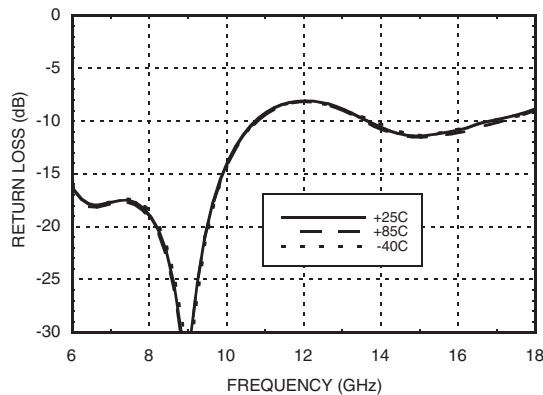

Output Return Loss vs. Temperature

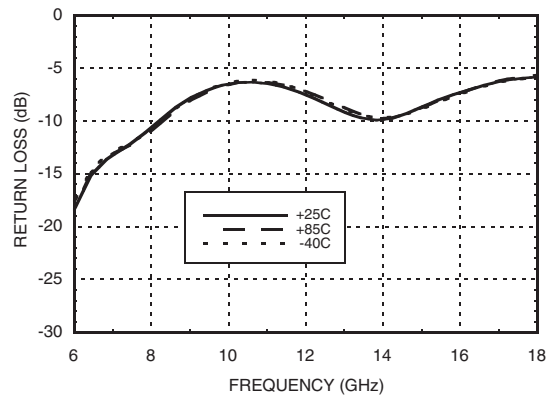

GaAs MMIC ANALOG VARIABLE GAIN AMPLIFIER, 6 - 17 GHz

Return Loss @ Voltage Extreme

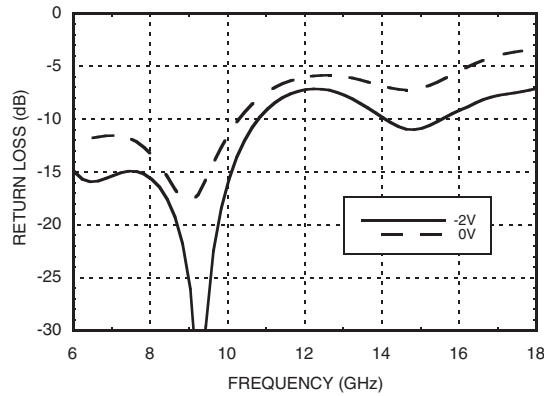

Output Return Loss @ Voltage Extreme

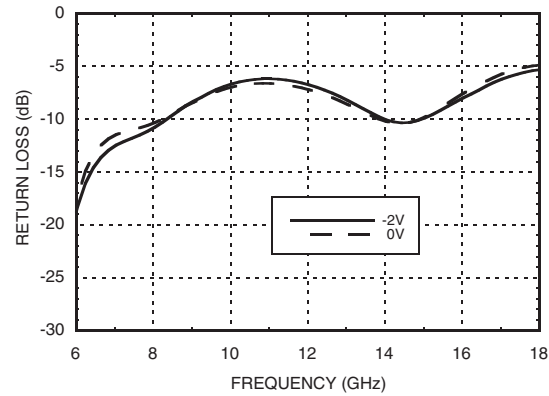

Noise Figure vs. Temperature

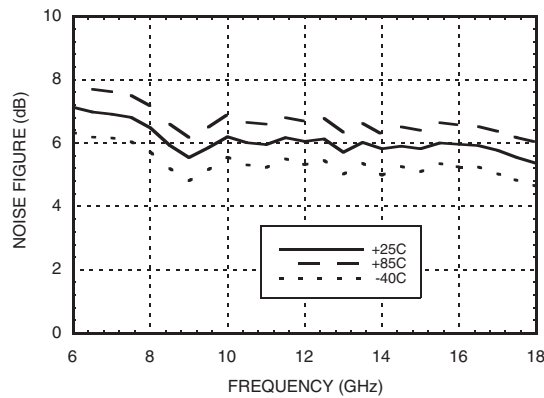

Noise Figure vs. CTRL

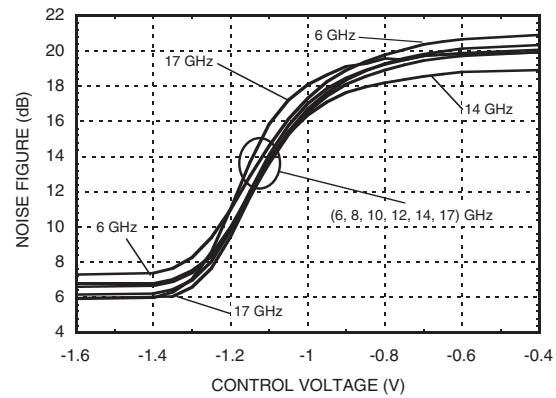

P1dB vs. Temperature

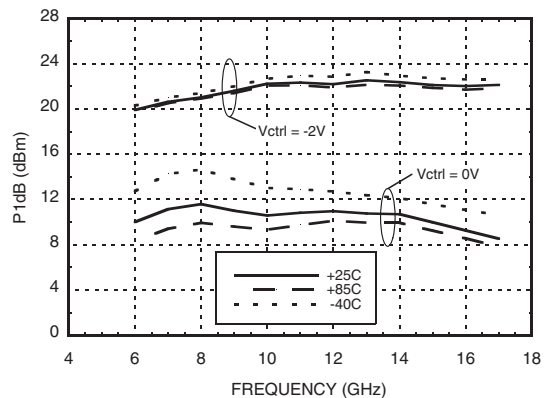

Psat vs. Temperature

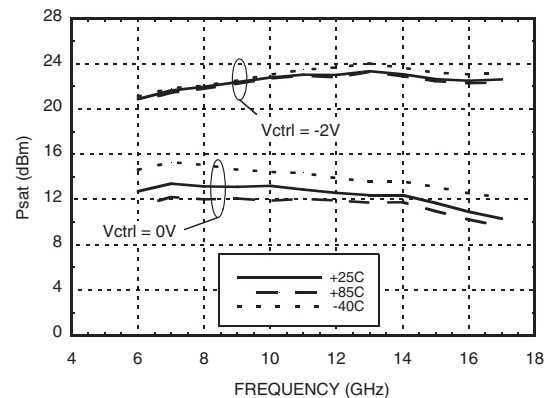

[1] Tested with broadband bias tee on RF ports and C1 = 10,000pF

[2] C1, C6 and C8 = 100pF, L1 = 24nF

Reverse Isolation vs. Temperature

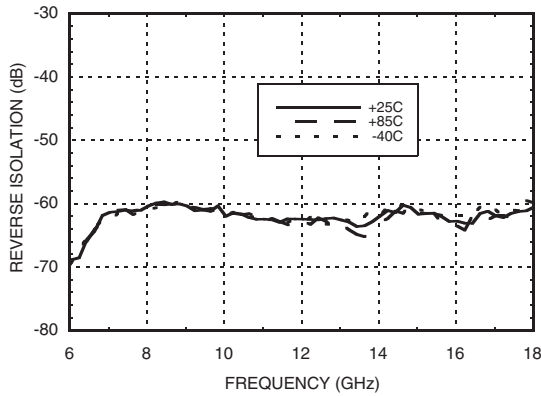

Output IP3 vs. Temperature

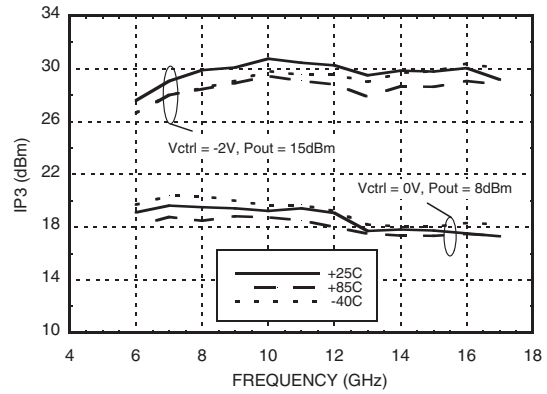

Output IP3 @ 0 dBm

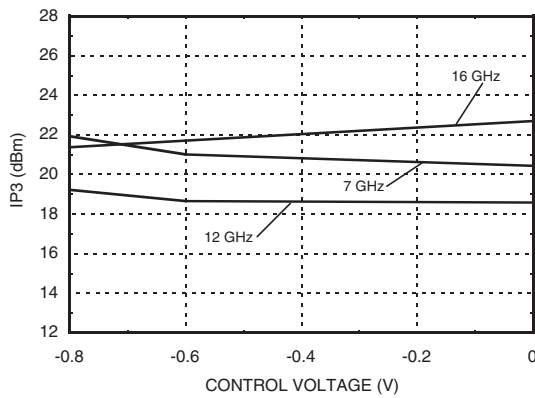

Output IP3 @ 5 dBm

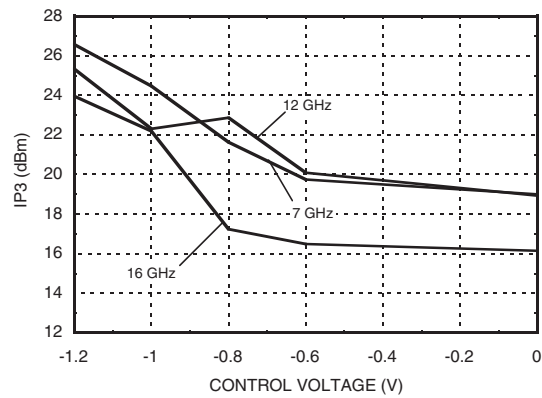

Output IP3 @ 10 dBm

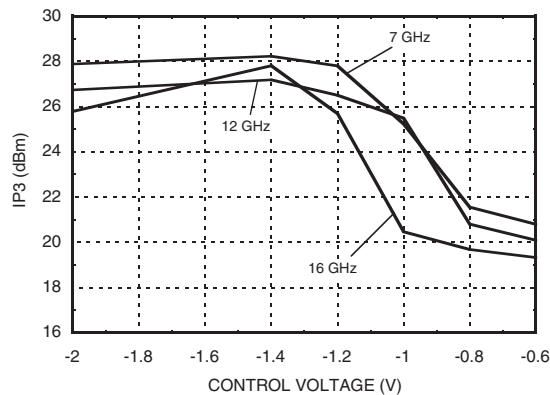

Absolute Maximum Ratings

| | |
|---|----------------|
| Drain Bias Voltage (Vdd1, 2, 3) | +5.5V |
| Gate Bias Voltage (Vgg1, 2) | -3 to 0V |
| Gain Control Voltage (Vctrl) | -3 to 0V |
| RF Power Input | +5 dBm |
| Channel Temperature | 175 °C |
| Continuous P _{diss} (T = 85 °C) (derate 10.2 mW/°C above 85 °C) [1] | 0.92 W |
| Thermal Resistance (Channel to ground paddle) | 97.6 °C/W |
| Storage Temperature | -65 to +150 °C |
| Operating Temperature | -40 to +85 °C |

Bias Voltage

| | |
|--------------|----------------------------|
| Vdd1,2,3 (V) | I _{dd} Total (mA) |
| +5.0 | 170 |
| Vgg1,2 (V) | I _{gg} Total (mA) |
| 0V to -2V | <3 μA |



ELECTROSTATIC SENSITIVE DEVICE
OBSERVE HANDLING PRECAUTIONS

Outline Drawing

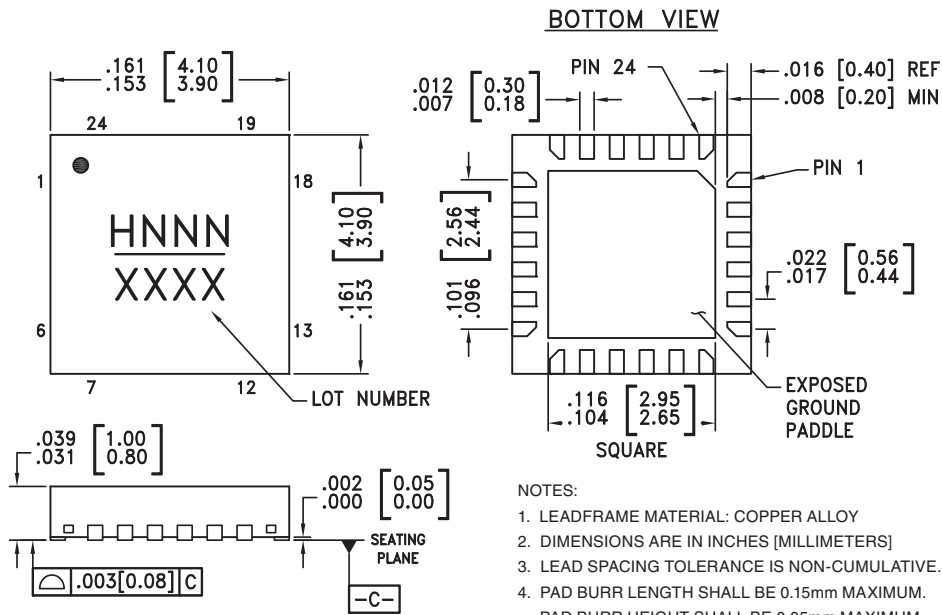

- NOTES:
- LEADFRAME MATERIAL: COPPER ALLOY
 - DIMENSIONS ARE IN INCHES [MILLIMETERS]
 - LEAD SPACING TOLERANCE IS NON-CUMULATIVE.
 - PAD BURR LENGTH SHALL BE 0.15mm MAXIMUM.
PAD BURR HEIGHT SHALL BE 0.05mm MAXIMUM.
 - PACKAGE WARP SHALL NOT EXCEED 0.05mm.
 - ALL GROUND LEADS AND GROUND PADDLE MUST BE SOLDERED TO PCB RF GROUND.
 - REFER TO HITTITE APPLICATION NOTE FOR SUGGESTED LAND PATTERN.

Package Information

| Part Number | Package Body Material | Lead Finish | MSL Rating | Package Marking [3] |
|-------------|--|---------------|------------|---------------------|
| HMC694LP4 | Low Stress Injection Molded Plastic | Sn/Pb Solder | MSL1 [1] | H694 XXXX |
| HMC694LP4E | RoHS-compliant Low Stress Injection Molded Plastic | 100% matte Sn | MSL1 [2] | H694 XXXX |

[1] Max peak reflow temperature of 235 °C

[2] Max peak reflow temperature of 260 °C

[3] 4-Digit lot number XXXX

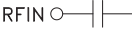
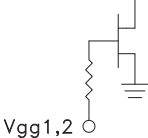
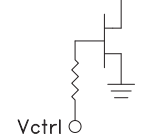
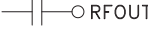
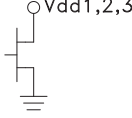

Pin Descriptions

| Pad Number | Function | Description | Interface Schematic |
|--|------------|--|---|
| 1, 2, 6, 8, 10, 11, 13, 17, 18, 20, 21, 23 | N/C | No Connection | |
| 3, 5, 14, 16 | GND | Die bottom must be connected to RF/DC ground. |  |
| 4 | RFIN | This pad is AC coupled and matched to 50 Ohm. |  |
| 7, 12 | Vgg1, 2 | Gate control for amplifier. Adjust voltage to achieve typical I _{dd} . Please follow "MMIC Amplifier Biasing Procedure" application note. |  |
| 9 | Vctrl | Gain control Voltage for the amplifier. See assembly diagram for required external components. |  |
| 15 | RFOUT | This pad is AC coupled and matched to 50 Ohm. |  |
| 19, 22, 24 | Vdd1, 2, 3 | Drain Bias Voltage for the amplifier. See assembly diagram for required external components |  |

Application Circuit

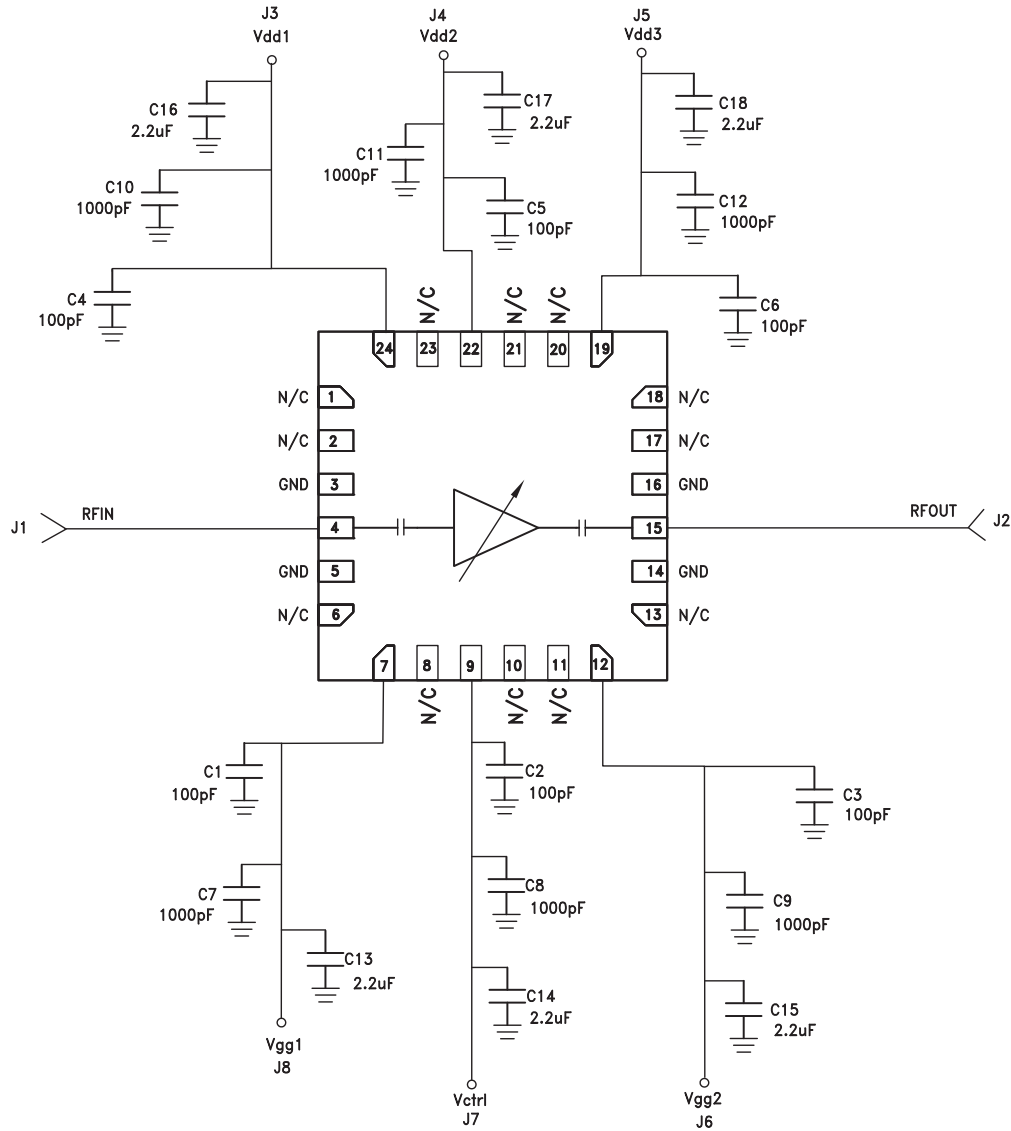

12

VARIABLE GAIN AMPLIFIERS - ANALOG - SMT

Evaluation PCB

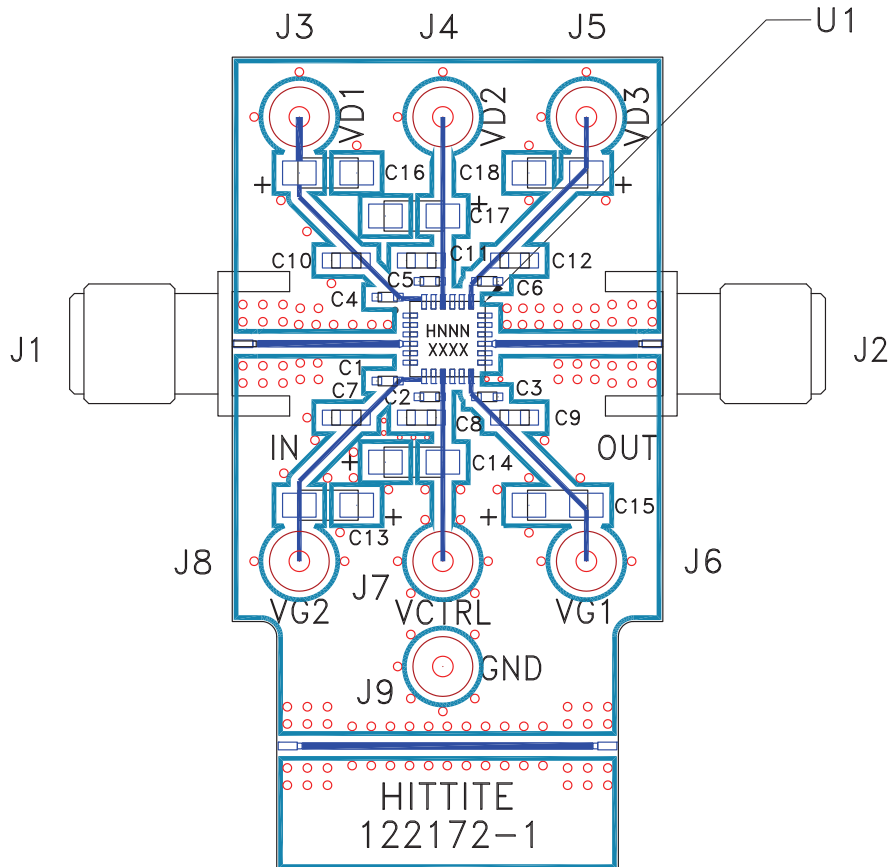

List of Materials for Evaluation PCB 122174 [1]

| Item | Description |
|-----------|--------------------------------------|
| J1, J2 | PCB Mount SMA RF Connectors |
| J3 - J9 | DC Pin |
| C1 - C6 | 100 pF Capacitor, 0402 Pkg. |
| C7 - C12 | 1000 pF Capacitor, 0603 Pkg. |
| C13 - C18 | 2.2 μF Capacitor, CASE A |
| U1 | HMC694LP4(E) Variable Gain Amplifier |
| PCB [2] | 122172 Evaluation PCB |

[1] Reference this number when ordering complete evaluation PCB

[2] Circuit Board Material: Arlon 25FR

The circuit board used in the application should use RF circuit design techniques. Signal lines should have 50 Ohm impedance while the package ground leads and exposed paddle should be connected directly to the ground plane similar to that shown. A sufficient number of via holes should be used to connect the top and bottom ground planes. The evaluation circuit board shown is available from Hittite upon request.



Стандарт Электрон Связь

Мы молодая и активно развивающаяся компания в области поставок электронных компонентов. Мы поставляем электронные компоненты отечественного и импортного производства напрямую от производителей и с крупнейших складов мира.

Благодаря сотрудничеству с мировыми поставщиками мы осуществляем комплексные и плановые поставки широчайшего спектра электронных компонентов.

Собственная эффективная логистика и склад в обеспечивает надежную поставку продукции в точно указанные сроки по всей России.

Мы осуществляем техническую поддержку нашим клиентам и предпродажную проверку качества продукции. На все поставляемые продукты мы предоставляем гарантию .

Осуществляем поставки продукции под контролем ВП МО РФ на предприятия военно-промышленного комплекса России , а также работаем в рамках 275 ФЗ с открытием отдельных счетов в уполномоченном банке. Система менеджмента качества компании соответствует требованиям ГОСТ ISO 9001.

Минимальные сроки поставки, гибкие цены, неограниченный ассортимент и индивидуальный подход к клиентам являются основой для выстраивания долгосрочного и эффективного сотрудничества с предприятиями радиоэлектронной промышленности, предприятиями ВПК и научно-исследовательскими институтами России.

С нами вы становитесь еще успешнее!

Наши контакты:

Телефон: +7 812 627 14 35

Электронная почта: sales@st-electron.ru

Адрес: 198099, Санкт-Петербург,
Промышленная ул, дом № 19, литера Н,
помещение 100-Н Офис 331