

N-Smart
Presence Detection Measurement

OMRON

Best Selection

Fiber Sensor Best Selection Catalog

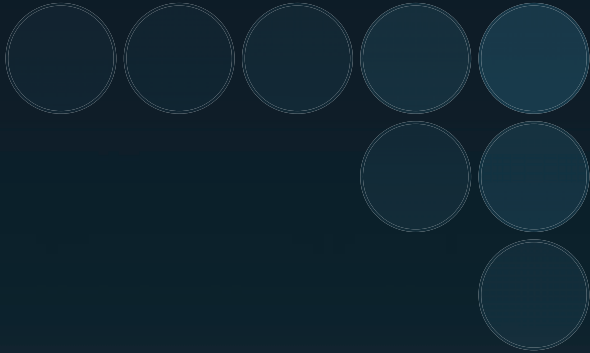

Start with Smart!

Easily select the most reliable Fiber Unit
for your detection conditions.



New Product Information

NEW

Build-in **Lens** series

Hex-shaped Fiber Units

→ 96 Page

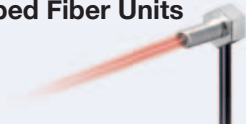

NEW

Smart Fiber Amplifier Units

E3NX-FA



NEW

Sensor Communications Units

E3NW



EtherCAT

CompoNet

CC-Link V2

realizing

Fiber Sensor
Features
2 Page

Selection
Guide
4 Page

Fiber Units
6 Page

Standard
Installation
6 Page

Saving
Space
14 Page

Beam Improvements
20 Page

Transparent
Objects
34 Page

Environmental
Immunity
38 Page

Applications
48 Page

Installation
Information
58 Page

Fiber Amplifiers,
Communications
Units, and Accessories
62 Page

Technical
Guide and
Precautions
90 Page

Model Index
98 Page

Easy

“Mounts Anywhere”

Wide Variety

Variouly-shaped, compact heads allow installation in any small space.

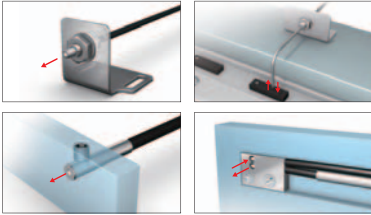

Suitable for Harsh Environments

Fiber Units are available for various installation conditions and can be installed as is, even in harsh environments.

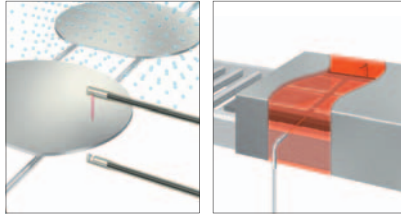

“Achieve Easy Detection in Many Applications”

Smart Tuning

Just press the button to set the optimum incident level and threshold. Consistent settings are achieved for all users with this ultra-easy procedure.



Automatic Setting of Optimum Values

Threshold + Incident Level

5000 9999

Set to the intermediate value between the incident levels with and without a workpiece.

Incident level adjustment with and without a workpiece

Optimum Light Intensity Adjustment from Transparent Objects to Black Workpieces

The incident level is optimized to enable stable detection even for saturated or insufficient incident levels.

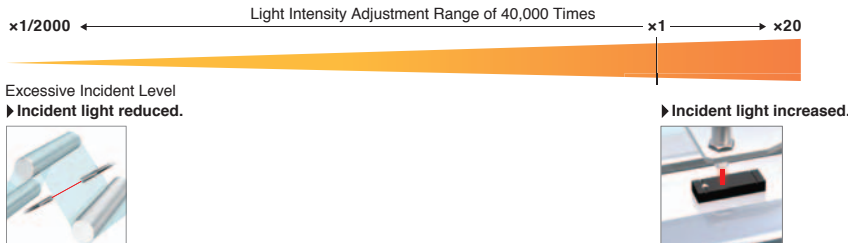

“Smooth Wiring and Setting”

Reduced Wiring

Simply link the Fiber Amplifier Units together for easy wiring and checking.

Separate Installation

Use the Distributed Sensor Unit for distributed installation to reduce introduction costs and work.

Easy Setup

Commissioning time is reduced with batch setting from a Touch Panel or backup data for process switchovers.



Optimal Fiber Sensor for additional
Fiber Units for various Installation Conditions,



NEW

Smart Fiber Amplifier Units E3NX-FA

62, 64
Page



Fiber

‘Easy’ and ‘Stable’ for

installation when starting production.
Fiber Amplifier Units with easy optimum setting

Stable

Fiber Units E32

06
Page



“Expanded Application Response Capabilities”

Improved Basic Performance

Improvements in the sensing distance and minimum sensing object increase the range of application for stable detection.

1.5 Times
the Sensing Distance*

6 m

For E32-LT11 Fiber Unit with a fiber length of 3.5 m

1/10th
the Minimum Sensing Object*

0.3 μm dia.

Typical example of actual measurements with E32-D11R Fiber Unit.

*Compared to E3X-HD.

NEW

Sensor Communications Units E3NW

EtherCAT

CompoNet

CC-Link V2

62, 64
Page

Basic Features of Fiber Sensors

Ideal for narrow spaces or for detecting minute objects.

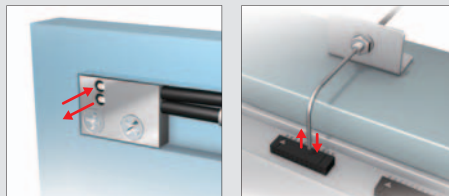

Digital display achieves visual control and quantitative control.

Conventional Photoelectric Sensor with Built-in Amplifier

Set the threshold by a sensitivity adjuster / Check the operation by an indicator.



- Ambiguous standard (e.g., 3/4 turn of adjuster)
- Indicator does not show the present value.

Fiber Sensor

Quantitative control over threshold settings with a digital display.



- The reference value can be set numerically for easier specification.
- Easily perceivable present value.

Sensor

Minimal Cost Process.

Selection by Category

STEP 1

Select a Fiber Unit.

Select a category.

Fiber Unit Index

05 Page

Select a model.

Category Pages

06 to 61 Page

STEP 2

Select a Fiber Amplifier Unit and Communications Unit.

62 Page

STEP 3



Select Accessories of Fiber Amplifier Unit

65,79 Page

Before Selecting Fiber Units

The Fiber Units specifications give the sensing distance when the Fiber Unit and Fiber Amplifier Unit is combined. Check the Fiber Amplifier Unit series for easier selection.

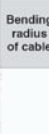
<Specifications on Each Fiber Unit Category Page>

Appearance (mm)	Bending radius of cable	Sensing distance (mm)				Optical axis diameter (minimum sensing object)	Models
		E3X-HD	Other modes	E3NX-FA	Other modes		
		GIGA HS	Other modes	GIGA HS	Other modes		E32-T11R 2M
		2,000	840	3,000	1,260		
		ST : 1,000	SHS : 280	ST : 1,500	SHS : 280		

Fiber Amplifier Unit Series

		E3X-HD Series	E3NX-FA Series NEW
Fiber Amplifier Unit specifications	Output	1 output	1 or 2 outputs (depending on the model)
	External input	Not supported	Supported or not supported (depending on the model)
	Response time	50 μs (55 μs)/250 μs/1 ms/16 ms (Default: 250 μs)	30 μs (32 μs)/250 μs/1 ms/16 ms (Default: 250 μs)
	Sensing distance (Giga-power mode)	E32-T11R: 2,000 mm E32-D11R: 840 mm	3,000 mm 1,260 mm
Minimum sensing object	E32-T11R: 5 μm dia.	2 μm dia.	
Sensor Communications Unit	Communications method (Sensor Communications Unit model)	EtherCAT (E3X-ECT) CompoNet (E3X-CRT)	EtherCAT (E3NW-ECT) CompoNet (E3NW-CRT) CC-Link (E3NW-CCL)
Unit application	Applicable Sensors	Fiber Sensor (E3X-HD0) Fiber Sensor (E3X-DA0-S, E3X-MDA0) Laser Photoelectric Sensor (E3C-LDA0) Proximity Sensor (E2C-EDA0)	Fiber Sensor (E3NX-FA0) Laser Sensors (E3NC-LA0, E3NC-SA0) Contact-Type Sensor (E9NC-TA0)*
Page listings	Ordering Information	78 Page	64 Page
	Ratings and Specifications	80 Page	66 Page
	Dimensions	80 Page	68 Page

* E3NW-CRT Sensor Communications Units (CompoNet) cannot be used.

Selection by Model

STEP 1

Search for the page in the model index.











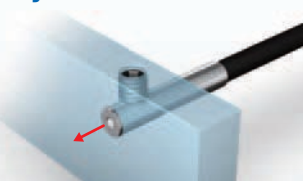

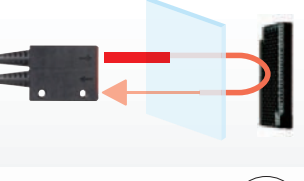

98 Page

STEP 2

Search for the model on the corresponding pages.

Each Page

Fiber Unit Index

Standard Installation		Saving Space	
Threaded Models  Standard screw-type installation. The Fiber Units is mounted into a drilled hole and secured with nuts. 06 Page	Cylindrical Models  Ideal for installation in narrow spaces. The Fiber Unit is secured with a set screw. 10 Page	Flat Models  Mount directly in limited spaces without using special mounting brackets. 14 Page	Sleeve Models (Close-range Detection)  Suitable for close-range detection. Ideal for detecting minute objects in areas with limited space. 16 Page
Beam Improvements			
Small-Spot, Reflective (Minute Object Detection)  Small-spot to accurately detect small objects. 20 Page	High-power Beam (Long-distance Installation, Dust-resistant)  Suitable for detection on large equipment, of large objects, and in environments with airborne particles. 24 Page	Narrow View (Detection Across Clearance)  The Fiber Unit emit a non-spreading beam to prevent false detection of light reflected off surrounding objects. 30 Page	Detection without Background Interference  Detect only objects in the sensing range, and not in the background. 32 Page
Transparent Object Detection			
Retro-reflective  Detect transparent objects reliably because the beam passes through the object twice, resulting in greater light interruption. 34 Page	Limited-reflective (Glass Detection)  The limited-reflective optical system provides stable detection of specular reflective glass. 36 Page		
Environmental Immunity			
Chemical-resistant, Oil-resistant  Made from materials that are resistant to various oils and chemicals. 38 Page	Bending-resistant, Disconnection-resistant  Resistant to repeated bending on moving parts and breaking from snagging or shock. 40 Page	Heat-resistant  Can be used in high-temperature environments at up to 400°C. 44 Page	
Special Applications			
Area Beam (Area Detection)  Detect across areas for meandering materials or falling workpieces whose position vary. 48 Page	Liquid-level Detection  Detect only liquid when being mounted on tubes or in liquid. 50 Page	Vacuum-resistant  Can be used under high vacuums of up to 10 ⁻³ Pa. 52 Page	FPD, Semiconductors, and Solar Cells  Designed specifically to reliably detect glass substrates and wafers. 54 Page

Fiber Sensor Features

Selection Guide

Fiber Units

Threaded	Standard Installation
Cylindrical	
Flat	
Sleeved	
Small Spot	Saving Space
High Power	
Narrow view	
BGS	Beam Improvements
Retro-reflective	
Limited-reflective	
Chemical-resistant, Oil-resistant	Transparent Objects
Bending	
Heat-resistant	
Area Detection	Environmental Immunity
Liquid-level	
Vacuum	
FPD, Semi, Solar	Applications
Installation Information	

Fiber Amplifiers, Communications Unit, and Accessories

Technical Guide and Precautions

Model Index

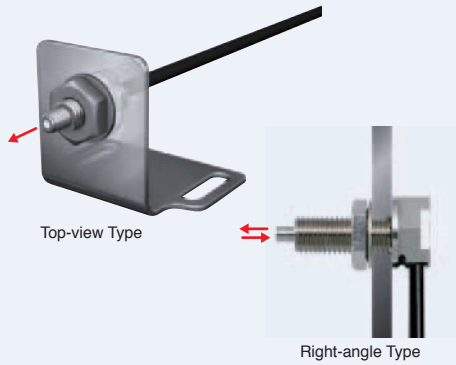

- Standard configuration. These Fiber Units are mounted into a hole drilled in a bracket and secured with nuts.
- The Right-angle Model prevents snagging on the cable because the cable runs along the mounting surface.

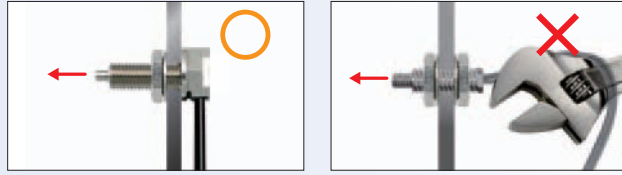

Hex-shaped Fiber Units with Build-in Lenses [Build-in Lens](#) have been added to the series. (They have a right-angle shape like that of the E32-T11N shown below.)
→ 96 Page

Specifications

Through-beam Fiber Units

Sensing direction (Aperture angle)	Size	Appearance (mm)	Bending radius of cable	Sensing distance (mm)				Optical axis diameter (minimum sensing object)	Models	07 Page Dimensions No.
				E3X-HD		E3NX-FA NEW				
				GIGA	HS	GIGA	HS			
Right-angle (Approx. 60°)	M4		Flexible, R1	2,000	ST : 1,000	3,000	ST : 1,500	1 dia. (5 μm dia./ 2 μm dia.)	E32-T11N 2M	07-A
				700	SHS : 280	1,050	SHS : 280			
Top-view (Approx. 60°)	M4		R25	4,000*	ST : 4,000*	4,000*	ST : 4,000*	2.3 dia. (0.1 dia./ 0.03 dia.)	E32-LT11 2M NEW	07-C
				2,700	SHS : 1,080	4,000*	SHS : 1,080			
Top-view (Approx. 15°)	M4		Flexible, R1	4,000*	ST : 3,500	4,000*	ST : 4,000*	E32-LT11R 2M NEW		
				2,300	SHS : 920	3,450	SHS : 920			

* The optical fiber is 2 m long on each side, so the sensing distance is 4,000 mm.

Note 1. The following mode names and response times apply to the modes given in the Sensing distance column.

[E3X-HD] GIGA: Giga-power mode (16 ms), HS: High-speed mode (250 μs), ST: Standard mode (1 ms), and SHS: Super-high-speed mode (NPN output: 50 μs, PNP output: 55 μs)
[E3NX-FA] GIGA: Giga-power mode (16 ms), HS: High-speed mode (250 μs), ST: Standard mode (1 ms), and SHS: Super-high-speed mode (30 μs)

2. The values for the minimum sensing object are reference values that indicate values obtained in standard mode with the sensing distance and sensitivity set to the optimum values. The first value is for the E3X-HD and the second value is for the E3NX-FA.

Dimensions

Installation Information → 59, 60 Page

Through-beam Fiber Units (Set of 2)

07-A E32-T11N 2M (Free Cutting)

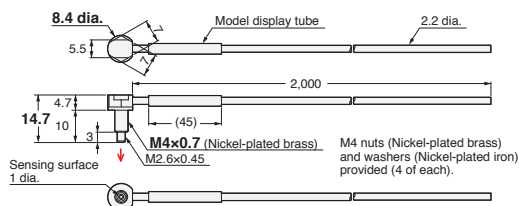

07-B E32-T11R 2M (Free Cutting)

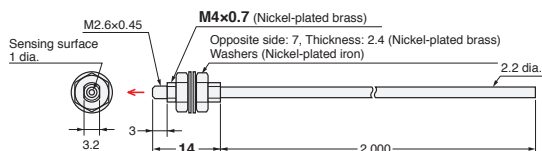

07-C E32-LT11 2M (Free Cutting)

E32-LT11R 2M (Free Cutting)

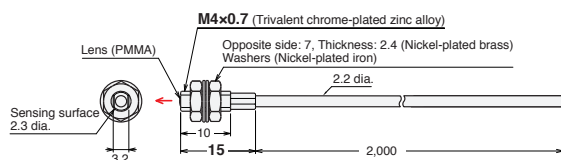

- Reference Information for Model Selection -

Features of the Right-angle Type

- Cable is less prone to snagging.
- Cable runs along the mounting surface for less space compared with Top-view Fiber Units.
- The nut is attached to the Fiber Unit to reduce installation work.

What Is "Flexible" Fiber?

The flexible fiber has a small bending radius for easy routing without easily breaking. It is easy to use because the cable can be bent without significantly reducing light intensity.



Cores
Cladding

Build-in Lens

What Are Fiber Units with Build-in Lenses?

These Fiber Units have built-in lenses. They feature high-power beams and narrow field of views (an aperture angle of 15°). You don't have to worry about the lens falling off and getting lost.

And

Long-distance Sensing Applications

A separate Lens Unit can be attached to extend the sensing distance.
→ 26 Page

Breaking Due to Snagging or Shock

The Fiber Unit can be protected from breaking with stainless steel spiral tube.
→ 40 Page (Excluding the E32-T11N 2M.)

Fiber Sensor
Features

Selection
Guide

Fiber Units

Threaded
Cylindrical

Standard Installation

Flat

Saving Space

Sleeved

Small Spot

High Power

Beam Improvements

Narrow view

BGS

Retro-reflective

Transparent Objects

Limited-reflective

Chemical-resistant,
Oil-resistant

Environmental Immunity

Bending

Heat-resistant

Area Detection

Liquid-level

Applications

Vacuum

FPD,
Semi,
Solar

Installation
Information

Fiber Amplifiers,
Communications
Unit, and
Accessories

Technical
Guide and
Precautions

Model Index

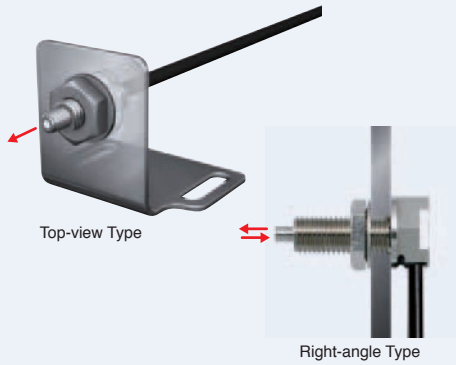

- Standard configuration. These Fiber Units are mounted into a hole drilled in a bracket and secured with nuts.
- The Right-angle Model prevents snagging on the cable because the cable runs along the mounting surface.

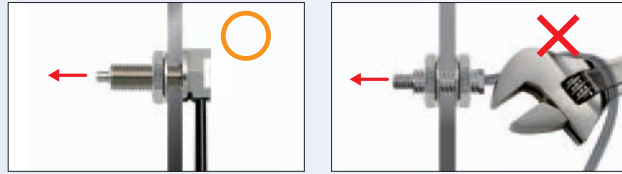

Hex-shaped Fiber Units have been added to the series. (They have a right-angle shape like that of the E32-C31N shown below.)

→ 96 Page

Specifications

Reflective Fiber Units

Sensing direction (Aperture angle)	Size	Appearance (mm)	Bending radius of cable	Sensing distance (mm)						Optical axis diameter (minimum sensing object)	Models	09 Page Dimensions No.
				E3X-HD			E3NX-FA NEW					
				GIGA	HS	Other modes	GIGA	HS	Other modes			
Right-angle (Approx. 60°)	M3		Flexible, R4	110 46	ST : 50 SHS: 14	160 69	ST : 75 SHS: 14	(5 μm dia./ 2 μm dia.)	E32-C31N 2M	09-A		
	M6			780 320	ST : 350 SHS: 100	1,170 480	ST : 520 SHS: 100		E32-C11N 2M	09-B		
Top-view (Approx. 60°)	M3		Flexible, R1	140 40	ST : 60 SHS: 16	210 60	ST : 90 SHS: 16		E32-D21R 2M	09-C		
			R25	330 100	ST : 150 SHS: 44	490 150	ST : 220 SHS: 44		E32-C31 2M	09-D		
			R10	140 40	ST : 60 SHS: 16	210 60	ST : 90 SHS: 16		E32-C31M 1M	09-E		
	M4		Flexible, R1	140 40	ST : 60 SHS: 16	210 60	ST : 90 SHS: 16		E32-D211R 2M	09-F		
	M6		Flexible, R1	840 240	ST : 350 SHS: 100	1,260 360	ST : 520 SHS: 100		E32-D11R 2M	09-G		
			R25	1,400 400	ST : 600 SHS: 180	2,100 600	ST : 900 SHS: 180		E32-CC200 2M	09-H		
Top-view (Approx. 15°)	M6		R25	860 250	ST : 360 SHS: 110	1,290 370	ST : 540 SHS: 110		E32-LD11 2M NEW	09-I		
			Flexible, R1	840 240	ST : 350 SHS: 100	1,260 360	ST : 520 SHS: 100		E32-LD11R 2M NEW			

Note 1. The following mode names and response times apply to the modes given in the Sensing distance column.
 [E3X-HD] GIGA: Giga-power mode (16 ms), HS: High-speed mode (250 μs), ST: Standard mode (1 ms), and SHS: Super-high-speed mode (NPN output: 50 μs, PNP output: 55 μs)
 [E3NX-FA] GIGA: Giga-power mode (16 ms), HS: High-speed mode (250 μs), ST: Standard mode (1 ms), and SHS: Super-high-speed mode (30 μs)
2. The values for the minimum sensing object are reference values that indicate values obtained in standard mode with the sensing distance and sensitivity set to the optimum values. The first value is for the E3X-HD and the second value is for the E3NX-FA.
3. The sensing distances for Reflective Fiber Units are for white paper. (The sensing distance for the E32-LD11 2M / E32-LD11R 2M are for glossy white paper.)

Dimensions

Installation Information → 58, 59 Page

Reflective Fiber Units

09-A E32-C31N 2M (Free Cutting)

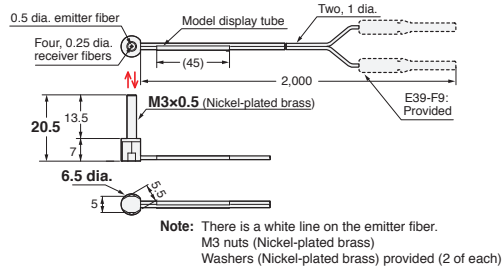

09-B E32-C11N 2M (Free Cutting)

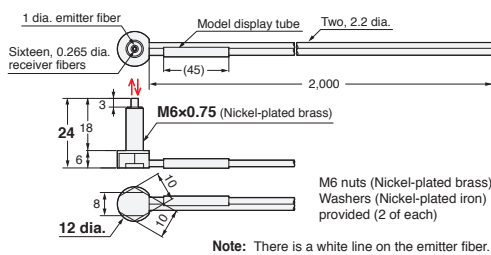

09-C E32-D21R 2M (Free Cutting)

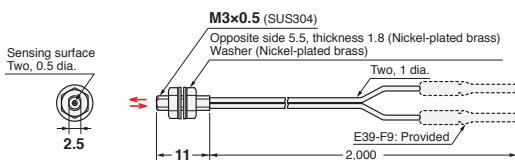

09-D E32-C31 2M (Free Cutting)

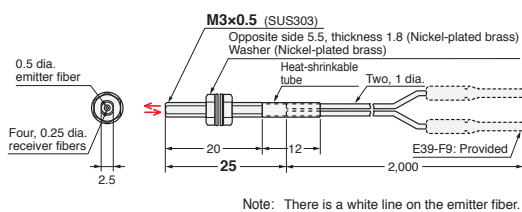

09-E E32-C31M 1M (Free Cutting)

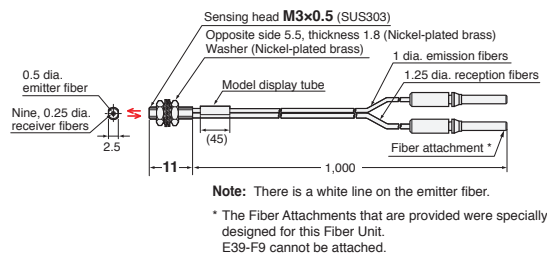

09-F E32-D211R 2M (Free Cutting)

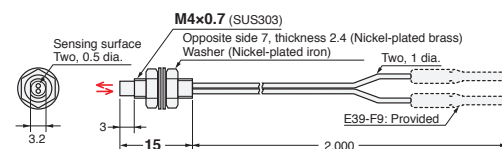

09-G E32-D11R 2M (Free Cutting)

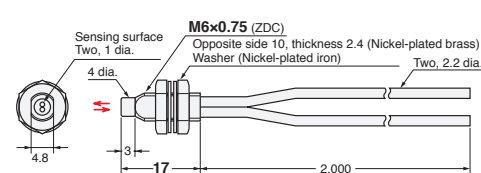

09-H E32-CC200 2M (Free Cutting)

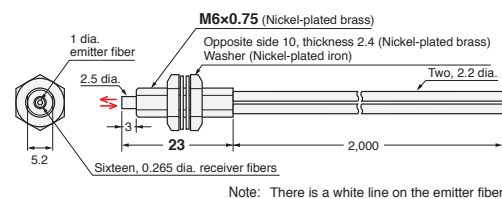

09-I E32-LD11 2M (Free Cutting)

E32-LD11R 2M (Free Cutting)

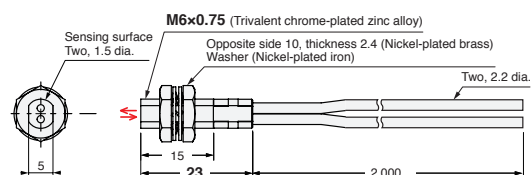

- Reference Information for Model Selection -

Features of Coaxial Reflective Type

These Fiber Units offer better detection of small objects at close distances (of 2 mm or less) than Standard Reflective Fiber Units. They also detect glossy surfaces more reliably than Standard Reflective Fiber Units, even if the surface is tilted. The receiver fibers are arranged around the emitter fiber as shown below.

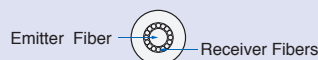

Features of the Right-angle Type

- Cable is less prone to snagging.
- Cable runs along the mounting surface for less space compared with Top-view Fiber Units.
- The nut is attached to the Fiber Unit to reduce installation work.

What Is "Flexible" Fiber?

The flexible fiber has a small bending radius for easy routing without easily breaking. It is easy to use because the cable can be bent without significantly reducing light intensity.

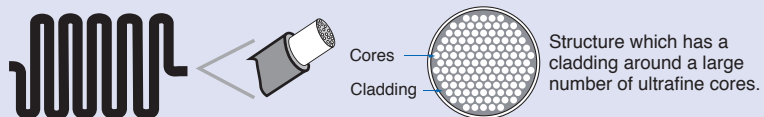

Build-in Lenses

What Are Fiber Units with Build-in Lenses?

These Fiber Units have built-in lenses. They feature high-power beams and narrow field of views (an aperture angle of 15°). You don't have to worry about the lens falling off and getting lost.

And

Breaking Due to Snagging or Shock

The Fiber Unit can be protected from breaking with stainless steel spiral tube.

→ 42 Page

Fiber Sensor
Features

Selection
Guide

Fiber Units

Threaded

Cylindrical

Flat

Sleeved

Small Spot

High Power

Narrow
view

BGS

Retro-
reflective

Limited-
reflective

Chemical-
resistant,
Oil-resistant

Bending

Heat-
resistant

Area
Detection

Liquid-level

Vacuum

FPD,
Semi,
Solar

Installation
Information

Fiber Amplifiers,
Communications
Unit, and
Accessories

Technical
Guide and
Precautions

Model Index

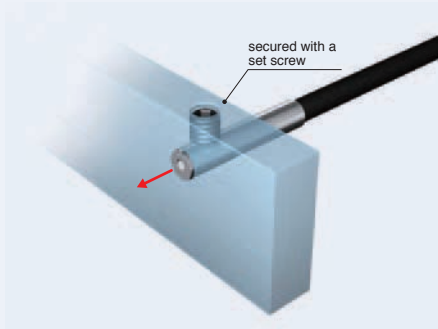

- Inserted where space is limited. (Secured using a set screw.)
- Ultraminate space-saving by micro-fiber head. (1 dia. × 10 mm)

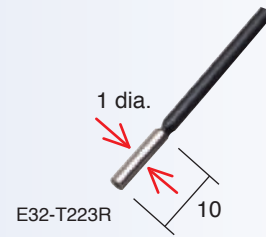

- Side-view models can be mounted where there is limited depth.

Specifications

Through-beam Fiber Units

Size	Sensing direction	Appearance (mm)	Bending radius of cable	Sensing distance (mm)						Optical axis diameter (minimum sensing object)	Models	11 Page Dimensions No.
				E3X-HD			E3NX-FA <i>NEW</i>					
				GIGA	HS	Other modes	GIGA	HS	Other modes			
1 dia.	Top-view		Flexible, R1	450	ST : 250	670	ST : 370	0.5 dia. (5 μm dia./ 2 μm dia.)	E32-T223R 2M	11-A		
				150	SHS: 60	220	SHS: 60					
1.5 dia.	Top-view		Bendresistant, R4	680	ST : 400	1,020	ST : 600	1 dia. (5 μm dia./ 2 μm dia.)	E32-T22B 2M	11-B		
				220	SHS: 90	330	SHS: 90					
3 dia.	Side-view		Flexible, R1	2,000	ST : 1,000	3,000	ST : 1,500	1 dia. (5 μm dia./ 2 μm dia.)	E32-T12R 2M	11-C		
				700	SHS: 280	1,050	SHS: 280					
				750	ST : 450	1,120	ST : 670		E32-T14LR 2M	11-D		
				260	SHS: 100	390	SHS: 100					

Note 1. The following mode names and response times apply to the modes given in the Sensing distance column.
 [E3X-HD] GIGA: Giga-power mode (16 ms), HS: High-speed mode (250 μs), ST: Standard mode (1 ms), and SHS: Super-high-speed mode (NPN output: 50 μs, PNP output: 55 μs)
 [E3NX-FA] GIGA: Giga-power mode (16 ms), HS: High-speed mode (250 μs), ST: Standard mode (1 ms), and SHS: Super-high-speed mode (30 μs)
2. The values for the minimum sensing object are reference values that indicate values obtained in standard mode with the sensing distance and sensitivity set to the optimum values. The first value is for the E3X-HD and the second value is for the E3NX-FA.

Dimensions

Installation Information → 60 Page

Through-beam Fiber Units (Set of 2)

11-A E32-T223R 2M (Free Cutting)

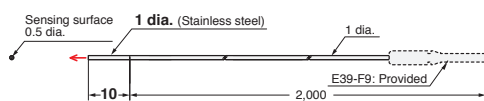

11-B E32-T22B 2M (Free Cutting)

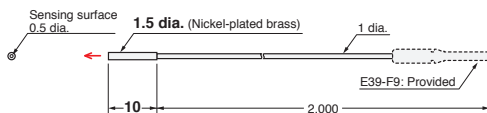

11-C E32-T12R 2M (Free Cutting)

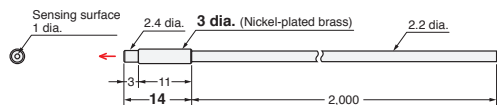

11-D E32-T14LR 2M (Free Cutting)

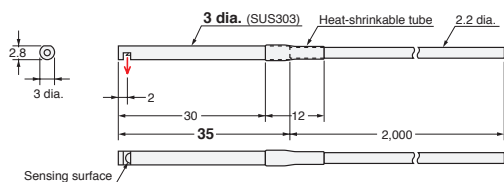

- Reference Information for Model Selection -

Recommended Mounting Hole Dimensions

The recommended mounting-hole dimensions for Cylindrical Fiber Units are given below.

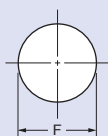

(Unit: mm)

Outer diameter of Fiber Unit	1 dia.	1.5 dia.	3 dia.
Dimension F	1.2 ^{+0.5} ₀ dia.	1.7 ^{+0.5} ₀ dia.	3.2 ^{+0.5} ₀ dia.

Fiber Sensor
Features

Selection
Guide

Fiber Units

Threaded

Cylindrical

Standard Installation

Flat

Sleeved

Saving Space

Small Spot

High Power

Beam Improvements

Narrow view

BGS

Retro-reflective

Limited-reflective

Transparent Objects

Chemical-resistant,
Oil-resistant

Bending

Heat-resistant

Environmental Immunity

Area Detection

Liquid-level

Applications

Vacuum

FPD,
Semi,
Solar

Installation
Information

Fiber Amplifiers,
Communications
Unit, and
Accessories

Technical
Guide and
Precautions

Model Index

- Inserted where space is limited.
(Secured using a set screw.)

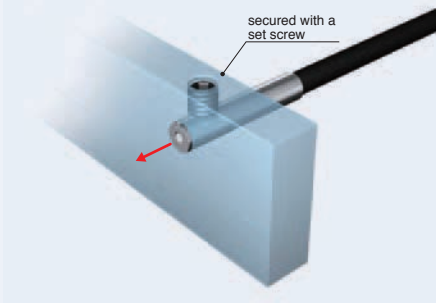

Specifications

Reflective Fiber Units

Size	Sensing direction	Appearance (mm)	Bending radius of cable	Sensing distance (mm)						Optical axis diameter (minimum sensing object)	Models	13 Page Dimensions No.				
				E3X-HD			E3NX-FA <i>NEW</i>									
				GIGA	HS	Other modes	GIGA	HS	Other modes							
1.5 dia.	Top-view		Bend-resistant, R4	140	ST : 60	210	ST : 90	(5 μm dia./ 2 μm dia.)	E32-D22B 2M	13-A						
		40	SHS: 16	60	SHS: 16											
1.5 dia. + 0.5 dia.	Top-view		R25	28	ST : 12	42	ST : 18				(5 μm dia./ 2 μm dia.)	E32-D43M 1M	13-B			
		8	SHS: 4	12	SHS: 4											
3 dia.	Top-view		Flexible, R1	140	ST : 60	210	ST : 90							(5 μm dia./ 2 μm dia.)	E32-D22R 2M	13-C
		40	SHS: 16	60	SHS: 16											
			Bend-resistant, R4	300	ST : 140	450	ST : 210	(5 μm dia./ 2 μm dia.)	E32-D221B 2M	13-D						
		90	SHS: 40	130	SHS: 40											
	R25	700	ST : 300	1,050	ST : 450	(5 μm dia./ 2 μm dia.)	E32-D32L 2M				13-E					
200		SHS: 90	300	SHS: 90												
3 dia. + 0.8 dia.	Top-view		R25	70	ST : 30							100	ST : 45	(5 μm dia./ 2 μm dia.)	E32-D33 2M	13-F
		20		SHS: 8	30							SHS: 8				

Note 1. The following mode names and response times apply to the modes given in the Sensing distance column.
 [E3X-HD] GIGA: Giga-power mode (16 ms), HS: High-speed mode (250 μs), ST: Standard mode (1 ms), and SHS: Super-high-speed mode (NPN output: 50 μs, PNP output: 55 μs)
 [E3NX-FA] GIGA: Giga-power mode (16 ms), HS: High-speed mode (250 μs), ST: Standard mode (1 ms), and SHS: Super-high-speed mode (30 μs)
2. The values for the minimum sensing object are reference values that indicate values obtained in standard mode with the sensing distance and sensitivity set to the optimum values.
 The first value is for the E3X-HD and the second value is for the E3NX-FA.
3. The sensing distances for Reflective Fiber Units are for white paper.

Dimensions

Installation Information → 58, 59 Page

Reflective Fiber Units

13-A E32-D22B 2M (No Cutting)

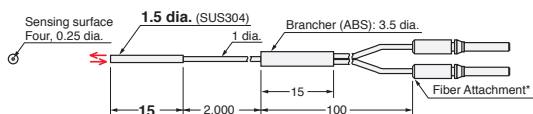

* Attached with adhesive and cannot be removed.

Enlarged View of Sensing Surface

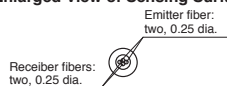

13-B E32-D43M 1M (No Cutting)

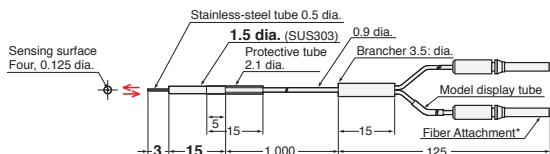

* Attached with adhesive and cannot be removed.

13-C E32-D22R 2M (Free Cutting)

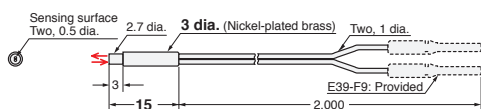

13-D E32-D221B 2M (Free Cutting)

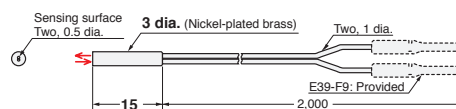

13-E E32-D32L 2M (Free Cutting)

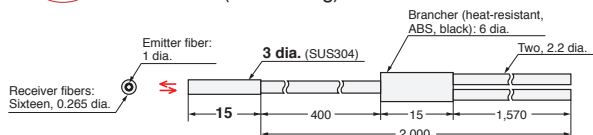

Note: There is a yellow dotted line on the Emitter fiber.

13-F E32-D33 2M (Free Cutting)

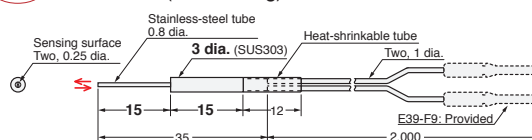

- Reference Information for Model Selection -

Features of Coaxial Reflective Type

These Fiber Units offer better detection of small objects at close distances (of 2 mm or less) than Standard Reflective Fiber Units. They also detect glossy surfaces more reliably than Standard Reflective Fiber Units, even if the surface is tilted. The receiver fibers are arranged around the emitter fiber as shown below.



Recommended Mounting Hole Dimensions

The recommended mounting-hole dimensions for Cylindrical Fiber Units are given below.

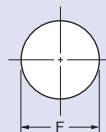

(Unit: mm)

Outer diameter of Fiber Unit	1.5 dia.	3 dia.
Dimension F	1.7 ^{+0.5} ₀ dia.	3.2 ^{+0.5} ₀ dia.

Fiber Sensor Features

Selection Guide

Fiber Units

Threaded

Cylindrical

Flat

Sleeved

Small Spot

High Power

Narrow view

BGS

Retro-reflective

Limited-reflective

Chemical-resistant, Oil-resistant

Bending

Heat-resistant

Area Detection

Liquid-level

Vacuum

FPD, Semi, Solar

Installation Information

Fiber Amplifiers, Communications Unit, and Accessories

Technical Guide and Precautions

Model Index

- Threaded
- Cylindrical

- Flat
- Sleeved

- Small Spot
- High Power
- Narrow view
- BGS

- Retro-reflective
- Limited-reflective

- Chemical-resistant, Oil-resistant
- Bending
- Heat-resistant

- Area Detection
- Liquid-level
- Vacuum
- FPD, Semi, Solar

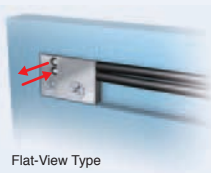

Flat-View Type

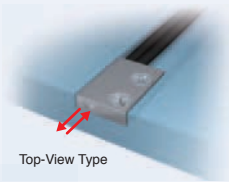

Top-View Type



Side-View Type

- Thin profile for mounting in limited spaces.
- Mounts directly without using special mounting brackets.

Specifications

Through-beam Fiber Units

Sensing direction	Appearance (mm)	Bending radius of cable	Sensing distance (mm)				Optical axis diameter (minimum sensing object)	Models	15 Page Dimensions No.
			E3X-HD		E3NX-FA <i>NEW</i>				
			GIGA	HS	GIGA	HS			
Top-view		Flexible, R1	2,000	ST : 1,000	3,000	ST : 1,500	1 dia. (5 μm dia./ 2 μm dia.)	E32-T15XR 2M	15-A
Side-view			700	SHS: 280	1,050	SHS: 280			
Flat-view			750	ST : 450	1,120	ST : 670			
			260	SHS: 100	390	SHS: 100		E32-T15ZR 2M	15-C

Reflective Fiber Units

Sensing direction	Appearance (mm)	Bending radius of cable	Sensing distance (mm)				Optical axis diameter (minimum sensing object)	Models	15 Page Dimensions No.
			E3X-HD		E3NX-FA <i>NEW</i>				
			GIGA	HS	GIGA	HS			
Top-view		Flexible, R1	840	ST : 350	1,260	ST : 520	5 μm dia./ 2 μm dia.)	E32-D15XR 2M	15-D
Side-view			240	SHS: 100	360	SHS: 100			
Flat-view			200	ST : 100	300	ST : 150			
			52	SHS: 24	78	SHS: 24		E32-D15ZR 2M	15-F

- Note 1.** The following mode names and response times apply to the modes given in the Sensing distance column.
 [E3X-HD] GIGA: Giga-power mode (16 ms), HS: High-speed mode (250 μs), ST: Standard mode (1 ms), and SHS: Super-high-speed mode (NPN output: 50 μs, PNP output: 55 μs)
 [E3NX-FA] GIGA: Giga-power mode (16 ms), HS: High-speed mode (250 μs), ST: Standard mode (1 ms), and SHS: Super-high-speed mode (30 μs)
- 2.** The values for the minimum sensing object are reference values that indicate values obtained in standard mode with the sensing distance and sensitivity set to the optimum values.
 The first value is for the E3X-HD and the second value is for the E3NX-FA.
- 3.** The sensing distances for Reflective Fiber Units are for white paper.

Dimensions

Installation Information → 60 Page

Through-beam Fiber Units (Set of 2)

15-A E32-T15XR 2M (Free Cutting)

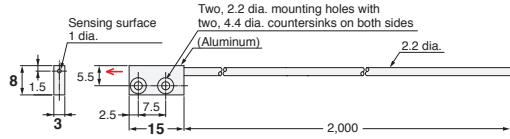

Note: 1. Set of two symmetrically shaped Fiber Units.
2. Four, M2 x 8 stainless steel countersunk mounting screws are provided.

15-B E32-T15YR 2M (Free Cutting)

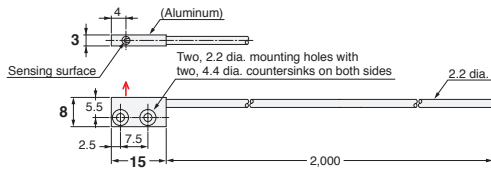

Note: 1. Set of two symmetrically shaped Fiber Units.
2. Four, M2 x 8 stainless steel countersunk mounting screws are provided.

15-C E32-T15ZR 2M (Free Cutting)

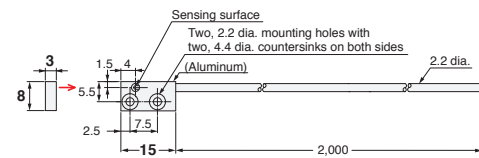

Note: 1. Set of two symmetrically shaped Fiber Units.
2. Four, M2 x 8 stainless steel countersunk mounting screws are provided.

Installation Information → 58 Page

Reflective Fiber Units

15-D E32-D15XR 2M (Free Cutting)

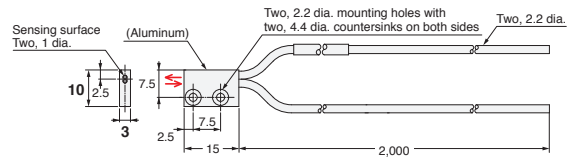

Note: Two, M2 x 8 stainless steel countersunk mounting screws are provided.

15-E E32-D15YR 2M (Free Cutting)

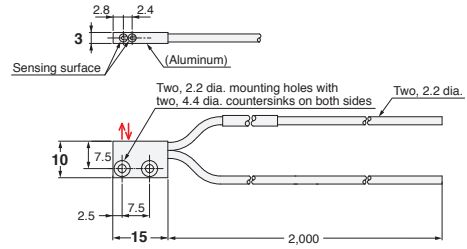

Note: Two, M2 x 8 stainless steel countersunk mounting screws are provided.

15-F E32-D15ZR 2M (Free Cutting)

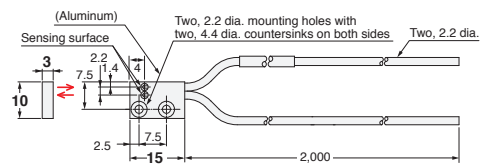

Note: Two, M2 x 8 stainless steel countersunk mounting screws are provided.

Fiber Sensor Features

Selection Guide

Fiber Units

Threaded	Standard Installation
Cylindrical	
Flat	Saving Space
Sleeved	
Small Spot	Beam Improvements
High Power	
Narrow view	
BGS	Transparent Objects
Retro-reflective	
Limited-reflective	
Chemical-resistant, Oil-resistant	Environmental Immunity
Bending	
Heat-resistant	
Area Detection	Applications
Liquid-level	
Vacuum	
FPD, Semi, Solar	

Installation Information

Fiber Amplifiers, Communications Unit, and Accessories

Technical Guide and Precautions

Model Index

- Threaded
- Cylindrical

- Flat
- Sleeved**

- Small Spot
- High Power
- Narrow view
- BGS

- Retro-reflective
- Limited-reflective

- Chemical-resistant, Oil-resistant
- Bending
- Heat-resistant

- Area Detection
- Liquid-level
- Vacuum
- FPD, Semi, Solar

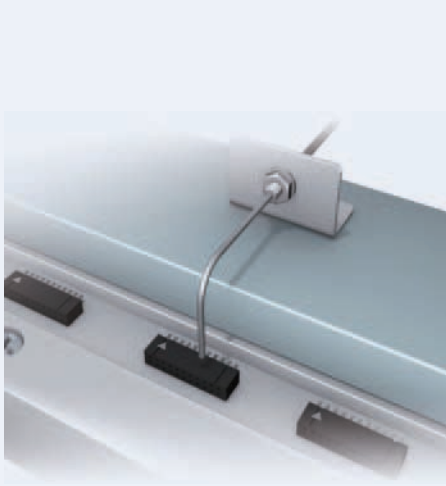

- Sleeve Fiber Units allow detection away from the point of installation for stable close-range detection of small objects.
- The shape of sleeve can be changed freely. (Refer to the sleeve bending specifications in the Appearance column of the specifications table.)

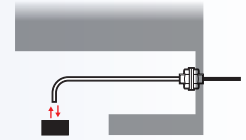

Specifications

Through-beam Fiber Units

Sensing direction	Appearance (mm)	Bending radius of cable	Sensing distance (mm)						Optical axis diameter (minimum sensing object)	Models	17 Page Dimensions No.
			E3X-HD			E3NX-FA <i>NEW</i>					
			GIGA	HS	Other modes	GIGA	HS	Other modes			
Side-view	The sleeve cannot be bent.	Flexible, R1	170	ST : 100	250	ST : 150	0.5 dia. (5 μm dia./ 2 μm dia.)	E32-T24R 2M	17-A		
	50		SHS: 20	75	SHS: 20						
Side-view	The sleeve cannot be bent.	R10	450	ST : 250	670	ST : 370	0.25 dia. (5 μm dia./ 2 μm dia.)	E32-T24E 2M	17-B		
	150		SHS: 60	220	SHS: 60						
Top-view	The sleeve cannot be bent.	R10	150	ST : 90	220	ST : 130	0.25 dia. (5 μm dia./ 2 μm dia.)	E32-T33 1M	17-C		
	50		SHS: 20	75	SHS: 20						
Top-view	The sleeve cannot be bent.	Flexible, R1	510	ST : 300	760	ST : 450	0.5 dia. (5 μm dia./ 2 μm dia.)	E32-T21-S1 2M <i>NEW</i>	17-D		
	170		SHS: 68	250	SHS: 68						
Top-view	Sleeve bending radius: 5 mm.	Flexible, R1	2,000	ST : 1,000	3,000	ST : 1,500	1 dia. (5 μm dia./ 2 μm dia.)	E32-TC200BR 2M	17-E		
	700		SHS: 280	1,050	SHS: 280						

Note 1. The following mode names and response times apply to the modes given in the Sensing distance column.
 [E3X-HD] GIGA: Giga-power mode (16 ms), HS: High-speed mode (250 μs), ST: Standard mode (1 ms), and SHS: Super-high-speed mode (NPN output: 50 μs, PNP output: 55 μs)
 [E3NX-FA] GIGA: Giga-power mode (16 ms), HS: High-speed mode (250 μs), ST: Standard mode (1 ms), and SHS: Super-high-speed mode (30 μs)

2. The values for the minimum sensing object are reference values that indicate values obtained in standard mode with the sensing distance and sensitivity set to the optimum values. The first value is for the E3X-HD and the second value is for the E3NX-FA.

Dimensions

Installation Information → 60, 61 Page

Through-beam Fiber Units (Set of 2)

17-A E32-T24R 2M (Free Cutting)

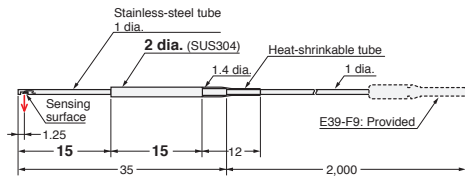

17-B E32-T24E 2M (Free Cutting)

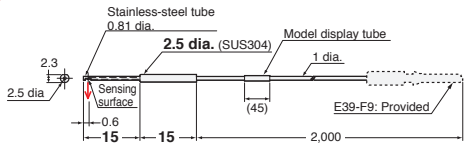

17-C E32-T33 1M (Free Cutting)

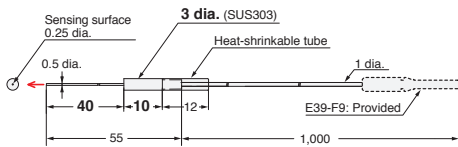

17-D E32-T21-S1 2M (Free Cutting)

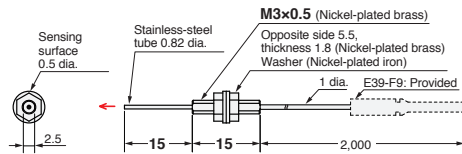

17-E E32-TC200BR 2M (Free Cutting)

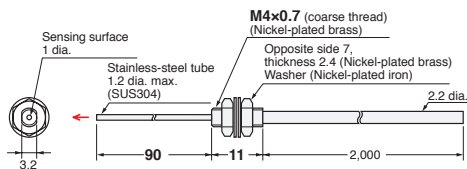

- Reference Information for Model Selection -

And

In case of bending sleeve

The E32-TC200BR has a bendable sleeve.
Use the Sleeve Bender to bend them.

Sleeve Bender (sold separately)

Appearance	Applicable Fiber Units	Model
 Uses for the bending of the sleeve.	E32-TC200BR	E39-F11

Fiber Sensor Features

Selection Guide

Fiber Units

Threaded

Cylindrical

Flat

Sleeved

Small Spot

High Power

Narrow view

BGS

Retro-reflective

Limited-reflective

Chemical-resistant, Oil-resistant

Bending

Heat-resistant

Area Detection

Liquid-level

Vacuum

FPD, Semi, Solar

Installation Information

Fiber Amplifiers, Communications Unit, and Accessories

Technical Guide and Precautions

Model Index

- Threaded
- Cylindrical

- Flat
- Sleeved**

- Small Spot
- High Power
- Narrow view
- BGS

- Retro-reflective
- Limited-reflective

- Chemical-resistant, Oil-resistant
- Bending
- Heat-resistant

- Area Detection
- Liquid-level
- Vacuum
- FPD, Semi, Solar

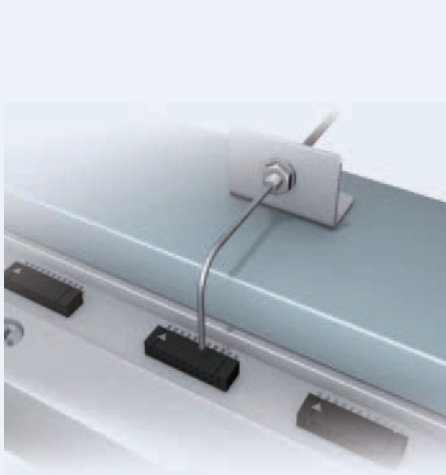

- Sleeve Fiber Units allow detection away from the point of installation for stable close-range detection of small objects.
- The shape of sleeve can be changed freely. (Refer to the sleeve bending specifications in the Appearance column of the specifications table.)

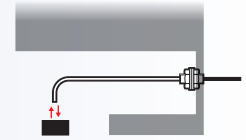

Specifications

Reflective Fiber Units

Sensing direction	Appearance (mm)	Bending radius of cable	Sensing distance (mm)						Optical axis diameter (minimum sensing object)	Models	19 Page Dimensions No.
			E3X-HD			E3NX-FA NEW					
			GIGA	HS	Other modes	GIGA	HS	Other modes			
Side-view	The sleeve cannot be bent.	Flexible, R1	70		ST : 30	100		ST : 45	5 μm dia./ 2 μm dia.)	E32-D24R 2M	19-A
	Sleeve bending radius: 25 mm	R25	120		ST : 53	180		ST : 79		E32-D24-S2 2M NEW	19-B
	The sleeve cannot be bent.	R4	28		ST : 12	42		ST : 18		E32-D43M 1M	19-C
	The sleeve cannot be bent.		8		SHS: 4	12		SHS: 4		E32-D331 2M	19-D
Top-view	The sleeve cannot be bent.	R25	70		ST : 30	100		ST : 45	E32-D33 2M	19-E	
	The sleeve cannot be bent.	R4	14		ST : 6	21		ST : 9	E32-D32-S1 0.5M NEW	19-F	
	The sleeve cannot be bent.		4		SHS: 2	6		SHS: 2	E32-D31-S1 0.5M NEW	19-G	
	The sleeve cannot be bent.	Flexible, R1	63		ST : 27	94		ST : 40	E32-DC200F4R 2M	19-H	
	The sleeve cannot be bent.		18		SHS: 7	27		SHS: 7	E32-D22-S1 2M NEW	19-I	
	Sleeve bending radius: 5 mm	R10	140		ST : 60	210		ST : 90	E32-D21-S3 2M NEW	19-J	
	The sleeve cannot be bent.		40		SHS: 16	60		SHS: 16	E32-DC200BR 2M	19-K	
	The sleeve cannot be bent.	Flexible, R1	250		ST : 110	370		ST : 160	E32-D25-S3 2M NEW	19-L	
	Sleeve bending radius: 10 mm		72		SHS: 30	100		SHS: 30			
	The sleeve cannot be bent.	R10	840		ST : 350	1,260		ST : 520			
Sleeve bending radius: 10 mm	240			SHS: 100	360		SHS: 100				
			250		ST : 110	370		ST : 160			
			72		SHS: 30	100		SHS: 30			

Note 1. The following mode names and response times apply to the modes given in the Sensing distance column.
 [E3X-HD] GIGA: Giga-power mode (16 ms), HS: High-speed mode (250 μs), ST: Standard mode (1 ms), and SHS: Super-high-speed mode (NPN output: 50 μs, PNP output: 55 μs)
 [E3NX-FA] GIGA: Giga-power mode (16 ms), HS: High-speed mode (250 μs), ST: Standard mode (1 ms), and SHS: Super-high-speed mode (30 μs)
2. The values for the minimum sensing object are reference values that indicate values obtained in standard mode with the sensing distance and sensitivity set to the optimum values. The first value is for the E3X-HD and the second value is for the E3NX-FA.
3. The sensing distances for Reflective Fiber Units are for white paper.

Dimensions

Installation Information → 58, 59 Page

Reflective Fiber Units

19-A E32-D24R 2M (Free Cutting)

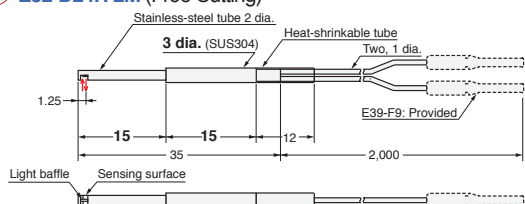

19-B E32-D24-S2 2M (Free Cutting)

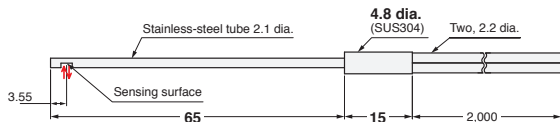

19-C E32-D43M 1M (No Cutting)

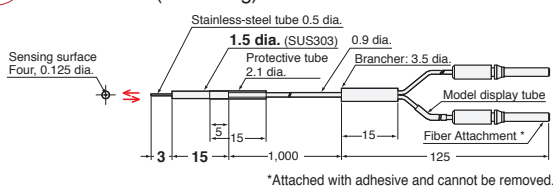

*Attached with adhesive and cannot be removed.

19-D E32-D331 2M (No Cutting)

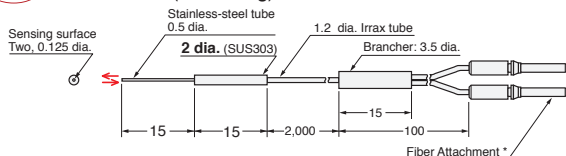

*Attached with adhesive and cannot be removed.

19-E E32-D33 2M (Free Cutting)

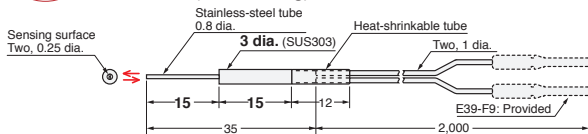

19-F E32-D32-S1 0.5M (No Cutting)

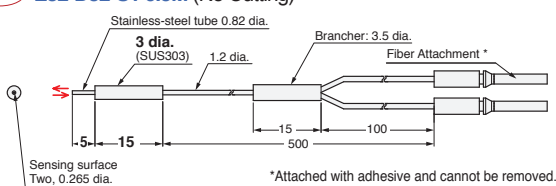

*Attached with adhesive and cannot be removed.

19-G E32-D31-S1 0.5M (No Cutting)

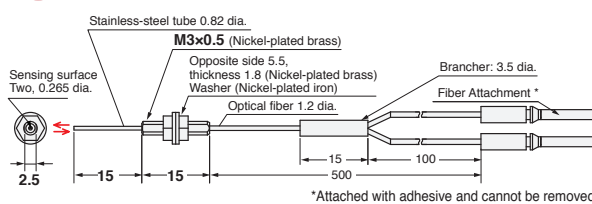

*Attached with adhesive and cannot be removed.

19-H E32-DC200F4R 2M (Free Cutting)

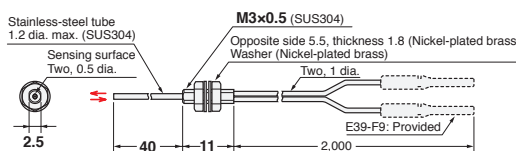

19-I E32-D22-S1 2M (Free Cutting)

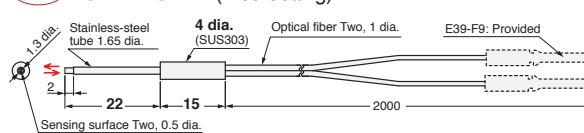

19-J E32-D21-S3 2M (Free Cutting)

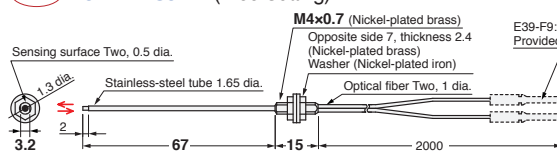

19-K E32-DC200BR 2M (Free Cutting)

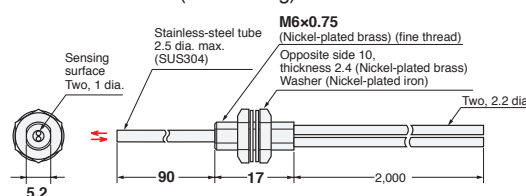

19-L E32-D25-S3 2M (Free Cutting)

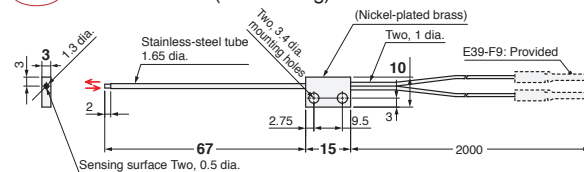

- Reference Information for Model Selection -

And

In case of bending sleeve

The E32-DC200F4R, E32-D21-S3 and E32-D25-S3 have bendable sleeves. Use the Sleeve Bender to bend them.

Sleeve Bender (sold separately)

Appearance	Applicable Fiber Units	Model
 Uses for the bending of the sleeve.	E32-DC200F4R E32-D21-S3 E32-D25-S3	E39-F11

Fiber Sensor Features

Selection Guide

Fiber Units

Threaded
Cylindrical

Flat

Sleeved

Small Spot

High Power

Narrow view

BGS

Retro-reflective

Limited-reflective

Chemical-resistant, Oil-resistant

Bending

Heat-resistant

Area Detection

Liquid-level

Vacuum

FPD, Semi, Solar

Installation Information

Fiber Amplifiers, Communications Unit, and Accessories

Technical Guide and Precautions

Model Index

- Threaded
- Cylindrical

- Flat
- Sleeved

- Small Spot
- High Power
- Narrow view
- BGS

- Retro-reflective
- Limited-reflective

- Chemical-resistant, Oil-resistant
- Bending
- Heat-resistant

- Area Detection
- Liquid-level
- Vacuum
- FPD, Semi, Solar



- Small-spot is ideal for detecting minute objects. Select the Fiber Unit that is best suited for the workpiece size and installation distance. (Refer to Reference Information for Model Selection)
- Available with a variable-spot Lens Unit to change the spot diameter without replacing the fiber. The spot diameter can be adjusted according to the size of the workpiece by changing the withdrew length and sensing distance. Refer to the following graph, which shows the relation between the withdrew length, focal distance, and spot diameter.

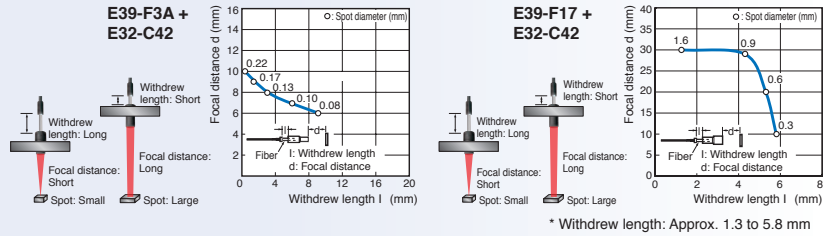

Specifications

Reflective Fiber Units

Variable-spot types

Lens Units + Fiber Unit

Type	Spot diameter	Center distance (mm)	Lens Units	Lens Units + Fiber Units	Fiber Unit		21 Page Dimensions No.
			Models	Appearance (mm)	Bending radius of cable	Model	
Variable spot	0.1 to 0.6 dia.	6 to 15	E39-F3A		R25	E32-C42 1M	21-A
	0.3 to 1.6 dia.	10 to 30	E39-F17				21-B

Parallel-light-spot types

Lens Units + Fiber Unit

Type	Spot diameter	Center distance (mm)	Lens Units	Lens Units + Fiber Units	Fiber Unit		21 Page Dimensions No.
			Model	Appearance (mm)	Bending radius of cable	Models	
Parallel light	4 dia.	0 to 20	E39-F3C		R25	E32-C31 2M	21-C
							Flexible, R2

Small-spot types

Integrated Lens

Type	Spot diameter	Center distance (mm)	Appearance (mm)	Bending radius of cable	Models	21 Page Dimensions No.
Short-distance, Small-spot	0.1 dia.	5		R25	E32-C42S 1M	21-E
Long-distance, Small-spot	6 dia.	50			E32-L15 2M	21-F

* The spot diameter and the center distance are the same when using with E3X-HD series or E3NX-FA series.

Dimensions

Installation Information → 58, 59 and 61 Page

Reflective Fiber Units

21-A E32-C42 1M (No Cutting) + E39-F3A

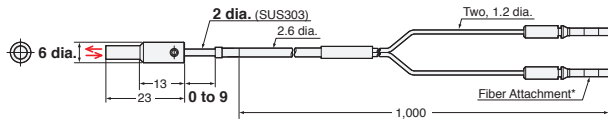

* Attached with adhesive and cannot be removed.
Note: There is a white tube on the emitter fiber.

E39-F3A

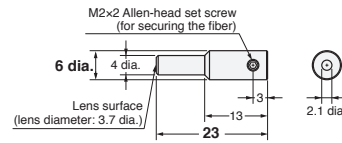

Material: Aluminum for body and optical glass for lens.
Note: This is the Lens Unit for the E32-C42.

21-B E32-C42 1M (No Cutting) + E39-F17

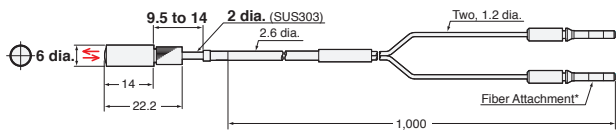

* Attached with adhesive and cannot be removed.
Note: There is a white tube on the emitter fiber.

E39-F17

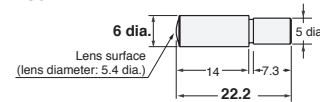

Material: Aluminum for body and optical glass for lens.

21-C E32-C31 2M (Free Cutting) + E39-F3C

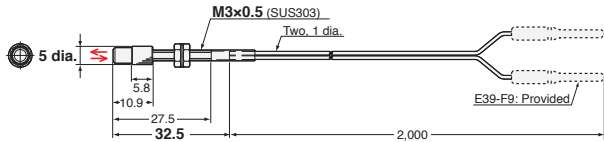

Note: There is a white line on the emitter fiber.

E39-F3C

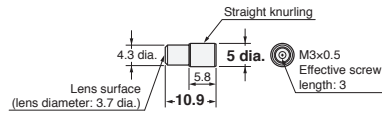

Material: Aluminum for body and optical glass for lens.
Note: This is the Lens Unit for the E32-C31 and E32-C31N.

21-D E32-C21N 2M (Free Cutting) + E39-F3C

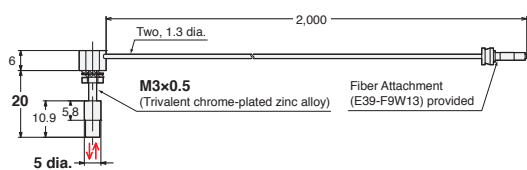

Note: There is a white line on the emitter fiber.

21-E E32-C42S 1M (No Cutting)

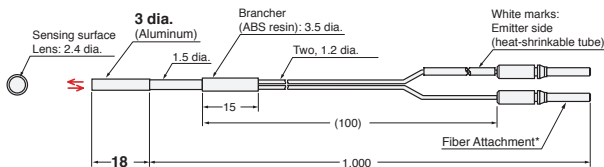

* Attached with adhesive and cannot be removed.
Note: There is a white tube on the emitter fiber.

21-F E32-L15 2M (Free Cutting)

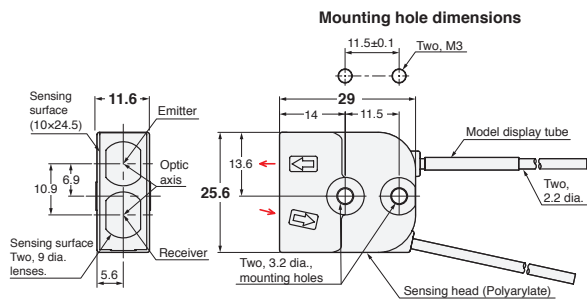

Note: There is a white tube on the emitter fiber.

- Reference Information for Model Selection -

Model Selection Tips

- Select the best model by following these steps.
 - Select the model based on the spot diameter suitable for the workpiece size.
 - * The Variable-spot Type is useful if there are different sensing object sizes.
 - Select the model based on the allowable installation distance and center distance.

<Map of Spot Diameters and Center Distances>

(Unit: mm)

Spot diameter	0.1 dia.	0.1 dia.	0.2 dia.	0.5 dia.	0.5 dia.	3 dia.	4 dia.	6 dia.
Center distance	5	7	17	7	17	50	0 to 20	50
Optical axis diameter	2.4	3.7	4.8	3.7	4.8	9.4	3.7	10
Models	E32-C42S	E39-F3A-5 + E32-C41	E39-F3B + E32-C41	E39-F3A-5 + E32-C31 + E32-C21N	E39-F3B + E32-C31 + E32-C21N	E39-F18 + E32-CC200 + E32-C11N	E39-F3C + E32-C31 + E32-C21N	E32-L15

* Refer to page 22 for details.

Fiber Sensor Features

Selection Guide

Fiber Units

Threaded

Cylindrical

Flat

Sleeved

Small Spot

High Power

Narrow view

BGS

Retro-reflective

Limited-reflective

Chemical-resistant, Oil-resistant

Bending

Heat-resistant

Area Detection

Liquid-level

Vacuum

FPD, Semi, Solar

Installation Information

Fiber Amplifiers, Communications Unit, and Accessories

Technical Guide and Precautions

Model Index

- Threaded
- Cylindrical

- Flat
- Sleeved

- Small Spot
- High Power
- Narrow view
- BGS

- Retro-reflective
- Limited-reflective

- Chemical-resistant, Oil-resistant
- Bending
- Heat-resistant

- Area Detection
- Liquid-level
- Vacuum
- FPD, Semi, Solar

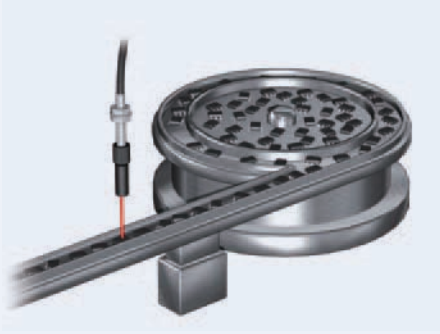

- Small-spot is ideal for detecting minute objects. Select the Fiber Unit that is best suited for the workpiece size and installation distance. (Refer to Reference Information for Model Selection)

Specifications

Reflective Fiber Units

Small-spot Models

Lens Units + Fiber Units

Type	Spot diameter	Center distance (mm)	Lens Units	Lens Units + Fiber Units	Fiber Units		23 Page Dimensions No.	
			Models	Appearance(mm)	Bending radius of cable	Models		
Short-distance, small-spot	0.1 dia.	7	E39-F3A-5		R25		E32-C41 1M	23-A
	0.5 dia.						E32-C31 2M	23-B
						Flexible, R2	E32-C21N 2M NEW	23-C
Medium-distance, small-spot	0.2 dia.	17	E39-F3B		R25		E32-C41 1M	23-D
	0.5 dia.						E32-C31 2M	23-E
						Flexible, R2	E32-C21N 2M NEW	23-F
Long-distance, small-spot	3 dia.	50	E39-F18		R25		E32-CC200 2M	23-G
					Flexible, R4	E32-C11N 2M	23-H	

* The spot diameter and the center distance are the same when using with E3X-HD series or E3NX-FA series.

Dimensions

Installation Information → 58, 61 Page

Reflective Fiber Units

23-A E32-C41 1M (No Cutting) + E39-F3A-5

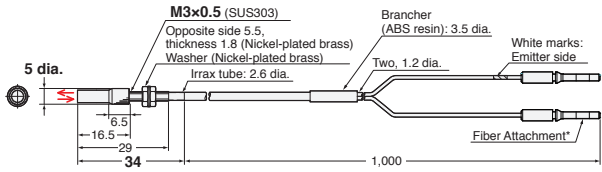

* Attached with adhesive and cannot be removed.
Note: There is a white tube on the emitter fiber.

E39-F3A-5

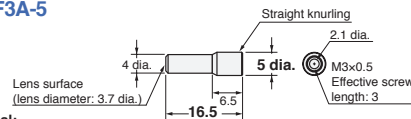

Material:
Aluminum for body and optical glass for lens

Note: This is a Lens Unit for the E32-C41, E32-C31 and E32-C31N.

23-B E32-C31 2M (Free Cutting) + E39-F3A-5

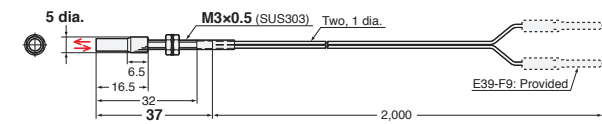

Note: There is a white line on the emitter fiber.

23-C E32-C21N 2M (Free Cutting) + E39-F3A-5

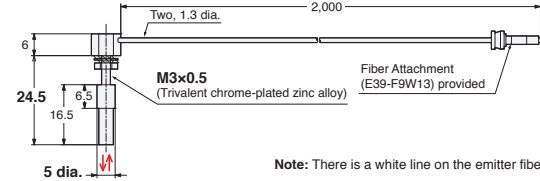

Note: There is a white line on the emitter fiber.

23-D E32-C41 1M (No Cutting) + E39-F3B

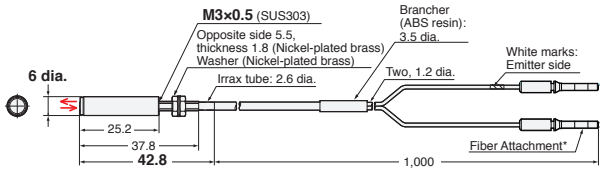

* Attached with adhesive and cannot be removed.
Note: There is a white tube on the emitter fiber.

E39-F3B

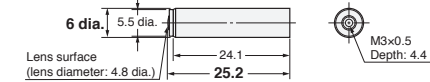

Material:
Aluminum for body and optical glass for lens

Note: This is a Lens Unit for the E32-C41, E32-C31 and E32-C31N.

23-E E32-C31 2M (Free Cutting) + E39-F3B

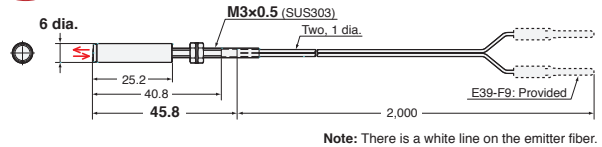

Note: There is a white line on the emitter fiber.

23-F E32-C21N 2M (Free Cutting) + E39-F3B

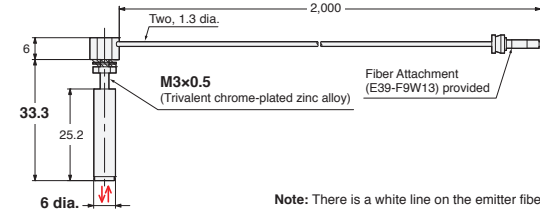

Note: There is a white line on the emitter fiber.

23-G E32-CC200 2M (Free Cutting) + E39-F18

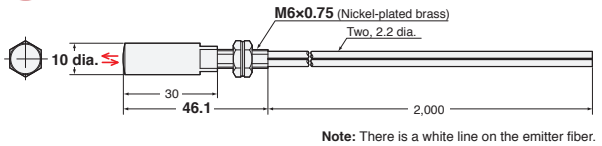

Note: There is a white line on the emitter fiber.

E39-F18

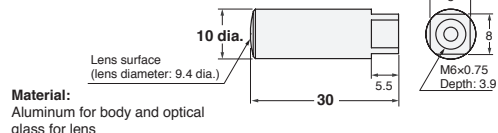

Material:
Aluminum for body and optical glass for lens

Note: This is a Lens Unit for the E32-C11N and E32-CC200.

23-H E32-C11N 2M (Free Cutting) + E39-F18

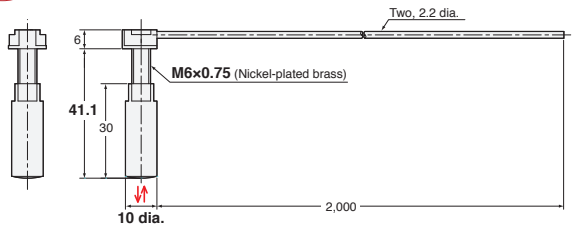

Note: There is a white line on the emitter fiber.

- Reference Information for Model Selection -

Model Selection Tips

- Select the best model by following these steps.
 - Select the model based on the spot diameter suitable for the workpiece size.
 - * The Variable-spot Type is useful if there are different sensing object sizes.
 - Select the model based on the allowable installation distance and center distance.

<Map of Spot Diameters and Center Distances>

(Unit: mm)

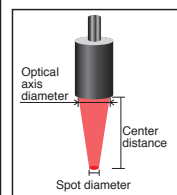

Spot diameter	0.1 dia.	0.1 dia.	0.2 dia.	0.5 dia.	0.5 dia.	3 dia.	4 dia.	6 dia.
Center distance	5	7	17	7	17	50	0 to 20	50
Optical axis diameter	2.4	3.7	4.8	3.7	4.8	9.4	3.7	10
Models	E32-C42S	E39-F3A-5 + E32-C41	E39-F3B + E32-C41	E39-F3A-5 + E32-C31 E32-C21N	E39-F3B + E32-C31 E32-C21N	E39-F18 + E32-CC200 E32-C11N	E39-F3C + E32-C31 E32-C21N	E32-L15

* Refer to page 20 for details.

Fiber Sensor Features

Selection Guide

Fiber Units

Threaded

Cylindrical

Flat

Sleeved

Small Spot

High Power

Narrow view

BGS

Retro-reflective

Limited-reflective

Chemical-resistant, Oil-resistant

Bending

Heat-resistant

Area Detection

Liquid-level

Vacuum

FPD, Semi, Solar

Installation Information

Fiber Amplifiers, Communications Unit, and Accessories

Technical Guide and Precautions

Model Index

Fiber Sensor Features

Selection Guide

Fiber Units

Standard Installation

- Threaded
- Cylindrical

Saving Space

- Flat
- Sleeved

Beam Improvements

- Small Spot
- High Power
- Narrow view
- BGS

Transparent Objects

- Retro-reflective
- Limited-reflective

Environmental Immunity

- Chemical-resistant, Oil-resistant
- Bending
- Heat-resistant

Applications

- Area Detection
- Liquid-level
- Vacuum
- FPD, Semi, Solar

Installation Information

Fiber Amplifiers, Communications Unit, and Accessories

Technical Guide and Precautions

Model Index

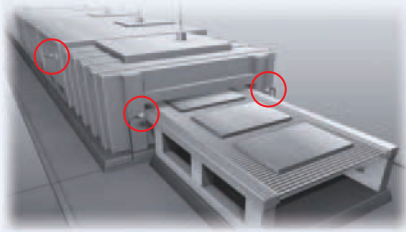

- Maximum sensing distance without attaching a Lens: 20 m (E32-T17L)
Suitable for detection of large objects and for use in large-scale installations.
- Powerful enough to resist the influences of dust and dirt.
(Refer to the comparisons of incident level on the Reference Information for Model Selection.)
- In addition to the products listed on this page, Lenses are available to extend the sensing distance. (→ 26 to 29 pages)

Specifications

Through-beam Fiber Units

Sensing direction	Aperture angle	Appearance (mm)	Bending radius of cable	Sensing distance (mm)				Optical axis diameter (minimum sensing object)	Models	25 Page Dimensions No.
				E3X-HD		E3NX-FA NEW				
				GIGA	HS	GIGA	HS			
Right-angle	15°		Flexible, R2	4,000 *1	ST : 3,500	4,000 *1	ST : 4,000	2.3 dia. (0.1 dia./0.03 dia.)	E32-LT11N 2M NEW	25-A
				2,300	SHS: 920	3,450	SHS: 920			
Top-view	10°		R25	20,000 *2	ST : 20,000	20,000 *2	ST : 20,000	10 dia.	E32-T17L 10M	25-B
				20,000 *2	SHS: 8,000	20,000 *2	SHS: 8,000			
	15°		Flexible, R1	4,000 *1	ST : 4,000	4,000 *1	ST : 4,000	2.3 dia. (0.1 dia./0.03 dia.)	E32-LT11 2M NEW	25-C
				2,700	SHS: 1,080	4,000 *1	SHS: 1,080			
Side-view	30°		R25	4,000 *1	ST : 4,000	4,000 *1	ST : 4,000	4 dia. (0.1 dia./0.03 dia.)	E32-T14 2M	25-D
				4,000 *1	SHS: 1,800	4,000 *1	SHS: 1,800			

*1 The optical fiber is 2 m long on each side, so the sensing distance is 4,000 mm.
*2 The optical fiber is 10 m long on each side, so the sensing distance is 20,000 mm.

Reflective Fiber Units

Sensing direction	Aperture angle	Appearance (mm)	Bending radius of cable	Sensing distance (mm)				Optical axis diameter (minimum sensing object)	Model	25 Page Dimensions No.
				E3X-HD		E3NX-FA NEW				
				GIGA	HS	GIGA	HS			
Top-view	4°		Bendresistant, R4	40 to 2,800	ST : 40 to 1,400	40 to 4,000	ST : 40 to 2,100	-	E32-D16 2M	25-E
				40 to 900	SHS: 40 to 480	40 to 1,350	SHS: 40 to 480			

- Note 1.** The following mode names and response times apply to the modes given in the Sensing distance column.
[E3X-HD] GIGA: Giga-power mode (16 ms), HS: High-speed mode (250 μs), ST: Standard mode (1 ms), and SHS: Super-high-speed mode (NPN output: 50 μs, PNP output: 55 μs)
[E3NX-FA] GIGA: Giga-power mode (16 ms), HS: High-speed mode (250 μs), ST: Standard mode (1 ms), and SHS: Super-high-speed mode (30 μs)
- 2.** The values for the minimum sensing object are reference values that indicate values obtained in standard mode with the sensing distance and sensitivity set to the optimum values.
The first value is for the E3X-HD and the second value is for the E3NX-FA.
- 3.** The sensing distances for Reflective Fiber Units are for white paper.

Dimensions

Through-beam Fiber Units (Set of 2)

25-A E32-LT11N 2M (Free Cutting)

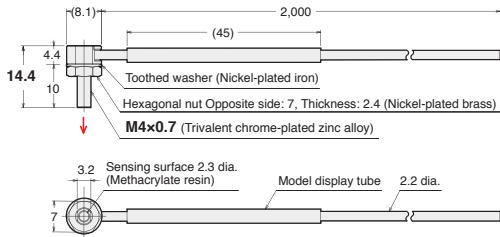

25-B E32-T17L 10M (Free Cutting)

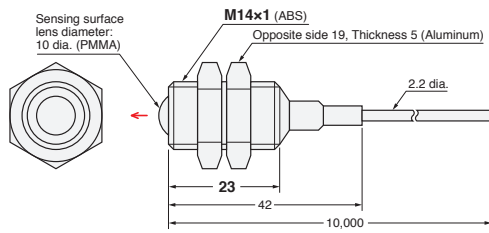

25-C E32-LT11 2M (Free Cutting)
E32-LT11R 2M (Free Cutting)

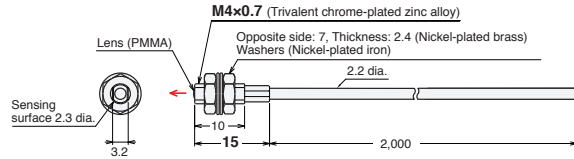

25-D E32-T14 2M (Free Cutting)

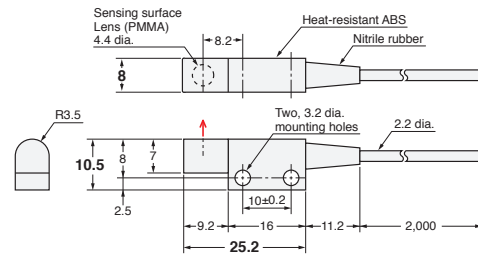

Reflective Fiber Units

25-E E32-D16 2M (Free Cutting)

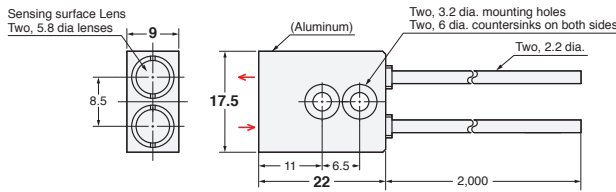

- Reference Information for Model Selection -

Comparisons of incident level

Select the model based on the comparisons of incident level against Standard Fiber Units.

Comparisons of incident level (Through-beam)

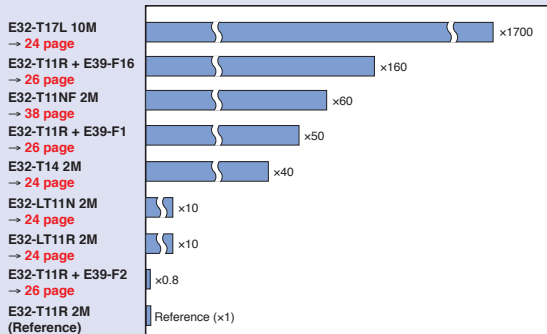

Comparisons of incident level (Reflective)

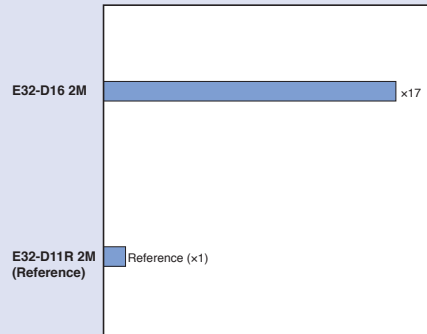

Fiber Sensor Features

Selection Guide

Fiber Units

Threaded

Cylindrical

Flat

Sleeved

Small Spot

High Power

Narrow view

BGS

Retro-reflective

Limited-reflective

Chemical-resistant, Oil-resistant

Bending

Heat-resistant

Area Detection

Liquid-level

Vacuum

FPD, Semi, Solar

Installation Information

Fiber Amplifiers, Communications Unit, and Accessories

Technical Guide and Precautions

Model Index

Specifications

Through-beam Fiber Units

Lens Units	Type	High-power (incident level: 50 times)	Ultra-high-power (incident level: 160 times)	Side-View (incident level: 0.8 times)									
	Models	E39-F1	E39-F16	E39-F2									
	Appearance												
	Aperture angle	Approx. 12°	Approx. 6°	Approx. 60°									
	Optical axis diameter (minimum sensing object)	4 dia. (0.1 dia.)	7.2 dia.	3 dia. (0.1 dia.)									
Fiber Units		Sensing distance (mm)											
Models	Appearance (mm)	E3X-HD		E3NX-FA <i>NEW</i>		E3X-HD		E3NX-FA <i>NEW</i>		E3X-HD		E3NX-FA <i>NEW</i>	
		GIGA=HS	Other modes	GIGA=HS	Other modes	GIGA=HS	Other modes	GIGA=HS	Other modes	GIGA=HS	Other modes	GIGA=HS	Other modes
E32-T11N 2M		4,000*	ST : 4,000	4,000*	ST : 4,000	4,000*	ST : 4,000	4,000*	ST : 4,000	—	—	—	—
E32-T11R 2M		4,000*	ST : 4,000	4,000*	ST : 4,000	4,000*	ST : 4,000	4,000*	ST : 4,000	1,450	ST : 800	2,170	ST : 1,200
E32-T11 2M		4,000*	ST : 4,000	4,000*	ST : 4,000	4,000*	ST : 4,000	4,000*	ST : 4,000	2,300	ST : 1,320	3,450	ST : 1,980

* The optical fiber is 2 m long on each side, so the sensing distance is 4,000 mm.

Note 1. The following mode names and response times apply to the modes given in the Sensing distance column.

[E3X-HD] GIGA: Giga-power mode (16 ms), HS: High-speed mode (250 μs), ST: Standard mode (1 ms), and SHS: Super-high-speed mode (NPN output: 50 μs, PNP output: 55 μs)
 [E3NX-FA] GIGA: Giga-power mode (16 ms), HS: High-speed mode (250 μs), ST: Standard mode (1 ms), and SHS: Super-high-speed mode (30 μs)

2. The values for the minimum sensing object are reference values that indicate values obtained in standard mode with the sensing distance and sensitivity set to the optimum values. The first value is for the E3X-HD and the second value is for the E3NX-FA.

Dimensions

Installation Information → 61 Page

Lens Units (Set of 2)

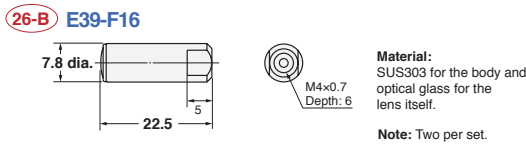
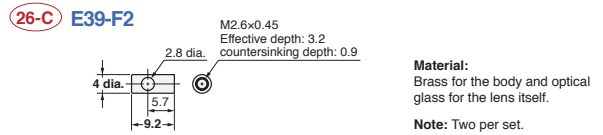
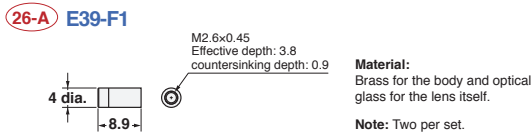

Dimensions

Installation Information → 60, 61 Page

Through-beam Fiber Units (Set of 2)

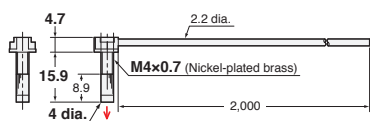
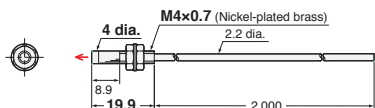
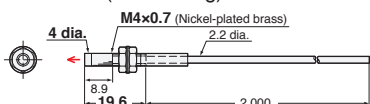
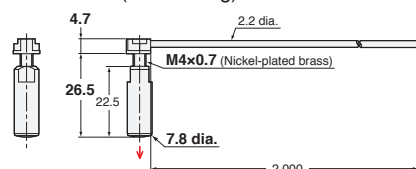
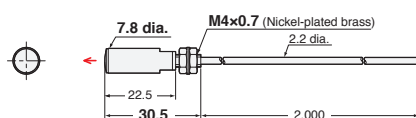
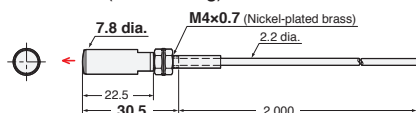
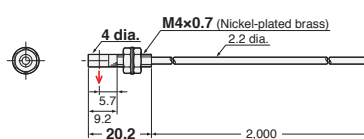
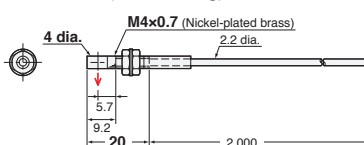
(27-A) E32-T11N 2M (Free Cutting) + E39-F1

(27-B) E32-T11R 2M (Free Cutting) + E39-F1

(27-C) E32-T11 2M (Free Cutting) + E39-F1

(27-D) E32-T11N 2M (Free Cutting) + E39-F16

(27-E) E32-T11R 2M (Free Cutting) + E39-F16

(27-F) E32-T11 2M (Free Cutting) + E39-F16

(27-G) E32-T11R 2M (Free Cutting) + E39-F2

(27-H) E32-T11 2M (Free Cutting) + E39-F2

Fiber Sensor Features

Selection Guide

Fiber Units

Threaded	Standard Installation
Cylindrical	
Flat	Saving Space
Sleeved	
Small Spot	Beam Improvements
High Power	
Narrow view	
BGS	Transparent Objects
Retro-reflective	
Limited-reflective	
Chemical-resistant, Oil-resistant	Environmental Immunity
Bending	
Heat-resistant	Applications
Area Detection	
Liquid-level	
Vacuum	FPD, Semi, Solar

Installation Information

Fiber Amplifiers, Communications Unit, and Accessories

Technical Guide and Precautions

Model Index

- Reference Information for Model Selection -

Comparisons of incident level

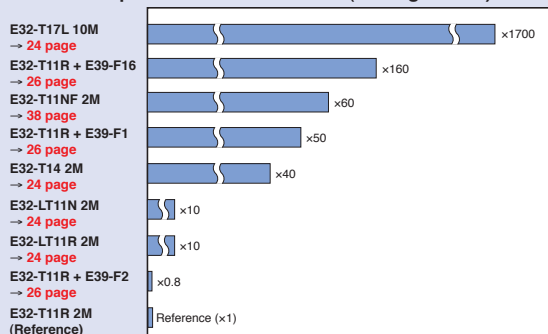

Select the model based on the comparisons of incident level against Standard Fiber Units.

Comparisons of incident level (Through-beam)



Specifications

Through-beam Fiber Units (Heat-resistant)

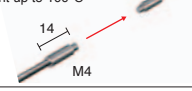
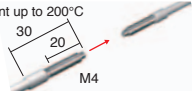
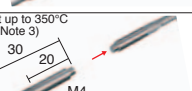
Lens Units	Type	High-power (incident level: 50 times)	Ultra-high-power (incident level: 160 times)	Side-View (incident level: 0.8 times)					
	Models	E39-F1	E39-F16	E39-F2					
	Appearance	 (28-A)	 (28-B)	 (28-C)					
	Aperture angle	Approx. 12°	Approx. 6°	Approx. 60°					
	Optical axis diameter (minimum sensing object)	4 dia. (0.1 dia.)	7.2 dia.	3 dia. (0.1 dia.)					
Fiber Units		Sensing distance (mm)							
Models	Appearance (mm)	E3X-HD		E3NX-FA <i>NEW</i>		E3X-HD		E3NX-FA <i>NEW</i>	
		GIGA=HS	Other modes	GIGA=HS	Other modes	GIGA=HS	Other modes	GIGA=HS	Other modes
E32-T51R-2M	Heat-resistant up to 100°C 	4,000*	ST : 4,000*	4,000*	ST : 4,000*	4,000*	ST : 4,000*	4,000*	ST : 4,000*
		3,900	SHS : 1,500 (29-A)	4,000*	SHS : 1,500	4,000*	SHS : 4,000* (29-D)	4,000*	SHS : 4,000*
E32-T81R-S-2M	Heat-resistant up to 200°C 	4,000*	ST : 4,000*	4,000*	ST : 4,000*	4,000*	ST : 4,000*	4,000*	ST : 4,000*
		2,700	SHS : 1,000 (29-B)	4,000*	SHS : 1,000	4,000*	SHS : 1,800* (29-E)	4,000*	SHS : 1,800*
E32-T61-S-2M	Heat-resistant up to 350°C (200°C) (See Note 3) 	4,000*	ST : 4,000*	4,000*	ST : 4,000*	4,000*	ST : 4,000*	4,000*	ST : 4,000*
		4,000*	SHS : 1,800 (29-C)	4,000*	SHS : 1,800	4,000*	SHS : 3,100* (29-F)	4,000*	SHS : 3,100*



* The optical fiber is 2 m long on each side, so the sensing distance is 4,000 mm.

Note 1. The following mode names and response times apply to the modes given in the Sensing distance column.

[E3X-HD] GIGA: Giga-power mode (16 ms), HS: High-speed mode (250 μs), ST: Standard mode (1 ms), and SHS: Super-high-speed mode (NPN output: 50 μs, PNP output: 55 μs)
[E3NX-FA] GIGA: Giga-power mode (16 ms), HS: High-speed mode (250 μs), ST: Standard mode (1 ms), and SHS: Super-high-speed mode (30 μs)

2. The values for the minimum sensing object are reference values that indicate values obtained in standard mode with the sensing distance and sensitivity set to the optimum values. The first value is for the E3X-HD and the second value is for the E3NX-FA.

3. The ambient temperature of E32-T61-S must be between -40 to 200°C when using it with E39-F1 or E39-F2 Lens Unit. The ambient temperature of E32-T61-S must be between -40 to 350°C when using it with E39-F16 Lens Unit.

Lens Units	Type	High-power (incident level: 50 times)	Ultra-high-power (incident level: 160 times)						
	Models	E39-F1-33	E39-F16						
	Appearance	 (28-D)	 (28-B)						
	Aperture angle	Approx. 12°	Approx. 6°						
	Optical axis diameter (minimum sensing object)	4 dia. (0.1 dia.)	7.2 dia.						
Fiber Units		Sensing distance (mm)							
Models	Appearance (mm)	E3X-HD		E3NX-FA <i>NEW</i>		E3X-HD		E3NX-FA <i>NEW</i>	
		GIGA=HS	Other modes	GIGA=HS	Other modes	GIGA=HS	Other modes	GIGA=HS	Other modes
E32-T51-2M	Heat-resistant up to 150°C 	4,000*	ST : 4,000*	4,000*	ST : 4,000*	4,000*	ST : 4,000*	4,000*	ST : 4,000*
		2,300	SHS : 1,400 (29-J)	3,450	SHS : 1,400	4,000*	SHS : 4,000* (29-K)	4,000*	SHS : 4,000*

* The optical fiber is 2 m long on each side, so the sensing distance is 4,000 mm.

Note 1. The following mode names and response times apply to the modes given in the Sensing distance column.

[E3X-HD] GIGA: Giga-power mode (16 ms), HS: High-speed mode (250 μs), ST: Standard mode (1 ms), and SHS: Super-high-speed mode (NPN output: 50 μs, PNP output: 55 μs)
[E3NX-FA] GIGA: Giga-power mode (16 ms), HS: High-speed mode (250 μs), ST: Standard mode (1 ms), and SHS: Super-high-speed mode (30 μs)

2. The values for the minimum sensing object are reference values that indicate values obtained in standard mode with the sensing distance and sensitivity set to the optimum values. The first value is for the E3X-HD and the second value is for the E3NX-FA.

Dimensions

Installation Information → 61 Page

Lens Units (Set of 2)

(28-A) E39-F1

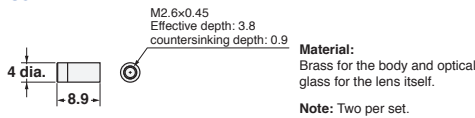

(28-C) E39-F2

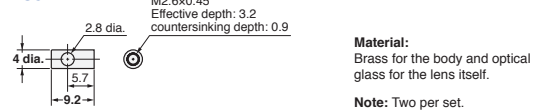

(28-B) E39-F16

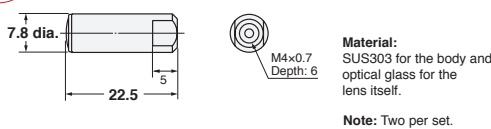

(28-D) E39-F1-33

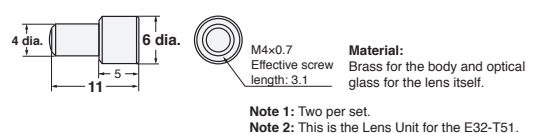

Dimensions

Installation Information → 60, 61 Page

Through-beam Fiber Units (Set of 2)

29-A E32-T51R 2M (Free Cutting) + E39-F1

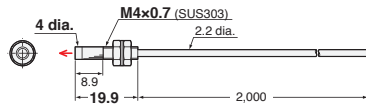

29-B E32-T81R-S 2M (No Cutting) + E39-F1

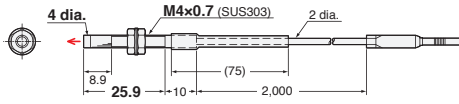

29-C E32-T61-S 2M (No Cutting) + E39-F1

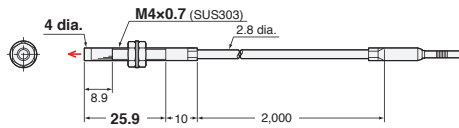

29-G E32-T51R 2M (Free Cutting) + E39-F2

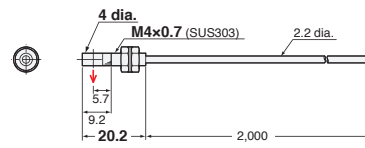

29-H E32-T81R-S 2M (No Cutting) + E39-F2

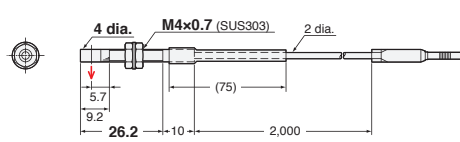

29-I E32-T61-S 2M (No Cutting) + E39-F2

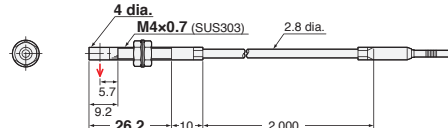

29-D E32-T51R 2M (Free Cutting) + E39-F16

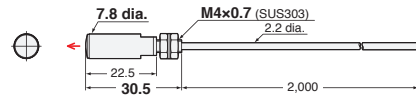

29-E E32-T81R-S 2M (No Cutting) + E39-F16

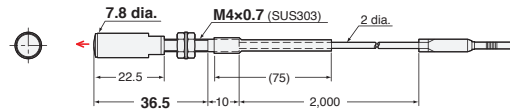

29-F E32-T61-S 2M (No Cutting) + E39-F16

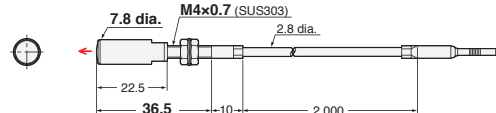

29-J E32-T51 2M (Free Cutting) + E39-F1-33

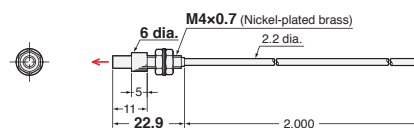

29-K E32-T51 2M (Free Cutting) + E39-F16

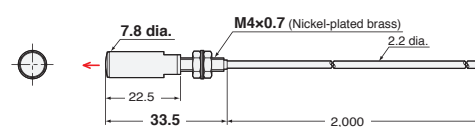

- Reference Information for Model Selection -

Comparisons of incident level

Select the model based on the comparisons of incident level against Standard Fiber Units.

Comparisons of incident level (Through-beam)

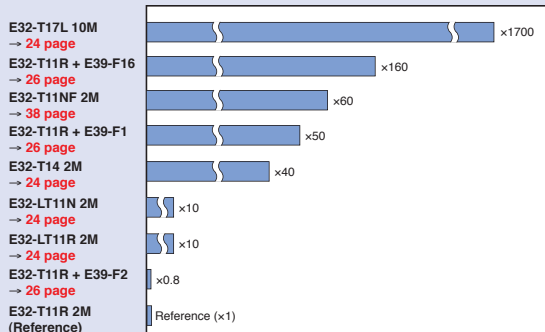

Fiber Sensor Features

Selection Guide

Fiber Units

Threaded

Standard Installation

Cylindrical

Flat

Saving Space

Sleeved

Small Spot

High Power

Beam Improvements

Narrow view

BGS

Retro-reflective

Transparent Objects

Limited-reflective

Chemical-resistant, Oil-resistant

Environmental Immunity

Bending

Heat-resistant

Area Detection

Liquid-level

Applications

Vacuum

FPD, Semi, Solar

Installation Information

Fiber Amplifiers, Communications Unit, and Accessories

Technical Guide and Precautions

Model Index

Threaded

Cylindrical

Flat

Sleeved

Small Spot

High Power

Narrow view

BGS

Retro-reflective

Limited-reflective

Chemical-resistant, Oil-resistant

Bending

Heat-resistant

Area Detection

Liquid-level

Vacuum

FPD, Semi, Solar

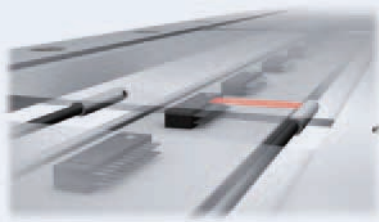

- The fine beam prevents false detection of light that is reflected off surrounding objects.

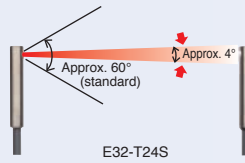

Specifications

Through-beam Fiber Units

Sensing direction	Aperture angle	Appearance (mm)	Bending radius of cable	Sensing distance (mm)				Optical axis diameter (minimum sensing object)	Models	31 Page Dimensions No.
				E3X-HD		E3NX-FA <i>NEW</i>				
				GIGA-HS	Other modes	GIGA-HS	Other modes			
Side-view	1.5°		Flexible, R1	4,000*	ST : 1,780	4,000*	ST : 2,670	2 dia. (0.1 dia./ 0.03 dia.)	E32-A03 2M	31-A
				1,200	SHS: 500	1,800	SHS: 500			
	3.4°		R10	1,280	ST : 680	1,920	ST : 1,020	1.2 dia. (0.1 dia./ 0.03 dia.)	E32-A04 2M	31-C
				450	SHS: 200	670	SHS: 200			
	4°		Flexible, R1	4,000*	ST : 2,200	4,000*	ST : 3,300	2 dia. (0.1 dia./ 0.03 dia.)	E32-T24SR 2M	31-D
				1,460	SHS: 580	2,190	SHS: 580			
R10		R10	4,000*	ST : 2,600	4,000*	ST : 3,900	2 dia. (0.1 dia./ 0.03 dia.)	E32-T24S 2M	31-E	
			1,740	SHS: 700	2,610	SHS: 700				
Top-view			R10	4,000*	ST : 3,800	4,000*	ST : 4,000	1.7 dia. (0.1 dia./ 0.03 dia.)	E32-T22S 2M	31-F
				2,500	SHS: 1,000	3,750	SHS: 1,000			

* The optical fiber is 2 m long on each side, so the sensing distance is 4,000 mm.

Note 1. The following mode names and response times apply to the modes given in the Sensing distance column.

[E3X-HD] GIGA: Giga-power mode (16 ms), HS: High-speed mode (250 μs), ST: Standard mode (1 ms), and SHS: Super-high-speed mode (NPN output: 50 μs, PNP output: 55 μs)

[E3NX-FA] GIGA: Giga-power mode (16 ms), HS: High-speed mode (250 μs), ST: Standard mode (1 ms), and SHS: Super-high-speed mode (30 μs)

2. The values for the minimum sensing object are reference values that indicate values obtained in standard mode with the sensing distance and sensitivity set to the optimum values. The first value is for the E3X-HD and the second value is for the E3NX-FA.

Threaded
Cylindrical

Flat
Sleeved

Small Spot
High Power
Narrow view
BGS

Retro-reflective
Limited-reflective

Chemical-resistant, Oil-resistant
Bending
Heat-resistant

Area Detection
Liquid-level
Vacuum
FPD, Semi, Solar

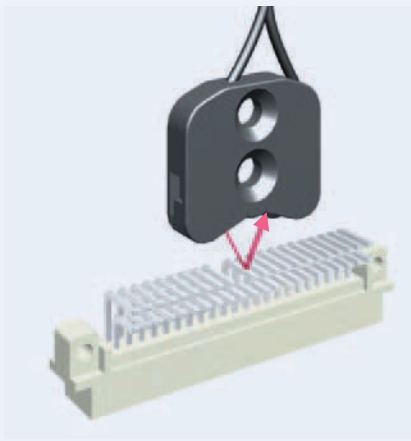

- These Fiber Units detect only objects in the sensing range. Objects in the background that are located beyond a certain point are not detected. They are not easily affected by the material or color of the sensing object.

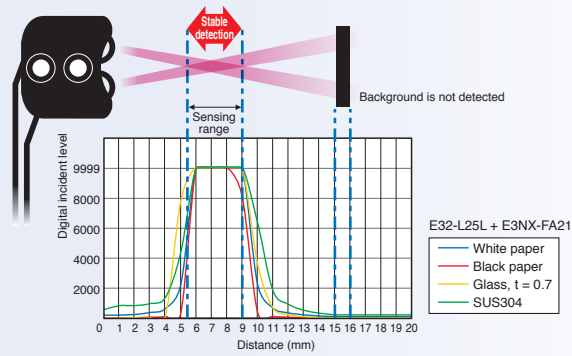

Specifications

Limited-reflective Fiber Units

Sensing direction	Appearance (mm)	Bending radius of cable	Sensing distance (mm)				Standard sensing object (minimum sensing object)	Models	33 Page Dimensions No.
			E3X-HD		E3NX-FA <i>NEW</i>				
			GIGA	HS	GIGA	HS			
Flat-view		R25	0 to 15	ST : 0 to 15	0 to 15	ST : 0 to 15	Soda glass with reflection factor of 7%	E32-L16-N 2M	33-A
			0 to 15	SHS: 0 to 12	0 to 15	SHS: 0 to 12			
Side-view		R10	0 to 4	ST : 0 to 4	0 to 4	ST : 0 to 4	(5 μm dia./ 2 μm dia.)	E32-L24S 2M	33-B
			0 to 4	SHS: 0 to 4	0 to 4	SHS: 0 to 4			
Side-view		R10	5.4 to 9	ST : 5.4 to 9	5.4 to 9	ST : 5.4 to 9	(5 μm dia./ 2 μm dia.)	E32-L25L 2M	33-C
			5.4 to 9 (Center 7.2)	SHS: 5.4 to 9 (Center 7.2)	5.4 to 9 (Center 7.2)	SHS: 5.4 to 9 (Center 7.2)			

- Note 1.** If operation is affected by the background, perform power tuning or use the ECO Mode to decrease the incident light level.
- 2.** The following mode names and response times apply to the modes given in the Sensing distance column.
 [E3X-HD] GIGA: Giga-power mode (16 ms), HS: High-speed mode (250 μs), ST: Standard mode (1 ms), and SHS: Super-high-speed mode (NPN output: 50 μs, PNP output: 55 μs)
 [E3NX-FA] GIGA: Giga-power mode (16 ms), HS: High-speed mode (250 μs), ST: Standard mode (1 ms), and SHS: Super-high-speed mode (30 μs)
- 3.** The values for the minimum sensing object are reference values that indicate values obtained in standard mode with the sensing distance and sensitivity set to the optimum values. The first value is for the E3X-HD and the second value is for the E3NX-FA.
- 4.** The sensing distances for Reflective Fiber Units are for white paper.

Dimensions

Installation Information → 59 Page

Limited-reflective Fiber Units

33-A E32-L16-N 2M (Free Cutting)

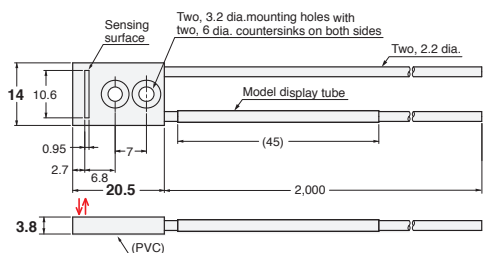

33-B E32-L24S 2M (Free Cutting)

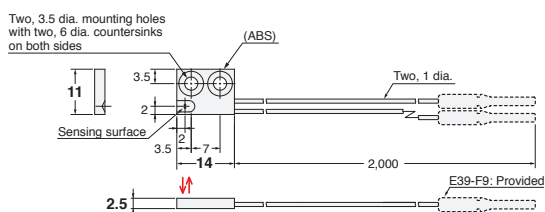

33-C E32-L25L 2M (Free Cutting)

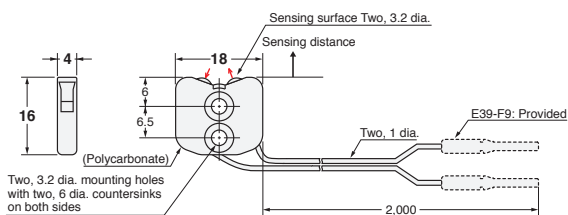

- Reference Information for Model Selection -

Sensing Distance vs. Digital Value

The following graphs show how the digital value is high within the sensing range and small outside. This explains why false detection does not occur outside the sensing range, even against common metal backgrounds, such as stainless steel.

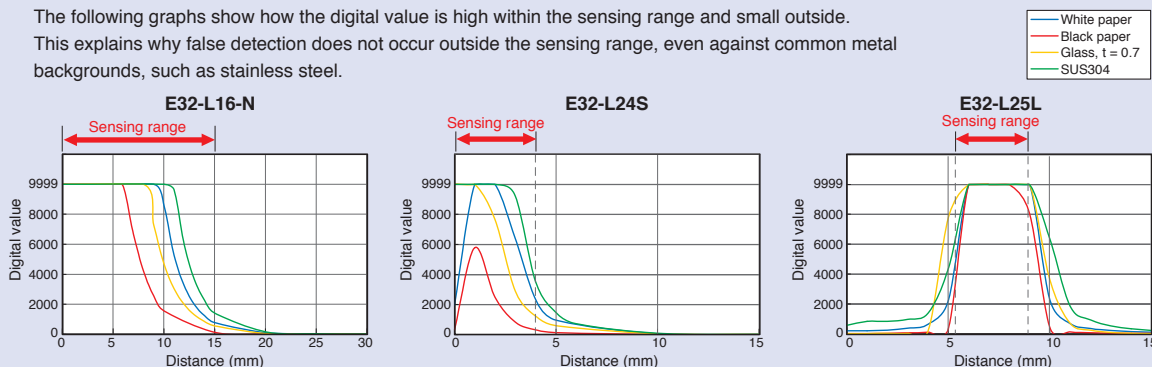

* E3NX-FA21 used in high-speed (HS) mode

Fiber Sensor Features

Selection Guide

Fiber Units

Threaded

Cylindrical

Flat

Sleeved

Small Spot

High Power

Narrow view

BGS

Retro-reflective

Limited-reflective

Chemical-resistant, Oil-resistant

Bending

Heat-resistant

Area Detection

Liquid-level

Vacuum

FPD, Semi, Solar

Installation Information

Fiber Amplifiers, Communications Unit, and Accessories

Technical Guide and Precautions

Model Index

- Threaded
- Cylindrical

- Flat
- Sleeved

- Small Spot
- High Power
- Narrow view
- BGS

- Retro-reflective
- Limited-reflective

- Chemical-resistant, Oil-resistant
- Bending
- Heat-resistant

- Area Detection
- Liquid-level
- Vacuum
- FPD, Semi, Solar

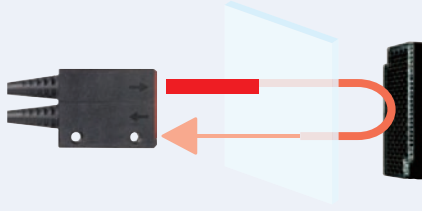

- Retro-reflective Fiber Units are ideal for detecting transparent objects. The light beam passes through the object twice, this model interrupts light more than Through-beam model.

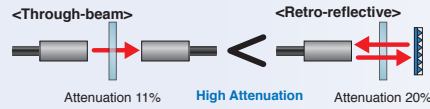

- Excellent detection performance with transparent films. (E32-LR11NP + E39-RP1)
The specially designed filter eliminates undesirable light, which allows significantly more light to be interrupted for stable detection of films.

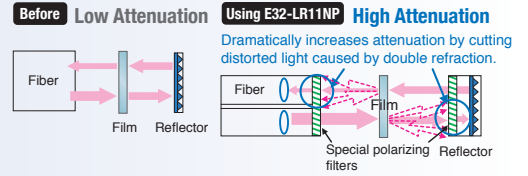
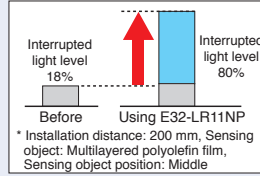

Specifications

Retro-reflective Fiber Units (With M.S.R. Function)

Type		Appearance (mm)	Bending radius of cable	Sensing distance (mm)				Optical axis diameter (minimum sensing object)	Models	35 Page Dimensions No.
Features	Size			E3X-HD		E3NX-FA <i>NEW</i>				
				GIGA=HS	Other modes	GIGA=HS	Other modes			
Film detection *	M6		Flexible, R2	1,350	ST : 1,200	2,020	ST : 1,800	-	E32-LR11NP 2M + E39-RP1 <i>NEW</i>	
				1,000	SHS: 550	1,500	SHS: 550			
Square	—		R25	150 to 1,500	ST : 150 to 1,500	150 to 1,500	ST : 150 to 1,500	(0.2 dia./ 0.07 dia.)	E32-R16 2M	
Threaded Models	M6		R10	10 to 250	ST : 10 to 250	10 to 370	ST : 10 to 370	(0.1 dia./ 0.03 dia.)	E32-R21 2M	

* This effect may not be as strong for some films. Check suitability beforehand.

Note 1. Objects with a high reflection factor may cause the Fiber Sensor to detect reflected light as incident light. Also, stable detection may not be possible for transparent objects. Check suitability beforehand.

2. The following mode names and response times apply to the modes given in the Sensing distance column.

[E3X-HD] GIGA: Giga-power mode (16 ms), HS: High-speed mode (250 μs), ST: Standard mode (1 ms), and SHS: Super-high-speed mode (NPN output: 50 μs, PNP output: 55 μs)
[E3NX-FA] GIGA: Giga-power mode (16 ms), HS: High-speed mode (250 μs), ST: Standard mode (1 ms), and SHS: Super-high-speed mode (30 μs)

3. The values for the minimum sensing object are reference values that indicate values obtained in standard mode with the sensing distance and sensitivity set to the optimum values. The first value is for the E3X-HD and the second value is for the E3NX-FA.

Dimensions

Installation Information → 58, 59 and 61 Page

Retro-reflective Fiber Units (With M.S.R. Function)

35-A E32-LR11NP 2M (Free Cutting)

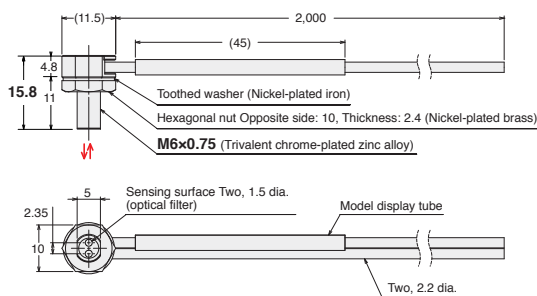

E39-RP1

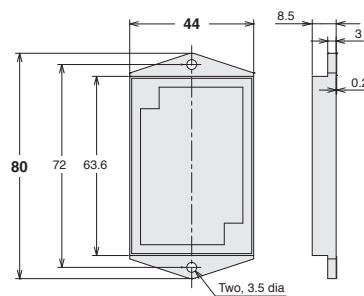

Material:
-Reflective surface> Methacrylate resin
-Back> ABS

35-B E32-R16 2M (Free Cutting)

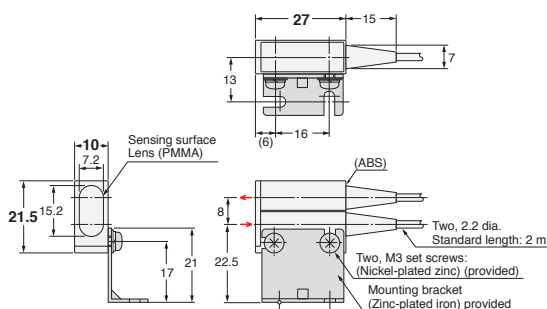

E39-R1 (Provided)

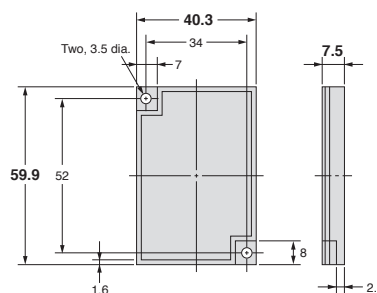

Material:
-Reflective surface> Methacrylate resin
-Back> ABS

35-C E32-R21 2M (Free Cutting)

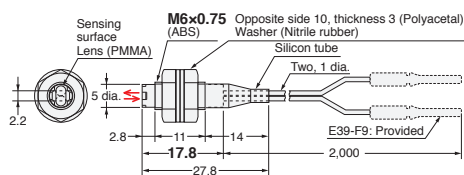

E39-R3 (Provided)

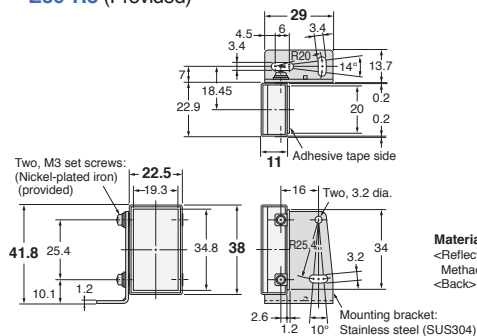

Material:
-Reflective surface> Methacrylate resin
-Back> ABS

- Reference Information for Model Selection -

Performance Comparison of Transparent Object Detection



For detecting transparent objects, consider using following products together: E32-LR11NP 2M + E39-RP1.

- This configuration features a special built-in optical filter that ensures stable detection of double-refractive materials, such as films and PET bottles.
- The retro-reflective model is suitable for detecting glass.

Sensing object	Film wrapper on cigarette packs	PET bottles	Glass bottles	Plate glass, t: 0.7
Models				
E32-LR11NP 2M + E39-RP1	○	○	○	○
E32-R16 2M	△	△	○	○
E32-R21 2M	△	△	○	○

E32-LR11NP Usage in Combination with a Sheet Reflector

Reference values of sensing distance are provided in the following table.

Reflector shape (mm)	Sensing distance (mm) (reference values)				Models
	E3X-HD		E3NX-FA NEW		
	GIGA	HS	GIGA	HS	
 50 12	550	ST : 500	820	ST : 750	E39-RSP1
	430	SHS: 250	640	SHS: 250	
 13.7 23	210	ST : 190	310	ST : 280	E39-RP37
	160	-	240	-	

Fiber Sensor Features

Selection Guide

Fiber Units

Threaded
Standard Installation

Cylindrical
Saving Space

Flat
Saving Space

Sleeved
Saving Space

Small Spot
Beam Improvements

High Power
Beam Improvements

Narrow view
Beam Improvements

BGS
Beam Improvements

Retro-reflective
Transparent Objects

Limited-reflective
Transparent Objects

Chemical-resistant, Oil-resistant
Environmental Immunity

Bending
Environmental Immunity

Heat-resistant
Environmental Immunity

Area Detection
Applications

Liquid-level
Applications

Vacuum
Applications

FPD, Semi, Solar
Applications

Installation Information

Fiber Amplifiers, Communications Unit, and Accessories

Technical Guide and Precautions

Model Index

- Threaded
- Cylindrical

- Flat
- Sleeved

- Small Spot
- High Power
- Narrow view
- BGS

- Retro-reflective
- Limited-reflective

- Chemical-resistant, Oil-resistant
- Bending
- Heat-resistant

- Area Detection
- Liquid-level
- Vacuum
- FPD, Semi, Solar

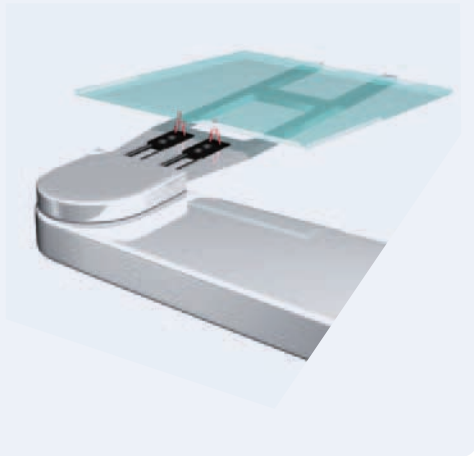

- These Fiber Units are based on a limited-reflective optical system where the emitting light and receiving light axes intersect at the same angle. This allows for stable detection of glass because the Fiber Units receives the specular reflection of the glass when the glass is in the sensing range.

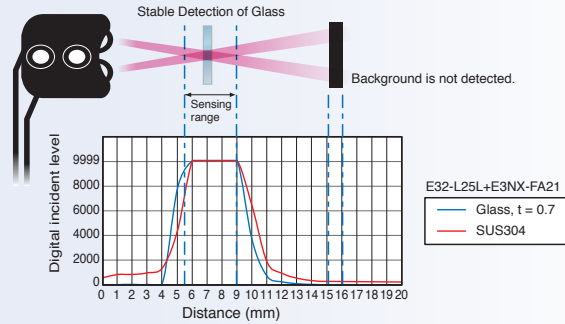

Specifications

Limited-reflective Fiber Units

Type	Features	Detection direction	Appearance (mm)	Bending radius of cable	Sensing distance (mm)				Standard sensing object (minimum sensing object)	Models	37 Page Dimensions No.
					E3X-HD		E3NX-FA <i>NEW</i>				
					GIGA	HS	Other modes	GIGA			
Standard	Flat-view	Glass-substrate alignment, 70°C	 14, 2.5, 11, IP50	R10	0 to 4 0 to 4	ST : 0 to 4 SHS: 0 to 4	0 to 4 0 to 4	ST : 0 to 4 SHS: 0 to 4	(5 μm dia./ 2 μm dia.)	E32-L24S 2M	37-A
			 20.5, 3.8, 14, IP40	R25	0 to 15 0 to 15	ST : 0 to 15 SHS: 0 to 12	0 to 15 0 to 15	ST : 0 to 15 SHS: 0 to 12	Soda glass with reflection factor of 7%	E32-L16-N 2M	37-B
			 24.5, 51, 14, IP40	R25	10 to 20 10 to 20	ST : 10 to 20 SHS: -	10 to 20 10 to 20	ST : 10 to 20 SHS: -		E32-A08 2M	37-C
			 24.5, 51, 14, IP40	R25	12 to 30 12 to 30	ST : 12 to 30 SHS: -	12 to 30 12 to 30	ST : 12 to 30 SHS: -		E32-A12 2M	37-D
Side View form	Side-view	 4, 18, 16, IP50	R10	5.4 to 9 5.4 to 9 (Center 7.2)	ST : 5.4 to 9 SHS: 5.4 to 9 (Center 7.2)	5.4 to 9 5.4 to 9 (Center 7.2)	ST : 5.4 to 9 SHS: 5.4 to 9 (Center 7.2)	(5 μm dia./ 2 μm dia.)	E32-L25L 2M	37-E	
Glass-substrate Mapping, 70°C	Top-view	 23, 9, 20, IP40	R25	15 to 38 15 to 38 (Center 25)	ST : 15 to 38 (Center 25) SHS: -	15 to 38 15 to 38 (Center 25)	ST : 15 to 38 (Center 25) SHS: -	End surface of soda glass with reflection factor of 7% (t = 0.7 mm, rounded edges)	E32-A09 2M	37-F	

* If operation is affected by the background, perform power tuning to decrease the incident light level.

Note 1. The following mode names and response times apply to the modes given in the Sensing distance column.

[E3X-HD] GIGA: Giga-power mode (16 ms), HS: High-speed mode (250 μs), ST: Standard mode (1 ms), and SHS: Super-high-speed mode (NPN output: 50 μs, PNP output: 55 μs)
 [E3NX-FA] GIGA: Giga-power mode (16 ms), HS: High-speed mode (250 μs), ST: Standard mode (1 ms), and SHS: Super-high-speed mode (30 μs)

2. The values for the minimum sensing object are reference values that indicate values obtained in standard mode with the sensing distance and sensitivity set to the optimum values.

The first value is for the E3X-HD and the second value is for the E3NX-FA.

3. The sensing distances for Reflective Fiber Units are for white paper.

Dimensions

Installation Information → 58, 59 Page

Limited-reflective Fiber Units

37-A E32-L24S 2M (Free Cutting)

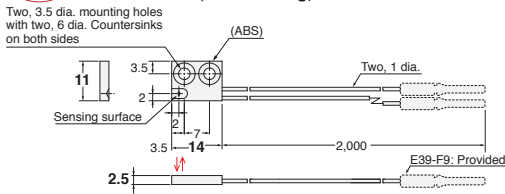

37-B E32-L16-N 2M (Free Cutting)

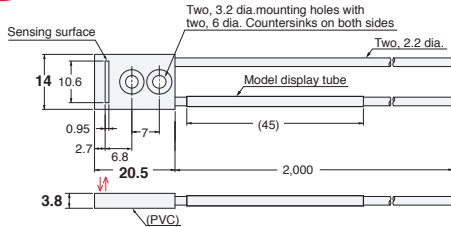

37-C E32-A08 2M (Free Cutting)

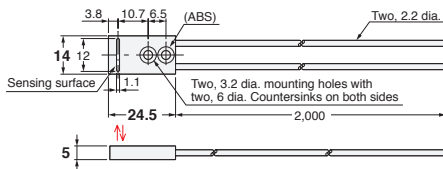

37-D E32-A12 2M (Free Cutting)

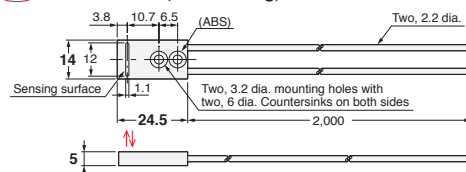

37-E E32-L25L 2M (Free Cutting)

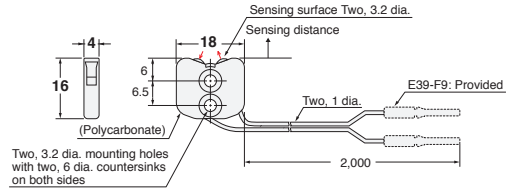

37-F E32-A09 2M (Free Cutting)

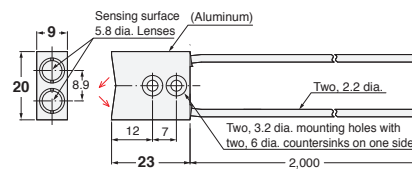

- Reference Information for Model Selection -

Sensing Distance vs. Digital Value

Limited-reflective Fiber Unit can keep high digital value within the sensing area for glass.
The digital value gets lower out of the sensing area for metals, including SUS (common as background).

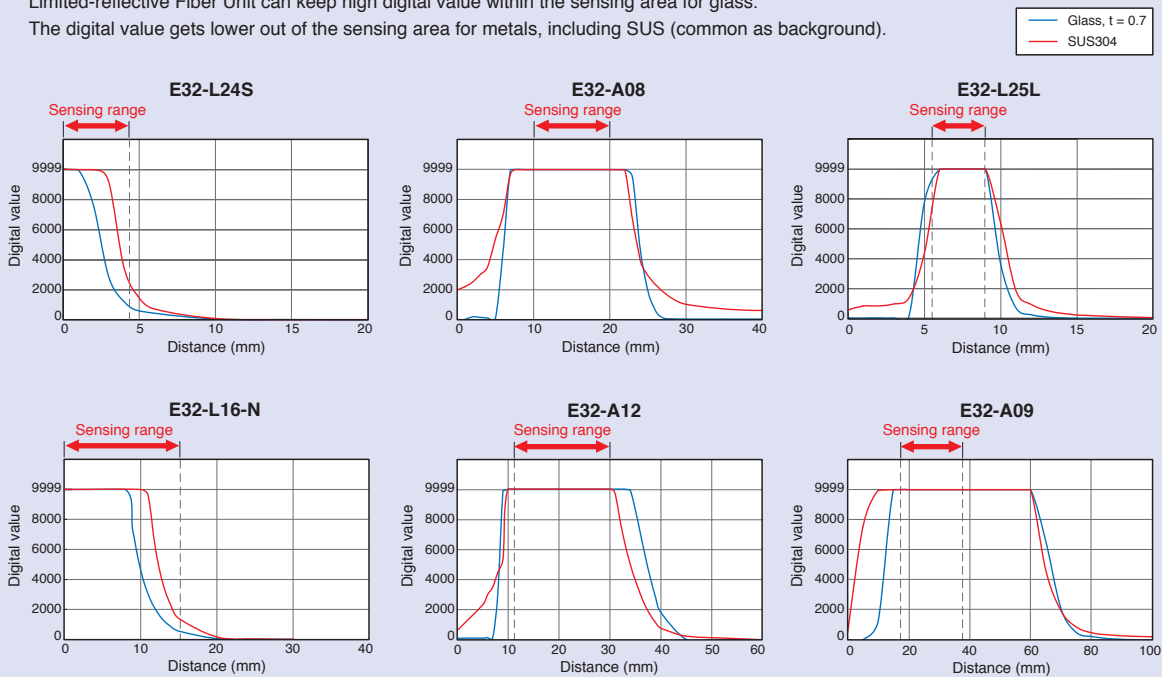

* E3NX-FA21 used in high-speed (HS) mode.

Fiber Sensor Features

Selection Guide

Fiber Units

Threaded

Cylindrical

Flat

Sleeved

Small Spot

High Power

Narrow view

BGS

Retro-reflective

Limited-reflective

Chemical-resistant, Oil-resistant

Bending

Heat-resistant

Area Detection

Liquid-level

Vacuum

FPD, Semi, Solar

Installation Information

Fiber Amplifiers, Communications Unit, and Accessories

Technical Guide and Precautions

Model Index

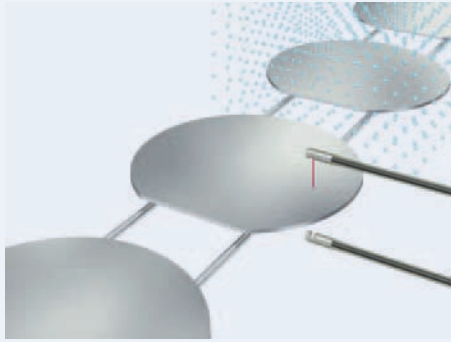

• These Fiber Units are made from fluororesin for resistance to chemicals.

Chemical-resistant Data for Fluororesin (Reference)

Material	Fluororesin	Acryl	ABS	Polycarbonate	Polyethylene	PVC
Hydrochloric acid	◎	△	△	△	△	×
Sulfuric acid	◎	×	×	×	×	×
Sodium hydroxide	◎	△	△	×	○	×
Methyl alcohol	◎	×	△	×	○	×
Acetone	◎	×	×	×	△	×
Toluene	◎	△	×	×	△	×
Benzene	◎	△	△	×	△	×

Note: Results depend on concentration.

Specifications

Through-beam Fiber Units

Type	Sensing direction	Appearance (mm)	Bending radius of cable	Sensing distance (mm)				Optical axis diameter (minimum sensing object)	Models	39 Page Dimensions No.	
				E3X-HD		E3NX-FA NEW					
				GIGA	HS	GIGA	HS				
Oil-resistant	Right-angle		Flexible, R1	4,000 *1	ST : 4,000	4,000 *1	ST : 4,000	4 dia. (0.1 dia./0.03 dia.)	E32-T11NF 2M	39-A	
				4,000 *1	SHS: 2,200	4,000 *1	SHS: 2,200				
Chemical/oil resistant	Top-view		R40	4,000 *1	ST : 4,000	4,000 *1	ST : 4,000		3 dia. (0.1 dia./0.03 dia.)	E32-T12F 2M	39-B
				4,000 *1	SHS: 1,600	4,000 *1	SHS: 1,600				
	Side-view		R4	4,000 *1	ST : 4,000	4,000 *1	ST : 4,000			E32-T11F 2M	39-C
				2,600	SHS: 1,000	3,900	SHS: 1,000				
Chemical/oil resistant 150°C *2	Top-view		R40	1,400	ST : 800	2,100	ST : 1,200	4 dia. (0.1 dia./0.03 dia.)	E32-T14F 2M	39-D	
				500	SHS: 200	750	SHS: 200				
Chemical/oil resistant 150°C *2	Top-view		R40	4,000 *1	ST : 2,800	4,000 *1	ST : 4,000	4 dia. (0.1 dia./0.03 dia.)	E32-T51F 2M	39-E	
				1,800	SHS: 700	2,700	SHS: 700				

*1 The optical fiber is 2 m long on each side, so the sensing distance is 4,000 mm.
 *2 For continuous operation, use the Fiber Unit between -40 and 130°C.

Reflective Fiber Units

Type	Sensing direction	Appearance (mm)	Bending radius of cable	Sensing distance (mm)				Standard sensing object (minimum sensing object)	Models	39 Page Dimensions No.
				E3X-HD		E3NX-FA NEW				
				GIGA	HS	GIGA	HS			
Semiconductors: Cleaning, developing, and etching, 60°C	Top-view		R40	8 to 20 mm from tip of lens (Recommended sensing distance: 11 mm) 19 to 31 mm from center of mounting hole A (Recommended sensing distance: 22 mm)				Glass (t=0.7 mm)	E32-L11FP 2M	39-F
				8 to 20 mm from tip of lens (Recommended sensing distance: 11 mm) 32 to 44 mm from center of mounting hole A (Recommended sensing distance: 35 mm)						
Semiconductors: Resist stripping, 85°C	Top-view		R40	GIGA -	ST : 190	GIGA -	ST : 280	(5 µm dia./2 µm dia.)	E32-L11FS 2M	39-G
Chemical/oil resistant				130	SHS: 60	190	SHS: 60			
	Only cable: chemical resistant		R4	840	ST : 350	1,260	ST : 520		E32-D12F 2M	39-H
240				SHS: 100	360	SHS: 100				

Note 1. The following mode names and response times apply to the modes given in the Sensing distance column.
 [E3X-HD] GIGA: Giga-power mode (16 ms), HS: High-speed mode (250 µs), ST: Standard mode (1 ms), and SHS: Super-high-speed mode (NPN output: 50 µs, PNP output: 55 µs)
 [E3NX-FA] GIGA: Giga-power mode (16 ms), HS: High-speed mode (250 µs), ST: Standard mode (1 ms), and SHS: Super-high-speed mode (30 µs)
 2. The values for the minimum sensing object are reference values that indicate values obtained in standard mode with the sensing distance and sensitivity set to the optimum values. The first value is for the E3X-HD and the second value is for the E3NX-FA.
 3. The sensing distances for Reflective Fiber Units are for white paper.

Dimensions

Installation Information → 60 Page

Through-beam Fiber Units (Set of 2)

39-A E32-T11NF 2M (Free Cutting)

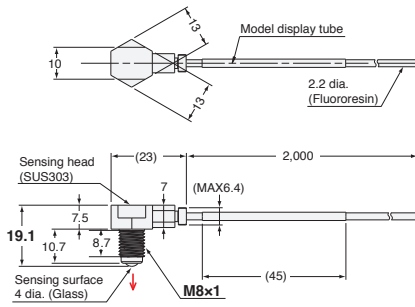

39-B E32-T12F 2M (Free Cutting)

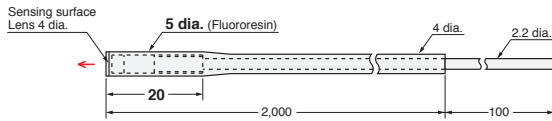

39-C E32-T11F 2M (Free Cutting)

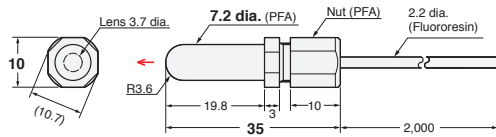

39-D E32-T14F 2M (Free Cutting)

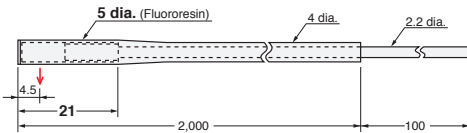

39-E E32-T51F 2M (Free Cutting)

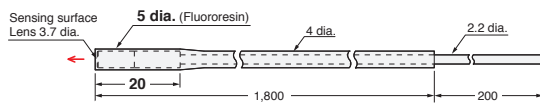

Installation Information → 58, 59 Page

Reflective Fiber Units

39-F E32-L11FP 2M (Free Cutting)

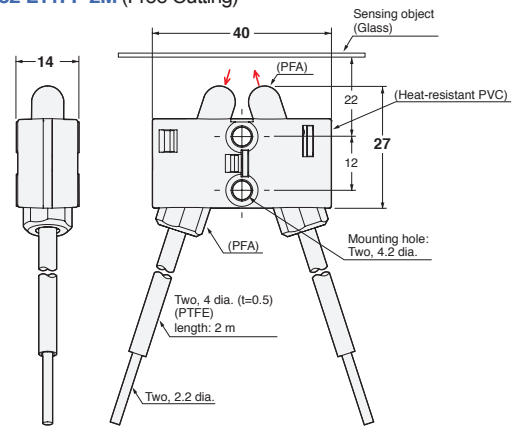

39-G E32-L11FS 2M (Free Cutting)

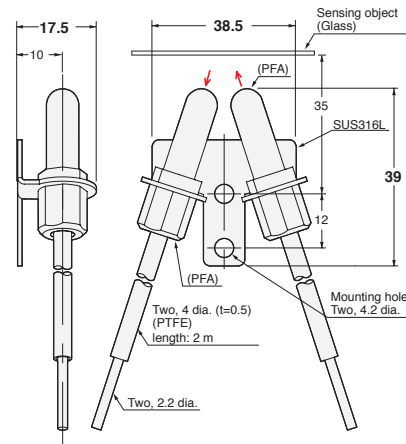

39-H E32-D12F 2M (Free Cutting)

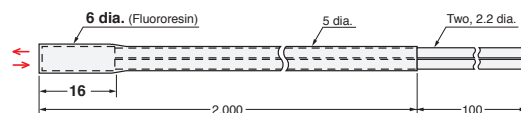

39-I E32-D11U 2M (Free Cutting)

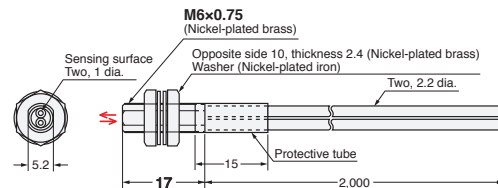

- Reference Information for Model Selection -

Oil-resistance performance of the E32-T11NF

This diagram explains why the new E32-T11NF is oil resistant.

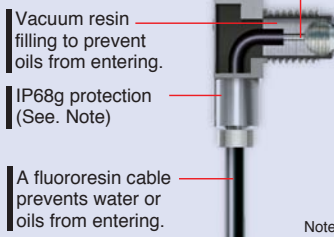

No danger of shorting since no electrical circuits are used.

Note: Equivalent to IP68g of JIS C0920 Annex 1.

Fiber Sensor Features

Selection Guide

Fiber Units

Threaded

Cylindrical

Flat

Sleeved

Small Spot

High Power

Narrow view

BGS

Retro-reflective

Limited-reflective

Chemical-resistant, Oil-resistant

Bending

Heat-resistant

Area Detection

Liquid-level

Vacuum

FPD, Semi, Solar

Installation Information

Fiber Amplifiers, Communications Unit, and Accessories

Technical Guide and Precautions

Model Index

Fiber Sensor Features

Selection Guide

Fiber Units

Standard Installation

Saving Space

Beam Improvements

Transparent Objects

Environmental Immunity

Applications

Installation Information

Fiber Amplifiers, Communications Unit, and Accessories

Technical Guide and Precautions

Model Index

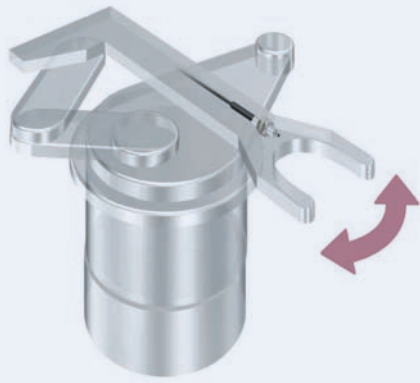

- Capable of withstanding one million repeated bends.

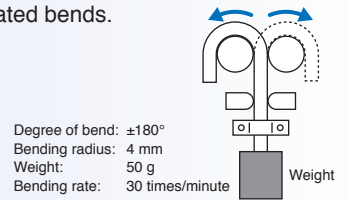

- A large number of independent fine fibers ensures good flexibility. Suitable for use on moving parts without easily breaking.



- Protective Stainless Spiral Tube is available for covering the fiber cable to protect it from accidental breaking due to snagging or shock.

Specifications

Through-beam Fiber Units

Size	Appearance (mm)	Bending radius of cable	Sensing distance (mm)					Optical axis diameter (minimum sensing object)	Models	41 Page Dimensions No.
			E3X-HD			E3NX-FA <i>NEW</i>				
			GIGA	HS	Other modes	GIGA	HS			
1.5 dia.		Bendresistant, R4	680	ST : 400	1,020	ST : 600	0.5 dia. (5 μm dia./ 2 μm dia.)	E32-T22B 2M	41-A	
M3			220	SHS: 90	330	SHS: 90		E32-T21 2M	41-B	
M4			2,500	ST : 1,350	3,750	ST : 2,020		1 dia. (5 μm dia./ 2 μm dia.)	E32-T11 2M	41-C
Square			500	ST : 300	750	ST : 450		0.5 dia. (5 μm dia./ 2 μm dia.)	E32-T25XB 2M	41-D
			170	SHS: 70	250	SHS: 70				

Note The following mode names and response times apply to the modes given in the Sensing distance column.
 1. [E3X-HD] GIGA: Giga-power mode (16 ms), HS: High-speed mode (250 μs), ST: Standard mode (1 ms), and SHS: Super-high-speed mode (NPN output: 50 μs, PNP output: 55 μs)
 [E3NX-FA] GIGA: Giga-power mode (16 ms), HS: High-speed mode (250 μs), ST: Standard mode (1 ms), and SHS: Super-high-speed mode (30 μs)
 The values for the minimum sensing object are reference values that indicate values obtained in standard mode with the sensing distance and sensitivity set to the optimum values.
 2. The first value is for the E3X-HD and the second value is for the E3NX-FA.

Protective Stainless Spiral Tube (Sold separately)

Insert the fiber cable into the protective tube to prevent breaking by snagging or shock.

Applicable Fiber Units	Model	Quantity	41 Page Dimensions No.
E32-T11R 2M/E32-T11 2M/ E32-LT11 2M/E32-LT11R 2M/ E32-T51R 2M/E32-T51 2M	E30-F32C 1M	2 pieces	41-E

* This Tube cannot be used if a Lens Unit is being used.

Dimensions

Installation Information → 60, 61 Page

Through-beam Fiber Units (Set of 2)

41-A E32-T22B 2M (Free Cutting)

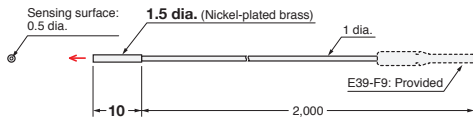

41-D E32-T25XB 2M (Free Cutting)

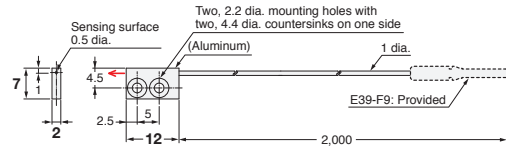

Note 1: Set of two symmetrically shaped Fiber Units.
Note 2: Four, M2 x 8 stainless steel countersunk mounting screws are provided.

41-B E32-T21 2M (Free Cutting)

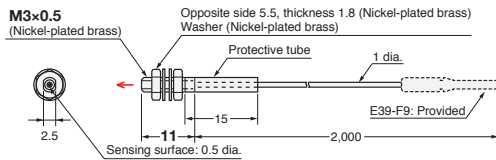

41-E E39-F32C 1M

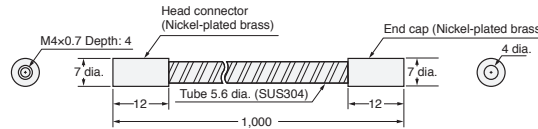

41-C E32-T11 2M (Free Cutting)

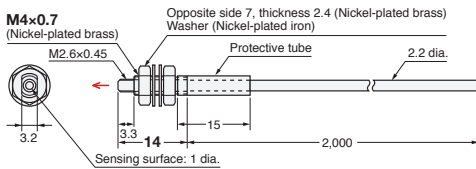

Fiber Sensor Features	
Selection Guide	
Fiber Units	
Threaded	Standard Installation
Cylindrical	
Flat	Saving Space
Sleeved	
Small Spot	Beam Improvements
High Power	
Narrow view	Transparent Objects
BGS	
Retro-reflective	Environmental Immunity
Limited-reflective	
Chemical-resistant, Oil-resistant	Applications
Bending	
Heat-resistant	Installation Information
Area Detection	
Liquid-level	Fiber Amplifiers, Communications Unit, and Accessories
Vacuum	
FPD, Semi, Solar	Technical Guide and Precautions
Model Index	

Fiber Sensor Features

Selection Guide

Fiber Units

Standard Installation

Saving Space

Beam Improvements

Transparent Objects

Environmental Immunity

Applications

Installation Information

Fiber Amplifiers, Communications Unit, and Accessories

Technical Guide and Precautions

Model Index

Threaded

Cylindrical

Flat

Sleeved

Small Spot

High Power

Narrow view

BGS

Retro-reflective

Limited-reflective

Chemical-resistant, Oil-resistant

Bending

Heat-resistant

Area Detection

Liquid-level

Vacuum

FPD, Semi, Solar

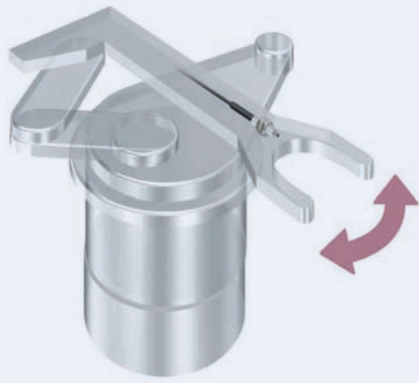

- Capable of withstanding one million repeated bends.

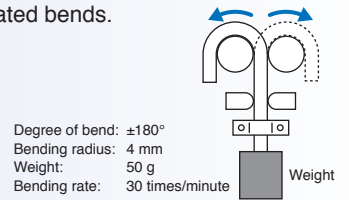

- A large number of independent fine fibers ensures good flexibility. Suitable for use on moving parts without easily breaking.



- Protective Stainless Spiral Tube is available for covering the fiber cable to protect it from accidental breaking due to snagging or shock.

Specifications

Reflective Fiber Units

Size	Appearance (mm)	Bending radius of cable	Sensing distance (mm)				Optical axis diameter (minimum sensing object)	Models	43 Page Dimensions No.
			E3X-HD		E3NX-FA <i>NEW</i>				
			GIGA	HS	Other modes	GIGA			
1.5 dia.		Bendresistant, R4	140	ST : 60	210	ST : 90	(5 μm dia./ 2 μm dia.)	E32-D22B 2M	43-A
M3			40	SHS : 16	60	SHS : 16			
3 dia.			300	ST : 140	450	ST : 210		E32-D221B 2M	43-C
M4			90	SHS : 40	130	SHS : 40		E32-D21B 2M	43-D
M6			840	ST : 350	1,260	ST : 520		E32-D11 2M	43-E
Square			240	SHS : 100	360	SHS : 100			
			240	ST : 100	360	ST : 150	E32-D25XB 2M	43-F	
			60	SHS : 30	90	SHS : 30			

Note The following mode names and response times apply to the modes given in the Sensing distance column.
 1. [E3X-HD] GIGA: Giga-power mode (16 ms), HS: High-speed mode (250 μs), ST: Standard mode (1 ms), and SHS: Super-high-speed mode (NPN output: 50 μs, PNP output: 55 μs)
 [E3NX-FA] GIGA: Giga-power mode (16 ms), HS: High-speed mode (250 μs), ST: Standard mode (1 ms), and SHS: Super-high-speed mode (30 μs)
 The values for the minimum sensing object are reference values that indicate values obtained in standard mode with the sensing distance and sensitivity set to the optimum values.
 2. The first value is for the E3X-HD and the second value is for the E3NX-FA.
 The sensing distances for Reflective Fiber Units are for white paper.

Protective Stainless Spiral Tube (Sold separately)

Insert the fiber cable into the protective tube to prevent breaking by snagging or shock.

Applicable Fiber Units	Models	Quantity	43 Page Dimensions No.
E32-D21R 2M/E32-C31 2M/ E32-D21 2M	E30-F32A 1M	1 piece	43-G
E32-D211R 2M/E32-D21B 2M	E30-F32C 1M	2 pieces	
E32-D11R 2M/E32-CC200 2M/ E32-D11 2M/E32-D51R 2M/ E32-D51 2M	E30-F32D 1M	1 piece	

* This Tube cannot be used if a Lens Unit is being used.

Dimensions

Installation Information → 58, 59 and 61 Page

Limited-reflective Fiber Units

43-A E32-D22B 2M (No Cutting)

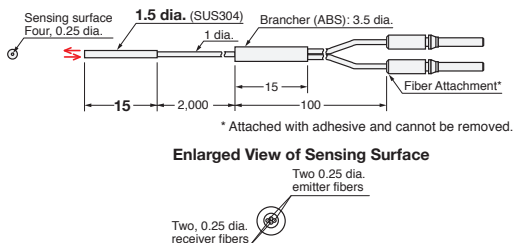

43-B E32-D21 2M (Free Cutting)

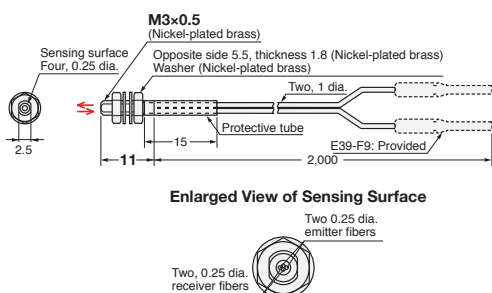

43-C E32-D221B 2M (Free Cutting)

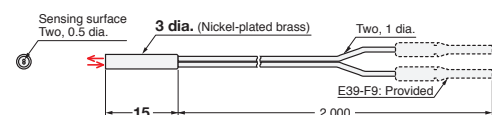

43-D E32-D21B 2M (Free Cutting)

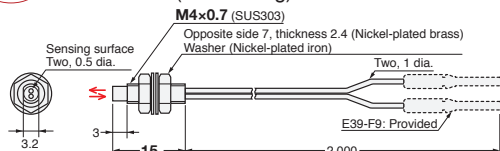

43-E E32-D11 2M (Free Cutting)

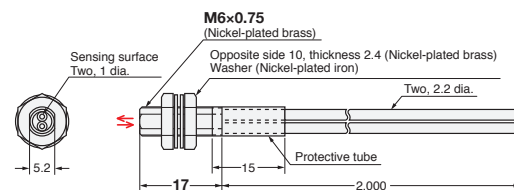

43-F E32-D25XB 2M (Free Cutting)

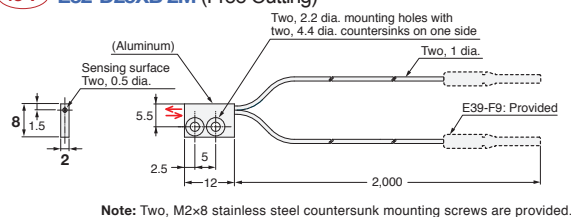

43-G E39-F32A 1M/E39-F32C 1M/E39-F32D 1M

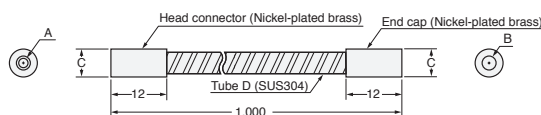

Models	A	B	C	D
E39-F32A 1M	M3x0.5 Depth: 4	3 dia.	6 dia.	(4.6 dia.)
E39-F32C 1M	M4x0.7 Depth: 4	4 dia.	7 dia.	(5.6 dia.)
E39-F32D 1M	M6x0.75 Depth: 4	5 dia.	8.5 dia.	(7 dia.)

Fiber Sensor Features

Selection Guide

Fiber Units

Threaded
Cylindrical

Standard Installation

Flat
Sleeved

Saving Space

Small Spot
High Power

Beam Improvements

Narrow view
BGS

Transparent Objects

Retro-reflective
Limited-reflective

Environmental Immunity

Chemical-resistant,
Oil-resistant

Bending
Heat-resistant

Area Detection

Liquid-level

Vacuum

FPD,
Semi,
Solar

Applications

Installation Information

Fiber Amplifiers,
Communications Unit,
and Accessories

Technical Guide and Precautions

Model Index

Fiber Sensor Features

Selection Guide

Fiber Units

Standard Installation

- Threaded
- Cylindrical

Saving Space

- Flat
- Sleeved

Beam Improvements

- Small Spot
- High Power
- Narrow view
- BGS

Transparent Objects

- Retro-reflective
- Limited-reflective

Environmental Immunity

- Chemical-resistant, Oil-resistant
- Bending
- Heat-resistant

Applications

- Area Detection
- Liquid-level
- Vacuum
- FPD, Semi, Solar

Installation Information

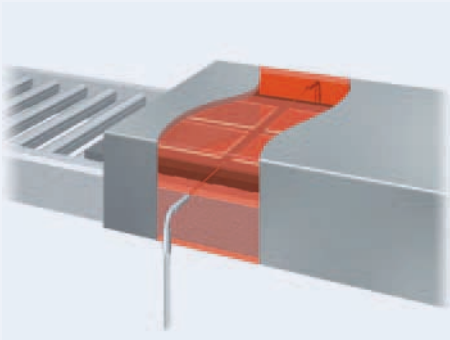

- Wide product variety for temperatures from 100 to 350°C. Select the model according to heat-resistant temperature.

Specifications

Through-beam Fiber Units

Heat-resistant temperature	Appearance (mm)	Bending radius of cable	Sensing distance (mm)				Optical axis diameter (minimum sensing object)	Models	45 Page Dimensions No.
			E3X-HD		E3NX-FA <i>NEW</i>				
			GIGA HS	Other modes	GIGA HS	Other modes			
100°C *1		Flexible, R2	1,600 560	ST : 800 SHS: 225	2,400 840	ST : 1,200 SHS: 225	1 dia. (0.1 dia./0.03 dia.)	E32-T51R 2M	45-A
150°C *2		R35	2,800 1,000	ST : 1,500 SHS: 400	4,000*5 1,500	ST : 2,250 SHS: 400	1.5 dia. (0.1 dia./0.03 dia.)	E32-T51 2M	45-B
200°C *3		R10	1,000 360	ST : 550 SHS: 140	1,500 540	ST : 820 SHS: 140	0.7 dia. (5 µm dia./2 µm dia.)	E32-T81R-S 2M	45-C
350°C *4		R25	1,680 600	ST : 900 SHS: 240	2,520 900	ST : 1,350 SHS: 240	1 dia. (5 µm dia./2 µm dia.)	E32-T61-S 2M	45-D
70°C			—					Standard Fiber Units can be used.	—

*1 For continuous operation, use the Fiber Unit between -40 to 90°C.
 *2 For continuous operation, use the Fiber Unit between -40 to 130°C.
 *3 The heat-resistant rating is not the same for all parts of the Fiber Unit. Refer to the dimensions diagrams for details.
 *4 The ambient operating temperature for the E32-T61-S 2M is -60 to 350°C.
 *5 The optical fiber is 2 m long on each side, so the sensing distance is 4,000 mm.

Note 1. The following mode names and response times apply to the modes given in the Sensing distance column.
 [E3X-HD] GIGA: Giga-power mode (16 ms), HS: High-speed mode (250 µs), ST: Standard mode (1 ms), and SHS: Super-high-speed mode (NPN output: 50 µs, PNP output: 55 µs)
 [E3NX-FA] GIGA: Giga-power mode (16 ms), HS: High-speed mode (250 µs), ST: Standard mode (1 ms), and SHS: Super-high-speed mode (30 µs)
 2. The values for the minimum sensing object are reference values that indicate values obtained in standard mode with the sensing distance and sensitivity set to the optimum values. The first value is for the E3X-HD and the second value is for the E3NX-FA.

Dimensions

Installation Information → 60 Page

Through-beam Fiber Units (Set of 2)

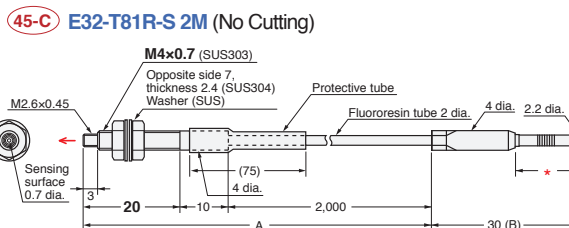
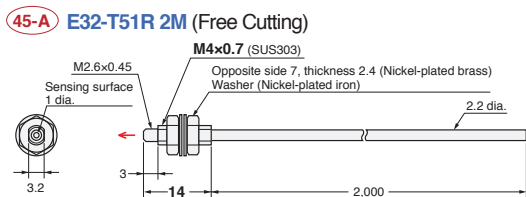

Note: The maximum allowable temperatures for sections A and B are 200°C and 110°C, respectively. The section inserted into the Amplifier Unit (indicated by *) must be maintained within the Amplifier Unit's operating temperature range.

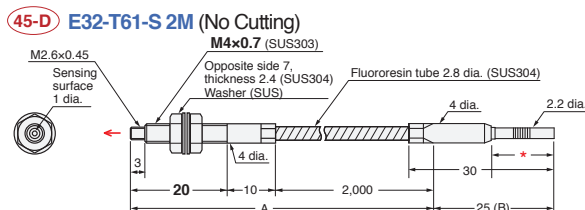
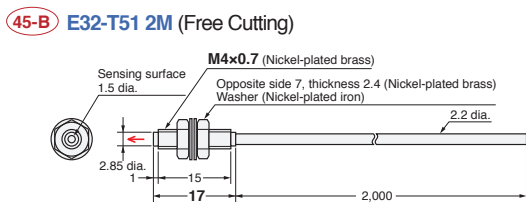

Note: The maximum allowable temperatures for sections A and B are 350°C and 110°C, respectively. The section inserted into the Amplifier Unit (indicated by *) must be maintained within the Amplifier Unit's operating temperature range.

- Reference Information for Model Selection -

And

Long-distance Sensing Applications

A separate Lens Unit can be attached to extend the sensing distance.

→ 28 page

Fiber Sensor Features

Selection Guide

Fiber Units

Threaded	Standard Installation
Cylindrical	
Flat	Saving Space
Sleeved	
Small Spot	Beam Improvements
High Power	
Narrow view	
BGS	
Retro-reflective	Transparent Objects
Limited-reflective	
Chemical-resistant, Oil-resistant	Environmental Immunity
Bending	
Heat-resistant	
Area Detection	
Liquid-level	Applications
Vacuum	
FPD, Semi, Solar	

Installation Information

Fiber Amplifiers, Communications Unit, and Accessories

Technical Guide and Precautions

Model Index

- Threaded
- Cylindrical

- Flat
- Sleeved

- Small Spot
- High Power
- Narrow view
- BGS

- Retro-reflective
- Limited-reflective

- Chemical-resistant, Oil-resistant
- Bending
- Heat-resistant

- Area Detection
- Liquid-level
- Vacuum
- FPD, Semi, Solar

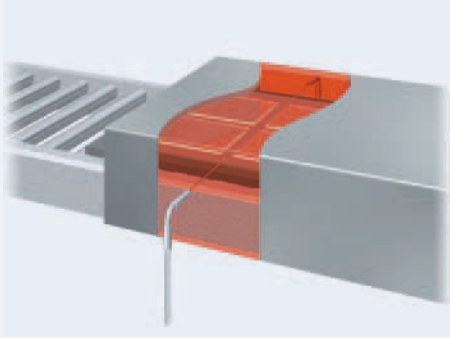

- Wide product variety for temperatures from 100 to 400°C. Select the model according to heat-resistant temperature.

Specifications

Reflective Fiber Units

Heat-resistant temperature	Appearance (mm)	Bending radius of cable	Sensing distance (mm)				Standard sensing object (minimum sensing object)	Models	47 Page Dimensions No.
			E3X-HD		E3NX-FA <i>NEW</i>				
			GIGA	HS	GIGA	HS			
100°C *1		Flexible, R2	670	ST : 280	1,000	ST : 420	5 μm dia./ 2 μm dia.)	E32-D51R 2M	47-A
			190	SHS: 80	280	SHS: 80			
			1,120	ST : 450	1,680	ST : 670			
150°C *2		R35	320	SHS: 144	480	SHS: 144		E32-D51 2M	47-B
200°C *3		R10	420	ST : 180	630	ST : 270		E32-D81R-S 2M	47-C
			120	SHS: 54	180	SHS: 54			
300°C		R25	10 to 20	ST : 10 to 20	10 to 20	ST : 10 to 20	Soda glass with reflection factor of 7%	E32-A08H2 2M	47-D
			10 to 20	SHS: -	10 to 20	SHS: -			
			20 to 30	ST : 20 to 30	20 to 30	ST : 20 to 30	End surface of soda glass with reflection factor of 7% (t = 0.7 mm, rounded edges)	E32-A09H2 2M	47-E
			20 to 30	SHS: -	20 to 30	SHS: -			
350°C *3		R25	420	ST : 180	630	ST : 270	(5 μm dia./ 2 μm dia.)	E32-D611-S 2M	47-F
			120	SHS: 54	180	SHS: 54			
			280	ST : 120	420	ST : 180			
			80	SHS: 36	120	SHS: 36		E32-D73-S 2M	47-H
70°C			—					Standard Fiber Units can be used.	—

*1 For continuous operation, use the Fiber Unit between -40 to 90°C.
 *2 For continuous operation, use the Fiber Unit between -40 to 130°C.
 *3 The heat-resistant rating is not the same for all parts of the Fiber Unit. Refer to the dimensions diagrams for details.

- Note 1.** The following mode names and response times apply to the modes given in the Sensing distance column.
 [E3X-HD] GIGA: Giga-power mode (16 ms), HS: High-speed mode (250 μs), ST: Standard mode (1 ms), and SHS: Super-high-speed mode (NPN output: 50 μs, PNP output: 55 μs)
 [E3NX-FA] GIGA: Giga-power mode (16 ms), HS: High-speed mode (250 μs), ST: Standard mode (1 ms), and SHS: Super-high-speed mode (30 μs)
- 2.** The values for the minimum sensing object are reference values that indicate values obtained in standard mode with the sensing distance and sensitivity set to the optimum values.
 The first value is for the E3X-HD and the second value is for the E3NX-FA.
- 3.** The sensing distances for Reflective Fiber Units are for white paper.

Dimensions

Installation Information → 58, 59 Page

Reflective Fiber Units

47-A E32-D51R 2M (Free Cutting)

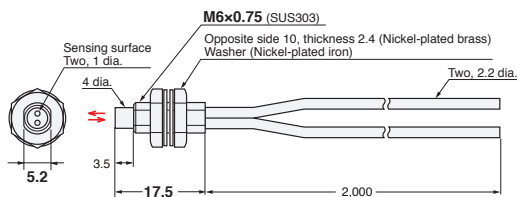

47-B E32-D51 2M (Free Cutting)

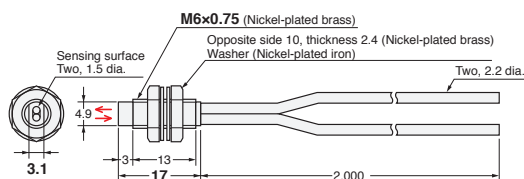

47-C E32-D81R-S 2M (No Cutting)

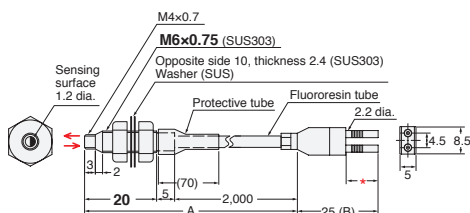

Note: The maximum allowable temperatures for sections A and B are 200°C and 110°C, respectively. The section inserted into the Amplifier Unit (indicated by *) must be maintained within the Amplifier Unit's operating temperature range.

47-D E32-A08H2 2M (No Cutting)

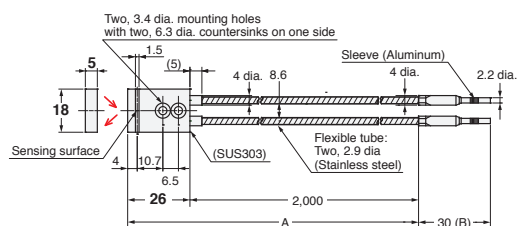

Note: The maximum allowable temperatures for sections A and B are 300°C and 110°C, respectively.



47-E E32-A09H2 2M (No Cutting)

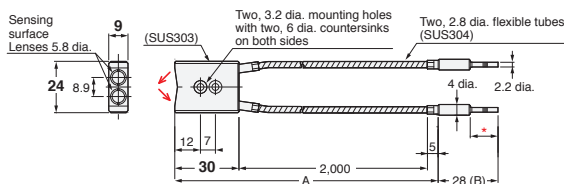

Note: The maximum allowable temperatures for sections A and B are 300°C and 110°C, respectively. The section inserted into the Amplifier Unit (indicated by *) must be maintained within the Amplifier Unit's operating temperature range.

47-F E32-D611-S 2M (No Cutting)

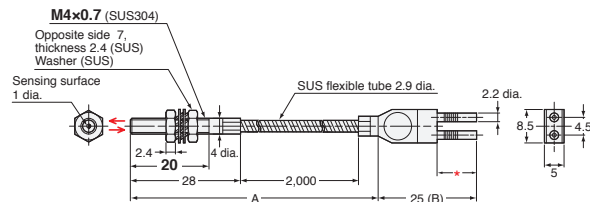

Note: The maximum allowable temperatures for sections A and B are 350°C and 110°C, respectively. The section inserted into the Amplifier Unit (indicated by *) must be maintained within the Amplifier Unit's operating temperature range.

47-G E32-D61-S 2M (No Cutting)

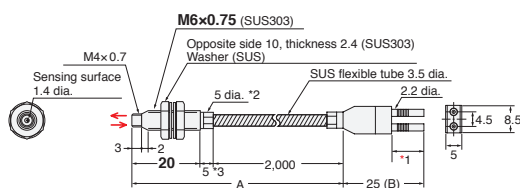

- *2. The diameter is 6 dia. if the fiber length exceeds 10 m.
- *3. The length is 10 if the fiber length exceeds 10 m.

Note: The maximum allowable temperatures for sections A and B are 350°C and 110°C, respectively. The section inserted into the Amplifier Unit (indicated by *) must be maintained within the Amplifier Unit's operating temperature range.

47-H E32-D73-S 2M (No Cutting)

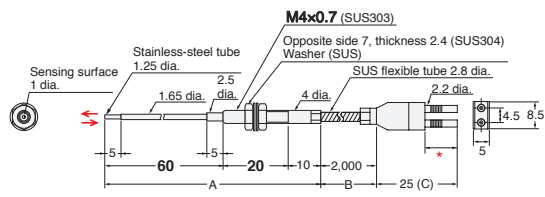

Note: The maximum allowable temperatures for sections A, B, and C are 400°C, 300°C, and 110°C, respectively. The section inserted into the Amplifier Unit (indicated by *) must be maintained within the Amplifier Unit's operating temperature range.

Fiber Sensor
Features

Selection
Guide

Fiber Units

Threaded

Cylindrical

Flat

Sleeved

Small Spot

High Power

Narrow
view

BGS

Retro-
reflective

Limited-
reflective

Chemical-
resistant,
Oil-resistant

Bending

Heat-
resistant

Area
Detection

Liquid-level

Vacuum

FPD,
Semi,
Solar

Installation
Information

Fiber Amplifiers,
Communications
Unit, and
Accessories

Technical
Guide and
Precautions

Model Index

Fiber Sensor Features

Selection Guide

Fiber Units

Standard Installation

- Threaded
- Cylindrical

Saving Space

- Flat
- Sleeved

Beam Improvements

- Small Spot
- High Power
- Narrow view
- BGS

Transparent Objects

- Retro-reflective
- Limited-reflective

Environmental Immunity

- Chemical-resistant, Oil-resistant
- Bending
- Heat-resistant

Applications

- Area Detection
- Liquid-level
- Vacuum
- FPD, Semi, Solar

Installation Information

Fiber Amplifiers, Communications Unit, and Accessories

Technical Guide and Precautions

Model Index

Detection of falling workpieces



Meander detection

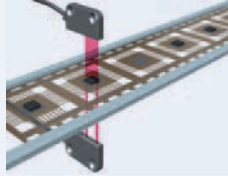

Detection of workpieces with holes

• Area beams are optimum for detecting workpieces presented in inconsistent positions, such as falling workpieces, or for meander detection, or for detecting workpieces with holes.

• This Fiber Unit is ideal for meander detectin because it outputs the digital value in a linear relation to the interrupted light distance.

Characteristics of Light Interruption (Reference Value)

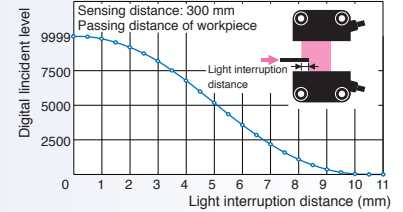

E32-T16PR+E3NX-FA21

Specifications

Through-beam Fiber Units

Type	Sensing width	Appearance (mm)	Bending radius of cable	Sensing distance (mm)				Optical axis diameter (minimum sensing object)	Models	49 Page Dimensions No.
				E3X-HD		E3NX-FA <i>NEW</i>				
				GIGA	HS	Other modes	GIGA			
Area	11 mm		Flexible, R1	3,100		4,000 *1		*2 (0.2 dia./0.07 dia.)	E32-T16PR 2M	49-A
				ST : 1,700	ST : 2,550					
				SHS: 440	SHS: 440					
	2,750			4,000 *1		*2 (0.3 dia./0.1 dia.)	E32-T16JR 2M		49-B	
	ST : 1,500	ST : 2,250								
	SHS: 380	SHS: 380								
4,000 *1		4,000 *1		*2 (0.3 dia./0.1 dia.)	E32-T16WR 2M	49-C				
ST : 2,600	ST : 3,900									
SHS: 680	SHS: 680									
30 mm		1,120		1,680		*2 (0.3 dia./0.1 dia.)	E32-T16PR 2M	49-A		
		ST : 1,700	ST : 2,550							
		SHS: 440	SHS: 440							

*1 The optical fiber is 2 m long on each side, so the sensing distance is 4,000 mm.
 *2 The values for the minimum sensing object were obtained for detection in the sensing area with the sensing distance set to 300 mm. (The values are for a stationary sensing object.)
 The first value is for the E3X-HD and the second value is for the E3NX-FA.

Reflective Fiber Units

Type	Sensing width	Appearance (mm)	Bending radius of cable	Sensing distance (mm)				Optical axis diameter (minimum sensing object)	Model	49 Page Dimensions No.
				E3X-HD		E3NX-FA <i>NEW</i>				
				GIGA	HS	Other modes	GIGA			
Array	11 mm		Bend-resistant, R4	700	ST : 300	1,050	ST : 450	(5 μm dia./2 μm dia.)	E32-D36P1 2M	49-D
				200	SHS: 90	300	SHS: 90			

Note 1. The following mode names and response times apply to the modes given in the Sensing distance column.
 [E3X-HD] GIGA: Giga-power mode (16 ms), HS: High-speed mode (250 μs), ST: Standard mode (1 ms), and SHS: Super-high-speed mode (NPN output: 50 μs, PNP output: 55 μs)
 [E3NX-FA] GIGA: Giga-power mode (16 ms), HS: High-speed mode (250 μs), ST: Standard mode (1 ms), and SHS: Super-high-speed mode (30 μs)
 2. The values for the minimum sensing object are reference values that indicate values obtained in standard mode with the sensing distance and sensitivity set to the optimum values. The first value is for the E3X-HD and the second value is for the E3NX-FA.

Dimensions

Installation Information → 60 Page

Installation Information → 59 Page

Through-beam Fiber Units (Set of 2)

Through-beam Fiber Units (Set of 2)

49-A E32-T16PR 2M (Free Cutting)

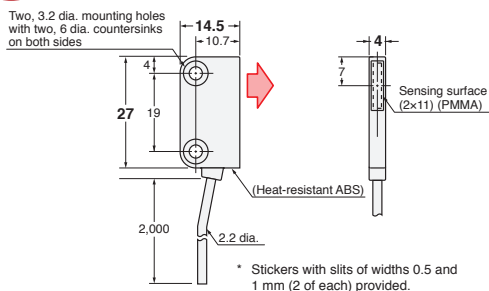

49-B E32-T16JR 2M (Free Cutting)

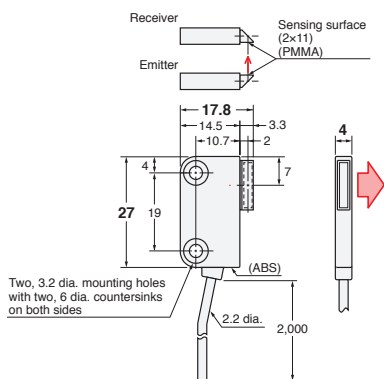

49-C E32-T16WR 2M (Free Cutting)

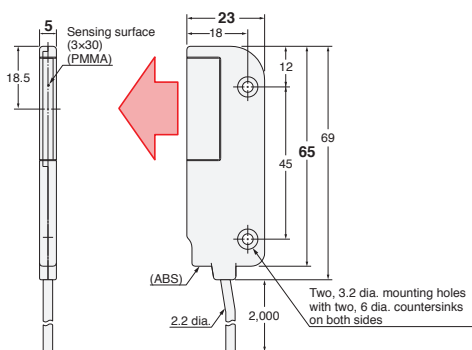

49-D E32-D36P1 2M (Free Cutting)

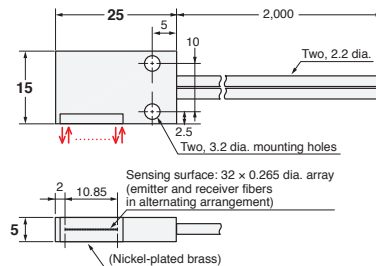

Fiber Sensor Features

Selection Guide

Fiber Units

Threaded	Standard Installation
Cylindrical	
Flat	Saving Space
Sleeved	
Small Spot	Beam Improvements
High Power	
Narrow view	
BGS	Transparent Objects
Retro-reflective	
Limited-reflective	
Chemical-resistant, Oil-resistant	Environmental Immunity
Bending	
Heat-resistant	
Area Detection	Applications
Liquid-level	
Vacuum	
FPD, Semi, Solar	Installation Information

Fiber Amplifiers, Communications Unit, and Accessories

Technical Guide and Precautions

Model Index

Threaded
Cylindrical

Flat

Sleeved

Small Spot

High Power

Narrow view

BGS

Retro-reflective

Limited-reflective

Chemical-resistant, Oil-resistant

Bending

Heat-resistant

Area Detection

Liquid-level

Vacuum

FPD, Semi, Solar



• Fiber Units for detecting liquid levels are available in two types: for tube mounting and liquid contact.

▶ **Tube-mounting Types**

Detect the liquid level inside transparent tubes. Strap the Fiber Unit to a tube with band.



▶ **Liquid-contact Type**

Detect the liquid level by direct contact with the liquid. This model has excellent chemical-resistance because the Fiber Unit is covered in fluororesin.

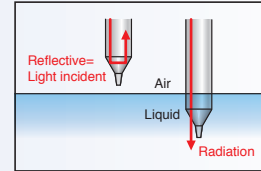

Specifications

Detection scheme	Tube diameter	Features	Appearance (mm)	Bending radius of cable	Applicable range	Optical axis diameter (minimum sensing object)	Models	51 Page Dimensions No.
Tube-mounting	3.2, 6.4 and 9.5 dia.	<ul style="list-style-type: none"> Resistant to bubbles and droplets Residual quantity detection 	 IP50	Bend-resistant, R4	Applicable tube: Transparent tube with a diameter of 3.2, 6.4, or 9.5 dia. and a recommended wall thickness of 1 mm	—	E32-A01 5M	51-A
	8 to 10 dia.	Ideal for mounting at multilevels	 IP50	R10	Applicable tube: Transparent tube with a diameter of 8 to 10 dia. and a recommended wall thickness of 1 mm	—	E32-L25T 2M	51-B
	No restrictions	<ul style="list-style-type: none"> Usable on large diameter tubes Resistant to bubbles and droplets 	 IP67	R4	Applicable tube: Transparent tube (no restrictions on diameter)	—	E32-D36T 2M	51-C
Liquid contact (heat-resistant up to 200°C)	—	—	 IP68	R40 R25 *3	Liquid-contact Type *1	—	E32-D82F1 4M	51-D

*1 If the incident light level is too high, perform power tuning or use the ECO mode to decrease the incident level.

*2 The applicable range is the same whether an E3X-HD series or E3NX-FA series is used.

When using a Fiber Amplifier Unit in giga-power mode, level detection may not work depending on the tube diameter. Make sure to confirm operation with the actual tube.

*3 The bending radius of the sensing section (except for the unbendable section) is 40 mm, and the bending radius of the fiber is 25 mm.

- Reference Information for Model Selection -

Determining the Best Model for Tube-mounted Types

Mounting and conditions	Recommended Unit	Features
When bubbles and the water droplets are generated	E32-A01	This is a Through-beam Model, so the incident light will differ greatly between with and without of liquid. It also uses an area beam, which is less prone to false detection by bubbles and droplets.
Multilevel installation in limited space	E32-L25T	This model is suitable for mounting at multilevels because of the thin type (height: 10 mm).
Mounting on large diameter tubes	E32-D36T	This model has no restrictions on the tube diameter, so it can be mounted on many different tube sizes. It also uses an area beam, which is less prone to false detection by bubbles and droplets.

Dimensions

Installation Information → 58, 59 Page

51-A E32-A01 5M (Free Cutting)

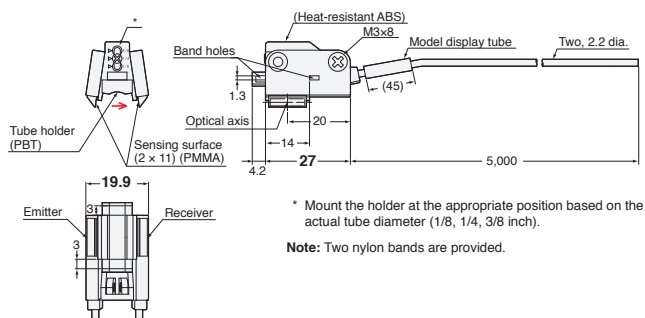

Tube-mounting Examples



51-B E32-L25T 2M (Free Cutting)

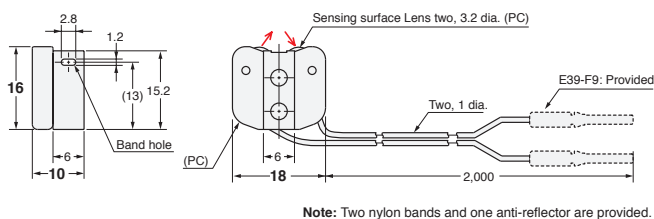

51-C E32-D36T 2M (Free Cutting)

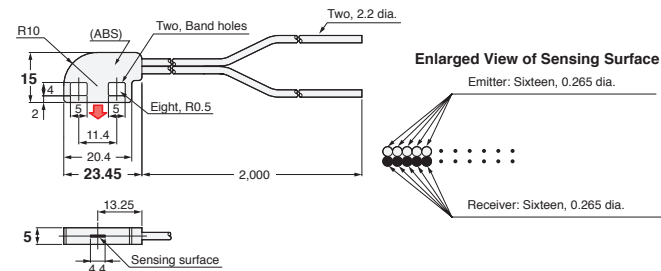

51-D E32-D82F1 4M (Free Cutting)

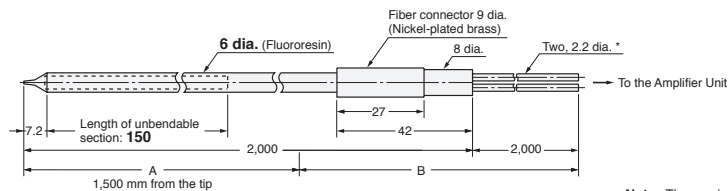

* The 2-m section of optical fiber on the Amplifier unit side is plastic and therefore allows free cutting.

Note: The maximum allowable temperature is 200°C for section A and 85°C for section B.

And

Designed for Safe Residual quantity detection (E32-A01 only)

The E32-A01 Fiber Unit is designed to default to the same output as for liquid absent in the event of a failure, such as when the fiber breaks. This makes it suitable for residual quantity detection.

Trouble (disconnection)	Light interrupted
With liquid	Light interrupted
Without liquid	Light incident

If the failure goes unnoticed, this failsafe design will prevent false detection of liquid when there is no liquid present.

Fiber Sensor Features

Selection Guide

Fiber Units

Threaded

Cylindrical

Flat

Sleeved

Small Spot

High Power

Narrow view

BGS

Retro-reflective

Limited-reflective

Chemical-resistant, Oil-resistant

Bending

Heat-resistant

Area Detection

Liquid-level

Vacuum

FPD, Semi, Solar

Installation Information

Fiber Amplifiers, Communications Unit, and Accessories

Technical Guide and Precautions

Model Index

- Threaded
- Cylindrical

- Flat
- Sleeved

- Small Spot
- High Power
- Narrow view
- BGS

- Retro-reflective
- Limited-reflective

- Chemical-resistant, Oil-resistant
- Bending
- Heat-resistant

- Area Detection
- Liquid-level
- Vacuum
- FPD, Semi, Solar

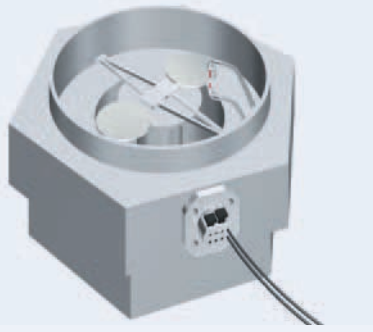

- Can be used under high vacuums of up to 10⁻⁵ Pa.
- Available in models with heat resistant up to 120 or 200°C.

Configuration Example for using under vacuum

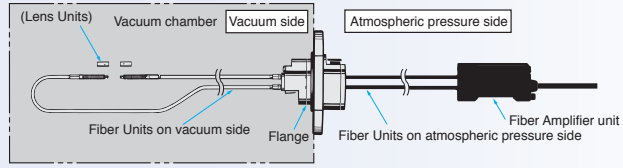

Specifications

Through-beam Fiber Units

Type	Heat-resistant temperature	Appearance (mm)	Bending radius of cable	Sensing distance (mm)				Optical axis diameter (minimum sensing object)	Models	53 Page Dimensions No.
				E3X-HD		E3NX-FA <i>NEW</i>				
				GIGA	HS	Other modes	GIGA			
Vacuum side	120°C		R30	720	ST : 400	1,080	ST : 600	1.2 dia. (10 μm dia./ 4 μm dia.)	E32-T51V 1M	53-A
				260	SHS: 100	390	SHS: 100			
Vacuum side	200°C		R30	2,000*	ST : 2,000	2,000*	ST : 2,000	4 dia. (0.1 dia./ 0.03 dia.)	E32-T51V 1M + E39-F1V	53-B
				1,360	SHS: 520	2,000*	SHS: 520			
Atmospheric pressure side	70°C		R25	1,760	ST : 950	2,000*	ST : 1,420	2 dia. (0.1 dia./ 0.03 dia.)	E32-T84SV 1M	53-C
				640	SHS: 260	960	SHS: 260			
Atmospheric pressure side	70°C			—	ST : -	—	ST : -	—	E32-T10V 2M	53-D

* The optical fiber is 2 m long on each side, so the sensing distance is 4,000 mm.

Note 1. The following mode names and response times apply to the modes given in the Sensing distance column.

[E3X-HD] GIGA: Giga-power mode (16 ms), HS: High-speed mode (250 μs), ST: Standard mode (1 ms), and SHS: Super-high-speed mode (NPN output: 50 μs, PNP output: 55 μs)
[E3NX-FA] GIGA: Giga-power mode (16 ms), HS: High-speed mode (250 μs), ST: Standard mode (1 ms), and SHS: Super-high-speed mode (30 μs)

2. The values for the minimum sensing object are reference values that indicate values obtained in standard mode with the sensing distance and sensitivity set to the optimum values. The first value is for the E3X-HD and the second value is for the E3NX-FA.

Flange

Appearance	Type	Models	53 Page Dimensions No.
	4-channel flange	E32-VF4	53-E
	1-channel flange	E32-VF1	53-F

Dimensions

Installation Information → 60, 61 Page

Through-beam Fiber Units (Set of 2)

53-A E32-T51V 1M (No Cutting)

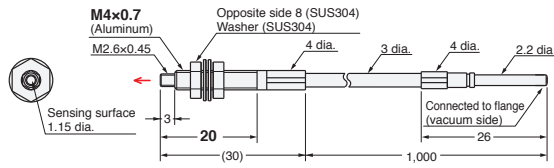

53-B E32-T51V 1M (No Cutting) + E39-F1V

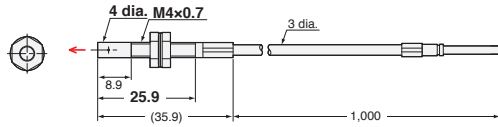

E39-F1V

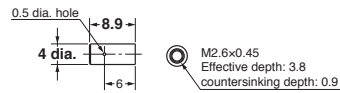

53-C E32-T84SV 1M (No Cutting)

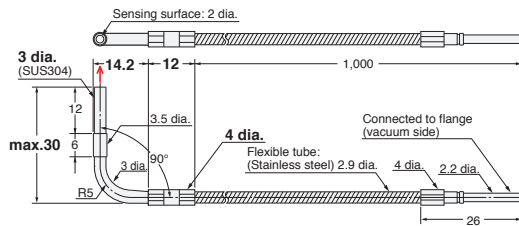

53-D E32-T10V 2M (Free Cutting)

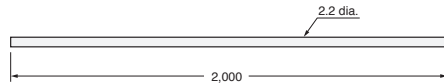

53-E E32-VF4

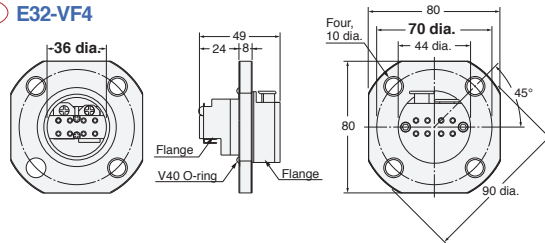

- Note 1. Mount the Flange so that the V40 O-ring is on the atmospheric-pressure side of the vacuum chamber wall.
 2. Mounting-hole dimensions: 38 dia. ±0.5 mm
 3. The maximum tightening torque is 9.8 N·m.
 4. A V40 O-ring is provided.

53-F E32-VF1

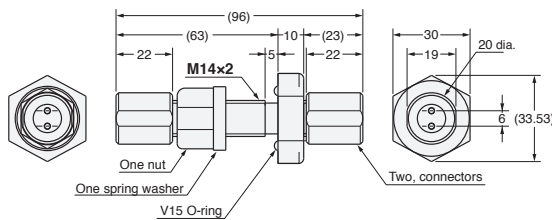

- Note 1. Mount the Flange so that the V15 O-ring is on the atmospheric-pressure side of the vacuum chamber wall.
 2. Mounting-hole dimensions: 14.5 dia. ±0.2 mm
 3. The maximum tightening torque is 14.7 N·m for the clamp nut and 1.5 N·m for the connector.
 4. A V15 O-ring, nut, spring washer, two connectors, and four O-rings for the fibers are provided.

- Reference Information for Model Selection -

What Is a Vacuum-resistant Fiber Unit?

- The Flange is designed to create an air-tight seal on the vacuum side.
- The fibers and Flange on the vacuum side are made of non-outgassing materials. These parts are inspected, cleaned, and sealed in an air-tight package in a clean room prior to shipment.

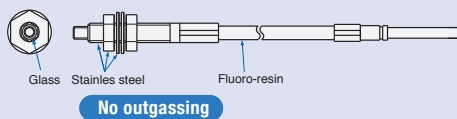

Fiber Sensor Features

Selection Guide

Fiber Units

Threaded

Cylindrical

Flat

Sleeved

Small Spot

High Power

Narrow view

BGS

Retro-reflective

Limited-reflective

Chemical-resistant, Oil-resistant

Bending

Heat-resistant

Area Detection

Liquid-level

Vacuum

FPD, Semi, Solar

Installation Information

Fiber Amplifiers, Communications Unit, and Accessories

Technical Guide and Precautions

Model Index

Threaded

Cylindrical

Flat

Sleeved

Small Spot

High Power

Narrow view

BGS

Retro-reflective

Limited-reflective

Chemical-resistant, Oil-resistant

Bending

Heat-resistant

Area Detection

Liquid-level

Vacuum

FPD, Semi, Solar

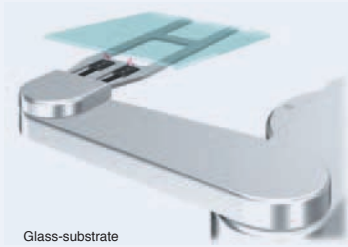

Glass-substrate Alignment

Glass-substrate Alignment

- Detection position accuracy: 0.2 mm max. No variation in detection positions even if the sensing distance changes.
- Tilting workpiece does not affect detection.

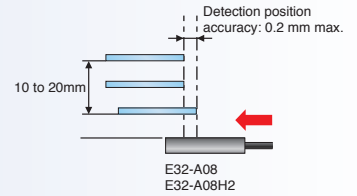

Glass-substrate Mapping

Stable detection is possible even for difficult-to-detect curved surfaces.

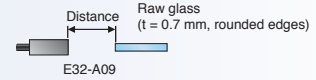
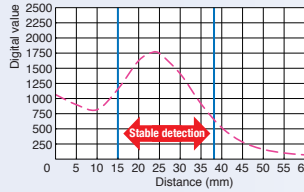

Glass Presence Detection in Wet Processes

- Stable non-contact detection even with warped glass.
- The spherical heads ensure stable detection without being influenced by liquid.

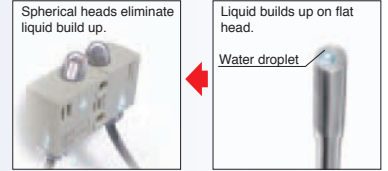

Specifications

Limited-reflective Fiber Units

Application	Ambient temperature	Appearance (mm)	Bending radius of cable	Sensing distance (mm)				Standard sensing object (minimum sensing object)	Models	55 Page Dimensions No.
				E3X-HD		E3NX-FA <i>NEW</i>				
				GIGA = HS	Other modes	GIGA = HS	Other modes			
Glass presence detection	70°C		R25	0 to 15	ST : 0 to 15	0 to 15	ST : 0 to 15	Soda glass with reflection factor of 7%	E32-L16-N 2M *1	55-A
				0 to 15	SHS : 0 to 12	0 to 15	SHS : 0 to 12			
Glass-substrate Alignment	300°C		R25	10 to 20	ST : 10 to 20	10 to 20	ST : 10 to 20	Soda glass with reflection factor of 7%	E32-A08 2M *1	55-B
				10 to 20	SHS : -	10 to 20	SHS : -			
Glass-substrate Alignment	70°C		R25	12 to 30	ST : 12 to 30	12 to 30	ST : 12 to 30	Soda glass with reflection factor of 7%	E32-A08H2 2M *1	55-C
				12 to 30	SHS : -	12 to 30	SHS : -			
Mapping of glass substrates	70°C		R25	15 to 38	ST : 15 to 38	15 to 38	ST : 15 to 38	End surface of soda glass with reflection factor of 7% (t = 0.7 mm, rounded edges)	E32-A12 2M	55-D
				15 to 38 (Center 25)	SHS : - (Center 25)	15 to 38 (Center 25)	SHS : - (Center 25)			
Mapping of glass substrates	300°C *2		R25	20 to 30	ST : 20 to 30	20 to 30	ST : 20 to 30	End surface of soda glass with reflection factor of 7% (t = 0.7 mm, rounded edges)	E32-A09 2M	55-E
				20 to 30 (Center 25)	SHS : - (Center 25)	20 to 30 (Center 25)	SHS : - (Center 25)			
Wet processes (Cleaning, Resist developing, and etching)	60°C		R40	8 to 20 mm from tip of lens (Recommended sensing distance: 11 mm) 19 to 31 mm from center of mounting hole A (Recommended sensing distance: 22 mm)				Glass (t=0.7mm)	E32-A09H2 2M	55-F
Wet processes (Resist stripping)	85°C			8 to 20 mm from tip of lens (Recommended sensing distance: 11 mm) 32 to 44 mm from center of mounting hole A (Recommended sensing distance: 35 mm)					E32-L11FP 2M	55-G
Wet processes (Resist stripping)	85°C		R40	8 to 20 mm from tip of lens (Recommended sensing distance: 11 mm) 32 to 44 mm from center of mounting hole A (Recommended sensing distance: 35 mm)				Glass (t=0.7mm)	E32-L11FS 2M	55-H

*1 If operation is affected by the background, perform power tuning to decrease the incident light level.
*2 The maximum allowable temperature is not the same for all parts of the Fiber Unit. Refer to the dimensions diagrams for details. Must not be repeatedly subject to rapid temperature changes.

Note 1. The following mode names and response times apply to the modes given in the Sensing distance column.
[E3X-HD] GIGA: Giga-power mode (16 ms), HS: High-speed mode (250 μs), ST: Standard mode (1 ms), and SHS: Super-high-speed mode (NPN output: 50 μs, PNP output: 55 μs)
[E3NX-FA] GIGA: Giga-power mode (16 ms), HS: High-speed mode (250 μs), ST: Standard mode (1 ms), and SHS: Super-high-speed mode (30 μs)

Dimensions

Installation Information → 58, 59 Page

Limited-reflective Fiber Units

55-A E32-L16-N 2M (Free Cutting)

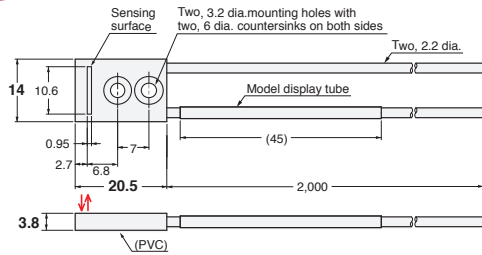

55-B E32-A08 2M (Free Cutting)

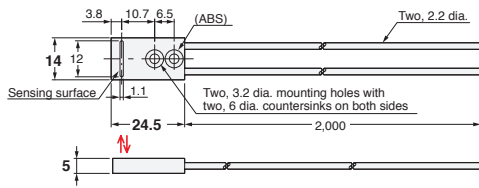

55-C E32-A08H2 2M (No Cutting)

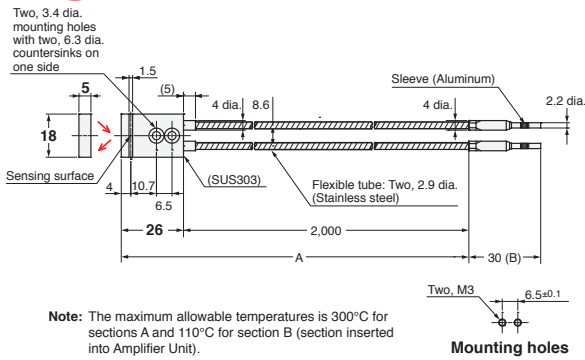

55-D E32-A12 2M (Free Cutting)

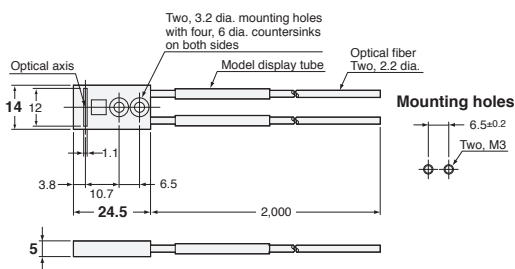

55-E E32-A09 2M (Free Cutting)

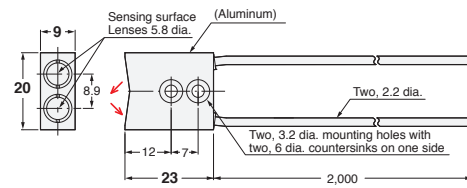

55-F E32-A09H2 2M (No Cutting)

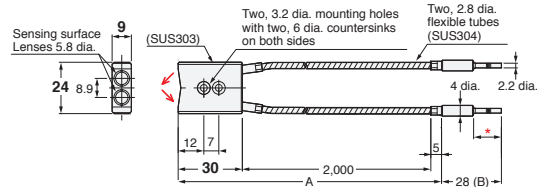

Note: The maximum allowable temperatures for sections A and B are 300°C and 110°C, respectively. The section inserted into the Amplifier Unit (indicated by *) must be maintained within the Amplifier Unit's operating temperature range.

55-G E32-L11FP 2M (Free Cutting)

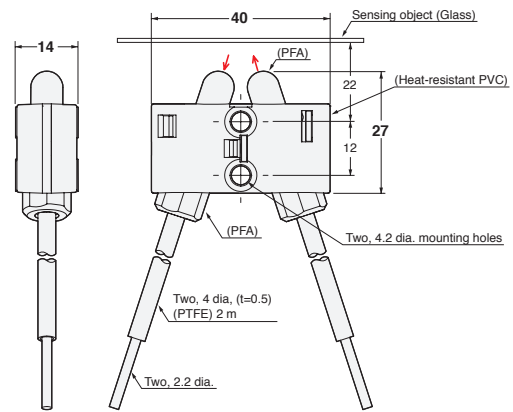

55-H E32-L11FS 2M (Free Cutting)

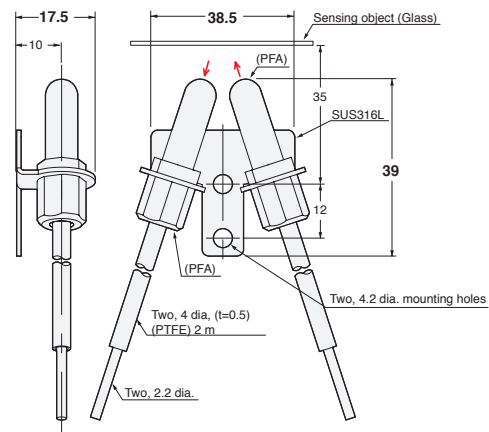

Fiber Sensor Features

Selection Guide

Fiber Units

Threaded

Cylindrical

Flat

Sleeved

Small Spot

High Power

Narrow view

BGS

Retro-reflective

Limited-reflective

Chemical-resistant, Oil-resistant

Bending

Heat-resistant

Area Detection

Liquid-level

Vacuum

FPD, Semi, Solar

Installation Information

Fiber Amplifiers, Communications Unit, and Accessories

Technical Guide and Precautions

Model Index

Fiber Sensor Features

Selection Guide

Fiber Units

Standard Installation

Saving Space

Beam Improvements

Transparent Objects

Environmental Immunity

Applications

Installation Information

Fiber Amplifiers, Communications Unit, and Accessories

Technical Guide and Precautions

Model Index

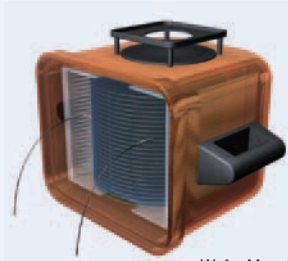

Wafer Mapping

• Wafer Mapping

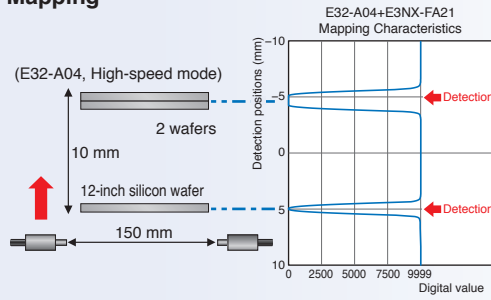

- ▶ Thin-profile design enables easy mounting on robot arms.
- ▶ Easy to adjust optical axis.
(Typical alignment error between mechanical and optical axes is only $\pm 0.1^\circ$.)
- ▶ Reliably wafer detection, even when stacked closely together.

Specifications

Through-beam Fiber Units

Application	Ambient temperature	Aperture angle	Appearance (mm)	Bending radius of cable	Sensing distance (mm)				Optical axis diameter (minimum sensing object)	Models	57 Page Dimensions No.
					E3X-HD		E3NX-FA <i>NEW</i>				
					GIGA	HS	Other modes	GIGA			
Wafer Mapping	70°C	1.5°	 Thickness: 3 mm IP50	Flexible, R1	4,000 *			4,000 *	2 dia. (0.1 dia./0.03 dia.)	E32-A03 2M	57-A
					3,220	ST : 1,780		2,670			
		3.4°	 Thickness: 3 mm IP50	R10	1,200			1,800	1.2 dia. (0.1 dia./0.03 dia.)	E32-A03-1 2M	57-B
					1,280	ST : 680		1,020			
		4°	 Thickness: 2 mm IP50	Flexible, R1	4,000 *			4,000 *	2 dia. (0.1 dia./0.03 dia.)	E32-T24SR 2M	57-D
					1,460	ST : 2,200		3,300			
4°	 3.5 dia. IP50	R10	4,000 *			4,000 *	2 dia. (0.1 dia./0.03 dia.)	E32-T24S 2M	57-E		
			1,740	ST : 2,600		3,900					

* The optical fiber is 2 m long on each side, so the sensing distance is 4,000 mm.

Note 1. The following mode names and response times apply to the modes given in the Sensing distance column.

[E3X-HD] GIGA: Giga-power mode (16 ms), HS: High-speed mode (250 μ s), ST: Standard mode (1 ms), and SHS: Super-high-speed mode (NPN output: 50 μ s, PNP output: 55 μ s)

[E3NX-FA] GIGA: Giga-power mode (16 ms), HS: High-speed mode (250 μ s), ST: Standard mode (1 ms), and SHS: Super-high-speed mode (30 μ s)

2. The values for the minimum sensing object are reference values that indicate values obtained in standard mode with the sensing distance and sensitivity set to the optimum values.

The first value is for the E3X-HD and the second value is for the E3NX-FA.

Dimensions

Installation Information → 58, 60 Page

Through-beam Fiber Units (Set of 2)

57-A E32-A03 2M (Free Cutting)

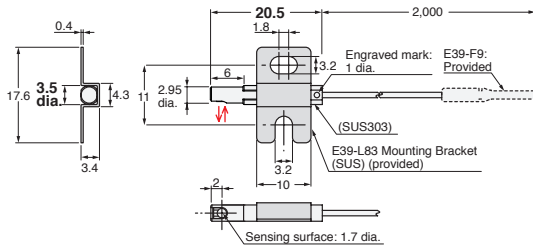

Note: Use the engraved surface and its opposing surface as installation (reference) surfaces.

57-B E32-A03-1 2M (Free Cutting)

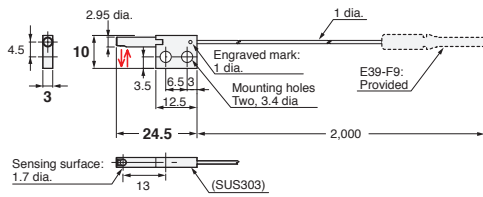

Note1: Use the engraved surface and its opposing surface as installation (reference) surfaces.
2. Set of two symmetrical parts.

57-C E32-A04 2M (Free Cutting)

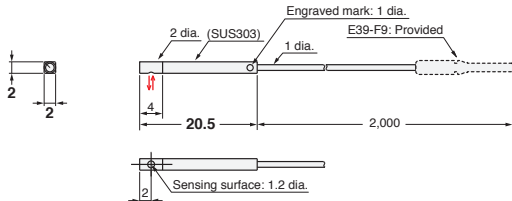

Note: Use the engraved surface and its opposing surface as installation (reference) surfaces.

57-D E32-T24SR 2M (Free Cutting)

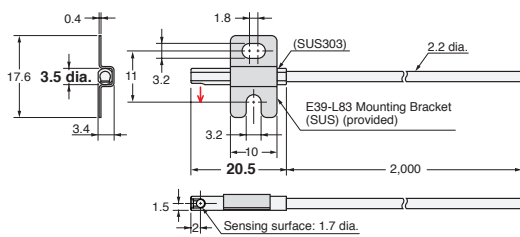

57-E E32-T24S 2M (Free Cutting)

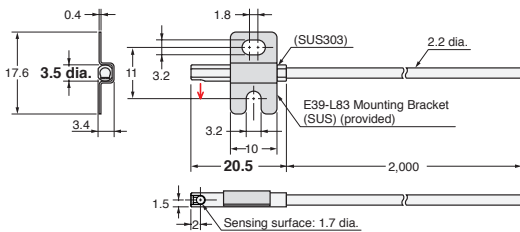

Fiber Sensor Features

Selection Guide

Fiber Units

Threaded

Cylindrical

Flat

Sleeved

Small Spot

High Power

Narrow view

BGS

Retro-reflective

Limited-reflective

Chemical-resistant, Oil-resistant

Bending

Heat-resistant

Area Detection

Liquid-level

Vacuum

FPD, Semi, Solar

Installation Information

Fiber Amplifiers, Communications Unit, and Accessories

Technical Guide and Precautions

Model Index

Models	Installation			Cable						Weight (packed state) (g)	Dimensions Page No.
	Ambient temperature	Tightening torque	Mounting hole	Bending radius	Unbendable length*1	Tensile strength	Sheath material	Core material	Emitter/receiver differentiation		
E32-A01 5M	-40 to 70°C	0.03N·m	–	R4	10	9.8N	Fluororesin	Plastic	None	200	51 Page (51-A)
E32-A03 2M	-40 to 70°C	0.29N·m	–	R1	0	9.8N	Polyethylene	Plastic	None	40	31 Page (31-A) 57 Page (57-A)
E32-A03-1 2M	-40 to 70°C	0.29N·m	–	R10	10	9.8N	Polyethylene	Plastic	None	50	31 Page (31-B) 57 Page (57-B)
E32-A04 2M	-40 to 70°C	0.29N·m	2.2 ^{+0.5} / ₀ dia.	R10	10	9.8N	Polyethylene	Plastic	None	40	31 Page (31-C) 57 Page (57-C)
E32-A08 2M	-40 to 70°C	0.53N·m	–	R25	10	9.8N	Polyethylene	Plastic	None	60	37 Page (37-C) 55 Page (55-B)
E32-A08H2 2M	-40 to 300°C *2	0.53N·m	–	R25	10	29.4N	SUS	Glass	None	240	47 Page (47-D) 55 Page (55-C)
E32-A09 2M	-40 to 70°C	0.53N·m	–	R25	10	9.8N	Polyethylene	Plastic	None	60	37 Page (37-F) 55 Page (55-E)
E32-A09H2 2M	-40 to 300°C *2, *3	0.53N·m	–	R25	10	9.8N	SUS	Glass	None	230	47 Page (47-E) 55 Page (55-F)
E32-A12 2M	-40 to 70°C	0.53N·m	–	R25	10	9.8N	Polyethylene	Plastic	None	60	37 Page (37-D) 55 Page (55-D)
E32-C11N 2M	-40 to 70°C	0.98N·m	6.2 ^{+0.5} / ₀ dia.	R4	0	29.4N	PVC and Polyethylene	Plastic	White line on emitter cable	70	09 Page (09-B)
E32-C21N 2M	-40 to 70°C	0.29N·m	3.2 ^{+0.5} / ₀ dia.	R2	0	9.8N	Polyethylene	Plastic	White line on emitter cable	30	97 Page (97-D)
E32-C31 2M	-40 to 70°C	0.78N·m	3.2 ^{+0.5} / ₀ dia.	R25	10	9.8N	Polyethylene	Plastic	White line on emitter cable	40	09 Page (09-D)
E32-C31M 1M	-40 to 70°C	0.78N·m	3.2 ^{+0.5} / ₀ dia.	R10	10	9.8N	Polyethylene	Plastic	White line on emitter cable	40	09 Page (09-E)
E32-C31N 2M	-40 to 70°C	0.29N·m	3.2 ^{+0.5} / ₀ dia.	R4	0	9.8N	PVC and Polyethylene	Plastic	White line on emitter cable	40	09 Page (09-A)
E32-C41 1M	-40 to 70°C	0.78N·m	3.2 ^{+0.5} / ₀ dia.	R25	10	9.8N	Polyethylene	Plastic	White tube on emitter cable	30	23 Page (23-A), (23-D)
E32-C42 1M	-40 to 70°C	0.29N·m	2.2 ^{+0.5} / ₀ dia.	R25	10	9.8N	Polyethylene	Plastic	White tube on emitter cable	30	21 Page (21-A), (21-B)
E32-C42S 1M	-40 to 70°C	0.29N·m	3.2 ^{+0.5} / ₀ dia.	R25	10	4N	Polyolefin	Plastic	White tube on emitter cable	30	21 Page (21-E)
E32-CC200 2M	-40 to 70°C	0.98N·m	6.2 ^{+0.5} / ₀ dia.	R25	10	29.4N	Polyethylene	Plastic	White line on emitter cable	40	09 Page (09-H)
E32-D11 2M	-40 to 70°C	0.98N·m	6.2 ^{+0.5} / ₀ dia.	R4	10	29.4N	PVC	Plastic	None	50	43 Page (43-E)
E32-D11R 2M	-40 to 70°C	0.98N·m	6.2 ^{+0.5} / ₀ dia.	R1	0	29.4N	PVC	Plastic	None	50	09 Page (09-G)
E32-D11U 2M	-40 to 70°C	0.98N·m	6.2 ^{+0.5} / ₀ dia.	R4	10	29.4N	Fluororesin	Plastic	None	60	39 Page (39-I)
E32-D12F 2M	-40 to 70°C	0.78N·m	6.5 ^{+0.5} / ₀ dia.	R40	10	29.4N	Fluororesin	Plastic	None	190	39 Page (39-H)
E32-D15XR 2M	-40 to 70°C	0.15N·m	–	R1	0	29.4N	PVC	Plastic	None	60	15 Page (15-D)
E32-D15YR 2M	-40 to 70°C	0.15N·m	–	R1	0	29.4N	PVC	Plastic	None	60	15 Page (15-E)
E32-D15ZR 2M	-40 to 70°C	0.15N·m	–	R1	0	29.4N	PVC	Plastic	None	60	15 Page (15-F)
E32-D16 2M	-40 to 70°C	0.53N·m	–	R4	10	29.4N	PVC	Plastic	None	70	25 Page (25-E)
E32-D21 2M	-40 to 70°C	0.78N·m	3.2 ^{+0.5} / ₀ dia.	R4	10	9.8N	PVC	Plastic	None	20	43 Page (43-B)
E32-D211R 2M	-40 to 70°C	0.78N·m	4.2 ^{+0.5} / ₀ dia.	R1	0	9.8N	Polyethylene	Plastic	None	40	09 Page (09-F)
E32-D21B 2M	-40 to 70°C	0.78N·m	4.2 ^{+0.5} / ₀ dia.	R4	10	9.8N	PVC	Plastic	None	40	43 Page (43-D)
E32-D21N 2M	-40 to 70°C	0.78N·m	4.2 ^{+0.5} / ₀ dia.	R2	0	9.8N	Polyethylene	Plastic	None	30	97 Page (97-E)
E32-D21R 2M	-40 to 70°C	0.78N·m	3.2 ^{+0.5} / ₀ dia.	R1	0	9.8N	Polyethylene	Plastic	None	20	09 Page (09-C)
E32-D21-S3 2M	-40 to 70°C	0.78N·m	4.2 ^{+0.5} / ₀ dia.	R10	10	9.8N	Polyethylene	Plastic	None	50	19 Page (19-J)
E32-D221B 2M	-40 to 70°C	0.29N·m	3.2 ^{+0.5} / ₀ dia.	R4	10	9.8N	PVC	Plastic	None	40	13 Page (13-D) 43 Page (43-C)
E32-D22B 2M	-40 to 70°C	0.2N·m	1.7 ^{+0.5} / ₀ dia.	R4	10	9.8N	PVC	Plastic	None	30	13 Page (13-A) 43 Page (43-A)

*1 Unbendable length of cable from fiber head.
Do not bend the cable for at least 20 mm from where the cable inserts into the Fiber Amplifier Unit.
*2 The heat-resistant rating is not the same for all parts of the Fiber Unit. Refer to the dimensions diagrams for details.
*3 Avoid rapid temperature changes.

Models	Installation			Cable						Weight (packed state) (g)	Dimensions Page No.
	Ambient temperature	Tightening torque	Mounting hole	Bending radius	Unbendable length*1	Tensile strength	Sheath material	Core material	Emitter/receiver differentiation		
E32-D22R 2M	-40 to 70°C	0.29N · m	3.2 ^{+0.5} / ₀ dia.	R1	0	9.8N	Polyethylene	Plastic	None	40	13 Page 13-C
E32-D22-S1 2M	-40 to 70°C	0.29N · m	4.2 ^{+0.5} / ₀ dia.	R10	10	9.8N	Polyethylene	Plastic	None	45	19 Page 19-I
E32-D24R 2M	-40 to 70°C	0.29N · m	3.2 ^{+0.5} / ₀ dia.	R1	0	9.8N	Polyethylene	Plastic	None	40	19 Page 19-A
E32-D24-S2 2M	-40 to 70°C	0.29N · m	5 ^{+0.5} / ₀ dia.	R25	10	19.6N	Polyethylene	Plastic	None	55	19 Page 19-B
E32-D25XB 2M	-40 to 70°C	0.15N · m	–	R4	10	9.8N	PVC	Plastic	None	40	43 Page 43-F
E32-D25-S3 2M	-40 to 70°C	0.29N · m	–	R10	10	9.8N	Polyethylene	Plastic	None	50	19 Page 19-L
E32-D31-S1 0.5M	-40 to 70°C	0.78N · m	3.2 ^{+0.5} / ₀ dia.	R4	10	9.8N	Polyolefin	Plastic	None	35	19 Page 19-G
E32-D32L 2M	-40 to 70°C	0.29N · m	3.2 ^{+0.5} / ₀ dia.	R25	10	29.4N	Polyethylene	Plastic	Yellow dotted line on emitter cable	50	13 Page 13-E
E32-D32-S1 0.5M	-40 to 70°C	0.29N · m	3.2 ^{+0.5} / ₀ dia.	R4	10	9.8N	Polyolefin	Plastic	None	35	19 Page 19-F
E32-D33 2M	-40 to 70°C	0.29N · m	3.2 ^{+0.5} / ₀ dia.	R25	10	9.8N	Polyethylene	Plastic	None	40	13 Page 13-F 19 Page 19-E
E32-D331 2M	-40 to 70°C	0.29N · m	2.2 ^{+0.5} / ₀ dia.	R4	10	9.8N	Polyethylene	Plastic	None	30	19 Page 19-D
E32-D36P1 2M	-40 to 70°C	0.78N · m	–	R4	10	29.4N	Polyethylene	Plastic	None	60	49 Page 49-D
E32-D36T 2M	-40 to 70°C	–	–	R4	10	29.4N	Polyethylene	Plastic	None	190	51 Page 51-C
E32-D43M 1M	-40 to 70°C	0.29N · m	1.7 ^{+0.5} / ₀ dia.	R4	10	9.8N	Polyethylene	Plastic	None	30	13 Page 13-B 19 Page 19-C
E32-D51 2M	-40 to 150°C *2	0.98N · m	6.2 ^{+0.5} / ₀ dia.	R35	10	29.4N	Fluororesin	Plastic	None	60	47 Page 47-B
E32-D51R 2M	-40 to 100°C *3	0.98N · m	6.2 ^{+0.5} / ₀ dia.	R2	0	29.4N	Polyurethane	Plastic	None	60	47 Page 47-A
E32-D61-S 2M	-60 to 350°C *4	0.98N · m	6.2 ^{+0.5} / ₀ dia.	R25	10	29.4N	SUS	Glass	None	190	47 Page 47-G
E32-D611-S 2M	-60 to 350°C *4	0.98N · m	4.2 ^{+0.5} / ₀ dia.	R25	10	29.4N	SUS	Glass	None	170	47 Page 47-F
E32-D73-S 2M	-40 to 400°C *4	0.78N · m	4.2 ^{+0.5} / ₀ dia.	R25	10	29.4N	SUS	Glass	None	170	47 Page 47-H
E32-D81R-S 2M	-40 to 200°C *4	0.78N · m	6.2 ^{+0.5} / ₀ dia.	R10	10	9.8N	Fluororesin	Glass	None	70	47 Page 47-C
E32-D82F1 4M	-40 to 200°C	0.29N · m	6.5 ^{+0.5} / ₀ dia.	R25	10	29.4N	Fluororesin	Plastic	None	450	51 Page 51-D
E32-DC200BR 2M	-40 to 70°C	0.98N · m	6.2 ^{+0.5} / ₀ dia.	R1	0	29.4N	PVC	Plastic	None	60	19 Page 19-K
E32-DC200F4R 2M	-40 to 70°C	0.78N · m	3.2 ^{+0.5} / ₀ dia.	R1	0	9.8N	Polyethylene	Plastic	None	40	19 Page 19-H
E32-L11FP 2M	-10 to 60°C	0.78N · m	–	R40	10	9.8N	Fluororesin	Plastic	None	310	39 Page 39-F 55 Page 55-G
E32-L11FS 2M	-10 to 85°C	0.78N · m	–	R40	10	9.8N	Fluororesin	Plastic	None	310	39 Page 39-G 55 Page 55-H
E32-L15 2M	-40 to 70°C	0.53N · m	–	R25	10	29.4N	Polyethylene	Plastic	White tube on emitter cable	60	21 Page 21-F
E32-L16-N 2M	-40 to 70°C	0.29N · m	–	R25	10	29.4N	Polyethylene	Plastic	None	60	33 Page 33-A 37 Page 37-B 55 Page 55-A
E32-L24S 2M	-40 to 70°C	0.29N · m	–	R10	10	9.8N	Polyethylene	Plastic	None	40	33 Page 33-B 37 Page 37-A
E32-L25L 2M	-40 to 105°C *3	0.29N · m	–	R10	10	9.8N	Polyethylene	Plastic	None	40	33 Page 33-C 37 Page 37-E
E32-L25T 2M	-40 to 70°C	–	–	R10	10	9.8N	Polyethylene	Plastic	None	40	51 Page 51-B
E32-LD11 2M	-40 to 70°C	0.98N · m	–	R25	10	29.4N	Polyethylene	Plastic	None	40	09 Page 09-I
E32-LD11N 2M	-40 to 70°C	0.98N · m	6.2 ^{+0.5} / ₀ dia.	R2	0	29.4N	Polyethylene	Plastic	None	40	97 Page 97-C
E32-LD11R 2M	-40 to 70°C	0.98N · m	–	R1	0	29.4N	Polyethylene	Plastic	None	40	09 Page 09-I

*1 Unbendable length of cable from fiber head.
Do not bend the cable for at least 20 mm from where the cable inserts into the Fiber Amplifier Unit.
*2 For continuous operation, use the Fiber Unit between -40 to 130°C.
*3 For continuous operation, use the Fiber Unit between -40 to 90°C.
*4 The heat-resistant rating is not the same for all parts of the Fiber Unit. Refer to the dimensions diagrams for details.

Threaded	Standard Installation
Cylindrical	
Flat	Saving Space
Sleeved	
Small Spot	Beam Improvements
High Power	
Narrow view	Transparent Objects
BGS	
Retro-reflective	Environmental Immunity
Limited-reflective	
Chemical-resistant, Oil-resistant	Applications
Bending	
Heat-resistant	Area Detection
Vacuum	FPD, Semi, Solar

- Fiber Sensor Features
- Selection Guide
- Fiber Units
- Standard Installation
 - Threaded
 - Cylindrical
- Saving Space
 - Flat
 - Sleeved
- Beam Improvements
 - Small Spot
 - High Power
 - Narrow view
 - BGS
- Transparent Objects
 - Retro-reflective
 - Limited-reflective
- Environmental Immunity
 - Chemical-resistant, Oil-resistant
 - Bending
 - Heat-resistant
- Applications
 - Area Detection
 - Liquid-level
 - Vacuum
 - FPD, Semi, Solar
- Installation Information
- Fiber Amplifiers, Communications Unit, and Accessories
- Technical Guide and Precautions
- Model Index

Models	Installation			Cable						Weight (packed state) (g)	Dimensions Page No.
	Ambient temperature	Tightening torque	Mounting hole	Bending radius	Unbendable length*1	Tensile strength	Sheath material	Core material	Emitter/receiver differentiation		
E32-LR11NP 2M	-40 to 70°C *2	0.98N · m	6.2 ^{+0.5} ₀ dia.	R2	0	29.4N	Polyethylene	Plastic	None	40	35 Page (35-A) 97 Page (97-G)
E32-LT11 2M	-40 to 70°C	0.78N · m	–	R25	10	29.4N	Polyethylene	Plastic	None	40	07 Page (07-C) 25 Page (25-C)
E32-LT11N 2M	-40 to 70°C	0.78N · m	4.2 ^{+0.5} ₀ dia.	R2	0	29.4N	Polyethylene	Plastic	None	40	25 Page (25-A) 97 Page (97-A)
E32-LT11R 2M	-40 to 70°C	0.78N · m	–	R1	0	29.4N	Polyethylene	Plastic	None	40	07 Page (07-C) 25 Page (25-C)
E32-R16 2M	-25 to 55°C	0.54N · m	–	R25	10	29.4N	Polyethylene	Plastic	None	220 (E39-R1 included.)	35 Page (35-B)
E32-R21 2M	-40 to 70°C	0.39N · m	6.2 ^{+0.5} ₀ dia.	R10	10	9.8N	Polyethylene	Plastic	None	70 (E39-R3 included.)	35 Page (35-C)
E32-T10V 2M	-25 to 70°C	0.3N · m	–	R25	10	29.4N	Fluororesin	Plastic	None	170	53 Page (53-D)
E32-T11 2M	-40 to 70°C	0.78N · m	4.2 ^{+0.5} ₀ dia.	R4	10	29.4N	PVC	Plastic	None	40	41 Page (41-C)
E32-T11F 2M	-40 to 70°C	0.29N · m	–	R4	10	29.4N	Fluororesin	Plastic	None	60	39 Page (39-C)
E32-T11N 2M	-40 to 70°C	0.78N · m	4.2 ^{+0.5} ₀ dia.	R1	0	29.4N	PVC	Plastic	None	70	07 Page (07-A)
E32-T11NF 2M	-25 to 70°C	12N · m	8.5 ^{+0.5} ₀ dia.	R1	0	29.4N	Fluororesin	Plastic	None	80	39 Page (39-A)
E32-T11R 2M	-40 to 70°C	0.78N · m	4.2 ^{+0.5} ₀ dia.	R1	0	29.4N	PVC	Plastic	None	50	07 Page (07-B)
E32-T12F 2M	-40 to 70°C	0.78N · m	5.5 ^{+0.5} ₀ dia.	R40	10	29.4N	Fluororesin	Plastic	None	210	39 Page (39-B)
E32-T12R 2M	-40 to 70°C	0.29N · m	3.2 ^{+0.5} ₀ dia.	R1	0	29.4N	PVC	Plastic	None	60	11 Page (11-C)
E32-T14 2M	-40 to 70°C	0.49N · m	–	R25	10	29.4N	Polyethylene	Plastic	None	60	25 Page (25-D)
E32-T14F 2M	-40 to 70°C	0.78N · m	5.5 ^{+0.5} ₀ dia.	R40	10	29.4N	Fluororesin	Plastic	None	220	39 Page (39-D)
E32-T14LR 2M	-40 to 70°C	0.29N · m	3.2 ^{+0.5} ₀ dia.	R1	0	29.4N	PVC	Plastic	None	60	11 Page (11-D)
E32-T15XR 2M	-40 to 70°C	0.15N · m	–	R1	0	29.4N	PVC	Plastic	None	60	15 Page (15-A)
E32-T15YR 2M	-40 to 70°C	0.15N · m	–	R1	0	29.4N	PVC	Plastic	None	60	15 Page (15-B)
E32-T15ZR 2M	-40 to 70°C	0.15N · m	–	R1	0	29.4N	PVC	Plastic	None	60	15 Page (15-C)
E32-T16JR 2M	-40 to 70°C	0.29N · m	–	R1	0	29.4N	PVC	Plastic	None	60	49 Page (49-B)
E32-T16PR 2M	-40 to 70°C	0.29N · m	–	R1	0	29.4N	PVC	Plastic	None	60	49 Page (49-A)
E32-T16WR 2M	-25 to 55°C	0.29N · m	–	R1	0	9.8N	PVC	Plastic	None	60	49 Page (49-C)
E32-T17L 10M	-40 to 70°C	0.78N · m	14.5 ⁺¹ ₀ dia.	R25	10	29.4N	Polyethylene	Plastic	None	240	25 Page (25-B)
E32-T21 2M	-40 to 70°C	0.78N · m	3.2 ^{+0.5} ₀ dia.	R4	10	9.8N	PVC	Plastic	None	30	41 Page (41-B)
E32-T21-S1 2M	-40 to 70°C	0.78N · m	3.2 ^{+0.5} ₀ dia.	R10	10	9.8N	Polyethylene	Plastic	None	45	17 Page (17-D)
E32-T223R 2M	-40 to 70°C	0.20N · m	1.2 ^{+0.5} ₀ dia.	R1	10	9.8N	Polyethylene	Plastic	None	40	11 Page (11-A)
E32-T22B 2M	-40 to 70°C	0.20N · m	1.7 ^{+0.5} ₀ dia.	R4	10	9.8N	PVC	Plastic	None	40	11 Page (11-B) 41 Page (41-A)
E32-T22S 2M	-40 to 70°C	0.29N · m	3.2 ^{+0.5} ₀ dia.	R10	10	29.4N	PVC	Plastic	None	60	31 Page (31-F)
E32-T24E 2M	-40 to 70°C	0.29N · m	2.7 ^{+0.5} ₀ dia.	R10	10	9.8N	Polyethylene	Plastic	None	40	17 Page (17-B)
E32-T24R 2M	-40 to 70°C	0.29N · m	2.2 ^{+0.5} ₀ dia.	R1	0	9.8N	Polyethylene	Plastic	None	40	17 Page (17-A)
E32-T24S 2M	-40 to 70°C	0.29N · m	–	R10	10	29.4N	PVC	Plastic	None	60	31 Page (31-E) 57 Page (57-E)
E32-T24SR 2M	-40 to 70°C	0.29N · m	–	R1	0	9.8N	PVC	Plastic	None	60	31 Page (31-D) 57 Page (57-D)
E32-T25XB 2M	-40 to 70°C	0.15N · m	–	R4	10	9.8N	PVC	Plastic	None	40	41 Page (41-D)

*1 Unbendable length of cable from fiber head.
Do not bend the cable for at least 20 mm from where the cable inserts into the Fiber Amplifier Unit.
*2 Ambient operating temperature of the recommended reflector (E39-RP1) is -40 to 60°C.

Models	Installation			Cable						Weight (packed state) (g)	Dimensions Page No.
	Ambient temperature	Tightening torque	Mounting hole	Bending radius	Unbendable length*1	Tensile strength	Sheath material	Core material	Emitter/receiver differentiation		
E32-T33 1M	-40 to 70°C	0.29N · m	3.2 ^{+0.5} / ₀ dia.	R10	10	9.8N	Polyethylene	Plastic	None	40	17 Page (17-C)
E32-T51 2M	-40 to 150°C	0.78N · m	4.2 ^{+0.5} / ₀ dia.	R35	10	29.4N	Fluororesin	Plastic	None	70	45 Page (45-B)
E32-T51F 2M	-40 to 150°C *2	0.78N · m	5.5 ^{+0.5} / ₀ dia.	R40	10	29.4N	Fluororesin	Plastic	None	220	39 Page (39-E)
E32-T51R 2M	-40 to 100°C *3	0.78N · m	4.2 ^{+0.5} / ₀ dia.	R2	0	29.4N	Polyurethane	Plastic	None	60	45 Page (45-A)
E32-T51V 1M	-25 to 120°C	0.29N · m	4.2 ^{+0.5} / ₀ dia.	R30	10	29.4N	Fluororesin	Glass	None	160	53 Page (53-A)
E32-T61-S 2M	-60 to 350°C *4	0.78N · m	4.2 ^{+0.5} / ₀ dia.	R25	10	29.4N	SUS	Glass	None	200	45 Page (45-D)
E32-T81R-S 2M	-40 to 200°C *4	0.78N · m	4.2 ^{+0.5} / ₀ dia.	R10	10	9.8N	Fluororesin	Glass	None	60	45 Page (45-C)
E32-T84SV 1M	-25 to 200°C	0.29N · m	4.5 ^{+0.5} / ₀ dia.	R25	10	29.4N	SUS	Glass	None	190	53 Page (53-C)
E32-TC200BR 2M	-40 to 70°C	0.78N · m	4.2 ^{+0.5} / ₀ dia.	R1	0	29.4N	PVC	Plastic	None	60	17 Page (17-E)
E32-VF1	-25 to 70°C	-	-	-	-	-	-	-	-	240	53 Page (53-F)
E32-VF4	-25 to 70°C	-	-	-	-	-	-	-	-	280	53 Page (53-E)
E39-F1	-40 to 200°C	-	-	-	-	-	-	-	-	2	26 Page (26-A) 27 Page (27-A) to (27-C) 28 Page (28-A) 29 Page (29-A) to (29-C)
E39-F1-33	-40 to 200°C	-	-	-	-	-	-	-	-	3	28 Page (28-D)
E39-F11	-	-	-	-	-	-	-	-	-	30	-
E39-F16	-60 to 350°C	-	-	-	-	-	-	-	-	15	26 Page (26-B) 27 Page (27-D) to (27-F) 28 Page (28-B) 29 Page (29-D) to (29-F), (29-K)
E39-F17	-25 to 70°C	-	-	-	-	-	-	-	-	10	21 Page (21-B)
E39-F18	-40 to 70°C	-	-	-	-	-	-	-	-	5	23 Page (23-G), (23-H)
E39-F1V	-25 to 120°C	-	-	-	-	-	-	-	-	3	53 Page (53-B)
E39-F2	-40 to 200°C	-	-	-	-	-	-	-	-	2	26 Page (26-C) 27 Page (27-G), (27-H) 28 Page (28-C) 29 Page (29-G) to (29-I)
E39-F32A 1M	-40 to 150°C	-	-	R30	-	-	-	-	-	70	43 Page (43-G)
E39-F32C 1M	-40 to 150°C	-	-	R30	-	-	-	-	-	110	41 Page (41-E) 43 Page (43-G)
E39-F32D 1M	-40 to 150°C	-	-	R30	-	-	-	-	-	80	43 Page (43-G)
E39-F3A	-40 to 70°C	-	-	-	-	-	-	-	-	2	21 Page (21-A)
E39-F3A-5	-40 to 70°C	-	-	-	-	-	-	-	-	1	23 Page (23-A), (23-B), (23-C)
E39-F3B	-40 to 70°C	-	-	-	-	-	-	-	-	2	23 Page (23-D), (23-E), (23-F)
E39-F3C	-40 to 70°C	-	-	-	-	-	-	-	-	1	21 Page (21-C), (21-D)
E39-R1	-25 to 55°C	-	-	-	-	-	-	-	-	20	35 Page (35-B)
E39-R3	-25 to 55°C	-	-	-	-	-	-	-	-	20	35 Page (35-C)
E39-RP1	-40 to 60°C	-	-	-	-	-	-	-	-	25	35 Page (35-A) 97 Page (97-G)
E39-RP37	-25 to 55°C	-	-	-	-	-	-	-	-	4	-
E39-RSP1	-25 to 55°C	-	-	-	-	-	-	-	-	4	-

*1 Unbendable length of cable from fiber head.
Do not bend the cable for at least 20 mm from where the cable inserts into the Fiber Amplifier Unit.
*2 For continuous operation, use the Fiber Unit between -40 to 130°C.
*3 For continuous operation, use the Fiber Unit between -40 to 90°C.
*4 The heat-resistant rating is not the same for all parts of the Fiber Unit. Refer to the dimensions diagrams for details.

Threaded	Standard Installation
Cylindrical	
Flat	Saving Space
Sleeved	
Small Spot	Beam Improvements
High Power	
Narrow view	
BGS	Transparent Objects
Retro-reflective	
Limited-reflective	
Chemical-resistant, Oil-resistant	Environmental Immunity
Bending	
Heat-resistant	
Area Detection	Applications
Liquid-level	
Vacuum	
FPD, Semi, Solar	

Installation Information

Fiber Amplifiers, Communications Unit, and Accessories

Technical Guide and Precautions

Model Index

Threaded

Cylindrical

Flat

Sleeved

Small Spot

High Power

Narrow view

BGS

Retro-reflective

Limited-reflective

Chemical-resistant, Oil-resistant

Bending

Heat-resistant

Area Detection

Liquid-level

Vacuum

FPD, Semi, Solar

Smart Fiber Amplifier Units

E3NX-FA Series NEW

A Smart Fiber Amplifier Unit with Ultra-stable Detection and Ultra-easy Setup



64
Page

Expanded Application Response Capabilities Advanced Basic Performance

Improvements in the sensing distance and minimum sensing object have increased the range of application for stable detection.

1.5 Times the Sensing Distance*

6 m

For E32-LT11 Fiber Unit with a fiber length of 3.5 m

1/10th the Minimum Sensing Object*

0.3 μm dia.

Typical example of actual measurements with E32-D11R Fiber Unit. *Compared to E3X-HD.

Achieve Easy Detection in Many Applications Advanced Smart Tuning

Just press the **TUNE** button once with a workpiece and once without a workpiece to automatically set the optimum incident level and threshold. Consistent settings are achieved for all users with this ultra-easy procedure.

Press the **TUNE** button **once** with a workpiece and **once** without a workpiece

Automatic Setting of Optimum Values

Threshold + Incident Level

5000 9999

Set to the intermediate value between the incident levels with and without a workpiece. Incident level adjustment with and without a workpiece

Optimum Light Intensity Adjustment from Transparent Objects to Black Workpieces

The incident level is optimized to enable stable detection even for saturated or insufficient incident levels.

Light Intensity Adjustment Range of 40,000 Times

x1/2000 ← x1 → x20

Excessive Incident Level
▶ Incident light reduced.

▶ Incident light increased.

Sensor Communications Units for E3NX-FA

E3NW Series NEW

The Next-generation E3NW Sensor Network Units Revolutionize On-site Sensing



64
Page

The Sensor Communications Unit with a master function and the Distributed Sensor Units with slave functions enable N-Smart Sensors communication over open networks.

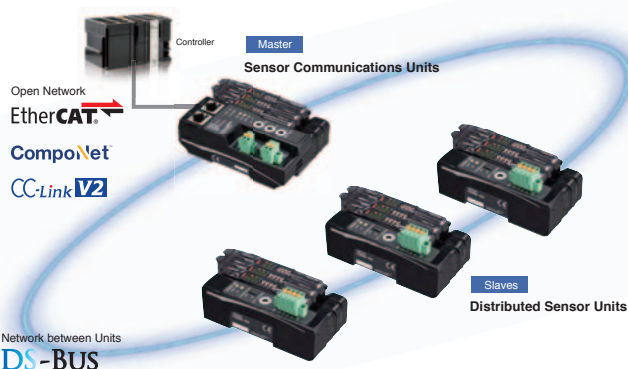

Greatly Reduced Machine Manufacturing Costs

There is no need to change the current distributed installation to introduce a network without increasing costs.

Greatly Reduced Machine Commissioning Time

All of the settings can be made at the same time from a Touch Panel.

Greatly Improved Machine Productivity

Realtime monitoring lets you perform maintenance before malfunctions occur.

Smart Fiber Amplifier Units

E3X-HD Series

Affordable Amplifier Units with Simple Operation and Stable Detection Capabilities



78
Page

Sensor Communications Units for E3X-HD

E3X-ECT / E3X-CRT

Sensor Communications Units for CompoNet and EtherCAT



78
Page

<Fiber Amplifier Unit Comparison>

		E3NX-FA Series <i>NEW</i>	E3X-HD Series	
Fiber Amplifier Unit specifications	Output	1 or 2 outputs (depending on the model)	1 output	
	External input	Supported or not supported (depending on the model)	Not supported	
	Response time	30 μ s (32 μ s)/250 μ s/1 ms/16 ms (Default: 250 μ s)	50 μ s (55 μ s)/250 μ s/1 ms/16 ms (Default: 250 μ s)	
	Sensing distance (Giga-power mode)	E32-T11R	3,000 mm	2,000 mm
		E32-D11R	1,260 mm	840 mm
Minimum sensing object	E32-T11R	2 μ m dia.	5 μ m dia.	
Sensor Communications Unit application	Communications method (Sensor Communications Unit model)	EtherCAT (E3NW-ECT) CompoNet (E3NW-CRT) CC-Link (E3NW-CCL)	EtherCAT (E3X-ECT) CompoNet (E3X-CRT)	
	Applicable Sensors	Fiber Sensor (E3NX-FA0) Laser Sensors (E3NC-LA0, E3NC-SA0) Contact-Type Sensor (E9NC-TA0) *	Fiber Sensor (E3X-HD0) Fiber Sensor (E3X-DA0-S, E3X-MDA0) Laser Photoelectric Sensor (E3C-LDA0) Proximity Sensor (E2C-EDA0)	
Page listings	Ordering Information	64 Page	78 Page	
	Ratings and Specifications	66 Page	80 Page	
	Dimensions	68 Page	80 Page	

* E3NW-CRT Sensor Communications Units (CompoNet) cannot be used.

Fiber Amplifier Unit Accessories

65, 79
Page

Fiber Sensor Features

Selection Guide

Fiber Units

Threaded

Standard Installation

Cylindrical

Flat

Saving Space

Sleeved

Small Spot

High Power

Beam Improvements

Narrow view

BGS

Retro-reflective

Transparent Objects

Limited-reflective

Chemical-resistant, Oil-resistant

Environmental Immunity

Bending

Heat-resistant

Area Detection

Liquid-level

Applications

Vacuum

FPD, Semi, Solar

Installation Information

Fiber Amplifiers, Communications Unit, and Accessories

Technical Guide and Precautions

Model Index

E3NX-FA Fiber Amplifier Units and Related Products **NEW**

Fiber Amplifier Units E3NX-FA Series

Type	Appearance	Connecting method	Inputs/outputs	Models		Ratings and Specifications	Dimensions
				NPN output	PNP output		
Standard models		Pre-wired (2 m)	1 output	E3NX-FA11 2M	E3NX-FA41 2M	Page 66	Page 68 (68-A)
		Wire-saving Connector	1 output	E3NX-FA6	E3NX-FA8		Page 68 (68-B)
Advanced models		Pre-wired (2 m)	2 outputs + 1 input	E3NX-FA21 2M	E3NX-FA51 2M		Page 68 (68-A)
		Wire-saving Connector	1 output + 1 input	E3NX-FA7	E3NX-FA9		Page 68 (68-B)
			2 outputs	E3NX-FA7TW	E3NX-FA9TW		Page 69 (69-A)
		M8 Connector	1 output + 1 input	E3NX-FA24	E3NX-FA54		Page 69 (69-A)
			2 outputs	—	E3NX-FA54TW		Page 69 (69-B)
Model for Sensor Communications Unit*		Connector for Sensor Communications Unit	—	E3NX-FA0	—		Page 69 (69-B)

* A Sensor Communications Unit is required if you want to use the Fiber Amplifier Unit on a network.

Sensor Communications Unit

Sensor Communications Unit

Communication method	Appearance	Applicable Fiber Amplifier Model	Model	Ratings and Specifications	Dimensions
EtherCAT		E3NX-FA0	E3NW-ECT	Page 76	Page 77 (77-A)
CompoNet			E3NW-CRT	*	*
CC-Link			E3NW-CCL	*	*

* For details, refer to your OMRON website.

Distributed Sensor Unit





Appearance	Applicable Fiber Amplifier Model	Model	Ratings and Specifications	Dimensions
	E3NX-FA0	E3NW-DS	Page 76	Page 77 (77-B)

Note. The Distributed Sensor Unit can be connected to any of the Sensor Communications Units.

Accessories (sold separately)



Wire-saving connectors (Required for models for Wire-saving Connectors.)

Connectors are not provided with the Fiber Amplifier Unit and must be ordered separately. * Protective stickers: provided.

Type	Appearance	Cable length	Number of conductors	Applicable Fiber Amplifier Units	Models	Ratings, Specifications and Dimensions
Master Connector		2 m	4	E3NX-FA7 E3NX-FA7TW E3NX-FA9 E3NX-FA9TW	E3X-CN21	Page 88 88-A
Slave Connector			2		E3X-CN22	Page 88 88-B
Master Connector			3	E3NX-FA6 E3NX-FA8	E3X-CN11	Page 88 88-A
Slave Connector			1		E3X-CN12	Page 88 88-B

Sensor I/O Connectors (Required for models with M8 Connectors.)

Connectors are not provided with the Fiber Amplifier Unit and must be ordered separately. * Protective stickers: provided.

Appearance	Cable length	Number of conductors	Models	Ratings and Specifications	Dimensions
Straight 	2 m	4	XS3F-M421-402-A	Page 88	Page 88 88-C
	5 m		XS3F-M421-405-A		
L-shaped 	2 m		XS3F-M422-402-A		Page 88 88-D
	5 m		XS3F-M422-405-A		

Mounting Bracket

A Mounting Bracket is not provided with the Fiber Amplifier Unit and must be ordered separately as required.

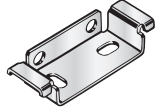
Appearance	Model	Quantity	Dimensions
	E39-L143	1	Page 89 89-A

DIN Track

A Din Track is not provided with the Fiber Amplifier Unit and must be ordered separately as required.

Appearance	Type	Models	Quantity	Dimensions
	Shallow type, total length: 1 m	PPF-100N	1	Page 89 89-B
	Shallow type, total length: 0.5 m	PPF-50N		
	Deep type, total length: 1 m	PPF-100N2		Page 89 89-C

End Plate

Two End Plates are provided with the Sensor Communications Unit.

End Plates are not provided with the Fiber Amplifier Unit and must be ordered separately as required.

Appearance	Model	Quantity	Dimensions
	PPF-M	1	Page 89 89-D

Threaded	Standard Installation
Cylindrical	
Flat	Saving Space
Sleeved	
Small Spot	Beam Improvements
High Power	
Narrow view	
BGS	Transparent Objects
Retro-reflective	
Limited-reflective	
Chemical-resistant, Oil-resistant	Environmental Immunity
Bending	
Heat-resistant	
Area Detection	Applications
Liquid-level	
Vacuum	
FPD, Semi, Solar	Installation Information

Ratings and Specifications

Item	Type	Standard		Advanced					Model for Sensor Communications Unit
	NPN output	E3NX-FA11	E3NX-FA6	E3NX-FA21	E3NX-FA7	E3NX-FA7TW	E3NX-FA24	—	E3NX-FA0
	PNP output	E3NX-FA41	E3NX-FA8	E3NX-FA51	E3NX-FA9	E3NX-FA9TW	E3NX-FA54	E3NX-FA54TW	
	Connecting method	Pre-wired	Wire-saving Connector	Pre-wired	Wire-saving Connector		M8 Connector		Connector for Sensor Communications Unit
Inputs / Outputs	Output	1 output		2 outputs	1 output	2 outputs	1 output	2 outputs	— *1
	External input	—		1 input	1 input	—	1 input	—	
Light source (wavelength)		Red, 4-element LED (625 nm)							
Power supply voltage		10 to 30 VDC, including 10% ripple (p-p)							Supplied from the connector through the Sensor Communications Unit
Power consumption *2		<p>At Power Supply Voltage of 24 VDC.</p> <p>Standard Models or Model for Sensor Communications Unit:</p> <p>Normal mode: 960 mW max. (Current consumption: 40 mA max.)</p> <p>Eco ON: 720 mW max. (Current consumption: 30 mA max.)</p> <p>Eco LO: 840 mW max. (Current consumption: 35 mA max.)</p> <p>Advanced Models:</p> <p>Normal mode: 1,080 mW max. (Current consumption: 45 mA max.)</p> <p>Eco ON: 840 mW max. (Current consumption: 35 mA max.)</p> <p>Eco LO: 960 mW max. (Current consumption: 40 mA max.)</p>							
Control output		<p>Load power supply voltage: 30 VDC max., open-collector output</p> <p>Load current: Groups of 1 to 3 Amplifier Units: 100 mA max.,</p> <p>Groups of 4 to 30 Amplifier Units: 20 mA max.</p> <p>(Residual voltage: At load current of less than 10 mA: 1 V max.,</p> <p>At load current of 10 to 100 mA: 2 V max.)</p> <p>OFF current: 0.1 mA max.</p>							—
External input		—	Refer to *3.		—	Refer to *3.		—	
Indicators		<p>7-segment displays (Sub digital display: green, Main digital display: white)</p> <p>Display direction: Switchable between normal and reversed.</p> <p>OUT indicator (orange), L/D indicator (orange), ST indicator (blue), DPC indicator (green)</p> <p>OUT Selection Indicator (orange)(only on models with 2 outputs)</p>							
Protection circuits		Power supply reverse polarity protection, output short-circuit protection, and output reverse polarity protection							Power supply reverse polarity protection and output short-circuit protection
Response time	Super-high-speed mode (SHS) *4	Operate or reset for model with 1 output: 30 μs, with 2 outputs: 32 μs							
	High-speed mode (HS)	Operate or reset: 250 μs							
	Standard mode (Std)	Operate or reset: 1 ms							
	Giga-power mode (GIGA)	Operate or reset: 16 ms							
Sensitivity adjustment		Smart tuning (2-point tuning, full auto tuning, position tuning, maximum sensitivity tuning, power tuning, or percentage tuning (–99% to 99%)) or manual adjustment							
Maximum connectable Units		30 units							With E3NW-ECT: 30 units *5 With E3NW-CRT: 16 units With E3NW-CCL: 16 units
Mutual interference prevention	Super-high-speed mode (SHS) *4	Possible for up to 0 units							
	High-speed mode (HS)	Possible for up to 10 units							
	Standard mode (Std)	Possible for up to 10 units							
	Giga-power mode (GIGA)	Possible for up to 10 units							
Functions	Auto power control (APC)	Always ON							
	Dynamic power control (DPC)	Provided							
	Timer	Select from timer disabled, OFF-delay, ON-delay, one-shot, or ON-delay + OFF-delay timer. 1ms to 9999ms							
	Zero reset	Negative values can be displayed. (Threshold value is shifted.)							
	Resetting settings *6	Select from initial reset (factory defaults) or user reset (saved settings).							

*1. Two sensor outputs are allocated in the programmable logic controller PLC I/O table.
PLC operation via Communications Unit enables reading detected values and changing settings.

*2. At Power Supply Voltage of 10 to 30 VDC.
Standard Models or Model for Sensor Communications Unit:
Normal mode: 1,080 mW max. (Current consumption: 36 mA max. at 30 VDC, 108 mA max. at 10 DVC)
Eco ON: 880 mW max. (Current consumption: 28 mA max. at 30 VDC, 88 mA max. at 10 VDC)
Eco LO: 980 mW max. (Current consumption: 32 mA max. at 30 VDC, 98 mA max. at 10 VDC)
Advanced Models:
Normal mode: 1,230 mW max. (Current consumption: 41 mA max. at 30 VDC, 123 mA max. at 10 DVC)
Eco ON: 1,030 mW max. (Current consumption: 33 mA max. at 30 VDC, 103 mA max. at 10 VDC)
Eco LO: 1,130 mW max. (Current consumption: 37 mA max. at 30 VDC, 113 mA max. at 10 VDC)

*3. The following details apply to the input.

	Contact input (relay or switch)	Non-contact input (transistor)	Input time*3-1
NPN type	ON: Shorted to 0V (Sourcing current: 1 mA max.). OFF: Open or shorted to Vcc.	ON: 1.5V max. (Sourcing current: 1 mA max.). OFF: Vcc – 1.5 V to Vcc (Leakage current: 0.1 mA max.)	ON : 9ms min. OFF : 20ms min.
PNP type	ON: Shorted to Vcc (Sinking current: 3 mA max.). OFF: Open or shorted to 0V.	ON: Vcc – 1.5 V to Vcc (Sinking current: 3 mA max.). OFF: 1.5V max.(Leakage current: 0.1 mA max.)	

*3-1. Input time is 25 ms (ON)/(OFF) only when (in tUnE) or (in PtUn) input is selected.

*4. The mutual interference prevention function is disabled if the detection mode is set to super-high-speed mode.

*5. When connected to an OMRON NJ-series Controller.

*6. The bank is not reset by the user reset function or saved by the user save function.

Item	Type	Standard		Advanced					Model for Sensor Communications Unit
	NPN output	E3NX-FA11	E3NX-FA6	E3NX-FA21	E3NX-FA7	E3NX-FA7TW	E3NX-FA24	—	E3NX-FA0
	PNP output	E3NX-FA41	E3NX-FA8	E3NX-FA51	E3NX-FA9	E3NX-FA9TW	E3NX-FA54	E3NX-FA54TW	
	Connecting method	Pre-wired	Wire-saving Connector	Pre-wired	Wire-saving Connector		M8 Connector		Connector for Sensor Communications Unit
Functions	Eco mode ^{*7}	Select from OFF (digital displays lit), Eco ON (digital displays not lit) or Eco LO (digital displays dimmed)							
	Bank switching	Select from banks 1 to 4.							
	Power tuning	Select from ON or OFF.							
	Output 1	Select from normal detection mode, or area detection mode.							
	Output 2	—	Select from normal detection mode, alarm output mode, or error output mode.	—	Select from normal detection mode, alarm output mode, or error output mode.	—	Select from normal detection mode, alarm output mode, or error output mode.		
	External input	—	Select from input OFF, tuning, power tuning, emission OFF, zero reset, or bank switching.	—	Select from input OFF, tuning, power tuning, emission OFF, zero reset, or bank switching.	—	Select from input OFF, tuning, power tuning, emission OFF, zero reset, or bank switching.		
	Hysteresis width	Select from standard setting or user setting. For a user setting, the hysteresis width can be set to from 0 to 9,999.							
Ambient Illumination (Receiver side)		Incandescent lamp: 20,000 lx max., Sunlight: 30,000 lx max.							
Ambient temperature range		Operating: Groups of 1 to 2 Amplifier Units: -25 to 55°C, Groups of 3 to 10 Amplifier Units: -25 to 50°C, Groups of 11 to 16 Amplifier Units: -25 to 45°C, Groups of 17 to 30 Amplifier Units: -25 to 40°C Storage: -30 to 70°C (with no icing or condensation)					Operating: Groups of 1 to 2 Amplifier Units: 0 to 55°C, Groups of 3 to 10 Amplifier Units: 0 to 50°C, Groups of 11 to 16 Amplifier Units: 0 to 45°C, Groups of 17 to 30 Amplifier Units: 0 to 40°C Storage: -30 to 70°C (with no icing or condensation)		
Ambient humidity range		Operating and storage: 35% to 85% (with no condensation)							
Altitude		2,000 m max.							
Installation environment		Pollution degree 3 (as per IEC 60947-1)							
Insulation resistance		20 MΩ min. (at 500 VDC)							
Dielectric strength		1,000 VAC at 50/60 Hz for 1 min							
Vibration resistance (destruction)		10 to 55 Hz with a 1.5-mm double amplitude for 2 hours each in X, Y, and Z directions							
Shock resistance (destruction)		500 m/s ² for 3 times each in X, Y, and Z directions					150 m/s ² for 3 times each in X, Y, and Z directions		
Weight (packed state/unit only)		Approx. 115 g/ Approx. 75 g	Approx. 60 g/ Approx. 20 g	Approx. 115 g/ Approx. 75 g	Approx. 60 g/Approx. 20 g		Approx. 65 g/Approx. 25 g		
Materials	Case	Polycarbonate (PC)							
	Cover	Polycarbonate (PC)							
	Cable	PVC							
Accessories		Instruction Manual							

*7. Eco LO is supported for Amplifier Units manufactured in July 2014 or later.

Fiber Sensor Features

Selection Guide

Fiber Units

Threaded	Standard Installation
Cylindrical	
Flat	Saving Space
Sleeved	
Small Spot	Beam Improvements
High Power	
Narrow view	
BGS	Transparent Objects
Retro-reflective	
Limited-reflective	
Chemical-resistant, Oil-resistant	Environmental Immunity
Bending	
Heat-resistant	
Area Detection	Applications
Liquid-level	
Vacuum	
FPD, Semi, Solar	

Installation Information

Fiber Amplifiers, Communications Unit, and Accessories

Technical Guide and Precautions

Model Index

Dimensions

(Unit: mm)
Tolerance class IT16 applies to demensions in this date sheet unless otherwise specified.

Pre-wired Amplifier Units

- 68-A E3NX-FA11
- E3NX-FA21
- E3NX-FA41
- E3NX-FA51

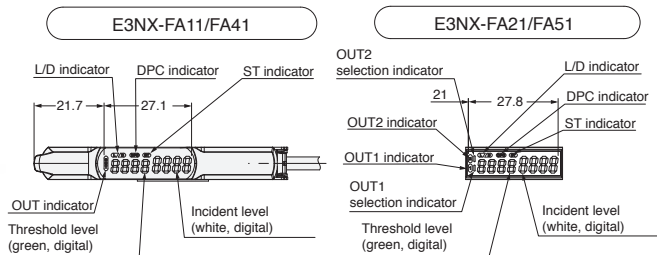

*Cable Specifications

Models	Outer diameter	Number of conductors	Others
E3NX-FA11	4.0 dia.	3	Conductor cross-section: 0.2 mm ² Insulator dia.: 0.9 mm Standard length: 2 m Minimum bending radius: 12 mm
E3NX-FA41	4.0 dia.	3	
E3NX-FA21	4.0 dia.	5	
E3NX-FA51	4.0 dia.	5	

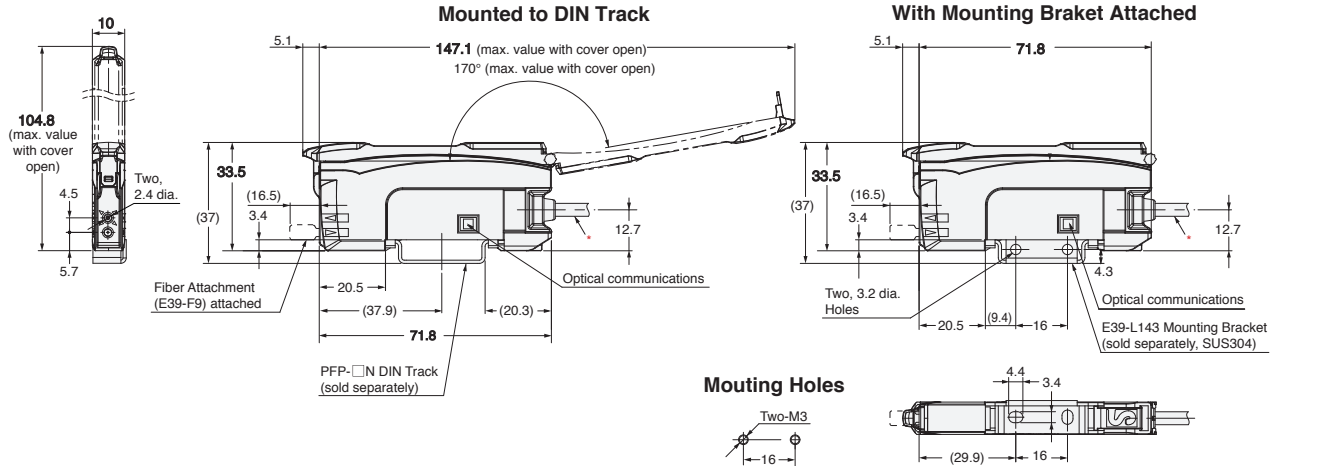

Amplifier Units with Wire-saving Connectors

- 68-B E3NX-FA6
- E3NX-FA7
- E3NX-FA7TW
- E3NX-FA8
- E3NX-FA9
- E3NX-FA9TW

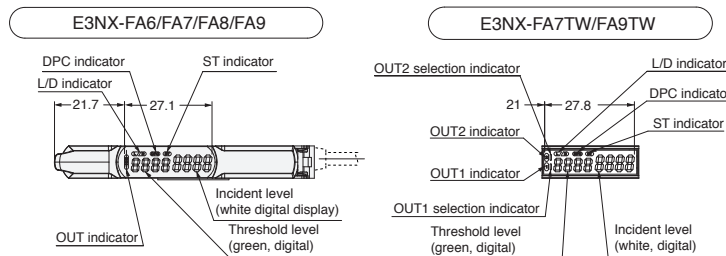

*Cable Specifications

Models	Outer diameter	Number of conductors
E3X-CN12	2.6 dia.	1
E3X-CN22	2.6 dia.	2
E3X-CN11	4.0 dia.	3
E3X-CN21	4.0 dia.	4

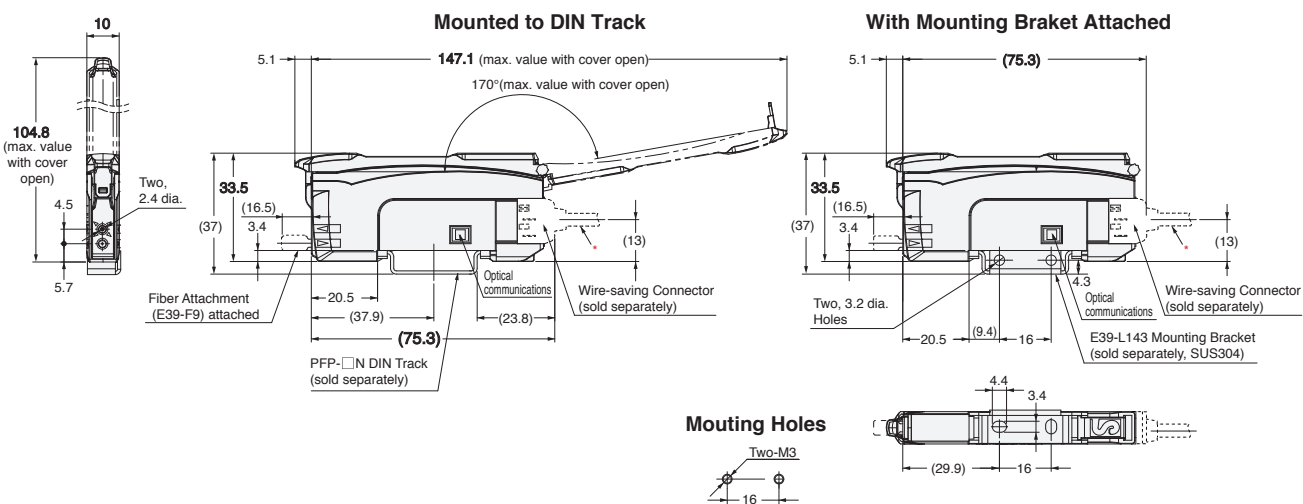

Amplifier Units with M8 Connector

- 69-A E3NX-FA24
- E3NX-FA54
- E3NX-FA54TW

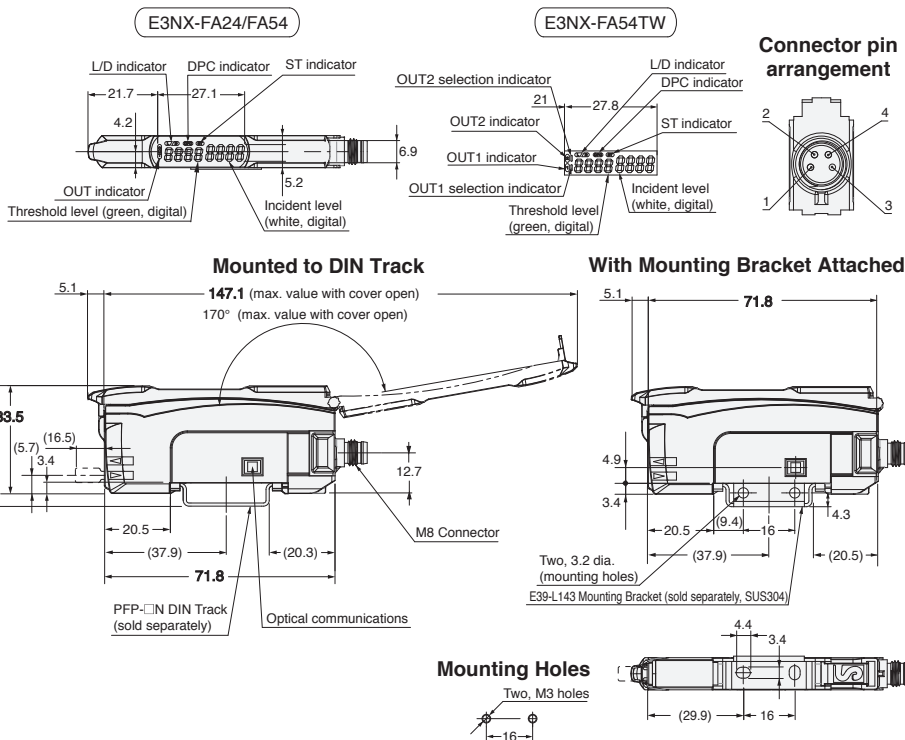

Amplifier Unit with Connector for Sensor Communications Unit

- 69-B E3NX-FA0

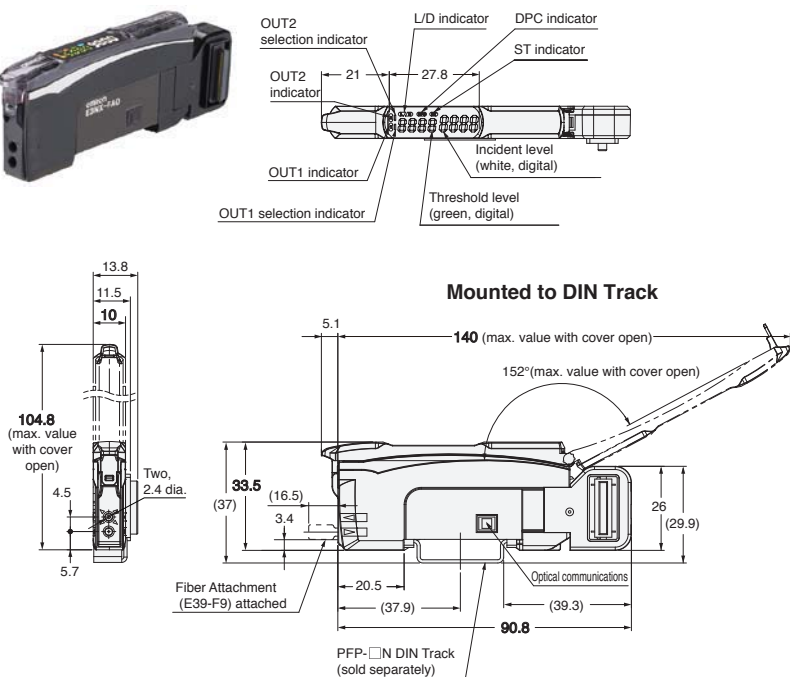

Fiber Sensor Features

Selection Guide

Fiber Units

Threaded	Standard Installation
Cylindrical	
Flat	Saving Space
Sleeved	
Small Spot	Beam Improvements
High Power	
Narrow view	Transparent Objects
BGS	

Retro-reflective	Transparent Objects
Limited-reflective	

Chemical-resistant, Oil-resistant	Environmental Immunity
Bending	
Heat-resistant	

Area Detection	Applications
Liquid-level	
Vacuum	

Installation Information

Fiber Amplifiers, Communications Unit, and Accessories

Technical Guide and Precautions

Model Index

I/O Circuit Diagrams

NPN Output

Models	Operation mode	Timing chart	L/D indicators	Output circuit
E3NX-FA11 E3NX-FA6	Light-ON		L lit.	
	Dark-ON		D lit.	
E3NX-FA21	Light-ON		L lit.	
	Dark-ON		D lit.	
E3NX-FA7 E3NX-FA24	Light-ON		L lit.	
	Dark-ON		D lit.	
E3NX-FA7TW	Light-ON		L lit.	
	Dark-ON		D lit.	

• M8 Connector Pin Arrangement

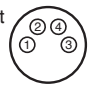

Fiber Sensor Features

Selection Guide

Fiber Units

Standard Installation

Threaded

Cylindrical

Saving Space

Flat

Sleeved

Beam Improvements

Small Spot

High Power

Narrow view

BGS

Transparent Objects

Retro-reflective

Limited-reflective

Environmental Immunity

Chemical-resistant, Oil-resistant

Bending

Heat-resistant

Applications

Area Detection

Liquid-level

Vacuum

FPD, Semi, Solar

Installation Information

Fiber Amplifiers, Communications Unit, and Accessories

Technical Guide and Precautions

Model Index

PNP Output

Models	Operation mode	Timing chart	L/D indicators	Output circuit
E3NX-FA41 E3NX-FA8	Light-ON		L lit.	
	Dark-ON		D lit.	
E3NX-FA51	Light-ON		L lit.	
	Dark-ON		D lit.	
E3NX-FA9 E3NX-FA54	Light-ON		L lit.	
	Dark-ON		D lit.	<p>• M8 Connector Pin Arrangement</p>
E3NX-FA9TW E3NX-FA54TW	Light-ON		L lit.	
	Dark-ON		D lit.	<p>• M8 Connector Pin Arrangement</p>

Plug (Sensor I/O Connector)

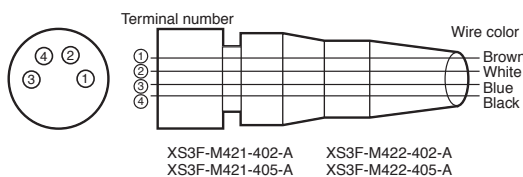

Wire color	Connection pin	Application
Brown	1	Power supply (+V)
White	2	External input / Output
Blue	3	Power supply (0 V)
Black	4	Output

Fiber Sensor Features

Selection Guide

Fiber Units

Threaded

Cylindrical

Flat

Sleeved

Small Spot

High Power

Narrow view

BGS

Retro-reflective

Limited-reflective

Chemical-resistant, Oil-resistant

Bending

Heat-resistant

Area Detection

Liquid-level

Vacuum

FPD, Semi, Solar

Installation Information

Fiber Amplifiers, Communications Unit, and Accessories

Technical Guide and Precautions

Model Index

Nomenclature

E3NX-FA11/FA41/FA6/FA8/FA7/FA9/FA24/FA54

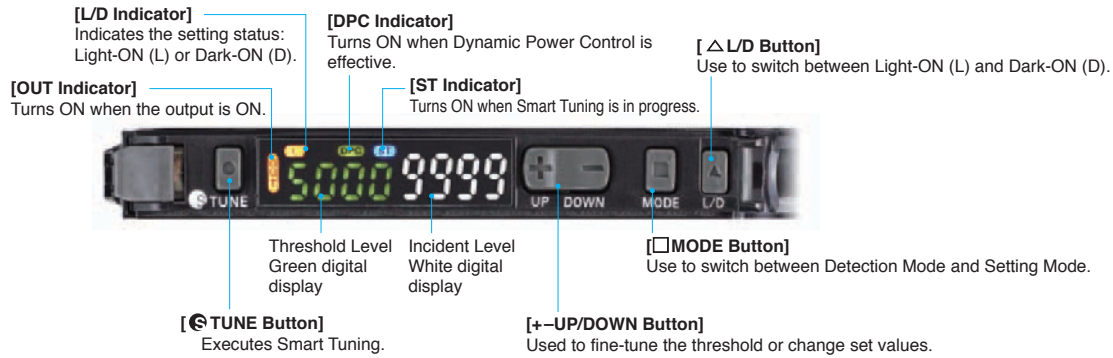

E3NX-FA21/FA51/FA7TW/FA9TW/FA54TW/FA0

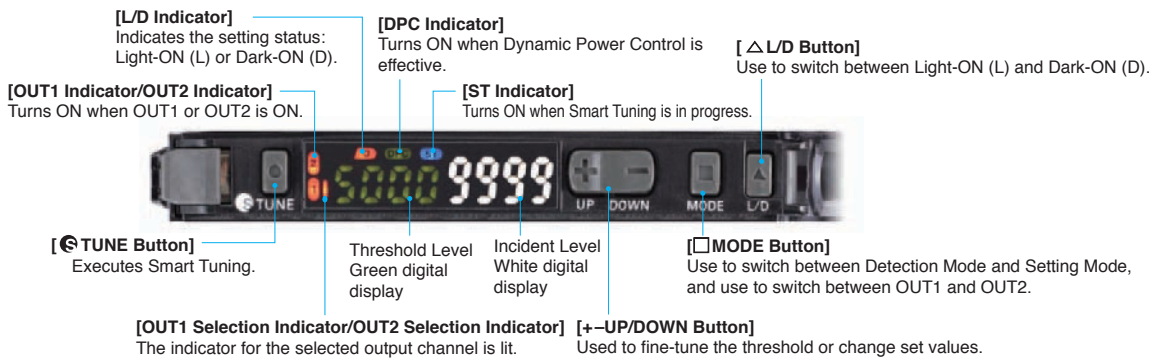

Operating Procedures

Basic Settings

Output switching

1. Press button.

Through-beam:
Set to "Dark ON" to turn the output ON with a workpiece in the detection area. [L/D Indicator] turns **D** ON.

Reflective:
Set to "Light ON" to turn the output ON with a workpiece in the detection area. [L/D Indicator] turns **L** ON.

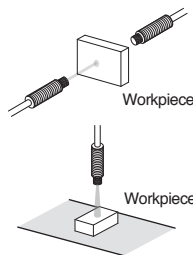

Smart Tuning [Easy Sensitivity Setting]

(1) Detect for Workpiece Presence/Absence

● 2-point Tuning

1. Press button with a workpiece in the detection area.

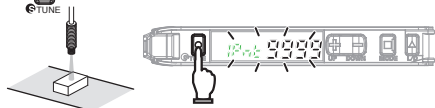

2. Press button again without a workpiece in the detection area. Release the button when [29.99] is displayed.

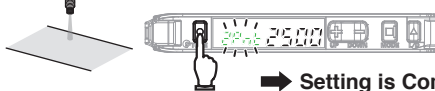

Incident light level setting:
The larger incident level of the Step 1 and 2 values is adjusted to the power tuning level.
Threshold setting:
Set to the middle between the Step 1 and 2 incident light levels.

Step 1 and Step 2 can be reversed.

(2) Enhance Durability of the Fiber Head against Dust and Dirt

● Maximum Sensitivity Tuning

1. Hold button for 3 seconds or longer with/without workpiece as shown below. Release the button when [FULL] is displayed.

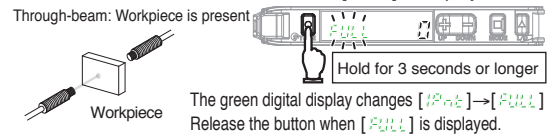

➔ Setting is Completed

Incident light level setting:
The incident level in Step 1 is adjusted to "0".
Threshold setting:
The value is set to approx. 7% of the incident light level of 1.
 However, the Sensor becomes more susceptible to the influence of background objects.

(3) Adjust for Moving Workpiece without Stopping Line

● Full Auto Tuning

1. Hold the button without the presence of a workpiece, and pass the workpiece through while [19.99]→[FULL]→[Auto] is displayed in green digital.

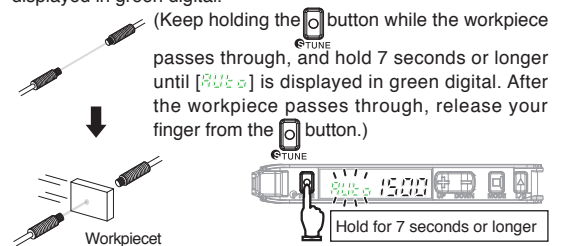

➔ Setting is Completed

Incident light level setting: Adjust the max. incident light level on Step 1 as the power tuning level.
Threshold setting: Set to the middle between max. and min. incident light levels on Step 1.

Basic Settings

(4) Determine Workpiece Position

● Position Tuning

1. Turn ON power tuning in SET mode. Refer to "Detailed Settings"

2. Press button without a workpiece in the area.

3. Place the workpiece at the desired position and hold button.

Hold for 3 seconds or longer

The green digital display changes [9999] → [99.5].
➔ Setting is Completed

Incident light level setting: The Step 3 incident level is adjusted to half the power tuning level.
 Threshold setting: Set to the same value as the Step 3 incident level.

(5) Detect Transparent or Small Workpiece (Set Threshold by incident light level percentage)

● Percentage Tuning

1. Turn ON Percentage Tuning in SET mode. Refer to "Detailed Settings"

2. Press button without a workpiece in the area.

Hold for 1 sec. or longer

➔ Setting is Completed

Incident light level setting: The Step 2 incident light level is adjusted to the power tuning level.
 Threshold setting: Set to the value obtained by [Incident Level at Step 2 × (1 + Percentage Tuning Level)].

No Smart Tuning other than Power Tuning can be used if Percentage Tuning is set.

(6) Restore from the Incident Level Changed due to Dust and Dirt

● Power Tuning

1. Hold and buttons for 1 second or longer without a workpiece in the area.

Hold both for 1 sec. or longer

➔ Setting is Completed

Incident light level setting: The Step 1 incident level is adjusted to the power tuning level.
 Threshold setting: Not changed.

Perform the procedure with a workpiece in the area for reflective model setting. If the setting is made after position tuning, set both the through-beam model and reflective model with a workpiece.

Refer to "Smart Tuning Error" for error displays.

● Smart Tuning Error

Error / Display / Cause	Error Origin Tuning Type	Remedy
Near Error 	2-point Tuning Full Auto Tuning	<ul style="list-style-type: none"> Change the detection function mode to a slower response time mode. Reduce the distance between the emitter and receiver. (Through-beam) Place the Fiber Head closer to the sensing object. (Reflective)
Over Error 	All	<ul style="list-style-type: none"> Use a thin-diameter fiber. Widen the emitter and receiver distance. (Through-beam) Distance the Fiber Head from the sensing object. (Reflective)
Low Error 	Tuning other than Maximum Sensitivity Tuning	<ul style="list-style-type: none"> Reduce the distance between the emitter and receiver. (Through-beam) Place the Fiber Head closer to the sensing object. (Reflective)

Refer to "Detailed Settings" to change the power tuning level.

Channel switching

(Models with 2 Outputs: E3NX-FA21, E3NX-FA51, E3NX-FA7TW, E3NX-FA9TW) and E3NX-FA54TW)

■ The OUT selection indicators and the settings will change.

1. Press button for 1 second.
2. The OUT selection indicators (OUT1/OUT2) switch.

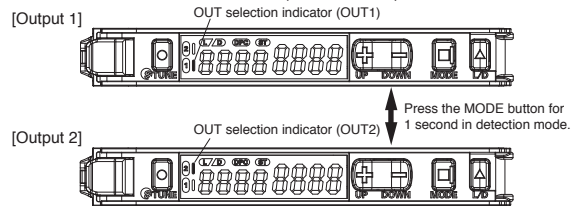

In the detailed settings, the OUT selection indicators will each light whenever the output (OUT1/OUT2) is set.

Minute Adjustment of Threshold Level

1. Press button to adjust the threshold level.

The threshold level becomes higher. The threshold level becomes lower.

Hold the key for high-speed level adjustment.

Convenient Setting Features

(1) Stable Detection Regardless of Incident Level Change due to Dust and Dirt

- DPC Function (Use of the function with Through-beam model or Retro-reflective model is recommended)

1. Perform Smart Tuning.

Refer to "Smart Tuning"
 Refer to "Power Tuning"

2. Set the DPC function ON in SET mode.

Refer to "Detailed Settings".

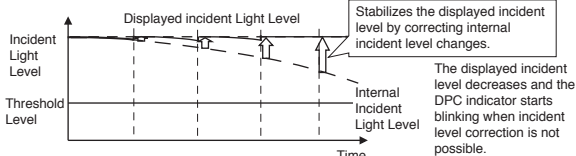
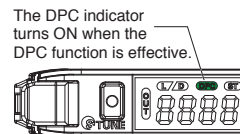

(2) Reset Settings

- Setting Reset

Initializes all the settings by returning them to the factory defaults.

1. Hold button and then hold button for 3 seconds or longer.

2. Select [] in and press .

3. Select [] in and press .

(3) Save or Read Settings

1. Hold button and then hold button for 3 seconds or longer.

- User Save Function

Saves the current settings.

2. Select [] in and press .

3. Select [] in and press .

- User Reset Function

Reads out the saved settings.

2. Select [] in and press .

3. Select [] in and press .

(4) Prevent Mistake-operation

- Key Lock Function

Disables all button operations. [] is displayed when the button is pressed.

- Enable/Cancel (This procedure)

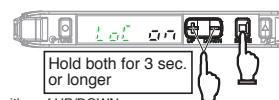

* Press either of UP/DOWN.

Convenient Setting Features

(5) Reset Incident Light Level to "0"

● Zero Reset Function

Changes the incident light level to "0". The threshold level is also shifted accordingly. The lower limit of the threshold is -1,999.

■ Enable

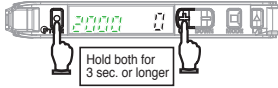

■ Cancel

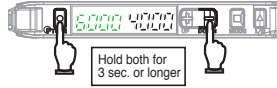

(6) Producing an Output When the Incident Level is within an Area

● Area Detection Mode

1. Select [SET Mode] – [OUT1 Mode] – [Area Detection Mode]. Press button for at least 3 seconds to leave the SET mode.

2. Press button in [Detection Mode] to display OUT1 HIGH and OUT 1 LOW. "HIGH" and "LOW" will appear on the green digital display.

3. Press button for the high and low thresholds to execute smart tuning.

Percentage Tuning: The thresholds are set as follows:
 High: Incident level from step 3 + Incident level from step 3 × Percentage tuning level
 Low: Incident level from step 3 – Incident level from step 3 × Percentage tuning level

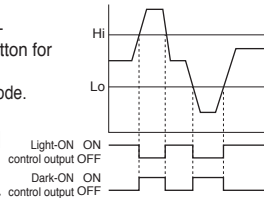

(7) Monitoring the Incident Level for Sensing Objects Passing at High Speed

● Change Finder

1. Select [SET Mode] → [Digital Display] to set [].

The maximum value and minimum value are displayed with Light-ON and Dark-ON respectively.

2. Press button for 3 seconds or longer to leave the SET mode.

3. Send a workpiece past the Fiber Unit.

4. The maximum and minimum incident levels will be displayed for 0.5 seconds when the workpiece passes.

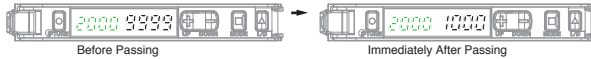

(8) Determining If the Workpiece Can Be Detected

● Solution Viewer

1. Press button and button together for 3 seconds or longer to set []. To clear the setting, press button and button together for 3 seconds or longer to set [].

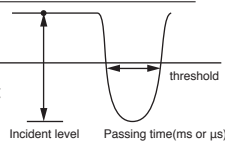

2. Send a workpiece past the Fiber Unit.

3. Displaying the Passing Time and Difference in Incident Levels.

4. Press button and button together for 3 seconds or longer to leave SET mode.

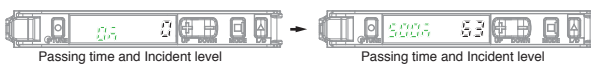

Detailed Settings

Hold button for 3 seconds or longer to enter SET mode. The OUT selection indicators shows items for output 1 or output 2 individually for each output. SET mode provides the function settings described hereafter. The initial display shown after transition from one function to another represents the factory default.

Function Setting	Description															
1. Function Selection 	Changing Functions to Set in SET mode [FINE]: Functions 1. to 5. can be set [SP]: Functions 1. to 16. can be set.															
2. Detection Function (a) (b) (c) (d)	Changing Light Level and Response Time <table border="1"> <thead> <tr> <th>Detection Function</th> <th>Response Time</th> <th>Light Level</th> </tr> </thead> <tbody> <tr> <td>(a) HS High-speed mode</td> <td>250 μs</td> <td>1(Standard)</td> </tr> <tr> <td>(b) STND Standard mode</td> <td>1ms</td> <td>1 time</td> </tr> <tr> <td>(c) GIGA Giga mode</td> <td>16ms</td> <td>8 times</td> </tr> <tr> <td>(d) SHS Super-high-speed mode*</td> <td>30μs</td> <td>0.25 times</td> </tr> </tbody> </table> Smart Tuning is canceled if the detection mode is changed. * The communication and mutual interference prevention functions are disabled when the detection mode is set to super-high-speed mode. The response time for models with 2 outputs is 32 μs.	Detection Function	Response Time	Light Level	(a) HS High-speed mode	250 μs	1(Standard)	(b) STND Standard mode	1ms	1 time	(c) GIGA Giga mode	16ms	8 times	(d) SHS Super-high-speed mode*	30μs	0.25 times
Detection Function	Response Time	Light Level														
(a) HS High-speed mode	250 μs	1(Standard)														
(b) STND Standard mode	1ms	1 time														
(c) GIGA Giga mode	16ms	8 times														
(d) SHS Super-high-speed mode*	30μs	0.25 times														
3. DPC Function 	Stable Detection Regardless of Incident Light Level Change 															
4. Timer Function (a) (b) (c) (d)	Setting Output Timer (Settings are displayed for both outputs for models with 2 outputs.) <table border="1"> <thead> <tr> <th>Off-delay Timer</th> <th>On-delay Timer</th> <th>One-shot Timer</th> <th>ON/OFF-delay Timer</th> </tr> </thead> <tbody> <tr> <td> </td> <td> </td> <td> </td> <td> </td> </tr> </tbody> </table>	Off-delay Timer	On-delay Timer	One-shot Timer	ON/OFF-delay Timer											
Off-delay Timer	On-delay Timer	One-shot Timer	ON/OFF-delay Timer													
5. Power Tuning Level 	Changing the Target Incident Light Level (Power Tuning Level) Use button to set the power tuning level. [100 to 9999 in 1 steps; the initial value: 9999] 															
6. BANK Switching 	Saving Settings in Each Bank															

Threaded	Standard Installation
Cylindrical	
Flat	Saving Space
Sleeved	
Small Spot	Beam Improvements
High Power	
Narrow view	Transparent Objects
BGS	
Retro-reflective	Environmental Immunity
Limited-reflective	
Chemical-resistant, Oil-resistant	Applications
Bending	
Heat-resistant	Applications
Area Detection	
Liquid-level	Applications
Vacuum	
FPD, Semi, Solar	Installation Information

Function Setting

7. Power Tuning ON/OFF Setting

8. Percentage Tuning

9. Output 1 Mode

10. Output 2 Mode

11. External Input

12. Digital Display

Description

Setting ON or OFF Incident Level Adjustment when Tuning

Setting ON or OFF Incident Level Adjustment when Tuning

Detecting Transparent or Small Workpiece

Press [MODE] button in [P Er ON] menu, then use [UP/DOWN] button to set the percentage tuning level.

(-99% to 99% in 1% steps; the initial value: -10%)

Refer to "Smart Tuning"

Changing the Output Mode for Output 1

Changing the Output Mode for Output 2

Alarm Output Mode:
Press [MODE] button and then set the alarm output level with [UP/DOWN] button.

(0 to 100 P in 1-P increments, default: 50 P) ON-delay of 300 ms is applied.

Error Output Mode:
An output is made when a DPC error, EEPROM error, or Load short circuit detection error occurs.

Changing the Type of External Input

The closed-circuit input time for tuning is the same as the key input time.

	First point	Second point
2-point Tuning	Less than 3 seconds	Less than 3 seconds
Maximum Sensitivity Tuning	3 seconds min. Less than 7 seconds	—
Full Auto Tuning	7.0 s or longer	—
Position Tuning	Less than 3 seconds	3 seconds or longer
	Enable	Cancel
Zero reset	Less than 3 seconds	3 seconds min.

Enable/Cancel of Zero reset is the timing when input is turned off.

Changing Digital Display in RUN Mode for Specific Purpose

Checking a Margin Against Threshold

Threshold	Light Level Ratio	
(a)	2000	1000

The ratio of the incident light level to the threshold is displayed in white digital figures.

Setting Threshold using a Small or Fast Moving Workpiece

Peak Light Level	Bottom Light Level	
(b)	2000	2000

Holds and displays the minimum value of the peak of the light incident and the maximum value of the bottom of the light interruption.

Setting for Intuitive Analog Display

Threshold		
(c)	120%	100%

Displays the current level in the 80 to 120% range against the threshold value (100%).

Adjusting Optical Axis

Peak Light Level	Light Level	
(d)	2000	2000

Holds the peak incident light level and displays it in green digital figures.

Checking the Channel No. in Group Mounting

Ch. No.	Light Level	
(e)	100	2000

Checking the Channel No. in Group Mounting.

Checking the Light Level of Fast Moving Workpiece

Threshold	Light level when the workpiece passes	
(f)	2000	2000

Light level when the workpiece passes is displayed in white digital figures for 0.5 seconds.

Function Setting

13. Inverted Display

14. Eco Function

15. Hysteresis width

16. Using the External Input to Write to EEPROM

Description

Mounting Amplifier in Inverted Direction

Inverts the display upside down. The digital display shows the threshold value in green, and light incident level in white.

Saving Power Consumption

ECo on Indicators (Green and White digital displays) turn OFF in approx. 10 seconds after a key operation.

ECo Lo Indicators (Green and White digital displays) turn ON with low brightness in approx. 10 seconds after a key operation.

Changing the Hysteresis Width

The hysteresis width is set to a default value. The hysteresis width is set so that the judgement output is stable near the threshold value.

Be sure to check the stability of outputs as there is a possibility of chattering.

Press [MODE] button with [Hyst] displayed and then set the hysteresis width with [UP/DOWN] button.

(0 to 9999)

Turning ON and OFF Writing to EEPROM

The settings that have been changed by an external input with [In] will not be overwritten to prevent EEPROM from reaching its lifespan (1,000,000 writings).

Threaded

Cylindrical

Flat

Sleeved

Small Spot

High Power

Narrow
view

BGS

Retro-
reflectiveLimited-
reflectiveChemical-
resistant,
Oil-resistant

Bending

Heat-
resistantArea
Detection

Liquid-level

Vacuum

FPD,
Semi,
Solar

Ratings and Specifications

Item	Models	E3NW-ECT	E3NW-DS
Connectable Sensor Amplifier Units	N-Smart		
	Smart Fiber Amplifier Unit:	E3NX-FA0	
	Smart Laser Amplifier Unit:	E3NC-LA0	
	Smart Laser Amplifier Unit (CMOS type):	E3NC-SA0	
	Contact-Type Smart Amplifier Unit:	E9NC-TA0 *1	
Power supply voltage	24VDC (20.4 to 26.4 VDC)		
Power and current consumption	2.4 W max. (Not including the power supplied to Sensor.) 100 mA max. (Not including the current supplied to Sensor.)	2 W max. (Not including the power supplied to Sensor.) 80 mA max. (Not including the current supplied to Sensor.)	
Indicators	L/A IN Indicator (Green), L/A OUT Indicator (Green), PWR Indicator (Green), RUN Indicator (Green), ERROR Indicator (Red), and SS (Sensor Status) indicator (Green/Red)	RUN Indicator (Green), and SS (Sensor Status) indicator (Green/Red)	
Vibration resistance (destruction)	10 to 60 Hz with a 0.7-mm double amplitude, 60 to 150 Hz 50 m/s ² for 1.5 hours each in X, Y, and Z directions		
Shock resistance (destruction)	Destruction: 150 m/s ² for 3 times each in X, Y, and Z directions		
Ambient temperature range	Operating: 0 to 55°C, *2 Storage: -30 to 70°C (with no icing or condensation)		
Ambient humidity range	Operating and storage: 25% to 85% (with no condensation)		
Maximum connectable Sensors	30 *3	10	
Maximum connectable Distributed Sensor units	8	—	
Insulation resistance	20 MΩ min. (at 500 VDC)		
Dielectric strength	500 VAC 50/60Hz 1 min		
Mounting method	35-mm DIN track-mounting		
Weight (packed state/unit only)	Approx. 185 g/Approx. 95 g	Approx. 160 g/Approx. 40 g	
Materials	Polycarbonate		
Accessories	Power supply connector, Communications connector, Connector cover, DIN track End Plates and Instruction manual	Power supply/communications connector, Connector cover, DIN track End Plates, Ferrite core and Instruction manual	

*1. The E9NC-TA0 is supported for firmware version 1.03 or higher (Sensor Communications Units manufactured in July 2014 or later).

*2. Temperature Limitations Based on Number of Connected Amplifier Units:

Groups of 1 or 2 Amplifiers: 0 to 55°C, Groups of 3 to 10 Amplifiers: 0 to 50°C, Groups of 11 to 16 Amplifiers: 0 to 45°C, Groups of 17 to 30 Amplifiers: 0 to 40°C

*3. A maximum total of 30 Sensors can be connected to a Sensor Communications Unit and Distributed Sensor Units.

Communications Specifications

Item	Specifications
Protocol	EtherCAT
Modulation	Baseband
Baud rate	100 Mbps
Physical layer	100Base-TX (IEEE802.3u)
Topology	Daisy chain
Communications media	STP category 5 or higher
Communications distance	100 m max. between nodes
Noise immunity	Compliant with IEC 61000-4-4, 1 kV min.
Node address setting method	Set the decimal rotary switches or software *1
Node address range	000 to 192 *2

*1. The software setting is used when the node address setting switches are set to 0.

*2. The range depend on the EtherCAT master that is used. Refer to the E3NW-ECT EtherCAT Sensor Communications Unit Operation Manual for details.

CompoNet-compatible and CC-Link-compatible products are also available. Refer to your OMRON website for details.

Dimensions

(Unit: mm)
Tolerance class IT16 applies to demmensions in this date sheet unless otherwise specified.

Sensor Communications Unit

77-A E3NW-ECT

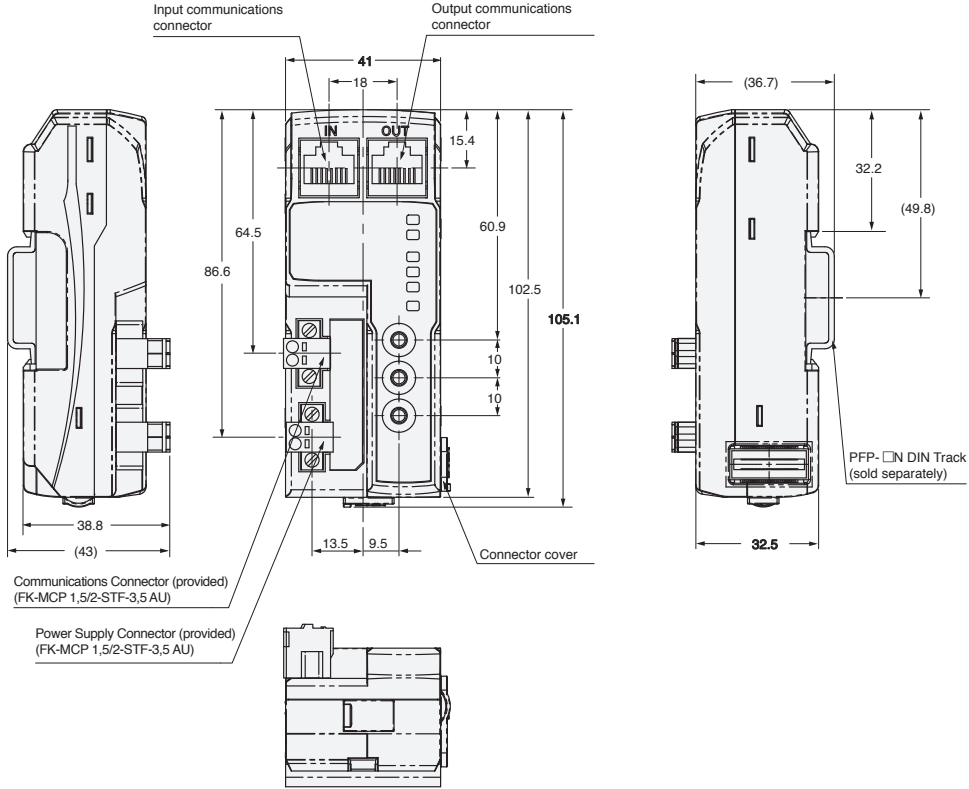

Distributed Sensor Unit

77-B E3NW-DS

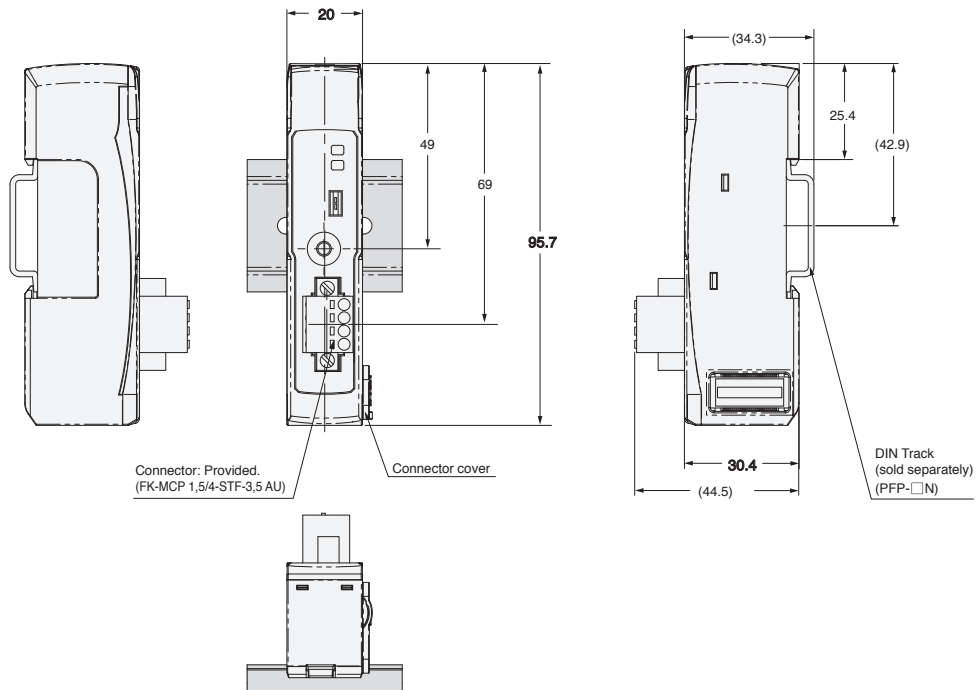

Fiber Sensor Features

Selection Guide

Fiber Units

Threaded	Standard Installation
Cylindrical	
Flat	Saving Space
Sleeved	
Small Spot	Beam Improvements
High Power	
Narrow view	
BGS	Transparent Objects
Retro-reflective	
Limited-reflective	
Chemical-resistant, Oil-resistant	Environmental Immunity
Bending	
Heat-resistant	Applications
Area Detection	
Liquid-level	
Vacuum	FPD, Semi, Solar
FPD, Semi, Solar	

Installation Information

Fiber Amplifiers, Communications Unit, and Accessories

Technical Guide and Precautions

Model Index

- Threaded
- Cylindrical

- Flat
- Sleeved

- Small Spot
- High Power
- Narrow view
- BGS





- Retro-reflective
- Limited-reflective

- Chemical-resistant, Oil-resistant
- Bending
- Heat-resistant



- Area Detection
- Liquid-level
- Vacuum
- FPD, Semi, Solar

E3X-HD Fiber Amplifier Units and Related Products

Fiber Amplifier Units E3X-HD Series

Type	Appearance	Connecting method	Models		Ratings and Specifications	Dimensions
			NPN output	PNP output		
Standard models		Pre-wired (2 m)	E3X-HD11 2M	E3X-HD41 2M	Page 80	Page 80 (80-A)
		Wire-saving Connector	E3X-HD6	E3X-HD8		Page 81 (81-A)
		M8 Connector	E3X-HD14	E3X-HD44		Page 81 (81-B)
Model for Sensor Communications Unit		Connector for Sensor Communications Unit	E3X-HD0			Page 81 (81-C)



Sensor Communications Unit

Communication method	Appearance	Applicable Fiber Amplifier Model	Models	Ratings and Specifications	Dimensions
CompoNet		E3X-HD0 E3X-MDA0 E3X-DA0-S	E3X-CRT	Page 86	Page 87 (87-A)
EtherCAT			E3X-ECT		Page 87 (87-B)

Accessories (sold separately)



Wire-saving connectors (Required for models for Wire-saving Connectors.)

Connectors are not provided with the Fiber Amplifier Unit and must be ordered separately. * Protective stickers: provided.

Type	Appearance	Cable length	Number of conductors	Models	Ratings and Specifications	Dimensions
Master Connector		2m	3	E3X-CN11	Page 88	Page 88 (88-A)
Slave Connector			1	E3X-CN12		Page 88 (88-B)

Sensor I/O Connectors (Required for models with M8 Connectors.)

Connectors are not provided with the Fiber Amplifier Unit and must be ordered separately. * Protective stickers: provided.

Appearance	Cable length	Number of conductors	Models	Ratings and Specifications	Dimensions
Straight 	2m	4	XS3F-M421-402-A	Page 88	Page 88 (88-C)
	5m		XS3F-M421-405-A		
L-shaped 	2m		XS3F-M422-402-A		Page 88 (88-D)
	5m		XS3F-M422-405-A		

Mounting Bracket

A Mounting Bracket is not provided with the Fiber Amplifier Unit and must be ordered separately as required.

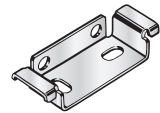
Appearance	Model	Quantity	Dimensions
	E39-L143	1	Page 89 (89-A)

DIN Track

A Din Track is not provided with the Fiber Amplifier Unit and must be ordered separately as required.

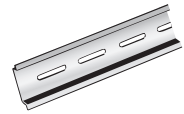
Appearance	Type	Models	Quantity	Dimensions
	Shallow type, total length: 1 m	PFP-100N	1	Page 89 (89-B)
	Shallow type, total length: 0.5 m	PFP-50N		
	Deep type, total length: 1 m	PFP-100N2		Page 89 (89-C)

End Plate

Two End Plates are provided with the Sensor Communications Unit.

End Plates are not provided with the Fiber Amplifier Unit and must be ordered separately as required.

Appearance	Model	Quantity	Dimensions
	PFP-M	1	Page 89 (89-D)

Ratings and Specifications

Item	Type	Standard			Model for Sensor Communications Unit *1
	NPN output	E3X-HD11	E3X-HD6	E3X-HD14	E3X-HD0
	PNP output	E3X-HD41	E3X-HD8	E3X-HD44	
Connecting method	Pre-wired	Wire-saving Connector *2	M8 Connector	Connector for Sensor Communications Unit	
Light source (wavelength)	Red, 4-element LED (625 nm)				
Power supply voltage	12 to 24 VDC ±10%, ripple (P-P) 10% max.			Supplied from the connector through the Sensor Communications Unit	
Power consumption	Normal mode	720 mW max. (Current consumption: 30 mA max. at 24 VDC, 60 mA max. at 12 VDC)			—
	Eco ON	530 mW max. (Current consumption: 22 mA max. at 24 VDC, 44 mA max. at 12 VDC)			
	Eco LO	640 mW max. (Current consumption: 26 mA max. at 24 VDC, 53 mA max. at 12 VDC)			
Control output	Load power supply voltage: 26.4 VDC max., open-collector output Load current: Groups of 1 to 3 Amplifier Units: 100mA max., Groups of 4 to 16 Amplifier Units: 20mA max. Residual voltage: At load current of less than 10 mA: 1 V max., At load current of 10 to 100 mA: 2 V max. OFF current: 0.1mA max.			—	
Protection circuits	Power supply reverse polarity protection, output short-circuit protection and output reverse polarity protection			Power supply reverse polarity protection and output short-circuit protection	
Response time	Super-high-speed mode (SHS) *4	NPN outputs: Operate or reset: 50 μs PNP outputs: Operate or reset: 55 μs			—
	High-speed mode (HS)	Operate or reset: 250 μs (default setting)			
	Standard mode (Std)	Operate or reset: 1 ms			
	Giga-power mode (GIGA)	Operate or reset: 16 ms			
Maximum connectable Units	16 units			with E3X-CRT: 16 units with E3X-ECT: 30 units *3	
Mutual interference prevention	Possible for up to 10 units (optical communications sync) *4				
Auto power control (APC)	Always ON				
Other functions	Power tuning, differential detection, DPC, timer (OFF-delay, ON-delay, or one-shot), zero reset, resetting settings, and Eco mode				
Ambient Illumination (Receiver side)	Incandescent lamp: 20,000 lx max., Sunlight: 30,000 lx max.				
Ambient temperature range	Operating: Groups of 1 to 2 Amplifier Units: -25 to 55°C, Groups of 3 to 10 Amplifier Units: -25 to 50°C, Groups of 11 to 16 Amplifier Units: -25 to 45°C Storage: -30 to 70°C (with no icing or condensation)			Operating: Groups of 1 to 2 Amplifier Units: 0 to 55°C, Groups of 3 to 10 Amplifier Units: 0 to 50°C, Groups of 11 to 16 Amplifier Units: 0 to 45°C, Groups of 17 to 30 Amplifier Units: 0 to 40°C Storage: -30 to 70°C (with no icing or condensation)	
Ambient humidity range	Operating and storage: 35% to 85% (with no condensation)				
Insulation resistance	20 MΩ min. (at 500 VDC)				
Dielectric strength	1,000 VAC at 50/60 Hz for 1 min				
Vibration resistance (destruction)	10 to 55 Hz with a 1.5-mm double amplitude for 2 hours each in X, Y, and Z directions			10 to 150 Hz with a 0.7-mm double amplitude for 80 minutes each in X, Y, and Z directions	
Shock resistance (destruction)	500 m/s ² for 3 times each in X, Y, and Z directions			150 m/s ² for 3 times each in X, Y, and Z directions	
Degree of protection	IEC 60529 IP50 (with Protective Cover attached)				
Weight (packed state/unit only)	Approx. 105 g/Approx. 65 g	Approx. 60 g/Approx. 20 g	Approx. 70 g/Approx. 25 g	Approx. 65 g/Approx. 25 g	
Materials	Case	Polycarbonate (PC)			Heat-resistant ABS (connector: PBT)
	Cover	Polycarbonate (PC)			
Accessories	Instruction Manual				

*1. The E3X-ECT EtherCAT Sensor Communications Unit and the E3X-CRT CompoNet Sensor Communications Unit can be used.

*2. Use either the E3X-CN11 (master connector, 3 conductors) or the E3X-CN12 (slave connector, 1 conductor).

*3. When connected to an OMRON NJ-series Controller.

*4. The communications function and mutual interference prevention function are disabled when the detection mode is set to Super-high-speed mode (SHS).

When including E3X-DA-S with activated power tuning the maximum number of mutual interference prevention is up to 6.

When including E3X-MDA with activated power tuning the maximum number of mutual interference prevention is up to 5.

(Unit: mm)

Dimensions

Tolerance class IT16 applies to demmensions in this date sheet unless otherwise specified.

Pre-wired Amplifier Units

80-A E3X-HD11
E3X-HD41

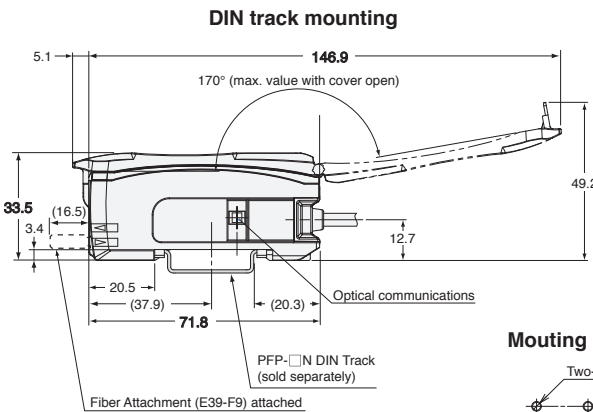
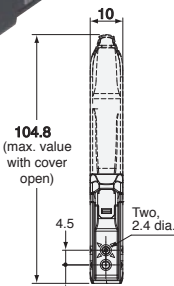
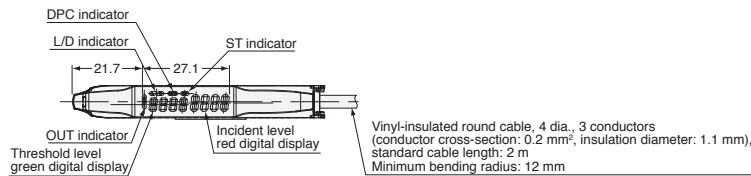

With Mounting Bracket Attached

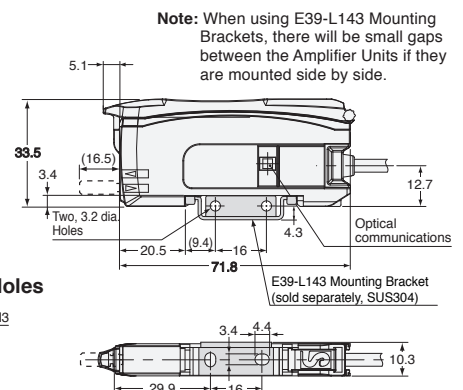

Mounting Holes

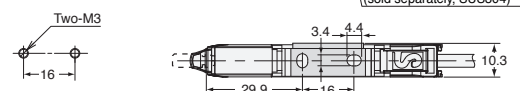

Fiber Sensor Features

Selection Guide

Fiber Units

Standard Installation

Saving Space

Beam Improvements

Transparent Objects

Environmental Immunity

Applications

Installation Information

Fiber Amplifiers, Communications Unit, and Accessories

Technical Guide and Precautions

Model Index

Area Detection

Liquid-level

Vacuum

FPD, Semi, Solar

Amplifier Units with Wire-saving Connectors

81-A E3X-HD6
E3X-HD8

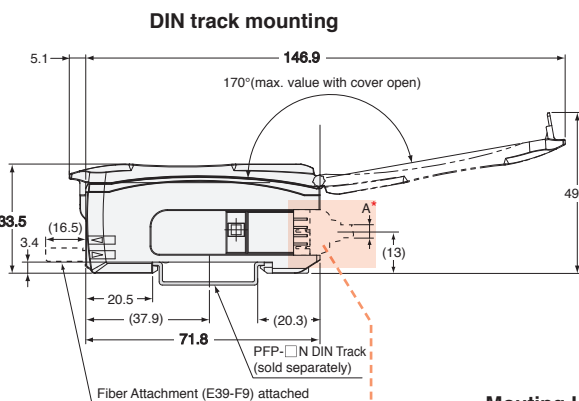
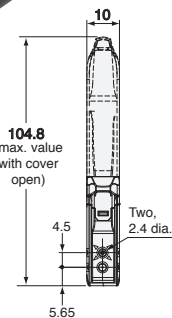
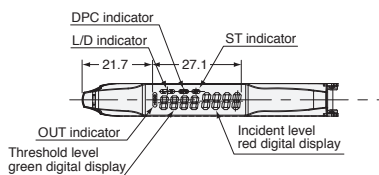

With Mounting Bracket Attached

Note: When using E39-L143 Mounting Brackets, there will be small gaps between the Amplifier Units if they are mounted side by side.

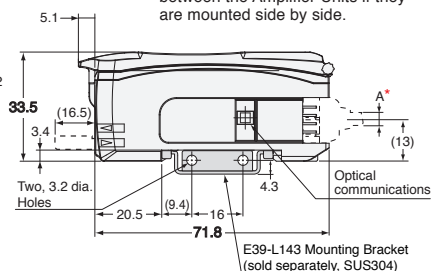

Mouting Holes

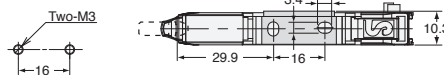

* The cable diameters are as follows:

E3X-CN11 (3 conductors)	4.0 dia.
E3X-CN12 (1 conductor)	2.6 dia.

Amplifier Units with M8 Connectors

81-B E3X-HD14
E3X-HD44

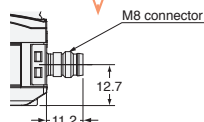

The dimensions are the same as the E3X-HD6/8, except for the connector.

Amplifier Unit with Connector for Sensor Communications Unit

81-C E3X-HD0

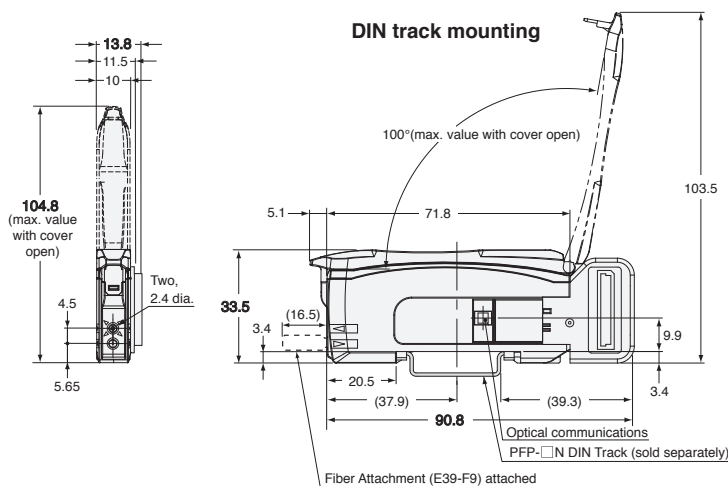
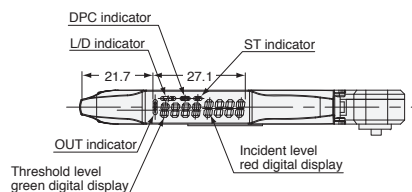

Fiber Sensor Features

Selection Guide

Fiber Units

Threaded	Standard Installation
Cylindrical	
Flat	Saving Space
Sleeved	
Small Spot	Beam Improvements
High Power	
Narrow view	Transparent Objects
BGS	

Retro-reflective	Environmental Immunity
Limited-reflective	
Chemical-resistant, Oil-resistant	Applications
Bending	
Heat-resistant	Installation Information
Area Detection	

Liquid-level	Applications
Vacuum	
FPD, Semi, Solar	Installation Information

Fiber Amplifiers, Communications Unit, and Accessories

Technical Guide and Precautions

Model Index

I/O Circuit Diagrams

NPN Output

Models	Operation mode	Timing chart	L/D indicators	Output circuit
E3X-HD11 E3X-HD6 E3X-HD14	Light-ON	Incident light: [Bar chart showing pulse] No incident light: [Bar chart showing low level] OUT indicator (orange): Lit (orange bar), Not lit (white bar) Output transistor: ON (orange bar), OFF (white bar) Load (e.g., relay): Set (orange bar), Reset (white bar) (Between brown and black leads)	L lit.	<p>• M8 Connector Pin Arrangement</p> <p>Note: Pin 2 is not used.</p>
	Dark-ON	Incident light: [Bar chart showing pulse] No incident light: [Bar chart showing low level] OUT indicator (orange): Lit (orange bar), Not lit (white bar) Output transistor: ON (orange bar), OFF (white bar) Load (e.g., relay): Set (orange bar), Reset (white bar) (Between brown and black leads)	D lit.	

PNP Output

Models	Operation mode	Timing chart	L/D indicators	Output circuit
E3X-HD41 E3X-HD8 E3X-HD44	Light-ON	Incident light: [Bar chart showing pulse] No incident light: [Bar chart showing low level] OUT indicator (orange): Lit (orange bar), Not lit (white bar) Output transistor: ON (orange bar), OFF (white bar) Load (e.g., relay): Set (orange bar), Reset (white bar) (Between blue and black leads)	L lit.	<p>• M8 Connector Pin Arrangement</p> <p>Note: Pin 2 is not used.</p>
	Dark-ON	Incident light: [Bar chart showing pulse] No incident light: [Bar chart showing low level] OUT indicator (orange): Lit (orange bar), Not lit (white bar) Output transistor: ON (orange bar), OFF (white bar) Load (e.g., relay): Set (orange bar), Reset (white bar) (Between blue and black leads)	D lit.	

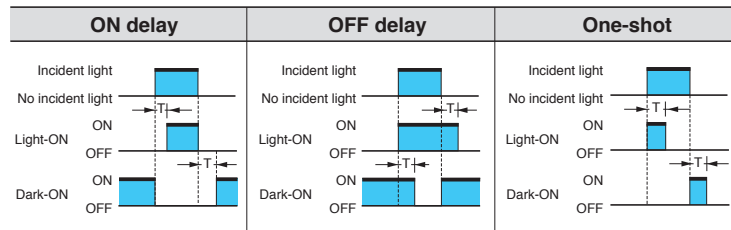

Note: Timing Charts for Timer Settings (T: Set Time)

Plug (Sensor I/O Connector)

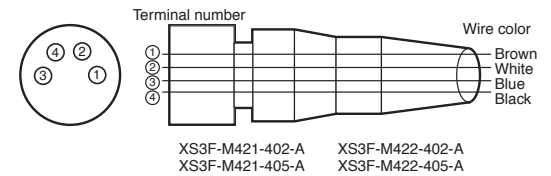

Wire color	Connection pin	Application
Brown	1	Power supply (+V)
White	2	---
Blue	3	Power supply (0 V)
Black	4	Output

Note: Pin 2 is not used.

Nomenclature

- [L/D Indicator]** Indicates the setting status: Light-ON (L) or Dark-ON (D).
- [DPC Indicator]** Turns ON when Dynamic Power Control is effective.
- [OUT Indicator]** Turns ON when the output is ON.
- [ST Indicator]** Turns ON when Smart Tuning is in progress.
- [△L/D Button]** Use to switch between Light-ON (L) and Dark-ON (D).
- [TUNE Button]** Automatically sets the emitter power and set values.
- [MODE Button]** Use to switch between Detection Mode and Setting Mode.
- [+/-UP/DOWN Button]** Used to fine-tune the threshold or change set values.
- Threshold Level** Green digital display
- Incident Level** Red digital display

Operating Procedures

Basic Settings

Output switching

1. Press button.

Through-beam:

Set to "Dark ON" to turn the output ON with a workpiece in the detection area. [L/D Indicator] turns ON.

Reflective:

Set to "Light ON" to turn the output ON with a workpiece in the detection area. [L/D Indicator] turns ON.

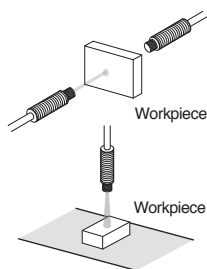

Smart Tuning [Easy Sensitivity Setting]

(1) Detect for Workpiece Presence/Absence

• 2-point Tuning

1. Press button with a workpiece in the detection area.

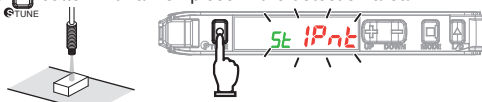

2. Press button again without a workpiece in the detection area.

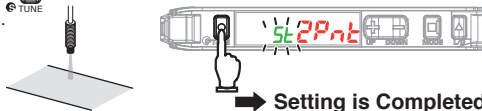

➔ Setting is Completed

Incident light level setting:

The larger incident level of the Step 1 and 2 values is adjusted to the power tuning level. Threshold setting: Set to the middle between the Step 1 and 2 incident light levels.



Step 1 and Step 2 can be reversed.

(2) Enhance Durability of the Fiber Head against Dust and Stain

• Maximum Sensitivity Tuning

1. Hold button for 3 seconds or longer with/without workpiece as shown below.

Release the button when [FULL] is displayed.

Through-beam: Workpiece is present

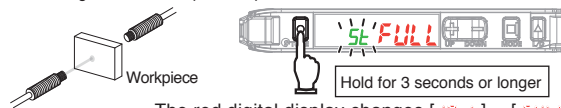

The red digital display changes [1Pnt] → [FULL]

Reflective: Workpiece is absent

➔ Setting is Completed

Incident light level setting:

The incident level in Step 1 is adjusted to "0".

Threshold setting:

The value is set to approx. 7% of the incident light level of 1. If the incident light level of 1 is smaller during long distance detection, the minimum value by which an output is correctly turned ON will be set.

(3) Adjust for Moving Workpiece without Stopping Line

• Full Auto Tuning

1. Hold the button without the presence of a workpiece, and pass the workpiece through while [1Pnt] → [FULL] → [Auto] is displayed in red digital. (Keep holding the button while the workpiece passes through, and hold 7 seconds or longer until [Auto] is displayed in red digital. After the workpiece passes through, release your finger from the button.)

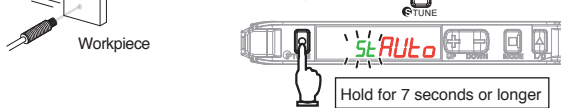

➔ Setting is Completed

Incident light level setting:

Adjust the max. incident light level on Step 1 as the power tuning level.

Threshold setting:

Set to the middle between max. and min. incident light levels on Step 1.

(4) Determine Workpiece Position

• Position Tuning

1. Press button without a workpiece in the area.

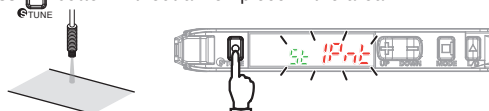

2. Place the workpiece at the desired position and hold button.

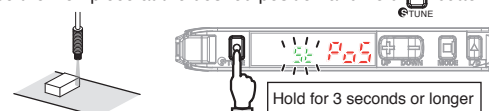

The red digital display changes [2Pnt] → [Pos].

➔ Setting is Completed

Incident light level setting:

The Step 2 incident level is adjusted to half the power tuning level. Threshold setting: Set to the same value as the Step 2 incident level.

(5) Detect Transparent or Small Workpiece (Set Threshold by incident light level percentage)

• Percentage Tuning

1. Turn ON Percentage Tuning in SET mode.

Refer to "Detailed Settings".

2. Press button without a workpiece in the area.



➔ Setting is Completed

Incident light level setting:

The Step 2 incident light level is adjusted to the power tuning level. Threshold setting: Set to the value obtained by [Incident Level at Step 2 × Percentage Tuning Level + Incident Level at Step 2].



No Smart Tuning other than Power Tuning can be used if Percentage Tuning is set.

• Smart Tuning Error

Error / Display / Cause	Error Origin Tuning Type	Remedy
Near Error The light level difference between Points 1 and 2 are extremely small.	2-point Tuning Full Auto Tuning Positioning Tuning	<ul style="list-style-type: none"> Change the detection function mode to a slower response time mode. Reduce the distance between the light emitting and light receiving surfaces. (Through-beam) Place the Fiber Head closer to the sensing object. (Reflective)
Over Error Incident light level is too high.	All	<ul style="list-style-type: none"> Enhance the power tuning level. Use a thin-diameter fiber. Widen the emitter and receiver distance (Through-beam) Distance the Fiber Head from the sensing object (Reflective)
Low Error Incident light level is too low.	Tuning other than Maximum Sensitivity Tuning	<ul style="list-style-type: none"> Decrease the power tuning level. Reduce the distance between the light emitting and light receiving surfaces. (Through-beam) Place the Fiber Head closer to the sensing object. (Reflective)



The adjustment range of smart tuning is approx. 20 to 1/100 times. When selecting giga mode as detection function, the range will be approx. 2 to 1/100 times due to the large initial value.



Refer to "Detailed Settings" to change the power tuning level.

Minute Adjustment of Threshold Level

1. Press button to adjust the threshold level.

The threshold level becomes higher. The threshold level becomes lower.



Hold the key for high-speed level adjustment.

Convenient Setting Features

(1) Restore from the Incident Level Changed due to Dust and Dirt

● Power Tuning

1. Hold and buttons for 1 second or longer without a workpiece in the area.

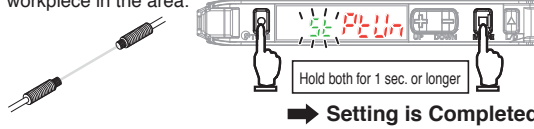

Incident light level setting:
The Step 1 incident level is adjusted to the power tuning level.
Threshold setting:
Not changed. If the value is low, it will be set to the minimum value in which an output is turned ON/OFF correctly.

CHECK! Perform the procedure with a workpiece in the area for reflective model setting. If the setting is made after position tuning, set both the through-beam model and reflective model with a workpiece.

Refer to "Smart Tuning Error" for error displays.

(2) Stable Detection Regardless of Incident Level Change due to Dust and Dirt

● DPC Function (Use of the function with Through-beam model or Retro-reflective model is recommended)

1. Perform Smart Tuning.

Refer to "Smart Tuning"
 Refer to "Power Tuning"

The DPC indicator turns ON when the DPC function is effective.

2. Set the DPC function ON in SET mode.

Refer to "Detailed Settings".

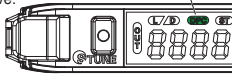

CHECK!
• Steps 1 and 2 can be reversed.
• The DPC function will be disabled when a smart tuning error occurs, differential function with maximum sensitivity tuning is performed, or the first incident light level of the positioning tuning is low.
• The incident light level is corrected to the power tuning level to maintain stable threshold and incident light levels. This provides stable detection regardless of the incident level changes caused by dirty sensor head, position error, or temperature changes.

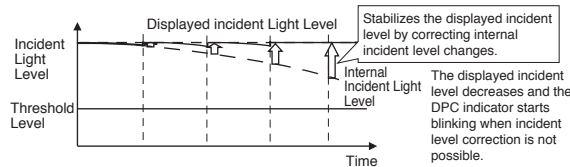

(3) Reset Settings

● Setting Reset

Initializes all the settings by returning them to the factory defaults.

1. Hold button and then hold button for 3 seconds or longer.

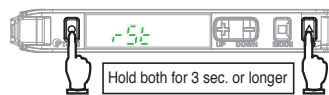

2. Select [**SET**] in and press button.

3. Select [**SET** **FACT**] in and press button.

Item	Initial Value
Threshold Value	55
Control Output	L-ON

* Settings for other functions are returned to the detailed setting initial values. User-saved settings are retained. Smart Tuning is canceled.

CHECK! Caution is required; the output is inverted if button is pressed first.

(4) Save or Read Settings

1. Hold button and then hold button for 3 seconds or longer.

● User Save Function

Saves the current settings.

2. Select [**SAVE**] in and press button.

3. Select [**SAVE YES**] in and press button.

● User Reset Function

Reads out the saved settings.

2. Select [**SET**] in and press button.

3. Select [**SET USER**] in and press button.

CHECK! Caution is required; the output is inverted if button is pressed first.

(5) Prevent Mistake-operation

● Key Lock Function

Disables all button operations. [**LOC ON**] is displayed when the button is pressed.

■ Enable/Cancel (This procedure)

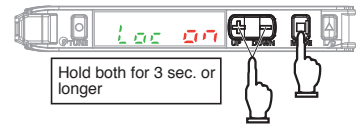

* Press either of UP/DOWN.

(6) Reset Incident Light Level to "0"

● Zero Reset Function

Changes the incident light level to "0". The threshold level is also shifted accordingly.

■ Enable

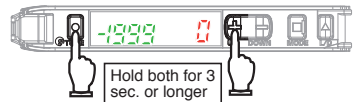

■ Cancel

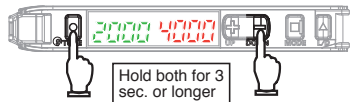

CHECK! The zero reset function is canceled when either of the DPC function/differential function/Smart Tuning is performed.

- Threaded
- Cylindrical

- Flat
- Sleeved

- Small Spot
- High Power
- Narrow view
- BGS

- Retro-reflective
- Limited-reflective

- Chemical-resistant, Oil-resistant
- Bending
- Heat-resistant

- Area Detection
- Liquid-level
- Vacuum
- FPD, Semi, Solar

Detailed Settings

Hold button for 3 seconds or longer to enter SET mode.

SET mode provides the function settings described hereafter. The initial display shown after transition from one function to another represents the factory default.

Function Setting	Description																
1. Function Selection 	Changing Functions to Set in SET Mode [MODE]: Functions 1. to 5. can be set [UP/DOWN]: Functions 1. to 10. can be set.																
2. Detection Function (Incident Light Level Example) (a) (b) (c) (d)	Changing Light Level and Response Time <table border="1"> <thead> <tr> <th>Detection Function</th> <th>Response Time</th> <th>Light Level</th> </tr> </thead> <tbody> <tr> <td>HS High-speed mode</td> <td>250 μs</td> <td>1 (Standard)</td> </tr> <tr> <td>STND Standard mode</td> <td>1 ms</td> <td>1 time</td> </tr> <tr> <td>GIGA Giga mode</td> <td>16 ms</td> <td>12 times</td> </tr> <tr> <td rowspan="2">SHS Super-high-speed mode*</td> <td>NPN 50 μs</td> <td rowspan="2">0.25 times</td> </tr> <tr> <td>PNP 55 μs</td> </tr> </tbody> </table> <p>Smart Tuning is canceled if the detection mode is changed.</p> <p>* The communication and mutual interference prevention functions are disabled when the detection mode is set to super-high-speed mode.</p> <p> CHECK! The incident light level in SET mode is a reference value. It may be changed when switched to detection mode.</p>	Detection Function	Response Time	Light Level	HS High-speed mode	250 μs	1 (Standard)	STND Standard mode	1 ms	1 time	GIGA Giga mode	16 ms	12 times	SHS Super-high-speed mode*	NPN 50 μs	0.25 times	PNP 55 μs
Detection Function	Response Time	Light Level															
HS High-speed mode	250 μs	1 (Standard)															
STND Standard mode	1 ms	1 time															
GIGA Giga mode	16 ms	12 times															
SHS Super-high-speed mode*	NPN 50 μs	0.25 times															
	PNP 55 μs																
3. DPC Function 	Stable Detection Regardless of Incident Light Level Change Refer to "Convenient Setting Features"																
4. Timer Function 	Setting Output Timer <table border="1"> <thead> <tr> <th>Off-delay Timer</th> <th>On-delay Timer</th> <th>One-shot Timer</th> </tr> </thead> <tbody> <tr> <td> Holds the output ON for detection by PLC when the detection time is too short. </td> <td> Delays the output ON after detection. </td> <td> Keeps the output ON for a specified time regardless of the workpiece size variations. </td> </tr> </tbody> </table> <p>A timer value can be set after pressing button when a timer menu (other display than "----") is displayed.</p> <p>Use button to set the time. (1 to 9999 ms in 1 ms steps; the initial value: 10 ms)</p>	Off-delay Timer	On-delay Timer	One-shot Timer	Holds the output ON for detection by PLC when the detection time is too short.	Delays the output ON after detection.	Keeps the output ON for a specified time regardless of the workpiece size variations.										
Off-delay Timer	On-delay Timer	One-shot Timer															
Holds the output ON for detection by PLC when the detection time is too short.	Delays the output ON after detection.	Keeps the output ON for a specified time regardless of the workpiece size variations.															
5. Power Tuning Level 	Changing the Target Incident Light Level (Power Tuning Level) Use button to set the power tuning level. [MODE] to 9999 in 1 steps; the initial value: 9999 Refer to "Convenient Setting Features"																
6. Percentage Tuning 	Detecting Transparent or Small Workpiece Press button in [PER ON] menu, then use button to set the percentage tuning level. (-99% to 99% in 1% steps; the initial value: -10%) Refer to "Smart Tuning"																

Function Setting	Description												
7. Differential Function 	Detecting Incident Light Level Change Detects if the absolute value of the incident light level change of the set response time is larger than the threshold value. The display shows the change of the incident light level of the set response time in red. <table border="1"> <thead> <tr> <th>Differential Setting</th> <th>Response Time</th> </tr> </thead> <tbody> <tr> <td>1</td> <td>250 μs</td> </tr> <tr> <td>2</td> <td>500 μs</td> </tr> <tr> <td>3</td> <td>1 ms</td> </tr> <tr> <td>4</td> <td>10 ms</td> </tr> <tr> <td>5</td> <td>100 ms</td> </tr> </tbody> </table> <p>Use button to specify the response time.</p> <p>When the differential function is enabled, the detection function setting is disabled.</p> <p>Smart tunings except power tuning are disabled.</p> <p>The adjustment range of power tuning is approx. 1 to 1/100 times.</p>	Differential Setting	Response Time	1	250 μs	2	500 μs	3	1 ms	4	10 ms	5	100 ms
Differential Setting	Response Time												
1	250 μs												
2	500 μs												
3	1 ms												
4	10 ms												
5	100 ms												
8. Digital Display 	Changing Digital Display in RUN Mode for Specific Purpose <table border="1"> <thead> <tr> <th>Setting</th> <th>Description</th> </tr> </thead> <tbody> <tr> <td>(a) </td> <td>Checking a Margin Against Threshold Threshold Light Level Ratio (a) The ratio of the incident light level to the threshold is displayed in red digital figures.</td> </tr> <tr> <td>(b) </td> <td>Setting Threshold using a Small or Fast Moving Workpiece Peak Light Level Bottom Light Level (b) Holds and displays the minimum value of the peak of the light incident and the maximum value of the bottom of the light interruption.</td> </tr> <tr> <td>(c) </td> <td>Setting for Intuitive Analog Display Threshold 120% 100% 80% (c) Displays the current level in the 80 to 120% range against the threshold value (100%).</td> </tr> <tr> <td>(d) </td> <td>Adjusting Optical Axis Peak Light Level Light Level (d) Holds the peak incident light level and displays it in green digital figures.</td> </tr> <tr> <td>(e) </td> <td>Checking the Channel No. in Group Mounting Ch. No. Light Level (e) Checking the Channel No. in Group Mounting.</td> </tr> </tbody> </table>	Setting	Description	(a)	Checking a Margin Against Threshold Threshold Light Level Ratio (a) The ratio of the incident light level to the threshold is displayed in red digital figures.	(b)	Setting Threshold using a Small or Fast Moving Workpiece Peak Light Level Bottom Light Level (b) Holds and displays the minimum value of the peak of the light incident and the maximum value of the bottom of the light interruption.	(c)	Setting for Intuitive Analog Display Threshold 120% 100% 80% (c) Displays the current level in the 80 to 120% range against the threshold value (100%).	(d)	Adjusting Optical Axis Peak Light Level Light Level (d) Holds the peak incident light level and displays it in green digital figures.	(e)	Checking the Channel No. in Group Mounting Ch. No. Light Level (e) Checking the Channel No. in Group Mounting.
Setting	Description												
(a)	Checking a Margin Against Threshold Threshold Light Level Ratio (a) The ratio of the incident light level to the threshold is displayed in red digital figures.												
(b)	Setting Threshold using a Small or Fast Moving Workpiece Peak Light Level Bottom Light Level (b) Holds and displays the minimum value of the peak of the light incident and the maximum value of the bottom of the light interruption.												
(c)	Setting for Intuitive Analog Display Threshold 120% 100% 80% (c) Displays the current level in the 80 to 120% range against the threshold value (100%).												
(d)	Adjusting Optical Axis Peak Light Level Light Level (d) Holds the peak incident light level and displays it in green digital figures.												
(e)	Checking the Channel No. in Group Mounting Ch. No. Light Level (e) Checking the Channel No. in Group Mounting.												
9. Inverted Display 	Mounting Amplifier in Inverted Direction Inverts the display upside down. The digital display shows the threshold value in red, and light incident level in green.												
10. Eco Function 	Saving Power Consumption Eco on Indicators (Green and Red digital displays) turn OFF in approx. 10 seconds after a key operation. Eco Lo Indicators (Green and Red digital displays) turn ON with low brightness in approx. 10 seconds after a key operation.												

Ratings and Specifications

E3X-CRT

Item	Specifications
Communication method	CompoNet Communications
Connectable Sensors	Fiber Sensors: E3X-HD0, E3X-MDA0 and E3X-DA0-S Laser Sensor Head with Separate Digital Amplifier: E3C-LDA0 Proximity Sensor with Separate Amplifier: E2C-EDA0
Communications power supply voltage	14 to 26.4 VDC (Communications Unit draws power from the communications power supply.)
Power and current consumption	2.4 W max. (Not including the power supplied to Sensor.) 100 mA max. at 24 VDC (Not including the current supplied to Sensor.)
Functions	I/O communications, message communications, and Sensor error output
Indicators	MS Indicator (Green/Red), NS indicator (Green/Red), and SS (Sensor Status) indicator (Green/Red)
Vibration resistance	10 to 150 Hz with double amplitude of 0.7 mm, or 50 m/s ² 80 min each in X, Y, and Z directions
Shock resistance	150 m/s ² 3 times each in X, Y, and Z directions
Dielectric strength	500 VAC 50/60Hz 1 min
Insulation resistance	20MΩ min.
Ambient operating temperature	0 to 55°C (with no icing or condensation) * The temperature is limited by the number of connected Fiber Amplifier Units.
Ambient operating humidity	25% to 85% (with no icing or condensation)
Storage temperature	-30 to 70°C (with no icing or condensation)
Storage humidity	25% to 85% (with no condensation)
Mounting method	35-mm DIN track-mounting
Weight (packed state/unit only)	Approx. 220 g/Approx. 95 g
Accessories	Connector cover, DIN track End Plates and Instruction manual

Note. The E3X-CRT has two operating modes: I/O mode 1 and I/O mode 2. The following table gives the differences between these modes.

	I/O classification	Number of allocated points	Maximum number of interconnected
I/O mode 1	Input Unit	Input: 32	15
I/O mode 2	I/O Unit	Input: 64 Output: 64	16

* Temperature Limitations Based on Number of Connected Fiber Amplifier Units:
Groups of 1 to 2 Amplifier Units: 0 to 55°C,
Groups of 3 to 10 Amplifier Units: 0 to 50°C,
Groups of 11 to 16 Amplifier Units: 0 to 45°C

Read the User's Manual for precautions on using this Unit. (E412)

E3X-ECT

Item	Specifications
Communication method	EtherCAT
Connectable Sensors	Fiber Sensor: E3X-HD0, E3X-MDA0 and E3X-DA0-S Laser Sensor Head with Separate Digital Amplifier: E3C-LDA0 Proximity Sensor with Separate Amplifier: E2C-EDA0
Power supply voltage	20.4 to 26.4 VDC
Power and current consumption	2.4 W max. (Not including power the supplied to Sensor.) 100 mA max. at 24 VDC (Not including the current supplied to Sensor.)
Functions	DC (synchronous) mode, Free run mode, PDO communications,* 1 SDO communications, Sensor error output
Indicators	L/A IN indicator (Yellow), L/A OUT indicator (Yellow), PWR indicator (Green), RUN indicator (Green), ERROR indicator (Red), and SS (Sensor Status) indicator (Green/Red)
Vibration resistance	10 to 150 Hz with double amplitude of 0.7 mm, or 50 m/s ² 80 min each in X, Y, and Z directions
Shock resistance	150 m/s ² 3 times each in X, Y, and Z directions
Dielectric strength	500 VAC 50/60 Hz 1 min
Insulation resistance	20MΩ min.
Ambient operating temperature	0 to 55°C (with no icing or condensation) * The temperature is limited by the number of connected Fiber Amplifier Units.
Ambient operating humidity	25% to 85% (with no condensation)
Storage temperature	-30 to 70°C (with no icing or condensation)
Storage humidity	25% to 85% (with no condensation)
Mounting method	35-mm DIN track-mounting
Weight (packed state/unit only)	Approx. 220 g/Approx. 95 g
Accessories	Power supply connector, connector cover, DIN track End Plates and Instruction manual

*1. Data Size Assignable to the PDO (Process Data Object):
There is a maximum data size that can be assigned. The maximum size is 36 bytes.
*2. Temperature Limitations Based on Number of Connected Fiber Amplifier Units:
Groups of 1 to 2 Amplifier Units: 0 to 55°C,
Groups of 3 to 10 Amplifier Units: 0 to 50°C,
Groups of 11 to 16 Amplifier Units: 0 to 45°C,
Groups of 17 to 30 Amplifier Units: 0 to 40°C

Read the User's Manual for precautions on using this Unit. (E413)

Dimensions

(Unit: mm)

Tolerance class IT16 applies to demmensions in this date sheet unless otherwise specified.

87-A E3X-CRT

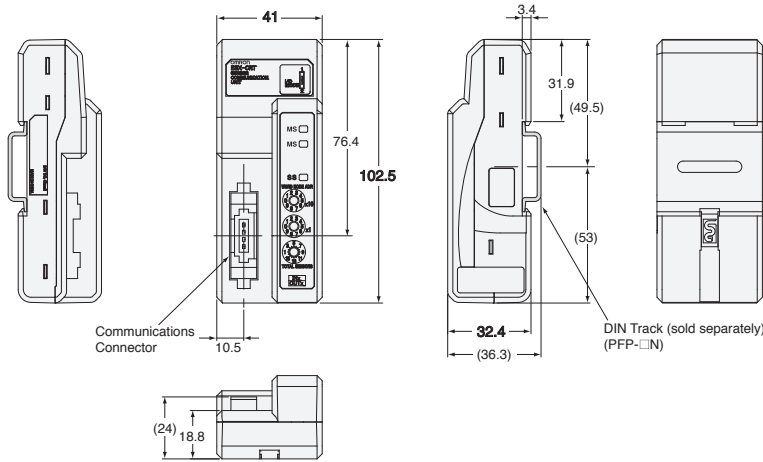

87-B E3X-ECT

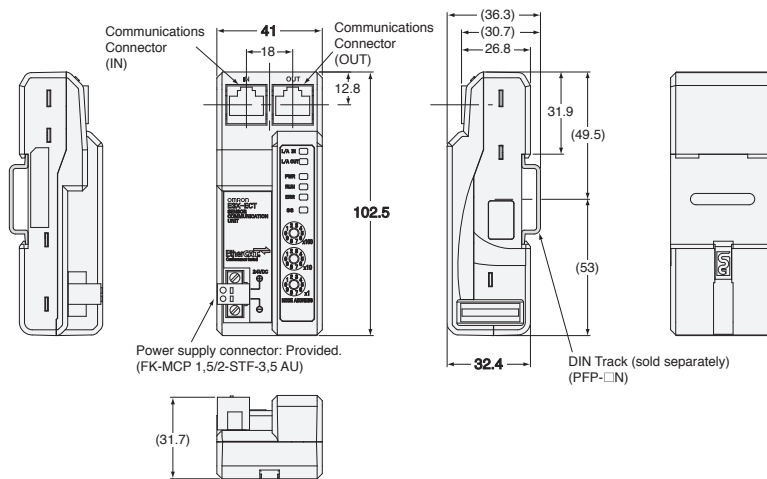

Fiber Sensor Features

Selection Guide

Fiber Units

Threaded	Standard Installation
Cylindrical	
Flat	Saving Space
Sleeved	
Small Spot	Beam Improvements
High Power	
Narrow view	
BGS	Transparent Objects
Retro-reflective	
Limited-reflective	
Chemical-resistant, Oil-resistant	Environmental Immunity
Bending	
Heat-resistant	
Area Detection	Applications
Liquid-level	
Vacuum	
FPD, Semi, Solar	

Installation Information

Fiber Amplifiers, Communications Unit, and Accessories

Technical Guide and Precautions

Model Index

Ratings and Specifications

Wire-saving Connectors

Item	Type	Master Connector		Slave Connector	
	Models	E3X-CN21	E3X-CN11	E3X-CN22	E3X-CN12
Number of conductors		4	3	2	1
Diameter of cable		4 dia.			2.6 dia.
Rated current		2.5A			
Rated voltage		50VDC			
Contact resistance		20 mΩ max. (20 mVDC max., 100 mA max.) (The above figure is for connection to the Amplifier Unit and the adjacent Connector. It does not include the conductor resistance of the cable.)			
Number of insertions		Destruction: 50 times (for connection to the Amplifier Unit and the adjacent Connector)			
Material	Housing	Polybutylene terephthalate (PBT)			
	Contact	Phosphor bronze/gold-plated nickel			
Weight (packed state)		Approx. 55 g		Approx. 25 g	

Sensor I/O Connectors

Item	Models	XS3F-M42□-40□-A
Number of conductors		4
Diameter of cable		4 dia.
Rated current		1A
Rated voltage		125VDC
Contact resistance		40 mΩ max. (20 mVDC max., 100 mA max.)
Number of insertions		Destruction: 200 times

Threaded

Cylindrical

Flat

Sleeved

Small Spot

High Power

Narrow view

BGS

Retro-reflective

Limited-reflective

Chemical-resistant, Oil-resistant

Bending

Heat-resistant

Area Detection

Liquid-level

Vacuum

FPD, Semi, Solar

Dimensions

Tolerance class IT16 applies to demmensions in this date sheet unless otherwise specified.

Wire-saving Connectors (for Models with Wire-saving Connectors)

Master Connector

88-A E3X-CN21
E3X-CN11

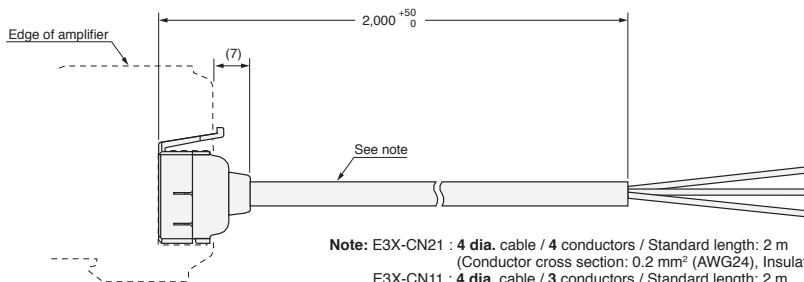

Note: E3X-CN21 : 4 dia. cable / 4 conductors / Standard length: 2 m
(Conductor cross section: 0.2 mm² (AWG24), Insulator diameter: 1.1 mm)
E3X-CN11 : 4 dia. cable / 3 conductors / Standard length: 2 m
(Conductor cross section: 0.2 mm² (AWG24), Insulator diameter: 1.1 mm)

Slave Connector

88-B E3X-CN22
E3X-CN12

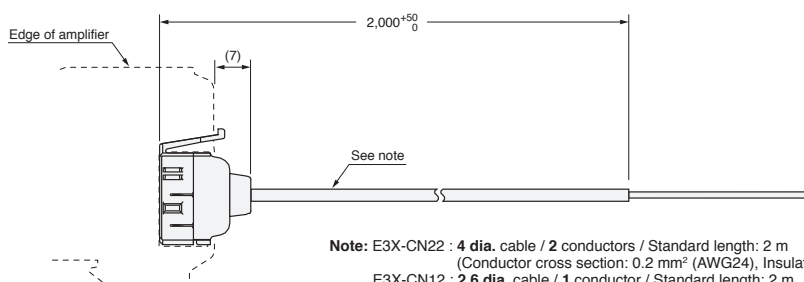
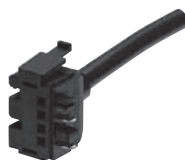

Note: E3X-CN22 : 4 dia. cable / 2 conductors / Standard length: 2 m
(Conductor cross section: 0.2 mm² (AWG24), Insulator diameter: 1.1 mm)
E3X-CN12 : 2.6 dia. cable / 1 conductor / Standard length: 2 m
(Conductor cross section: 0.2 mm² (AWG24), Insulator diameter: 1.1 mm)

Sensor I/O Connectors (for Models with M8 Connectors)

88-C XS3F-M421-402-A
XS3F-M421-405-A

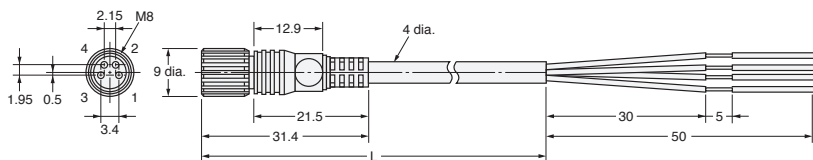

88-D XS3F-M422-402-A
XS3F-M422-405-A

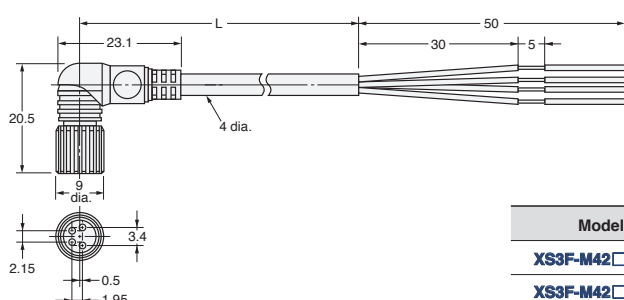

Models	Cable length L (m)
XS3F-M42□-402-A	2
XS3F-M42□-405-A	5

Mounting Brackets

89-A E39-L143

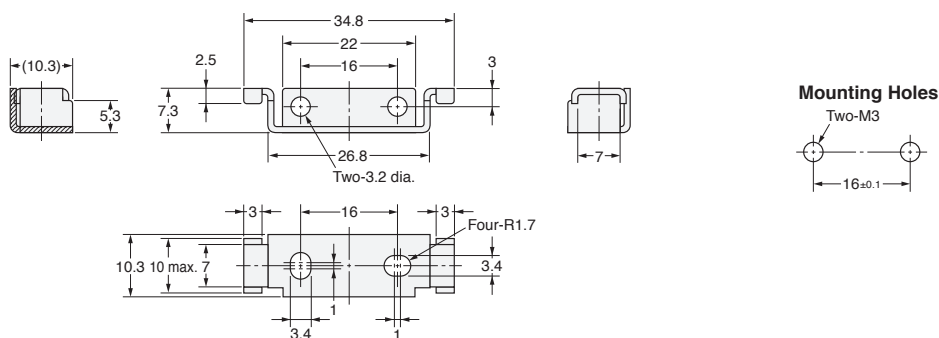
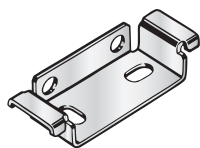

Material: Stainless steel (SUS304)

DIN track

89-B PFP-100N
PFP-50N

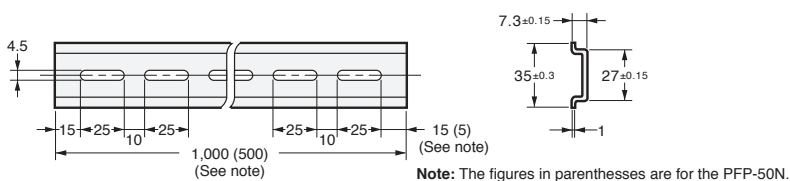

Material: Aluminum

89-C PFP-100N2

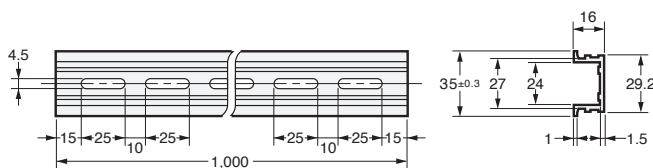

Material: Aluminum

End Plate

89-D PFP-M

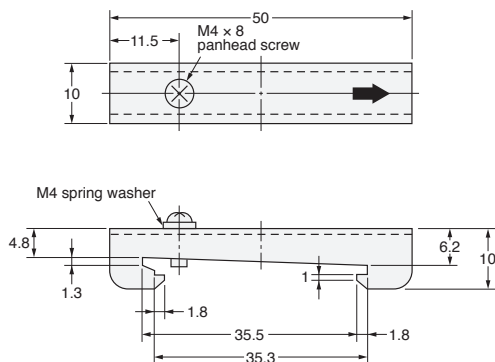

Material: Iron, zinc plating

Fiber Sensor Features

Selection Guide

Fiber Units

Threaded	Standard Installation
Cylindrical	
Flat	Saving Space
Sleeved	
Small Spot	Beam Improvements
High Power	
Narrow view	
BGS	Transparent Objects
Retro-reflective	
Limited-reflective	
Chemical-resistant, Oil-resistant	Environmental Immunity
Bending	
Heat-resistant	
Area Detection	Applications
Liquid-level	
Vacuum	
FPD, Semi, Solar	Installation Information

Fiber Amplifiers, Communications Unit, and Accessories

Technical Guide and Precautions

Model Index

Reference Information for Fiber Units

Influence of Fiber Cable Length

The sensing distance listed in the Fiber Units specifications are based on the fiber cable lengths found in the suffix of the model number. The sensing distance will change if the fiber cable is cut or extended. The following graph shows the percentage change of the various fiber cable length, where 100% is the sensing distance for a fiber cable with a length of 2 m. Use this as a guideline for installation distances. Keep in mind that extending the cable with a fiber connector will result in even shorter sensing distances than the value given in the graph.

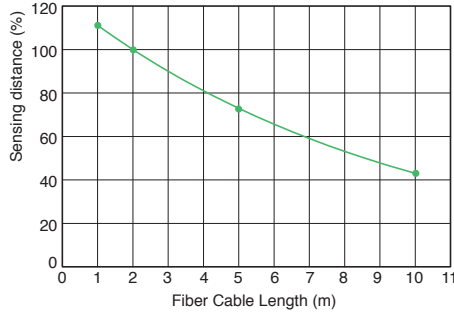

* The 100% value is for a fiber cable with a length of 2 m (same for Through-beam and Reflective Models).

Reflective Models: Sensing Distance Ratios by Workpiece Materials

The following graph shows the percentage change of the various workpieces, where 100% is the sensing distance for white paper, the standard sensing object. Refer to the value of the material that looks like your workpiece.

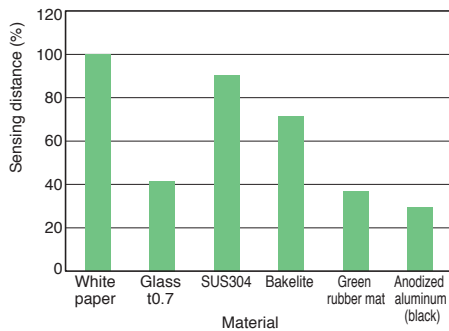

* White paper is 100%.

Types of Fiber Cables

This section describes the features of different types of fiber cables. (This is given in the Fiber Unit specifications as either Flexible or Bend-resistant for the cable bending radius, and Coaxial for the appearance. If no definition is given, a standard cable is used.)

• Flexible Fibers

The flexible fiber has a small bending radius for easy routing without easily breaking. It is easy to use because the cable can be bent without significantly reducing light intensity.

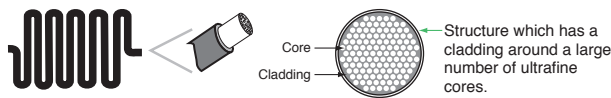

• Break-resistant Fibers

This fiber is resistant to repeated bends for use on moving parts.

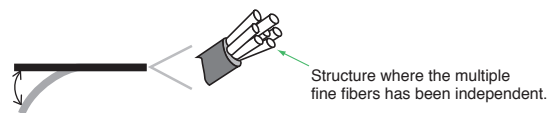

• Standard Fibers

This fiber have a large bending radius compared with bend-resistant or flexible fiber. Use this fiber where the bending radius is large, or on non-moving parts.

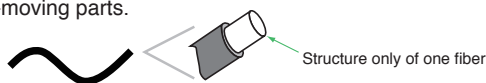

• Coaxial Reflective Fibers

These fibers are suitable for sensing small objects at close range.

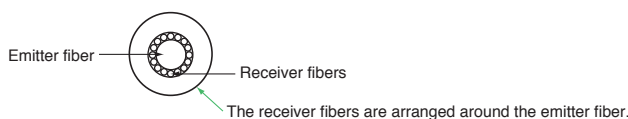

- Fiber Sensor Features
- Selection Guide
- Fiber Units
 - Standard Installation
 - Threaded
 - Cylindrical
 - Saving Space
 - Flat
 - Sleeved
 - Beam Improvements
 - Small Spot
 - High Power
 - Narrow view
 - BGS
 - Transparent Objects
 - Retro-reflective
 - Limited-reflective
 - Environmental Immunity
 - Chemical-resistant, Oil-resistant
 - Bending
 - Heat-resistant
 - Applications
 - Area Detection
 - Liquid-level
 - Vacuum
 - FPD, Semi, Solar
 - Installation Information
- Fiber Amplifiers, Communications Unit, and Accessories

Q&A

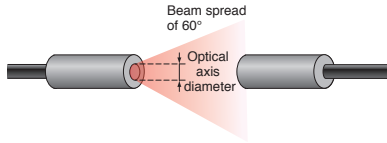
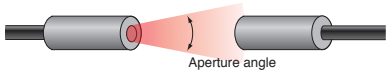
Category	Question	Answer
Fiber Units	How do I interpret the optical axis diameter in the Fiber Unit specifications?	<p>The optical axis diameter is the beam size that the Through-beam Fiber Unit uses for detection.</p> <p>If you are detecting objects larger than the optical axis diameter, you can expect stable detection performance because the object will block all of the beams of light that are used for detection.</p> <p>The incident level may fluctuate, however, if the workpiece passes the beam at high speed.</p> <p>In this case, it is best to select a Fiber Unit with a smaller optical axis diameter, or change the response time of the Fiber Amplifier Unit to High-speed mode or to Super-high-speed mode setting.</p> 
	Are there any differences between the Fiber Units that are used for emitter and receiver?	<p>With Through-beam Fiber Units, there is no difference between emitter fibers and receiver fibers.</p> <p>With Reflective Fiber Units, the emitter fibers and receiver fibers are different on Coaxial Reflective Models.</p> <p>Emitter fiber cables have identification marks. Refer to the individual dimensions diagrams of Fiber Units for details.</p>
	What size must the hole be to mount a Threaded or Cylindrical Fiber Unit?	Refer to the recommended mounting hole dimensions given on pages 58 to 61.
	Are Fiber Cables available in different lengths?	Some models are available with either 5-m or 10-m cable. Ask your OMRON representative for details.
	What is the aperture angle?	<p>The aperture angle is the angle at which the emitter beam spreads out.</p> 
	Are these Fiber Units CE certified?	Fiber Units do not have any electrical components and therefore are exempt from CE certification.
	Can these Fiber Units be used in explosionproof areas?	The Fiber Units can be used in an explosion-proof area. Install only the Fiber Unit in the explosion-proof area and install the Fiber Amplifier Unit outside the explosion-proof area.
Fiber Amplifier Units	Can the Fiber Amplifier Units be linked with other models?	The E3X-HD Series can be connected only with the E3X-DA-S and MDA Series.
	Can the Fiber Amplifier Unit be operated from a mobile console?	Mobile consoles cannot be used with either the E3NX-FA Series or the E3X-HD Series.
	Can a Sensor Communications Unit be used?	<p>If you use E3NX-FA0 Amplifier Units, you can use the E3NW-ECT(EtherCAT), E3NW-CRT(CompoNet) or E3NW-CCL(CC-Link).</p> <p>If you use E3X-HD0 Amplifier Units, you can use the E3X-CRT(CompoNet) or E3X-ECT(EtherCAT).</p>

Fiber Sensor Features

Selection Guide

Fiber Units

Threaded	Standard Installation
Cylindrical	
Flat	Saving Space
Sleeved	
Small Spot	Beam Improvements
High Power	
Narrow view	
BGS	Transparent Objects
Retro-reflective	
Limited-reflective	
Chemical-resistant, Oil-resistant	Environmental Immunity
Bending	
Heat-resistant	
Area Detection	Applications
Liquid-level	
Vacuum	
FPD, Semi, Solar	Installation Information

Fiber Amplifiers, Communications Unit, and Accessories

Technical Guide and Precautions

Model Index

Threaded

Cylindrical

Flat

Sleeved

Small Spot

High Power

Narrow
view

BGS

Retro-
reflectiveLimited-
reflectiveChemical-
resistant,
Oil-resistant

Bending

Heat-
resistantArea
Detection

Liquid-level

Vacuum

FPD,
Semi,
Solar

For common precautions, refer to www.ia.omron.com

Fiber Amplifier Unit

Warning

This product is not designed or rated for ensuring safety of persons either directly or indirectly. Do not use it for such purposes.



Do not use the product with voltage in excess of the rated voltage. Excess voltage may result in malfunction or fire.



Never use the product with AC power supply. Otherwise, explosion may result.



Precautions for Safe Use

The following precautions must be observed to ensure safe operation of the product. Doing so may cause damage or fire.

- (1) Do not install the product in the following locations.
 - Locations subject to direct sunlight
 - Locations subject to condensation due to high humidity
 - Locations subject to corrosive gas
 - Locations subject to vibration or mechanical shocks exceeding the rated values
 - Locations subject to exposure to water, oil, chemicals
 - Locations subject to stream
 - Locations subjected to strong magnetic field or electric field
- (2) Do not use the product in environments subject to flammable or explosive gases.
- (3) Do not use the product in any atmosphere or environment that exceeds the ratings.
- (4) To secure the safety of operation and maintenance, do not install the product close to high-voltage devices and power devices.
- (5) High-Voltage lines and power lines must be wired separately from this product. Wiring them together or placing them in the same duct may cause induction, resulting in malfunction or damage.
- (6) Do not apply load exceeding the ratings. Otherwise, damage or fire may result.
- (7) Do not short the load. Otherwise, damage or fire may result.
- (8) Connect the load correctly.
- (9) Do not miswire such as the polarity of the power supply.
- (10) Do not use the product if the case is damaged.
- (11) Burn injury may occur. The product surface temperature rises depending on application conditions, such as the ambient temperature and the power supply voltage. Attention must be paid during operation or cleaning.
- (12) When setting the Sensor, be sure to check safety, such as by stopping the equipment.
- (13) Be sure to turn off the power supply before connecting or disconnecting wires.
- (14) Do not attempt to disassemble, repair, or modify the product Unit in any way.
- (15) When disposing of the product, treat it as industrial waste.
- (16) Do not use the Sensor in water, rain, or outdoors.

Precautions for Correct Use

- (1) Be sure to mount the unit to the DIN track until it clicks.
- (2) When using Amplifier Units with Wire-saving Connectors, attach the protective stickers (provided with E3X-CN-series Connectors) on the unused power pins to prevent electrical shock and short circuiting. When using Amplifier Units with Connectors for Communications Units, attach the protective caps (provided with Sensor Communications Unit).

Amplifier Unit with Wire-saving Connector

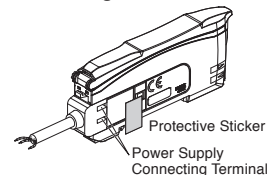

Amplifier Unit with Connector for Communications Unit

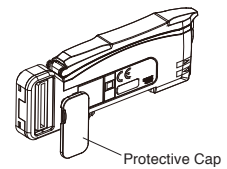

- (3) Use an extension cable with a minimum thickness of 0.3 mm² and less than 100 m long.
- (4) Do not apply the forces on the cord exceeding the following limits: Pull: 40N; torque: 0.1N·m; pressure: 20N; bending: 29.4N
- (5) Do not apply excessive force such as tension, compression or torsion to the Amplifier Unit with the Fiber Unit fixed to the Amplifier Unit.
- (6) Always keep the protective cover in place when using the Amplifier Unit. Not doing so may cause malfunction.
- (7) It may take time until the received light intensity and measured value become stable immediately after the power is turned on depending on use environment.
- (8) The product is ready to operate 200 ms after the power supply is turned ON.
- (9) The Mobile Console E3X-MC11, E3X-MC11-SV2 and E3X-MC11-S cannot be connected.
- (10) Mutual interference prevention on the E3NX-FA Series does not function among the E3X-HD, E3X-DA-S, E3X-DA-N, E3X-SD, or E3X-NA Fiber Amplifier Units. Mutual interference prevention on the E3X-HD Series does not function among the E3NX-FA, E3X-DA-N, E3X-SD, or E3X-NA Fiber Amplifier Units. Mutual interference prevention on the E3X-HD Series does function among the E3X-DA-S and E3X-MDA Fiber Amplifier Units.
- (11) If the unit receives excessive sensor light, the mutual interference prevention function may not work properly, resulting in malfunction of the unit. In such case, increase the threshold.
- (12) The E3NW-ECT Sensor Communications Unit can be used with the E3NX-FA0, but the E3X-DRT21-S, E3X-CRT, and E3X-ECT Sensor Communications Units cannot be used. The E3X-CRT and E3X-ECT Sensor Communications Unit can be used with the E3X-HD0, but the E3X-DRT21-S and E3NW-ECT Sensor Communications Units cannot be used.
- (13) If you notice an abnormal condition such as a strange odor, extreme heating of the unit, or smoke immediately stop using the product, turn off the power, and consult your dealer.
- (14) Do not use thinner, benzene, acetone, and lamp oil for cleaning.

Threaded	Standard Installation
Cylindrical	
Flat	Saving Space
Sleeved	
Small Spot	Beam Improvements
High Power	
Narrow view	
BGS	Transparent Objects
Retro-reflective	
Limited-reflective	
Chemical-resistant, Oil-resistant	
Bending	Environmental Immunity
Heat-resistant	
Area Detection	
Liquid-level	Applications
Vacuum	
FPD, Semi, Solar	

Mounting the Fiber Amplifier Units

Mounting on DIN Track

- Let the hook on the Amplifier Unit's Fiber Unit connection side catch the track and push the unit until it clicks.

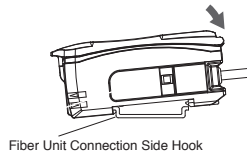

Removing from DIN Track

- Push the unit in the direction 1.
- Lift it up in the direction 2.

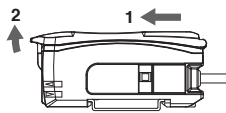

Refer to "I/O Circuit Diagrams" or check the side of the unit for wire color and role indications.

Mounting Amplifier Units in Group (Wire-saving Connector Type Models)

- Mount the Fiber Amplifier units one at a time onto the DIN track and push them until they click.
- Slide the Fiber Amplifier units in the direction 2.
- Use End Plates (PFP-M: separately sold) at the both ends of the grouped Fiber Amplifier units to prevent them from separating due to vibration or other cause.
- Tighten the screw on the End Plates using a driver.

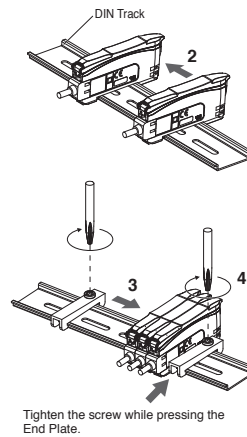

- Under environments such as vibration, use an end plates even with a single Fiber Amplifier Unit.
- The maximum numbers of connectable Amplifier Units are given in the following table.

	Maximum number of interconnected	Maximum number of mutual interference prevention
E3NX-FA series*	30	10
E3X-HD series standard models* (E3X-HD11/HD41/HD6/HD8)	16	10
E3X-HD0	With E3X-ECT	30
	With E3X-CRT	16

- If Units are to be connected, the ambient temperature will change with the number of Units that are connected. Check the Ratings and Characteristics specifications.
- Always turn OFF the power before connecting or disconnecting Units.
- * The mutual interference prevention function cannot be used if the detection mode is set to super-high-speed mode (SHS).

Mounting Fiber Units

Use Fiber Cutter

Cut a thin fiber as follows. For standard fibers, insert to the desired cutting position and cut.

(1) The fiber is shipped loosely tightened as shown in the figure at the right	
(2) Adjust the fiber to the desired length and fully tighten.	
(3) Insert the Fiber Unit into E39-F4 and cut it.	
(4) Finished state. (Correctly cut end)	

Note: The insertion direction into the Fiber Amplifier Unit is shown in the above figure.

Mount Fiber Unit

- Open the protective cover.
- Raise the lock lever.
- Insert the Fiber Unit in the fiber unit hole to the bottom.
- Return the lock lever to the original position and fix the Fiber Unit.

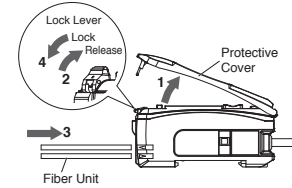

- When mounting a coaxial reflective Fiber Unit, insert the single-core Fiber Unit to the upper hole (Emitter side) and the multi-core Fiber Unit to the lower hole (Receiver side). The cables for the Single-core Fiber Units (Emitters) have identification marks. Refer to the dimensions diagrams for details.

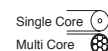

- When removing the Fiber Unit, follow the above steps in reverse order. To maintain the characteristics of the Fiber Unit, make sure the lock is released before removing the Fiber Unit.

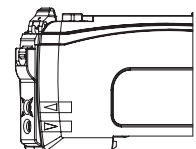

Threaded
Cylindrical

Flat
Sleeved

Small Spot
High Power
Narrow view

Retro-reflective
Limited-reflective

Chemical-resistant, Oil-resistant
Bending
Heat-resistant

Area Detection
Liquid-level
Vacuum
FPD, Semi, Solar

Fiber Units

Warning

This product is not designed or rated for ensuring safety of persons either directly or indirectly. Do not use it for such purposes.



Precautions for Correct Use

Do not use the Fiber Unit in atmospheres or environments that exceed product ratings.

Mounting

Tightening Force

Refer to pages 56 to 59 for the tightening torque to apply when mounting a Fiber Unit.

<Threaded Models>

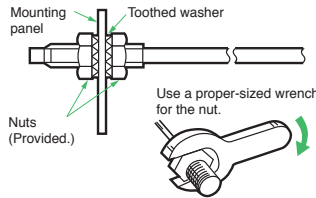

<Cylindrical Models>

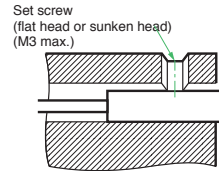

<Chemical and Oil-resistant Models>

The following method is recommended for mounting Fiber Units with fluororesin-covered sensing heads (E32-T□F and E32-D□F) to prevent from cracking the fluororesin case.

If you use a set screw to secure the Fiber Unit, tighten it with care to prevent from cracking the case.

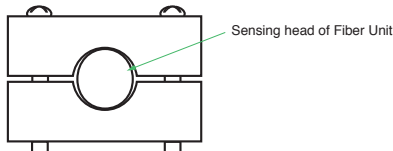

Connections

- Do not subject the Fiber Unit to excessive force, such as tension or compression. Refer to pages 56 to 59 for tensile strengths.
- Make sure any bend in the Fiber Unit is larger than the allowable bending radius. Refer to pages 56 to 59 for bending radius ratings and length of unbendable sections at the base of the Fiber Unit.
- Do not compress or place heavy loads on the fibers.

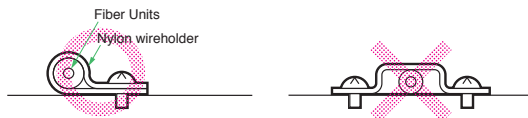

- The method shown below is an effective way to prevent the Fiber Unit from breaking due to vibration.

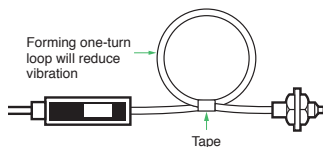

Sleeve Bender (E39-F11)

- The bending radius of the stainless steel tube should be as large as possible. The smaller the bending radius is, the shorter the sensing distance will be.
- Insert the tip of the stainless steel tube in the Sleeve Bender and slowly bend the tube along the curve of the Sleeve Bender.

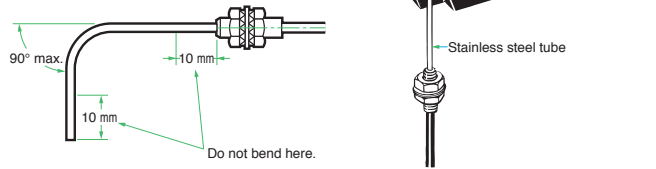

Heat-resistant Fiber Units (E32-D51(R) and E32-T51(R))

The fibers of these Units cannot be extended using the E39-F10 Fiber Connector.

E32-T14

These Units may enter the light-ON state if there are reflective objects at the end of the lenses.

If reflection is a problem, attach the black stickers provided to the ends of the lenses.

E32-T16PR

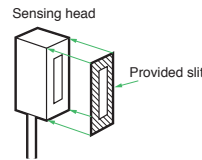

To use the provided slit, peel off the backing sheet, align the slit with the edges of the sensing surface, and attach it to the sensing head.

Use the slit in applications where saturation occurs (i.e., changes in incident level cannot be detected) due to short sensing distances.

Vacuum-resistant Fiber Units (E32-□V)

Although the Flanges, the Fiber Units on the vacuum side, and the Lens Units have been cleaned, as an extra precaution, clean these with alcohol before using them in high-vacuum environments to ensure that they are properly degreased.

Liquid-level Detection Fiber Unit (E32-D82F1)

- Secure the Fiber Unit using the unbendable section. Otherwise, the liquid-level detection position may be displaced.
- For applications in hazardous environments, install the Fiber Unit in the hazardous environment but install the Amplifier Unit in a safe environment.

Liquid-level Detection Fiber Units (Tube-mounting Models)

- Make sure that the tube is not deformed when using a band to secure the Fiber Unit.

● **Adjustment**

Detection Position for Liquid-level Detection Fiber Unit (E32-D82F1)

The liquid-level detection position is 5.2 ±2 mm from the end of the fluoro-resin section. (Refer to the diagram on the right.)

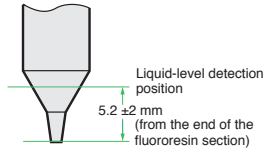

The liquid-level detection position varies with the surface tension of the liquid and the degree of wetness at the Fiber Unit's detection position.

● **Other Precautions**

Liquid-level Detection Fiber Unit (E32-D82F1)

- Operation may become unstable in the following cases:
 1. Bubbles stick to the cone of the sensing head.
 2. Solute deposits on the cone of the sensing head.
 3. The liquid has a high viscosity.
- There are some liquids, such as milky white liquids, for which detection is not possible.
- Do not let the end of the fluoro-resin section bump into other objects.
Damage to or deformation of the sensing head may cause unstable operation.

Chemical and Oil-resistant, Liquid-level Detection Fiber Unit (E32-D82F1)

Fluoro-resin shows strong chemical-resistant properties but is permeable if exposed to atmospheres with gaseous chemicals or water vapors, resulting in failure or damage. Confirm applicability sufficiently before using the Fiber Unit in these environments.

Accessories

Use of E39-R3 Reflector Provided with E32-R21

1. Use detergent to remove any dust or oil from the surfaces where tape is applied. Adhesive tape will not be attached properly if oil or dust remains on the surface.
2. The E39-R3 cannot be used in areas that are exposed to oil or chemicals.

Mounting method of Protective Spiral Tubes

1. Insert the Fiber Unit into the Protective Spiral Tube from the head connector (threaded).
2. Push the fiber into the Protective Spiral Tube. The tube must be straight so that the fiber enters without twisting. Turn the Protective Spiral Tube, not the fiber.
3. Secure the Protective Spiral Tube to the mounting panel with the provided nuts.

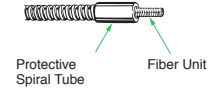
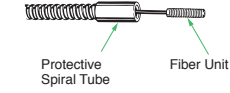

4. Use the provided saddle to secure the end cap of the Protective Spiral Tube.
(To secure the Protective Spiral Tube at a position other than the end cap, apply tape to the tube so that the portion becomes thicker in diameter.)

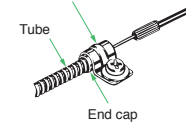
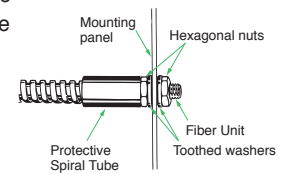

Attaching the E39-F10 Fiber Connector

Attach the Fiber Connector as shown in the following figures.

1. Insert the Fiber Unit in the retention splice.
2. Insert the retention clip into the splice.

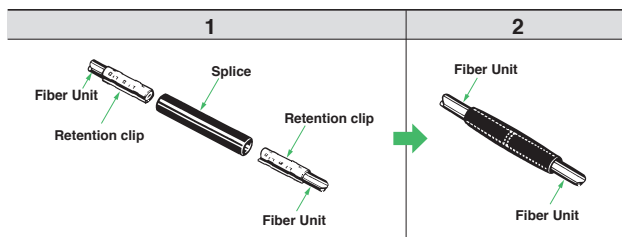

- The Fiber Units should be as close as possible when they are connected.
The sensing distance is reduced by approximately 25% when Fiber Units are extended by the connector.
- Only 2.2-mm-diameter fibers can be connected.

Fiber Sensor Features

Selection Guide

Fiber Units

Threaded	Standard Installation
Cylindrical	
Flat	Saving Space
Sleeved	
Small Spot	Beam Improvements
High Power	
Narrow view	
BGS	Transparent Objects
Retro-reflective	
Limited-reflective	
Chemical-resistant, Oil-resistant	Environmental Immunity
Bending	
Heat-resistant	
Area Detection	Applications
Liquid-level	
Vacuum	
FPD, Semi, Solar	Installation Information

Fiber Amplifiers, Communications Unit, and Accessories

Technical Guide and Precautions

Model Index

Hex-shaped Models

Fiber Sensor Features

Selection Guide

Fiber Units

Standard Installation

Saving Space

Beam Improvements

Transparent Objects

Environmental Immunity

Applications

Installation Information

Fiber Amplifiers, Communications Unit, and Accessories

Technical Guide and Precautions

Model Index

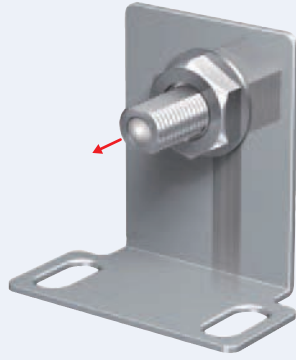

- You can easily mount these Fiber Units by making a hole in the bracket and tightening just one nut.
- The cable follows the wall, so extra space is not required, and the cable will not get caught on other objects.



Build-in Lens
 A Fiber Unit with Build-in Lens is the new standard in fiber units. A high-power beam ensures stable detection even in dusty environments, and an aperture angle of 15° reduces false operation for reflection off of surrounding objects in narrow locations. Since it has a built-in lens, you don't have to worry about the lens falling off and getting lost.



Specifications

Through-beam Fiber Units

Aperture angle	Size	Appearance (mm)	Bending radius of cable	Sensing distance (mm)						Optical axis diameter (minimum sensing object)	Models	97 Page Dimensions No.
				E3X-HD			E3NX-FA NEW					
				GIGA	HS	Other modes	GIGA	HS	Other modes			
Approx. 15°	M4		Flexible, R2	4,000*	ST : 3,500	4,000*	4,000*	ST : 4,000*	2.3 dia. (0.1 dia./ 0.03 dia.)	E32-LT11N 2M NEW	97-A	
				2,300	SHS: 920	3,450	SHS: 920					
Approx. 60°	M4		Flexible, R1	2,000	ST : 1,000	3,000	ST : 1,500	1 dia. (5 μm dia./ 2 μm dia.)	E32-T11N 2M	97-B		

Reflective Fiber Units

Aperture angle	Size	Appearance (mm)	Bending radius of cable	Sensing distance (mm)						Optical axis diameter (minimum sensing object)	Models	97 Page Dimensions No.
				E3X-HD			E3NX-FA NEW					
				GIGA	HS	Other modes	GIGA	HS	Other modes			
Approx. 15°	M6		Flexible, R2	840	ST : 350	1,260	ST : 520	(0.1 dia./ 0.03 dia.)	E32-LD11N 2M NEW	97-C		
				240	SHS: 100	360	SHS: 100					
Approx. 60°	M3		Flexible, R2	290	ST : 130	440	ST : 190	(5 μm dia./ 2 μm dia.)	E32-C21N 2M NEW	97-D		
	M4			90	SHS: 39	130	SHS: 39					
	M4		Flexible, R4	840	ST : 350	1,260	ST : 520	(5 μm dia./ 2 μm dia.)	E32-D21N 2M NEW	97-E		
	M6			240	SHS: 100	360	SHS: 100					
	M6			780	ST : 350	1,170	ST : 520	(5 μm dia./ 2 μm dia.)	E32-C11N 2M	97-F		

Retro-reflective Fiber Units (With M.S.R. Function)

Aperture angle	Size	Appearance (mm)	Bending radius of cable	Sensing distance (mm)						Optical axis diameter (minimum sensing object)	Models	97 Page Dimensions No.
				E3X-HD			E3NX-FA NEW					
				GIGA	HS	Other modes	GIGA	HS	Other modes			
Approx. 15°	M6		Flexible, R2	1,350	ST : 1,200	2,020	ST : 1,800	—	E32-LR11NP 2M + E39-RP1 NEW	97-G		

* The optical fiber is 2 m long on each side, so the sensing distance is 4,000 mm.
Note 1. The following mode names and response times apply to the modes given in the Sensing distance column.
 [E3X-HD] GIGA: Giga-power mode (16 ms), HS: High-speed mode (250 μs), ST: Standard mode (1 ms), and SHS: Super-high-speed mode (NPN output: 50 μs, PNP output: 55 μs)
 [E3NX-FA] GIGA: Giga-power mode (16 ms), HS: High-speed mode (250 μs), ST: Standard mode (1 ms), and SHS: Super-high-speed mode (30 μs)
 2. The values for the minimum sensing object are reference values that indicate values obtained in standard mode with the sensing distance and sensitivity set to the optimum values. The first value is for the E3X-HD and the second value is for the E3NX-FA.
 3. The sensing distances for Reflective Sensors are for white paper. (The sensing distances for the E32-LD11N 2M are for glossy white paper).
 4. With Retro-reflective Models, objects with a high reflection factor may cause the Fiber Sensor to detect reflected light as incident light. Also, stable detection may not be possible for transparent objects. Check suitability beforehand.

Dimensions

Installation Information → 58, 59, 60, 61 Page

Through-beam Fiber Units

97-A E32-LT11N 2M (Free Cutting)

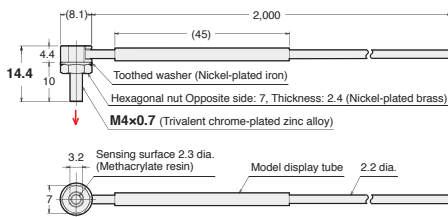

97-B E32-T11N 2M (Free Cutting)

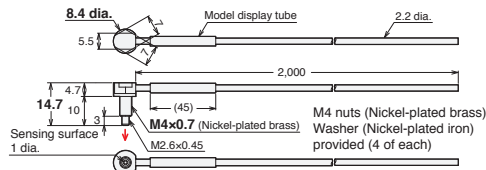

Reflective Fiber Units

97-C E32-LD11N 2M (Free Cutting)

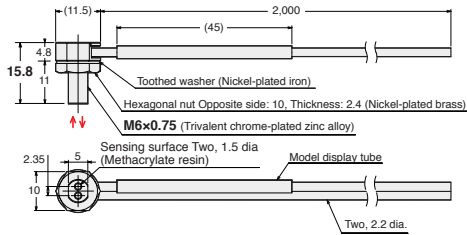

97-D E32-C21N 2M (Free Cutting)

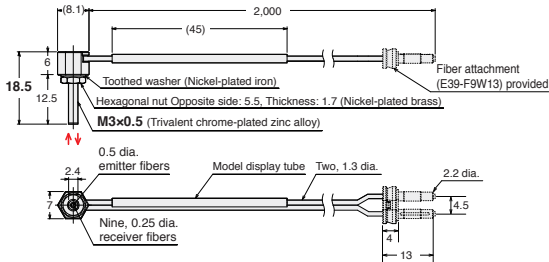

Note: There is a white line on the emitter fiber.

97-E E32-D21N 2M (Free Cutting)

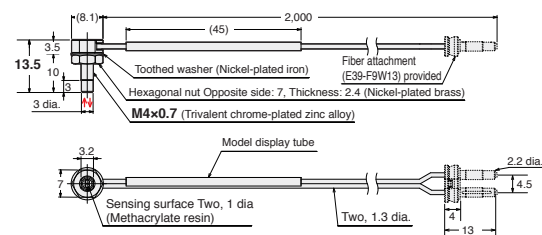

97-F E32-C11N 2M (Free Cutting)

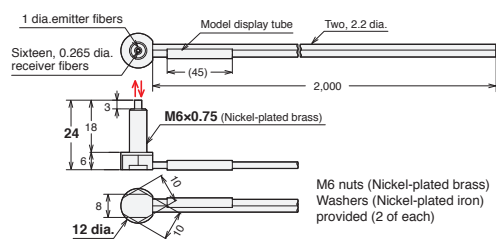

Note: There is a white line on the emitter fiber.

Retro-reflective Fiber Units (With M.S.R. Function)

97-G E32-LR11NP 2M (Free Cutting)

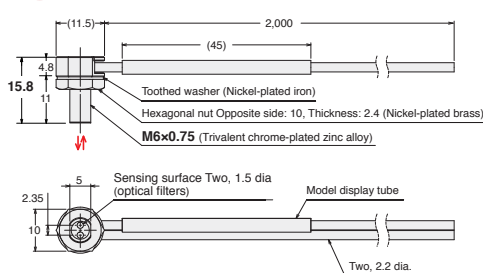

E39-RP1

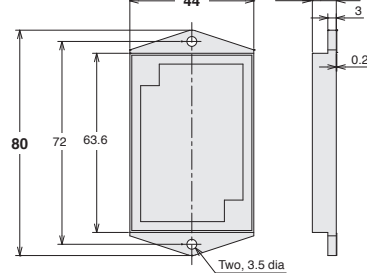

Material:
<Reflective surface>
Methacrylate resin
<Back> ABS

- Reference Information for Model Selection -

Features of Coaxial Reflective Type

These Fiber Units offer better detection of small objects at close distances (of 2 mm or less) than Standard Reflective Fiber Units.

They also detect glossy surfaces more reliably than Standard Reflective Fiber Units, even if the surface is tilted.

The receiver fibers are arranged around the emitter fiber as shown below.

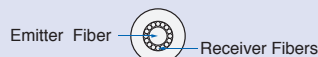

What Is "Flexible" Fiber?

The flexible fiber has a small bending radius for easy routing without easily breaking.

It is easy to use because the cable can be bent without significantly reducing light intensity.

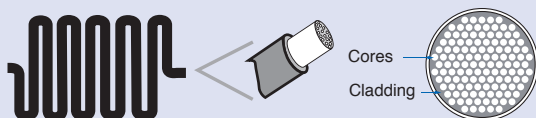

Structure which has a cladding around a large number of ultrafine cores.

Transparent Object Detection

Retro-reflective Models are ideal for detection of transparent objects.

→ 35 Page: Performance Comparison of Transparent Object Detection

And

Long-distance Sensing Applications with the E32-T11N

A separate Lens Unit can be attached to extend the sensing distance.

→ 26 Page

Fiber Sensor Features

Selection Guide

Fiber Units

Threaded

Cylindrical

Flat

Sleeved

Small Spot

High Power

Narrow view

BGS

Retro-reflective

Limited-reflective

Chemical-resistant, Oil-resistant

Bending

Heat-resistant

Area Detection

Liquid-level

Vacuum

FPD, Semi, Solar

Installation Information

Fiber Amplifiers, Communications Unit, and Accessories

Technical Guide and Precautions

Model Index

Fiber Sensor Features

Selection Guide

Fiber Units

Standard Installation

Saving Space

Beam Improvements

Transparent Objects

Environmental Immunity

Applications

Installation Information

Fiber Amplifiers, Communications Unit, and Accessories

Technical Guide and Precautions

Model Index

Models	Specifications	Dimensions
E32-A		
E32-A01 5M	P.50	P.51 (51-A)
E32-A03 2M	P.30	P.31 (31-A)
	P.56	P.57 (57-A)
E32-A03-1 2M	P.30	P.31 (31-B)
	P.56	P.57 (57-B)
E32-A04 2M	P.30	P.31 (31-C)
	P.56	P.57 (57-C)
E32-A08 2M	P.36	P.37 (37-C)
	P.54	P.55 (55-B)
E32-A08H2 2M	P.46	P.47 (47-D)
	P.54	P.55 (55-C)
E32-A09 2M	P.36	P.37 (37-F)
	P.54	P.55 (55-E)
E32-A09H2 2M	P.46	P.47 (47-E)
	P.54	P.55 (55-F)
E32-A12 2M	P.36	P.37 (37-D)
	P.54	P.55 (55-D)
E32-C		
E32-C11N 2M	P.08 (P.22)	P.09 (P.23) (09-B)
E32-C21N 2M	P.96 (P.20, 22)	P.97 (P.21, 23) (97-D)
E32-C31 2M	P.08 (P.20, 22)	P.09 (P.21, 23) (09-D)
E32-C31M 1M	P.08	P.09 (09-E)
E32-C31N 2M	P.08	P.09 (09-A)
E32-C41 1M	P.22	P.23 (23-A) (23-D)
E32-C42 1M	P.20	P.21 (21-A) (21-B)
E32-C42S 1M	P.20	P.21 (21-E)
E32-CC200 2M	P.08 (P.22)	P.09 (P.23) (09-H)
E32-D		
E32-D11 2M	P.42	P.43 (43-E)
E32-D11R 2M	P.08	P.09 (09-G)
E32-D11U 2M	P.38	P.39 (39-I)
E32-D12F 2M	P.38	P.39 (39-H)
E32-D15XR 2M	P.14	P.15 (15-D)
E32-D15YR 2M	P.14	P.15 (15-E)
E32-D15ZR 2M	P.14	P.15 (15-F)
E32-D16 2M	P.24	P.25 (25-E)
E32-D21 2M	P.42	P.43 (43-B)
E32-D211R 2M	P.08	P.09 (09-F)
E32-D21B 2M	P.42	P.43 (43-D)
E32-D21N 2M	P.96	P.97 (97-E)
E32-D21R 2M	P.08	P.09 (09-C)
E32-D21-S3 2M	P.18	P.19 (19-J)
E32-D221B 2M	P.12	P.13 (13-D)
	P.42	P.43 (43-C)
E32-D22B 2M	P.12	P.13 (13-A)
	P.42	P.43 (43-A)
E32-D22R 2M	P.12	P.13 (13-C)
E32-D22-S1 2M	P.18	P.19 (19-I)
E32-D24R 2M	P.18	P.19 (19-A)
E32-D24-S2 2M	P.18	P.19 (19-B)
E32-D25XB 2M	P.42	P.43 (43-F)
E32-D25-S3 2M	P.18	P.19 (19-L)
E32-D31-S1 0.5M	P.18	P.19 (19-G)
E32-D32L 2M	P.12	P.13 (13-E)
E32-D32-S1 0.5M	P.18	P.19 (19-F)
E32-D33 2M	P.12	P.13 (13-F)
	P.18	P.19 (19-E)

Models	Specifications	Dimensions
E32-D331 2M	P.18	P.19 (19-D)
E32-D36P1 2M	P.48	P.49 (49-D)
E32-D36T 2M	P.50	P.51 (51-C)
E32-D43M 1M	P.12	P.13 (19-B)
	P.18	P.19 (19-C)
E32-D51 2M	P.46	P.47 (47-B)
E32-D51R 2M	P.46	P.47 (47-A)
E32-D61-S 2M	P.46	P.47 (47-G)
E32-D611-S 2M	P.46	P.47 (47-F)
E32-D73-S 2M	P.46	P.47 (47-H)
E32-D81R-S 2M	P.46	P.47 (47-C)
E32-D82F1 4M	P.50	P.51 (51-D)
E32-DC200BR 2M	P.18	P.19 (19-K)
E32-DC200F4R 2M	P.18	P.19 (19-H)
E32-L		
E32-L11FP 2M	P.38	P.39 (39-F)
	P.54	P.55 (55-G)
E32-L11FS 2M	P.38	P.39 (39-G)
	P.54	P.55 (55-H)
E32-L15 2M	P.20	P.21 (21-F)
E32-L16-N 2M	P.32	P.33 (39-A)
	P.36	P.37 (37-B)
	P.54	P.55 (55-A)
E32-L24S 2M	P.32	P.33 (33-B)
	P.36	P.37 (37-A)
E32-L25L 2M	P.32	P.33 (33-C)
	P.36	P.37 (37-E)
E32-L25T 2M	P.50	P.51 (51-B)
E32-LD11 2M	P.08	P.09 (09-I)
E32-LD11N 2M	P.96	P.97 (97-C)
E32-LD11R 2M	P.08	P.09 (09-I)
E32-LR11NP 2M	P.34	P.35 (35-A)
	P.96	P.97 (97-G)
E32-LT11 2M	P.06	P.07 (07-C)
	P.24	P.25 (25-C)
E32-LT11N 2M	P.24	P.25 (25-A)
	P.96	P.97 (97-A)
E32-LT11R 2M	P.06	P.07 (07-C)
	P.24	P.25 (25-C)
E32-R		
E32-R16 2M	P.34	P.35 (35-B)
E32-R21 2M	P.34	P.35 (35-C)
E32-T		
E32-T10V 2M	P.52	P.53 (53-D)
E32-T11 2M	P.40 (P.26)	P.41 (P.27) (41-C)
E32-T11F 2M	P.38	P.39 (39-C)
E32-T11N 2M	P.06 (P.26)	P.07 (P.27) (07-A)
E32-T11NF 2M	P.38	P.39 (39-A)
E32-T11R 2M	P.06 (P.24)	P.07 (P.25, 26) (07-B)
E32-T12F 2M	P.38	P.39 (39-B)
E32-T12R 2M	P.10	P.11 (11-C)
E32-T14 2M	P.24	P.25 (25-D)
E32-T14F 2M	P.38	P.39 (39-D)
E32-T14LR 2M	P.10	P.11 (11-D)
E32-T15XR 2M	P.14	P.15 (15-A)
E32-T15YR 2M	P.14	P.15 (15-B)
E32-T15ZR 2M	P.14	P.15 (15-C)
E32-T16JR 2M	P.48	P.49 (49-B)
E32-T16PR 2M	P.48	P.49 (49-A)
E32-T16WR 2M	P.48	P.49 (49-C)
E32-T17L 10M	P.24	P.25 (25-B)

Models	Specifications	Dimensions
E32-T21 2M	P.40	P.41 (41-B)
E32-T21-S1 2M	P.16	P.17 (17-D)
E32-T223R 2M	P.10	P.11 (11-A)
E32-T22B 2M	P.10	P.11 (11-B)
	P.40	P.41 (41-A)
E32-T22S 2M	P.30	P.31 (31-F)
E32-T24E 2M	P.16	P.17 (17-B)
E32-T24R 2M	P.16	P.17 (17-A)
E32-T24S 2M	P.30	P.31 (31-E)
	P.56	P.57 (57-E)
E32-T24SR 2M	P.30	P.31 (31-D)
	P.56	P.57 (57-D)
E32-T25XB 2M	P.40	P.41 (41-D)
E32-T33 1M	P.16	P.17 (17-C)
E32-T51 2M	P.44 (P.28)	P.45 (P.29) (45-B)
E32-T51F 2M	P.38	P.39 (39-E)
E32-T51R 2M	P.44 (P.28)	P.45 (P.29) (45-A)
E32-T51V 1M	P.52	P.53 (53-A)
E32-T61-S 2M	P.44 (P.28)	P.45 (P.29) (45-D)
E32-T81R-S 2M	P.44 (P.28)	P.45 (P.29) (45-C)
E32-T84SV 1M	P.52	P.53 (53-C)
E32-TC200BR 2M	P.16	P.17 (17-E)
E32-V		
E32-VF1	P.52	P.53 (53-F)
E32-VF4	P.52	P.53 (53-E)
E39-F		
E39-F1	P.26, 28	P.26 (26-A)
E39-F1-33	P.28	P.28 (26-D)
E39-F11	P.17	—
E39-F16	P.26, 28	P.26 (26-B)
E39-F17	P.20	P.21 (21-B)
E39-F18	P.22	P.23 (23-G) (23-H)
E39-F1V	P.52	P.53 (53-B)
E39-F2	P.26, 28	P.26 (26-C)
E39-F32A 1M	P.42	P.43 (43-G)
E39-F32C 1M	P.40	P.41 (41-E)
	P.42	P.43 (43-G)
E39-F32D 1M	P.42	P.43 (43-G)
E39-F3A	P.20	P.21 (21-A)
E39-F3A-5	P.22	P.23 (23-A) (23-B) (23-C)
E39-F3B	P.22	P.23 (23-D) (23-E) (23-F)
E39-F3C	P.20	P.21 (21-C) (21-D)
E39-R		
E39-R1	—	P.35 (35-B)
E39-R3	—	P.35 (35-C)
E39-RP1	P.34	P.35 (35-A) (P.96) (P.97) (97-G)
E39-RP37	P.35	—
E39-RSP1	P.35	—
E39-L		
E39-L143	—	P.89 (89-A)
E3NW		
E3NW-DS	P.76	P.77 (77-B)
E3NW-ECT	P.76	P.77 (77-A)

Models	Specifications	Dimensions
E3NX-FA		
E3NX-FA0	P.66	P.69 (69-B)
E3NX-FA11 2M	P.66	P.68 (68-A)
E3NX-FA21 2M	P.66	P.68 (68-A)
E3NX-FA24	P.66	P.69 (69-A)
E3NX-FA41 2M	P.66	P.68 (68-A)
E3NX-FA51 2M	P.66	P.68 (68-A)
E3NX-FA54	P.66	P.69 (69-A)
E3NX-FA54TW	P.66	P.69 (69-A)
E3NX-FA6	P.66	P.68 (68-B)
E3NX-FA7	P.66	P.68 (68-B)
E3NX-FA7TW	P.66	P.68 (68-B)
E3NX-FA8	P.66	P.68 (68-B)
E3NX-FA9	P.66	P.68 (68-B)
E3NX-FA9TW	P.66	P.68 (68-B)
E3X-CN		
E3X-CN11	P.88	P.88 (88-A)
E3X-CN12	P.88	P.88 (88-B)
E3X-CN21	P.88	P.88 (88-A)
E3X-CN22	P.88	P.88 (88-B)
E3X-CRT		
E3X-CRT	P.86	P.87 (87-A)
E3X-ECT		
E3X-ECT	P.86	P.87 (87-B)
E3X-HD		
E3X-HD0	P.80	P.81 (81-C)
E3X-HD11 2M	P.80	P.80 (80-A)
E3X-HD14	P.80	P.81 (81-B)
E3X-HD41 2M	P.80	P.80 (80-A)
E3X-HD44	P.80	P.81 (81-B)
E3X-HD6	P.80	P.81 (81-A)
E3X-HD8	P.80	P.81 (81-A)
PFP		
PFP-100N	—	P.89 (89-B)
PFP-100N2	—	P.89 (89-C)
PFP-50N	—	P.89 (89-B)
PFP-M	—	P.89 (89-D)
XS3F		
XS3F-M421-402-A	P.88	P.88 (88-C)
XS3F-M421-405-A	P.88	P.88 (88-C)
XS3F-M422-402-A	P.88	P.88 (88-D)
XS3F-M422-405-A	P.88	P.88 (88-D)

Terms and Conditions Agreement

Read and understand this catalog.

Please read and understand this catalog before purchasing the products. Please consult your OMRON representative if you have any questions or comments.

Warranties.

- (a) Exclusive Warranty. Omron's exclusive warranty is that the Products will be free from defects in materials and workmanship for a period of twelve months from the date of sale by Omron (or such other period expressed in writing by Omron). Omron disclaims all other warranties, express or implied.
- (b) Limitations. OMRON MAKES NO WARRANTY OR REPRESENTATION, EXPRESS OR IMPLIED, ABOUT NON-INFRINGEMENT, MERCHANTABILITY OR FITNESS FOR A PARTICULAR PURPOSE OF THE PRODUCTS. BUYER ACKNOWLEDGES THAT IT ALONE HAS DETERMINED THAT THE PRODUCTS WILL SUITABLY MEET THE REQUIREMENTS OF THEIR INTENDED USE.

Omron further disclaims all warranties and responsibility of any type for claims or expenses based on infringement by the Products or otherwise of any intellectual property right. (c) Buyer Remedy. Omron's sole obligation hereunder shall be, at Omron's election, to (i) replace (in the form originally shipped with Buyer responsible for labor charges for removal or replacement thereof) the non-complying Product, (ii) repair the non-complying Product, or (iii) repay or credit Buyer an amount equal to the purchase price of the non-complying Product; provided that in no event shall Omron be responsible for warranty, repair, indemnity or any other claims or expenses regarding the Products unless Omron's analysis confirms that the Products were properly handled, stored, installed and maintained and not subject to contamination, abuse, misuse or inappropriate modification. Return of any Products by Buyer must be approved in writing by Omron before shipment. Omron Companies shall not be liable for the suitability or unsuitability or the results from the use of Products in combination with any electrical or electronic components, circuits, system assemblies or any other materials or substances or environments. Any advice, recommendations or information given orally or in writing, are not to be construed as an amendment or addition to the above warranty.

See <http://www.omron.com/global/> or contact your Omron representative for published information.

Limitation on Liability; Etc.

OMRON COMPANIES SHALL NOT BE LIABLE FOR SPECIAL, INDIRECT, INCIDENTAL, OR CONSEQUENTIAL DAMAGES, LOSS OF PROFITS OR PRODUCTION OR COMMERCIAL LOSS IN ANY WAY CONNECTED WITH THE PRODUCTS, WHETHER SUCH CLAIM IS BASED IN CONTRACT, WARRANTY, NEGLIGENCE OR STRICT LIABILITY.

Further, in no event shall liability of Omron Companies exceed the individual price of the Product on which liability is asserted.

Suitability of Use.

Omron Companies shall not be responsible for conformity with any standards, codes or regulations which apply to the combination of the Product in the Buyer's application or use of the Product. At Buyer's request, Omron will provide applicable third party certification documents identifying ratings and limitations of use which apply to the Product. This information by itself is not sufficient for a complete determination of the suitability of the Product in combination with the end product, machine, system, or other application or use. Buyer shall be solely responsible for determining appropriateness of the particular Product with respect to Buyer's application, product or system. Buyer shall take application responsibility in all cases.

NEVER USE THE PRODUCT FOR AN APPLICATION INVOLVING SERIOUS RISK TO LIFE OR PROPERTY OR IN LARGE QUANTITIES WITHOUT ENSURING THAT THE SYSTEM AS A WHOLE HAS BEEN DESIGNED TO ADDRESS THE RISKS, AND THAT THE OMRON PRODUCT(S) IS PROPERLY RATED AND INSTALLED FOR THE INTENDED USE WITHIN THE OVERALL EQUIPMENT OR SYSTEM.

Programmable Products.

Omron Companies shall not be responsible for the user's programming of a programmable Product, or any consequence thereof.

Performance Data.

Data presented in Omron Company websites, catalogs and other materials is provided as a guide for the user in determining suitability and does not constitute a warranty. It may represent the result of Omron's test conditions, and the user must correlate it to actual application requirements. Actual performance is subject to the Omron's Warranty and Limitations of Liability.

Change in Specifications.

Product specifications and accessories may be changed at any time based on improvements and other reasons. It is our practice to change part numbers when published ratings or features are changed, or when significant construction changes are made. However, some specifications of the Product may be changed without any notice. When in doubt, special part numbers may be assigned to fix or establish key specifications for your application. Please consult with your Omron's representative at any time to confirm actual specifications of purchased Product.

Errors and Omissions.

Information presented by Omron Companies has been checked and is believed to be accurate; however, no responsibility is assumed for clerical, typographical or proofreading errors or omissions.

The N-Smart Lineup

E3NX-FA
Fiber Amplifier Units

N-Smart Amplifier Units
Easy application with consistent operating procedures.

E3NC-S
Ultra-compact CMOS
Laser Sensors
Cat. No. E427

E3NC-L
Compact
Laser Sensors
Cat. No. E427

E9NC-T
Contact-Type Smart Sensor
Cat. No. E433

E3NW
Sensor
Communications Units
Cat. No. E428

Applications with Many Sensors:
More convenience and even lower costs
with a network.

N-Smart
Presence / Detection / Measurement

EtherCAT

CompoNet

CC-Link V2

NEW Introducing New Fiber Sensor Products

Fiber Units with Build-in Lenses Build-in Lens

Hex-shaped models
E32-LT11N/LD11N/LR11NP
→ **96 Page**

Straight type
E32-LT11(R)/LD11(R)
→ **06, 08 Page**

Fiber Amplifier Units
E3NX-FA
→ **62 Page**

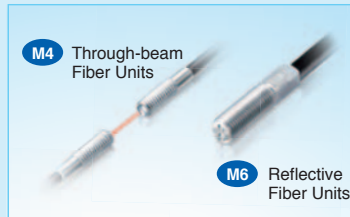

EtherCAT® is a registered trademark and patented technology, licensed by Beckhoff Automation GmbH, Germany.
CompoNet is a registered trademark of the ODVA.
CC-Link is a registered trademark of Mitsubishi Electric Corporation. The trademark is managed by the CC-Link Partner Association.

OMRON Corporation Industrial Automation Company
Tokyo, JAPAN

Contact: www.ia.omron.com

Regional Headquarters

OMRON EUROPE B.V.
Sensor Business Unit
Carl-Benz-Str. 4, D-71154 Nufringen, Germany
Tel: (49) 7032-811-0/Fax: (49) 7032-811-199

OMRON ELECTRONICS LLC
2895 Greenspoint Parkway, Suite 200
Hoffman Estates, IL 60169 U.S.A
Tel: (1) 847-843-7900/Fax: (1) 847-843-7787

OMRON ASIA PACIFIC PTE. LTD.
No. 438A Alexandra Road # 05-05/08 (Lobby 2),
Alexandra Technopark,
Singapore 119967
Tel: (65) 6835-3011/Fax: (65) 6835-2711

OMRON (CHINA) CO., LTD.
Room 2211, Bank of China Tower,
200 Yin Cheng Zhong Road,
PuDong New Area, Shanghai, 200120, China
Tel: (86) 21-5037-2222/Fax: (86) 21-5037-2200

Authorized Distributor:

© OMRON Corporation 2012-2014 All Rights Reserved.
In the interest of product improvement,
specifications are subject to change without notice.
CSM_9_2_0715
Cat. No. E418-E1-04

Printed in Japan
0814 (0212)



Стандарт Электрон Связь

Мы молодая и активно развивающаяся компания в области поставок электронных компонентов. Мы поставляем электронные компоненты отечественного и импортного производства напрямую от производителей и с крупнейших складов мира.

Благодаря сотрудничеству с мировыми поставщиками мы осуществляем комплексные и плановые поставки широчайшего спектра электронных компонентов.

Собственная эффективная логистика и склад в обеспечивает надежную поставку продукции в точно указанные сроки по всей России.

Мы осуществляем техническую поддержку нашим клиентам и предпродажную проверку качества продукции. На все поставляемые продукты мы предоставляем гарантию .

Осуществляем поставки продукции под контролем ВП МО РФ на предприятия военно-промышленного комплекса России , а также работаем в рамках 275 ФЗ с открытием отдельных счетов в уполномоченном банке. Система менеджмента качества компании соответствует требованиям ГОСТ ISO 9001.

Минимальные сроки поставки, гибкие цены, неограниченный ассортимент и индивидуальный подход к клиентам являются основой для выстраивания долгосрочного и эффективного сотрудничества с предприятиями радиоэлектронной промышленности, предприятиями ВПК и научно-исследовательскими институтами России.

С нами вы становитесь еще успешнее!

Наши контакты:

Телефон: +7 812 627 14 35

Электронная почта: sales@st-electron.ru

Адрес: 198099, Санкт-Петербург,
Промышленная ул, дом № 19, литера Н,
помещение 100-Н Офис 331