

CMOS Quad 'D'-Type Flip-Flop

High-Voltage Types (20-Volt Rating)

Features:

- 100% tested for quiescent current at 20 V
- Maximum input current of 1 μ A at 18 V over full package-temperature range; 100 nA at 18 V and 25°C
- Noise margin (full package-temperature range) =
 - 1 V at $V_{DD} = 5$ V
 - 2 V at $V_{DD} = 10$ V
 - 2.5 V at $V_{DD} = 15$ V
- 5-V, 10-V, and 15-V parametric ratings

- Meets all requirements of JEDEC Tentative Standard No. 13B, "Standard Specifications for Description of 'B' Series CMOS Devices"
- Output compatible with two HTL loads, two low power TTL loads, or one low power Schottky TTL load
- Functional equivalent to TTL 74175
- Standardized symmetrical output characteristics

Applications:

- Shift registers
- Buffer/storage registers
- Pattern generators

■ CD40175B consists of four identical D-type flip-flops. Each flip-flop has an independent DATA D input and complementary Q and \bar{Q} outputs. The CLOCK and CLEAR inputs are common to all flip-flops. Data are transferred to the Q outputs on the positive-going transition of the clock pulse. All four flip-flops are simultaneously reset by a low level on the CLEAR input.

These devices can function as shift register elements or as T-type flip-flops for toggle and counter applications.

The CD40175B types are supplied in 16-lead hermetic dual-in-line ceramic packages (F3A suffix), 16-lead dual-in-line plastic packages (E suffix), 16-lead small-outline packages (M, M96, MT, and NSR suffixes), and 16-lead thin shrink small-outline packages (PW and PWR suffixes).

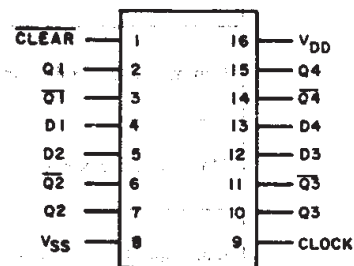
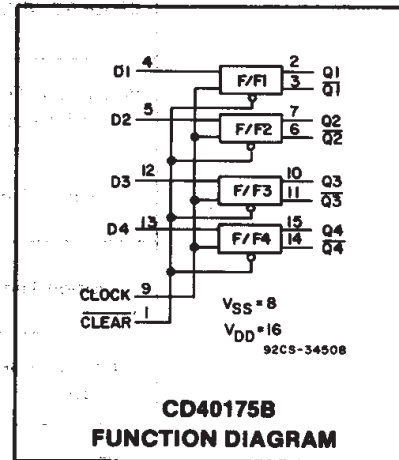

$V_{DD} = \text{PIN } 16$
 $V_{SS} = \text{PIN } 8$ 92CS-34507

TERMINAL ASSIGNMENT

MAXIMUM RATINGS, Absolute-Maximum Values:

DC SUPPLY-VOLTAGE RANGE, (V_{DD})	-0.5V to +20V
Voltages referenced to V_{SS} Terminal)	
INPUT VOLTAGE RANGE, ALL INPUTS	-0.5V to $V_{DD} + 0.5V$
DC INPUT CURRENT, ANY ONE INPUT	± 10 mA
POWER DISSIPATION PER PACKAGE (P_D):		
For $T_A = -55^\circ\text{C}$ to $+100^\circ\text{C}$	500mW
For $T_A = +100^\circ\text{C}$ to $+125^\circ\text{C}$	Derate Linearly at 12mW/°C to 200mW
DEVICE DISSIPATION PER OUTPUT TRANSISTOR		
FOR $T_A = \text{FULL PACKAGE-TEMPERATURE RANGE (All Package-Types)}$	100mW
OPERATING-TEMPERATURE RANGE (T_A)	-55°C to $+125^\circ\text{C}$
STORAGE TEMPERATURE RANGE (T_{stg})	-65°C to $+150^\circ\text{C}$
LEAD TEMPERATURE (DURING SOLDERING):		
At distance $1/16 \pm 1/32$ inch (1.59 ± 0.79 mm) from case for 10s max	$+265^\circ\text{C}$

CD40175B Types

RECOMMENDED OPERATING CONDITIONS at $T_A = 25^\circ\text{C}$, Except as Noted.

For maximum reliability, nominal operating conditions should be selected so that operation is always within the following ranges:

CHARACTERISTIC	V _{DD} (V)	LIMITS		UNITS
		MIN.	MAX.	
Supply-Voltage Range (For $T_A =$ Full Package-Temperature Range)	—	3	18	V
Data Setup Time	5	120	—	ns
	10	50	—	
	15	40	—	
Data Hold Time	5	80	—	ns
	10	40	—	
	15	30	—	
Clock Input Frequency	5	—	2	MHz
	10	dc	5	
	15	—	6.5	
Clock Input Rise or Fall Time	5	—	15	μs
	10	—	15	
	15	—	15	
Clock Input Pulse Width	5	250	—	ns
	10	100	—	
	15	75	—	
Clear Pulse Width	5	200	—	ns
	10	80	—	
	15	60	—	
Clear Removal Time	5	250	—	ns
	10	100	—	
	15	80	—	

3
COMMERCIAL CMOS
HIGH VOLTAGE ICs



Fig. 1 - Logic diagram (1 of 4 flip-flops).

CD40175B Types

STATIC ELECTRICAL CHARACTERISTICS

CHARACTERISTIC	CONDITIONS			LIMITS AT INDICATED TEMPERATURES (°C)							UNITS
	V _O (V)	V _{IN} (V)	V _{DD} (V)	-55	-40	+85	+125	+25			
								Min.	Typ.	Max.	
Quiescent Device Current Max. I _{DD}	—	0, 5	5	1	1	30	30	—	0.02	1	μA
	—	0, 10	10	2	2	60	60	—	0.02	2	
	—	0, 15	15	4	4	120	120	—	0.02	4	
	—	0, 20	20	20	20	600	600	—	0.04	20	
Output Low (Sink) Current Min. I _{OL}	0.4	0, 5	5	0.64	0.61	0.42	0.36	0.51	1	—	mA
	0.5	0, 10	10	1.6	1.5	1.1	0.9	1.3	2.6	—	
	1.5	0, 15	15	4.2	4	2.8	2.4	3.4	6.8	—	
Output High (Source) Current Min. I _{OH}	4.6	0, 5	5	-0.64	-0.61	-0.42	-0.36	-0.51	-1	—	mA
	2.5	0, 5	5	-2	-1.8	-1.3	-1.15	-1.6	-3.2	—	
	9.5	0, 10	10	-1.6	-1.5	-1.1	-0.9	-1.3	-2.6	—	
	13.5	0, 15	15	-4.2	-4	-2.8	-2.4	-3.4	-6.8	—	
Output Voltage: Low-Level Max. V _{OL}	—	0, 5	5	0.05				—	0	0.05	V
	—	0, 10	10	0.05				—	0	0.05	
	—	0, 15	15	0.05				—	0	0.05	
Output Voltage: High-Level Min. V _{OH}	—	0, 5	5	4.95				4.95	5	—	V
	—	0, 10	10	9.95				9.95	10	—	
	—	0, 15	15	14.95				14.95	15	—	
Input Low Voltage Max. V _{IL}	0.5, 4.5	—	5	1.5				—	—	1.5	V
	1, 9	—	10	3				—	—	3	
	1.5, 13.5	—	15	4				—	—	4	
Input High Voltage Min. V _{IH}	0.5, 4.5	—	5	3.5				3.5	—	—	V
	1, 9	—	10	7				7	—	—	
	1.5, 13.5	—	15	11				11	—	—	
Input Current Max. I _{IN}	—	0, 18	18	±0.1	±0.1	±1	±1	—	±10 ⁻⁵	±0.1	μA



Fig. 2 - Definition of setup, hold, propagation delay, and removal times.

TRUTH TABLE FOR 1 OF 4 FLIP-FLOPS (Positive Logic)

INPUTS			OUTPUTS	
CLOCK	DATA	CLEAR	Q	\bar{Q}
	0	1	0	1
	1	1	1	0
	X	1	Q	\bar{Q}
X	X	0	0	1

1=High Level X=Don't Care 0=Low Level

CD40175B Types

DYNAMIC ELECTRICAL CHARACTERISTICS at TA = 25°C; input tr, tf = 20 ns, CL = 50 pF, RL = 200 kΩ

CHARACTERISTIC	TEST CONDITIONS VDD (V)	LIMITS			UNITS	
		MIN.	TYP.	MAX.		
Transition Time t _{THL} , t _{TLH}	5	—	100	200	ns	
	10	—	50	100		
	15	—	40	80		
Propagation Delay Time Clock to Q Output t _{PHL} , t _{PLH}	5	—	220	400		
	10	—	90	160		
	15	—	70	120		
Propagation Delay Time CLEAR to Q Output t _{PHL}	5	—	325	500		
	10	—	130	200		
	15	—	100	150		
Minimum Pulse Width Clock t _{WH}	5	—	110	250		
	10	—	45	100		
	15	—	35	75		
Clear t _{WL}	5	—	100	200		
	10	—	40	80		
	15	—	30	60		
Maximum Clock Frequency f _{CL}	5	2	4.5	—	MHz	
	10	5	11	—		
	15	6.5	14	—		
Maximum Clock Rise or Fall Time t _{rCL} , t _{fCL}	5	15	—	—	μs	
	10	15	—	—		
	15	15	—	—		
Minimum Data Setup Time t _{SU}	5	—	60	120	ns	
	10	—	25	50		
	15	—	20	40		
Minimum Data Hold Time t _H	5	—	40	80		
	10	—	20	40		
	15	—	15	30		
Minimum Clear Removal Time ‡ t _{REM}	5	—	125	250		
	10	—	50	100		
	15	—	40	80		
Input Capacitance C _{IN}	—	—	5	7.5		pF

**COMMERCIAL CMOS
HIGH VOLTAGE ICs**

‡ CLEAR signal must be high prior to positive-going transition of CLOCK pulse.

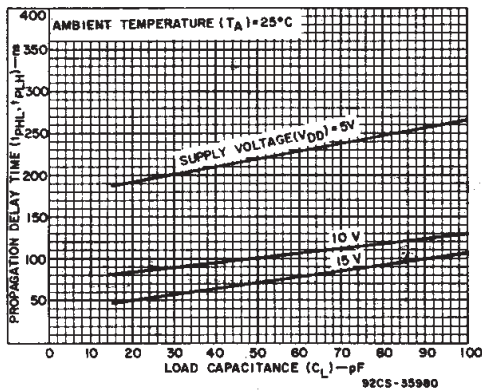

Fig. 3 - Typical propagation delay time (CLOCK to OUTPUT) as a function of load capacitance.

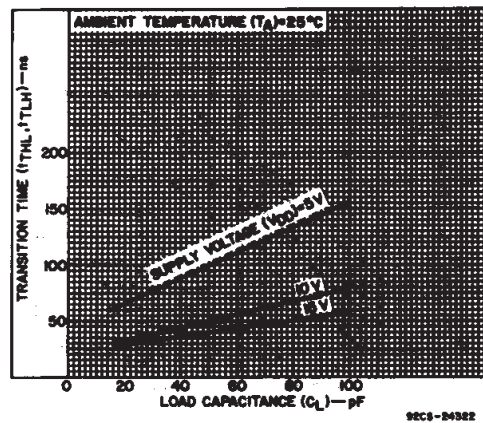

Fig. 4 - Typical transition time as a function of load capacitance.

CD40175B Types

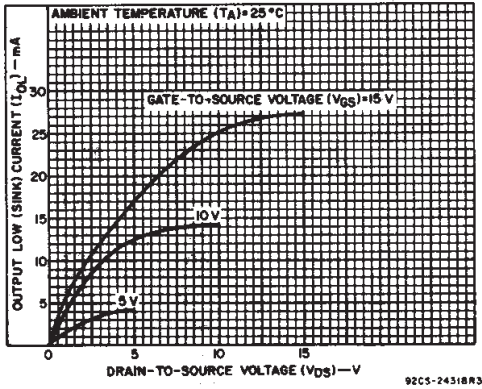

Fig. 5 - Typical output low (sink) current characteristics.

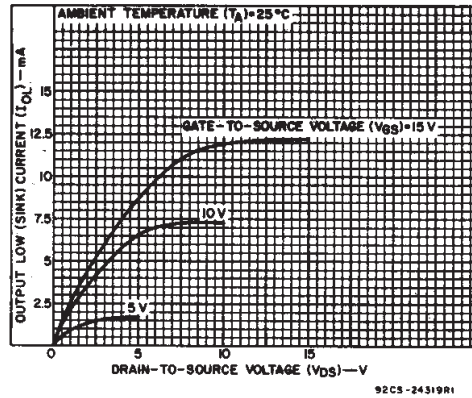

Fig. 6 - Minimum output low (sink) current characteristics.



Fig. 7 - Typical output high (source) current characteristics.

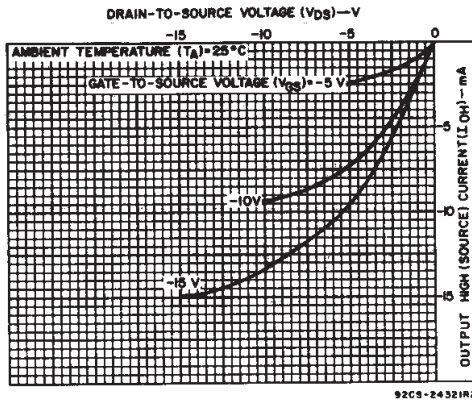

Fig. 8 - Minimum output high (source) current characteristics.



Fig. 9 - Typical dynamic power dissipation as a function of CLOCK frequency.

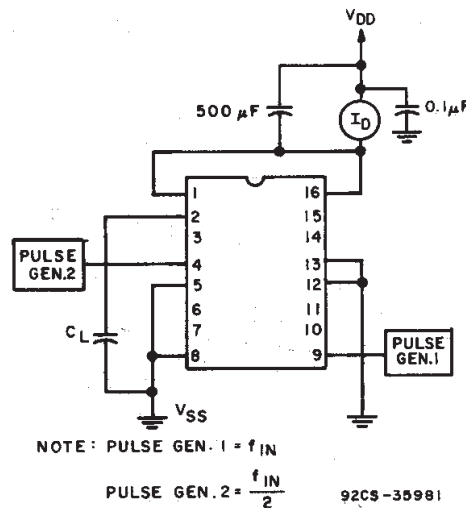

Fig. 10 - Dynamic power dissipation test circuit.

CD40175B Types

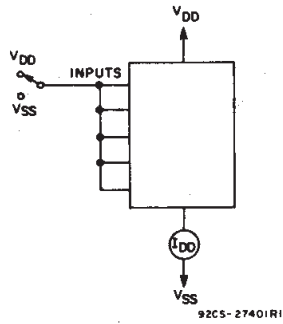

Fig. 11 - Quiescent device current test circuit.

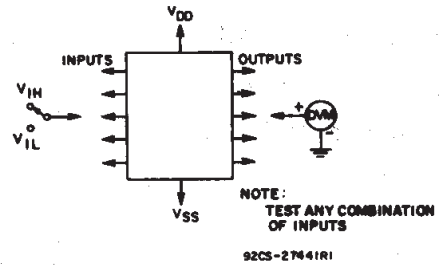

Fig. 12 - Noise immunity test circuit.

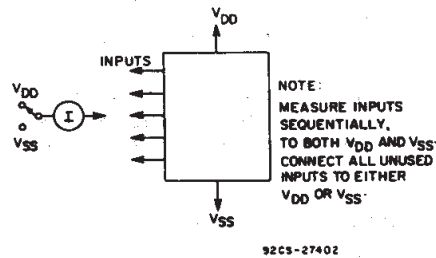
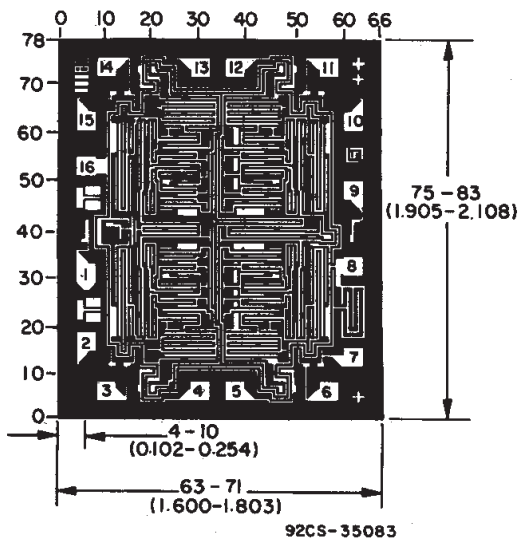

Fig. 13 - Input leakage current test circuit.



Dimensions and pad layout for CD40175BH.

Dimensions in parentheses are in millimeters and are derived from the basic inch dimensions as indicated. Grid graduations are in mils (10^{-3} inch).

PACKAGING INFORMATION

Orderable Device	Status ⁽¹⁾	Package Type	Package Drawing	Pins	Package Qty	Eco Plan ⁽²⁾	Lead/Ball Finish	MSL Peak Temp ⁽³⁾
CD40175BE	ACTIVE	PDIP	N	16	25	Pb-Free (RoHS)	CU NIPDAU	N / A for Pkg Type
CD40175BEE4	ACTIVE	PDIP	N	16	25	Pb-Free (RoHS)	CU NIPDAU	N / A for Pkg Type
CD40175BF3A	ACTIVE	CDIP	J	16	1	TBD	A42	N / A for Pkg Type
CD40175BM	ACTIVE	SOIC	D	16	40	Green (RoHS & no Sb/Br)	CU NIPDAU	Level-1-260C-UNLIM
CD40175BM96	ACTIVE	SOIC	D	16	2500	Green (RoHS & no Sb/Br)	CU NIPDAU	Level-1-260C-UNLIM
CD40175BM96E4	ACTIVE	SOIC	D	16	2500	Green (RoHS & no Sb/Br)	CU NIPDAU	Level-1-260C-UNLIM
CD40175BM96G4	ACTIVE	SOIC	D	16	2500	Green (RoHS & no Sb/Br)	CU NIPDAU	Level-1-260C-UNLIM
CD40175BME4	ACTIVE	SOIC	D	16	40	Green (RoHS & no Sb/Br)	CU NIPDAU	Level-1-260C-UNLIM
CD40175BMG4	ACTIVE	SOIC	D	16	40	Green (RoHS & no Sb/Br)	CU NIPDAU	Level-1-260C-UNLIM
CD40175BMT	ACTIVE	SOIC	D	16	250	Green (RoHS & no Sb/Br)	CU NIPDAU	Level-1-260C-UNLIM
CD40175BMTE4	ACTIVE	SOIC	D	16	250	Green (RoHS & no Sb/Br)	CU NIPDAU	Level-1-260C-UNLIM
CD40175BMTG4	ACTIVE	SOIC	D	16	250	Green (RoHS & no Sb/Br)	CU NIPDAU	Level-1-260C-UNLIM
CD40175BNSR	ACTIVE	SO	NS	16	2000	Green (RoHS & no Sb/Br)	CU NIPDAU	Level-1-260C-UNLIM
CD40175BNSRE4	ACTIVE	SO	NS	16	2000	Green (RoHS & no Sb/Br)	CU NIPDAU	Level-1-260C-UNLIM
CD40175BNSRG4	ACTIVE	SO	NS	16	2000	Green (RoHS & no Sb/Br)	CU NIPDAU	Level-1-260C-UNLIM
CD40175BPWR	ACTIVE	TSSOP	PW	16	2000	Green (RoHS & no Sb/Br)	CU NIPDAU	Level-1-260C-UNLIM
CD40175BPWRE4	ACTIVE	TSSOP	PW	16	2000	Green (RoHS & no Sb/Br)	CU NIPDAU	Level-1-260C-UNLIM
CD40175BPWRG4	ACTIVE	TSSOP	PW	16	2000	Green (RoHS & no Sb/Br)	CU NIPDAU	Level-1-260C-UNLIM
CD40175BW	OBSOLETE	WAFER SALE	YS	0		TBD	Call TI	Call TI

⁽¹⁾ The marketing status values are defined as follows:

ACTIVE: Product device recommended for new designs.

LIFEBUY: TI has announced that the device will be discontinued, and a lifetime-buy period is in effect.

NRND: Not recommended for new designs. Device is in production to support existing customers, but TI does not recommend using this part in a new design.

PREVIEW: Device has been announced but is not in production. Samples may or may not be available.

OBSOLETE: TI has discontinued the production of the device.

⁽²⁾ Eco Plan - The planned eco-friendly classification: Pb-Free (RoHS), Pb-Free (RoHS Exempt), or Green (RoHS & no Sb/Br) - please check <http://www.ti.com/productcontent> for the latest availability information and additional product content details.

TBD: The Pb-Free/Green conversion plan has not been defined.

Pb-Free (RoHS): TI's terms "Lead-Free" or "Pb-Free" mean semiconductor products that are compatible with the current RoHS requirements for all 6 substances, including the requirement that lead not exceed 0.1% by weight in homogeneous materials. Where designed to be soldered at high temperatures, TI Pb-Free products are suitable for use in specified lead-free processes.

Pb-Free (RoHS Exempt): This component has a RoHS exemption for either 1) lead-based flip-chip solder bumps used between the die and package, or 2) lead-based die adhesive used between the die and leadframe. The component is otherwise considered Pb-Free (RoHS compatible) as defined above.

Green (RoHS & no Sb/Br): TI defines "Green" to mean Pb-Free (RoHS compatible), and free of Bromine (Br) and Antimony (Sb) based flame retardants (Br or Sb do not exceed 0.1% by weight in homogeneous material)

⁽³⁾ MSL, Peak Temp. -- The Moisture Sensitivity Level rating according to the JEDEC industry standard classifications, and peak solder temperature.

Important Information and Disclaimer:The information provided on this page represents TI's knowledge and belief as of the date that it is provided. TI bases its knowledge and belief on information provided by third parties, and makes no representation or warranty as to the accuracy of such information. Efforts are underway to better integrate information from third parties. TI has taken and continues to take reasonable steps to provide representative and accurate information but may not have conducted destructive testing or chemical analysis on incoming materials and chemicals. TI and TI suppliers consider certain information to be proprietary, and thus CAS numbers and other limited information may not be available for release.

In no event shall TI's liability arising out of such information exceed the total purchase price of the TI part(s) at issue in this document sold by TI to Customer on an annual basis.

TAPE AND REEL INFORMATION
REEL DIMENSIONS

TAPE DIMENSIONS

A0	Dimension designed to accommodate the component width
B0	Dimension designed to accommodate the component length
K0	Dimension designed to accommodate the component thickness
W	Overall width of the carrier tape
P1	Pitch between successive cavity centers

TAPE AND REEL INFORMATION

*All dimensions are nominal

Device	Package Type	Package Drawing	Pins	SPQ	Reel Diameter (mm)	Reel Width W1 (mm)	A0 (mm)	B0 (mm)	K0 (mm)	P1 (mm)	W (mm)	Pin1 Quadrant
CD40175BM96	SOIC	D	16	2500	330.0	16.4	6.5	10.3	2.1	8.0	16.0	Q1
CD40175BNSR	SO	NS	16	2000	330.0	16.4	8.2	10.5	2.5	12.0	16.0	Q1
CD40175BPWR	TSSOP	PW	16	2000	330.0	12.4	6.9	5.6	1.6	8.0	12.0	Q1

TAPE AND REEL BOX DIMENSIONS



*All dimensions are nominal

Device	Package Type	Package Drawing	Pins	SPQ	Length (mm)	Width (mm)	Height (mm)
CD40175BM96	SOIC	D	16	2500	333.2	345.9	28.6
CD40175BNSR	SO	NS	16	2000	367.0	367.0	38.0
CD40175BPWR	TSSOP	PW	16	2000	367.0	367.0	35.0

J (R-GDIP-T**)

14 LEADS SHOWN

CERAMIC DUAL IN-LINE PACKAGE



DIM \ PINS **	14	16	18	20
A	0.300 (7,62) BSC	0.300 (7,62) BSC	0.300 (7,62) BSC	0.300 (7,62) BSC
B MAX	0.785 (19,94)	.840 (21,34)	0.960 (24,38)	1.060 (26,92)
B MIN	—	—	—	—
C MAX	0.300 (7,62)	0.300 (7,62)	0.310 (7,87)	0.300 (7,62)
C MIN	0.245 (6,22)	0.245 (6,22)	0.220 (5,59)	0.245 (6,22)



4040083/F 03/03

- NOTES:
- All linear dimensions are in inches (millimeters).
 - This drawing is subject to change without notice.
 - This package is hermetically sealed with a ceramic lid using glass frit.
 - Index point is provided on cap for terminal identification only on press ceramic glass frit seal only.
 - Falls within MIL STD 1835 GDIP1-T14, GDIP1-T16, GDIP1-T18 and GDIP1-T20.

N (R-PDIP-T**)

PLASTIC DUAL-IN-LINE PACKAGE

16 PINS SHOWN



- NOTES:
- A. All linear dimensions are in inches (millimeters).
 - B. This drawing is subject to change without notice.
 - Falls within JEDEC MS-001, except 18 and 20 pin minimum body length (Dim A).
 - The 20 pin end lead shoulder width is a vendor option, either half or full width.

D (R-PDSO-G16)

PLASTIC SMALL OUTLINE



4040047-6/M 06/11

- NOTES:
- A. All linear dimensions are in inches (millimeters).
 - B. This drawing is subject to change without notice.
 -  C. Body length does not include mold flash, protrusions, or gate burrs. Mold flash, protrusions, or gate burrs shall not exceed 0.006 (0,15) each side.
 -  D. Body width does not include interlead flash. Interlead flash shall not exceed 0.017 (0,43) each side.
 - E. Reference JEDEC MS-012 variation AC.

D (R-PDSO-G16)

PLASTIC SMALL OUTLINE



- NOTES:
- A. All linear dimensions are in millimeters.
 - B. This drawing is subject to change without notice.
 - C. Publication IPC-7351 is recommended for alternate designs.
 - D. Laser cutting apertures with trapezoidal walls and also rounding corners will offer better paste release. Customers should contact their board assembly site for stencil design recommendations. Refer to IPC-7525 for other stencil recommendations.
 - E. Customers should contact their board fabrication site for solder mask tolerances between and around signal pads.

PW (R-PDSO-G16)

PLASTIC SMALL OUTLINE



4040064-4/G 02/11

- NOTES:
- A. All linear dimensions are in millimeters. Dimensioning and tolerancing per ASME Y14.5M-1994.
 - B. This drawing is subject to change without notice.
 - C. Body length does not include mold flash, protrusions, or gate burrs. Mold flash, protrusions, or gate burrs shall not exceed 0,15 each side.
 - D. Body width does not include interlead flash. Interlead flash shall not exceed 0,25 each side.
 - E. Falls within JEDEC MO-153

PW (R-PDSO-G16)

PLASTIC SMALL OUTLINE

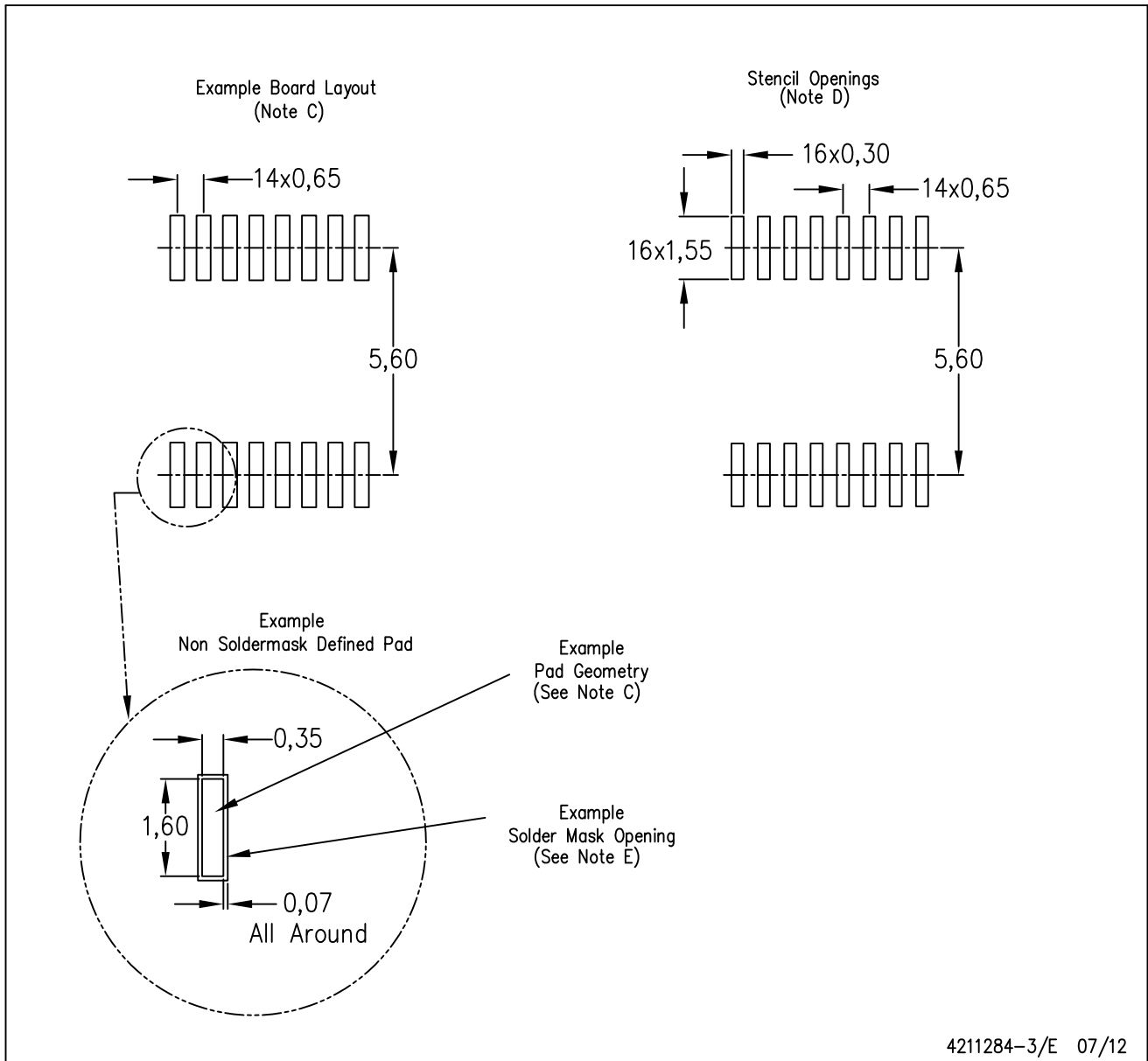

4211284-3/E 07/12

- NOTES:
- All linear dimensions are in millimeters.
 - This drawing is subject to change without notice.
 - Publication IPC-7351 is recommended for alternate designs.
 - Laser cutting apertures with trapezoidal walls and also rounding corners will offer better paste release. Customers should contact their board assembly site for stencil design recommendations. Refer to IPC-7525 for other stencil recommendations.
 - Customers should contact their board fabrication site for solder mask tolerances between and around signal pads.

MECHANICAL DATA

NS (R-PDSO-G**)

PLASTIC SMALL-OUTLINE PACKAGE

14-PINS SHOWN



- NOTES:
- A. All linear dimensions are in millimeters.
 - B. This drawing is subject to change without notice.
 - C. Body dimensions do not include mold flash or protrusion, not to exceed 0,15.

IMPORTANT NOTICE

Texas Instruments Incorporated and its subsidiaries (TI) reserve the right to make corrections, enhancements, improvements and other changes to its semiconductor products and services per JESD46, latest issue, and to discontinue any product or service per JESD48, latest issue. Buyers should obtain the latest relevant information before placing orders and should verify that such information is current and complete. All semiconductor products (also referred to herein as "components") are sold subject to TI's terms and conditions of sale supplied at the time of order acknowledgment.

TI warrants performance of its components to the specifications applicable at the time of sale, in accordance with the warranty in TI's terms and conditions of sale of semiconductor products. Testing and other quality control techniques are used to the extent TI deems necessary to support this warranty. Except where mandated by applicable law, testing of all parameters of each component is not necessarily performed.

TI assumes no liability for applications assistance or the design of Buyers' products. Buyers are responsible for their products and applications using TI components. To minimize the risks associated with Buyers' products and applications, Buyers should provide adequate design and operating safeguards.

TI does not warrant or represent that any license, either express or implied, is granted under any patent right, copyright, mask work right, or other intellectual property right relating to any combination, machine, or process in which TI components or services are used. Information published by TI regarding third-party products or services does not constitute a license to use such products or services or a warranty or endorsement thereof. Use of such information may require a license from a third party under the patents or other intellectual property of the third party, or a license from TI under the patents or other intellectual property of TI.

Reproduction of significant portions of TI information in TI data books or data sheets is permissible only if reproduction is without alteration and is accompanied by all associated warranties, conditions, limitations, and notices. TI is not responsible or liable for such altered documentation. Information of third parties may be subject to additional restrictions.

Resale of TI components or services with statements different from or beyond the parameters stated by TI for that component or service voids all express and any implied warranties for the associated TI component or service and is an unfair and deceptive business practice. TI is not responsible or liable for any such statements.

Buyer acknowledges and agrees that it is solely responsible for compliance with all legal, regulatory and safety-related requirements concerning its products, and any use of TI components in its applications, notwithstanding any applications-related information or support that may be provided by TI. Buyer represents and agrees that it has all the necessary expertise to create and implement safeguards which anticipate dangerous consequences of failures, monitor failures and their consequences, lessen the likelihood of failures that might cause harm and take appropriate remedial actions. Buyer will fully indemnify TI and its representatives against any damages arising out of the use of any TI components in safety-critical applications.

In some cases, TI components may be promoted specifically to facilitate safety-related applications. With such components, TI's goal is to help enable customers to design and create their own end-product solutions that meet applicable functional safety standards and requirements. Nonetheless, such components are subject to these terms.

No TI components are authorized for use in FDA Class III (or similar life-critical medical equipment) unless authorized officers of the parties have executed a special agreement specifically governing such use.

Only those TI components which TI has specifically designated as military grade or "enhanced plastic" are designed and intended for use in military/aerospace applications or environments. Buyer acknowledges and agrees that any military or aerospace use of TI components which have **not** been so designated is solely at the Buyer's risk, and that Buyer is solely responsible for compliance with all legal and regulatory requirements in connection with such use.

TI has specifically designated certain components which meet ISO/TS16949 requirements, mainly for automotive use. Components which have not been so designated are neither designed nor intended for automotive use; and TI will not be responsible for any failure of such components to meet such requirements.

Products

Audio	www.ti.com/audio
Amplifiers	amplifier.ti.com
Data Converters	dataconverter.ti.com
DLP® Products	www.dlp.com
DSP	dsp.ti.com
Clocks and Timers	www.ti.com/clocks
Interface	interface.ti.com
Logic	logic.ti.com
Power Mgmt	power.ti.com
Microcontrollers	microcontroller.ti.com
RFID	www.ti-rfid.com
OMAP Applications Processors	www.ti.com/omap
Wireless Connectivity	www.ti.com/wirelessconnectivity

Applications

Automotive and Transportation	www.ti.com/automotive
Communications and Telecom	www.ti.com/communications
Computers and Peripherals	www.ti.com/computers
Consumer Electronics	www.ti.com/consumer-apps
Energy and Lighting	www.ti.com/energy
Industrial	www.ti.com/industrial
Medical	www.ti.com/medical
Security	www.ti.com/security
Space, Avionics and Defense	www.ti.com/space-avionics-defense
Video and Imaging	www.ti.com/video

TI E2E Community

e2e.ti.com



Стандарт Электрон Связь

Мы молодая и активно развивающаяся компания в области поставок электронных компонентов. Мы поставляем электронные компоненты отечественного и импортного производства напрямую от производителей и с крупнейших складов мира.

Благодаря сотрудничеству с мировыми поставщиками мы осуществляем комплексные и плановые поставки широчайшего спектра электронных компонентов.

Собственная эффективная логистика и склад в обеспечивает надежную поставку продукции в точно указанные сроки по всей России.

Мы осуществляем техническую поддержку нашим клиентам и предпродажную проверку качества продукции. На все поставляемые продукты мы предоставляем гарантию .

Осуществляем поставки продукции под контролем ВП МО РФ на предприятия военно-промышленного комплекса России , а также работаем в рамках 275 ФЗ с открытием отдельных счетов в уполномоченном банке. Система менеджмента качества компании соответствует требованиям ГОСТ ISO 9001.

Минимальные сроки поставки, гибкие цены, неограниченный ассортимент и индивидуальный подход к клиентам являются основой для выстраивания долгосрочного и эффективного сотрудничества с предприятиями радиоэлектронной промышленности, предприятиями ВПК и научно-исследовательскими институтами России.

С нами вы становитесь еще успешнее!

Наши контакты:

Телефон: +7 812 627 14 35

Электронная почта: sales@st-electron.ru

Адрес: 198099, Санкт-Петербург,
Промышленная ул, дом № 19, литера Н,
помещение 100-Н Офис 331