



### Typical Applications

The HMC682LP6C(E) is Ideal for:

- Cellular/3G & LTE/WiMAX/4G
- Basestations & Repeaters
- GSM, CDMA & OFDM
- Dual Density Receivers

### Features

- High Input IP3: +25 dBm
- Conversion Gain: 6 dB
- Low LO Drive: 0 dBm
- High Channel Isolation
- 40 Lead 6x6mm SMT Package: 36mm<sup>2</sup>

### Functional Diagram

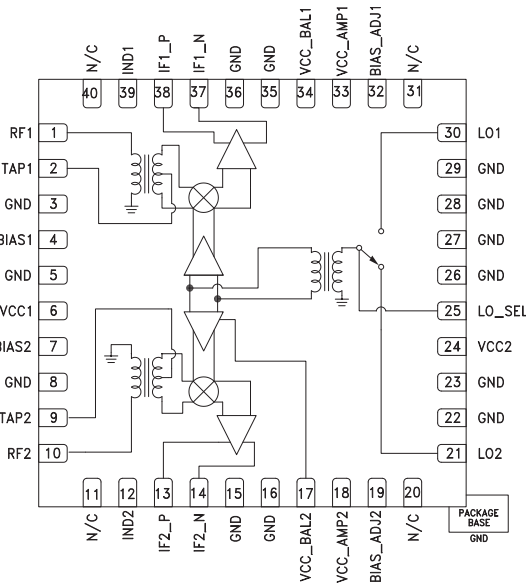

### General Description

The HMC682LP6C(E) is a high linearity, dual channel downconverter with integrated LO amplifier in a 6x6 SMT QFN package covering 1.7 - 2.2 GHz. Excellent input IP3 performance of +25 dBm for down conversion is provided for 3G & 4G GSM/CDMA applications at an LO drive of 0 dBm. With an input 1 dB compression of +15 dBm, the RF port will accept a wide range of input signal levels. Conversion gain is 6 dB typical. The 60 - 400 MHz IF frequency response will satisfy various GSM/CDMA receive frequency plans.

### Electrical Specifications, $T_A = +25\text{ }^\circ\text{C}$ , $IF = 200\text{ MHz}$ , $LO = 0\text{ dBm}$

$V_{cc1, 2} = V_{cc\_BAL1, 2} = V_{cc\_AMP1, 2}$  [1] =  $V_{cc\_IF1P, N} = V_{cc\_IF2P, N} = +5V$ ,  $BIAS1, 2 = +2.5V$

Parameter	Min.	Typ.	Max.	Units
Frequency Range, RF	1.7 - 2.2			GHz
Frequency Range, LO	1.4 - 2.0			GHz
Frequency Range, IF	0.06 - 0.40			GHz
Conversion Gain	4	6		dB
Noise Figure (SSB)		12		dB
LO to RF Isolation	17	25		dB
LO to IF Isolation	15	22		dB
RF to IF Isolation	15	30		dB
IP3 (Input)		25		dBm
1 dB Compression (Input)		15		dBm
Channel to Channel Isolation		55		dB
LO Drive Input Level (Typical)	-3 to +3			dBm
Supply Current (I <sub>cc</sub> )		450	550	mA

[1] See application circuit [2] Unless otherwise noted all measurements with low side LO & IF = 200 MHz.

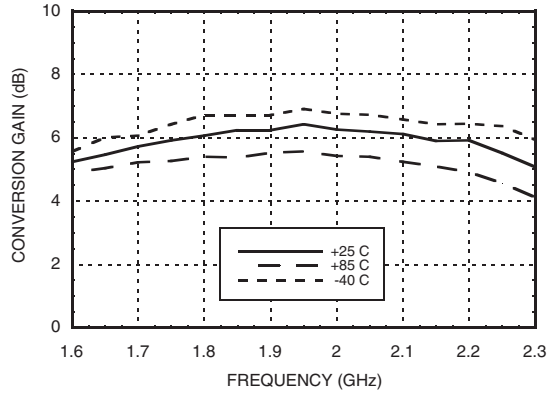
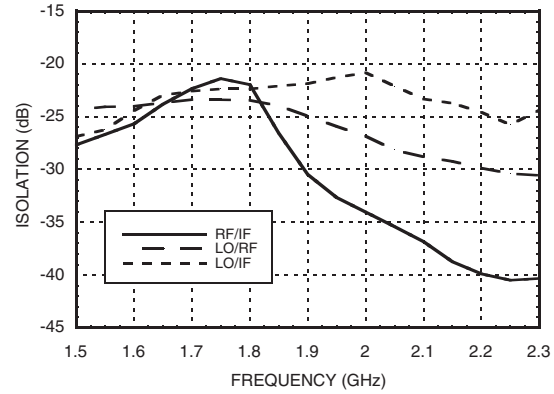
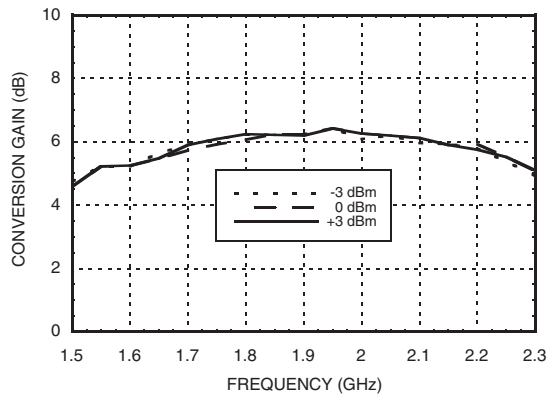
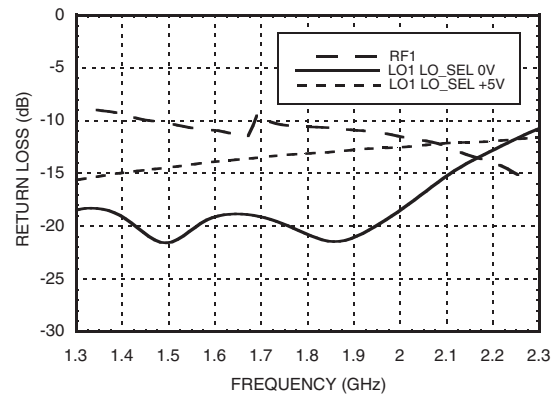
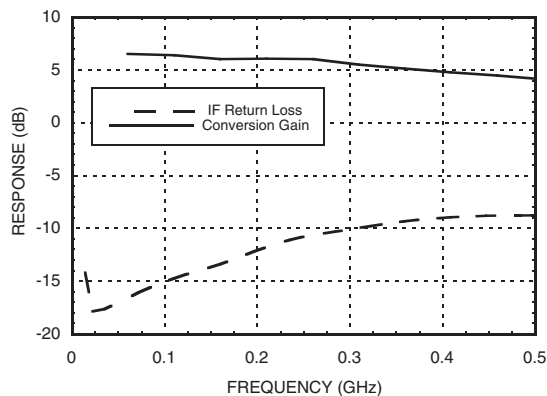
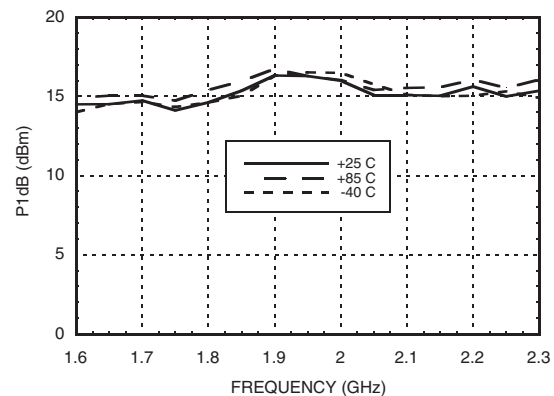
**HIGH IP3 DUAL CHANNEL  
DOWNCONVERTER w/ LO SWITCH, 1.7 - 2.2 GHz**
**Single Channel:  
Conversion Gain vs. Temperature**

**Single Channel: Isolation**

**Single Channel:  
Conversion Gain vs. LO Drive**

**Single Channel: Return Loss**

**Single Channel: IF Bandwidth**

**Single Channel:  
Input P1dB vs. Temperature**

Information furnished by Analog Devices is believed to be accurate and reliable. However, no responsibility is assumed by Analog Devices for its use, nor for any infringements of patents or other rights of third parties that may result from its use. Specifications subject to change without notice. No license is granted by implication or otherwise under any patent or patent rights of Analog Devices. Trademarks and registered trademarks are the property of their respective owners.

For price, delivery, and to place orders: Analog Devices, Inc., One Technology Way, P.O. Box 9106, Norwood, MA 02062-9106 Phone: 781-329-4700 • Order online at [www.analog.com](http://www.analog.com) Application Support: Phone: 1-800-ANALOG-D



**HIGH IP3 DUAL CHANNEL  
DOWNCONVERTER w/ LO SWITCH, 1.7 - 2.2 GHz**

9

MIXERS - DOWNCONVERTERS - SMT

**Single Channel: Input IP3 vs. LO Drive**

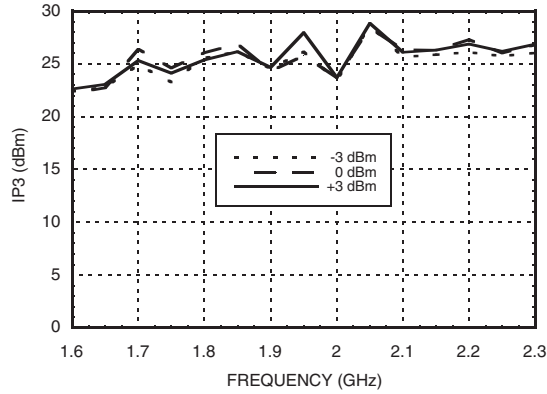

**Single Channel:  
Input IP3 vs. Temperature**

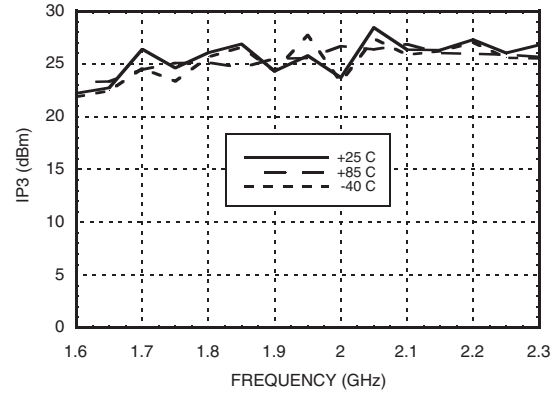

**Dual Channel:  
Channel to Channel Isolation<sup>[1]</sup>**

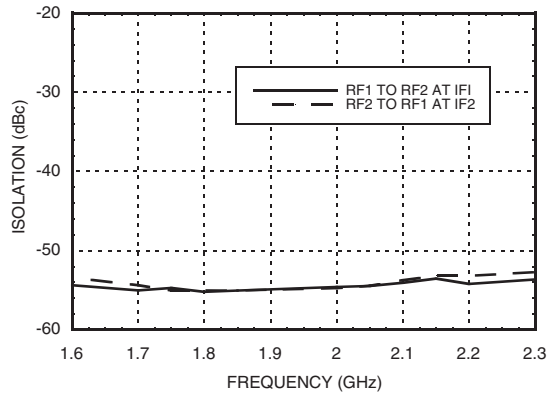

**Dual Channel: LO1 to LO2 Isolation<sup>[2]</sup>**

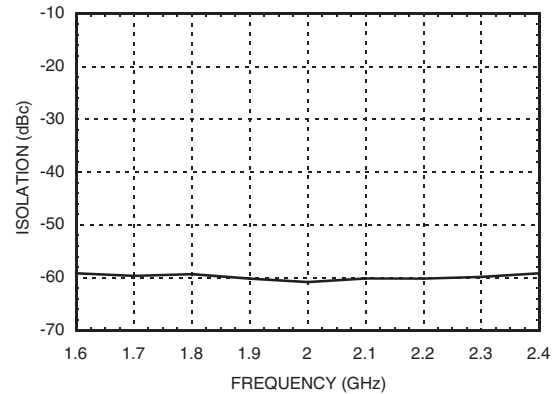

**Noise Figure vs. Temperature**

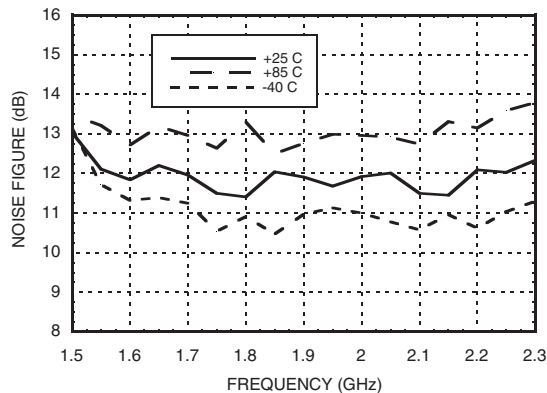

[1] For 1900 MHz, RF1 = 1900 MHz @ 0 dBm, RF2 = 1901 MHz @ 0 dBm, LO = 1700 MHz @ 0 dBm, IF2 terminated with 50 Ohms. Channel isolation is the dBc difference at IF1 port between the fundamental tone @ 200 MHz and the leakage tone at 201 MHz.

[2] For 1900 MHz, LO1 = 1700 MHz @ 0 dBm, LO2 = 1699 MHz @ 0 dBm, LO1 is selected, RF1 = RF2 = 1900 MHz @ 0 dBm, IF2 terminated with 50 Ohms. LO1-LO2 isolation is the dBc difference measured at the IF1 port between the fundamental tone at 200 MHz and the leakage tone at 201 MHz.



**HIGH IP3 DUAL CHANNEL  
DOWNCONVERTER w/ LO SWITCH, 1.7 - 2.2 GHz**

**+2RF -2LO Response vs. Temperature [3]**

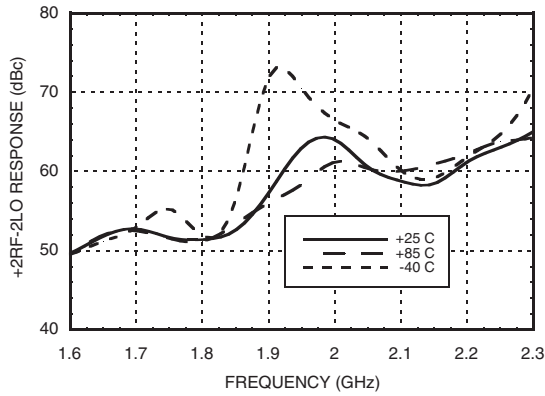

**+2RF -2LO Response vs. LO Drive [3]**

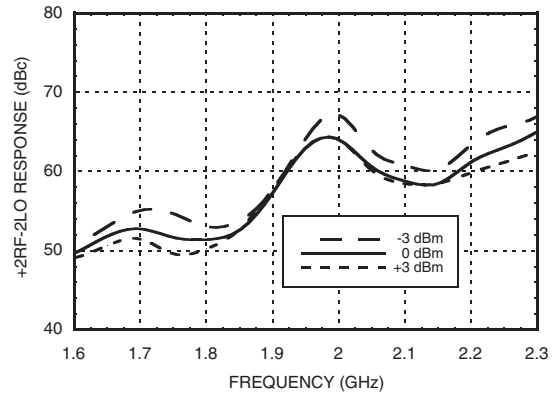

**+3RF -3LO Response vs. Temperature [3]**

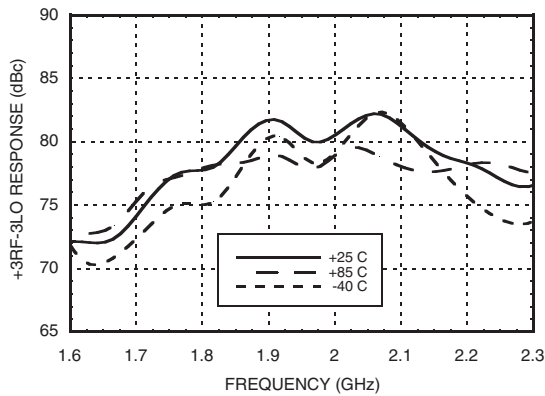

**+3RF -3LO Response vs. LO Drive [3]**

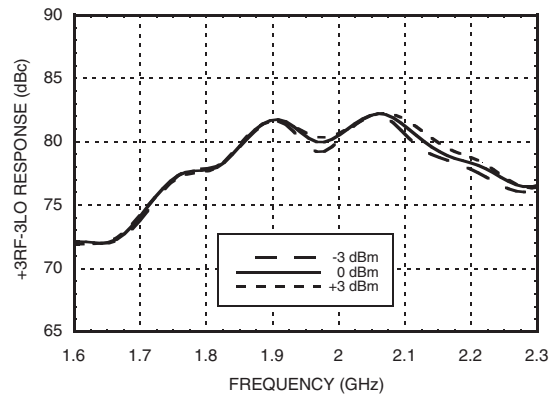

[3] Referenced to RF input power @ 0 dBm

**HIGH IP3 DUAL CHANNEL  
DOWNCONVERTER w/ LO SWITCH, 1.7 - 2.2 GHz**
**Harmonics of LO**

LO Freq. (GHz)	nLO Spur @ RF Port			
	1	2	3	4
1.4	25	29	38	19
1.5	24	28	31	21
1.6	25	23	30	21
1.7	26	19	38	14
1.8	29	16	43	16
1.9	31	15	40	19
2.0	32	14	43	22

LO = 0 dBm  
All values in dBc below input LO level measured at RF port.

**MxN Spurious @ IF Port**

mRF	nLO				
	0	1	2	3	4
0	xx	39	20	46	47
1	35	0	40	24	66
2	72	61	63	54	83
3	107	73	90	70	101
4	116	125	114	106	108

RF Freq. = 1.9 GHz @ -5 dBm  
LO Freq. = 1.7 GHz @ 0 dBm  
All values in dBc below IF power level (1RF - 1LO).

**Typical Supply Current vs. Vdd**

Vcc	Icc (mA)
4.75	415
5.00	450
5.25	490

Downconverter will operate over full voltage range shown above.

**Truth Table**

LO_SEL (V)	LO Signal Path
0	LO1
5	LO2



## HIGH IP3 DUAL CHANNEL DOWNCONVERTER w/ LO SWITCH, 1.7 - 2.2 GHz

### Absolute Maximum Ratings

RF / IF Input (Vcc= +5V)	+15 dBm
LO Drive (Vcc= +5V)	+6 dBm
Vcc (LO or IF)	5.5V
Channel Temperature	12.5°C
Continuous Pdiss (T = 85°C) (derate 110.53 mW/°C above 85°C)	4.42 W
Thermal Resistance (channel to ground paddle)	9.05 °C/W
Storage Temperature	-65 to 150°C
Operating Temperature	-40 to +85 °C



ELECTROSTATIC SENSITIVE DEVICE  
OBSERVE HANDLING PRECAUTIONS

9

### Outline Drawing

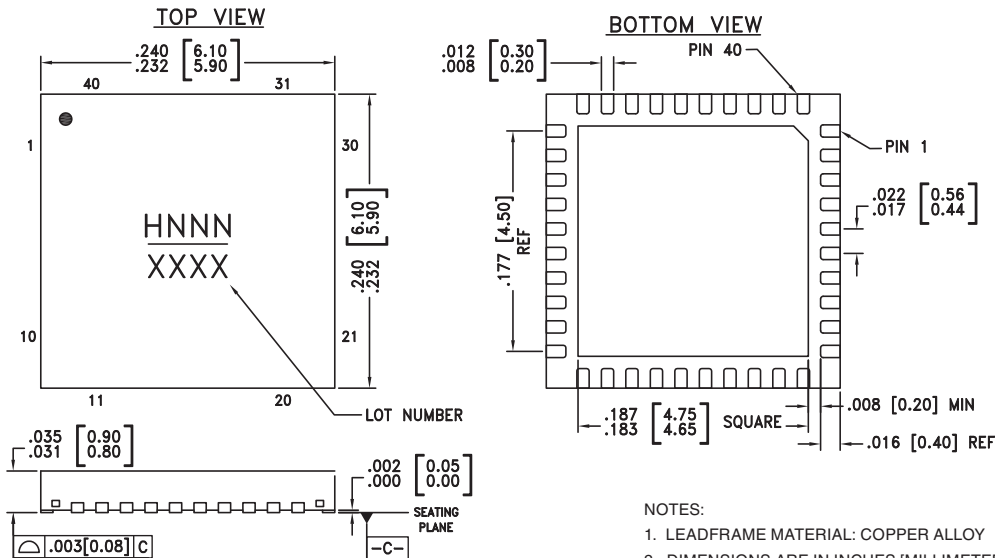

### Package Information

Part Number	Package Body Material	Lead Finish	MSL Rating	Package Marking <sup>[3]</sup>
HMC682LP6C	Low Stress Injection Molded Plastic	Sn/Pb Solder	MSL1 <sup>[1]</sup>	H682 XXXX
HMC682LP6CE	RoHS-compliant Low Stress Injection Molded Plastic	100% matte Sn	MSL1 <sup>[2]</sup>	H682 XXXX





[1] Max peak reflow temperature of 235 °C

[2] Max peak reflow temperature of 260 °C

[3] 4-Digit lot number XXXX

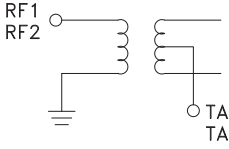

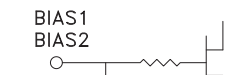
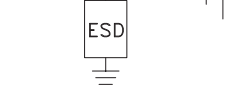
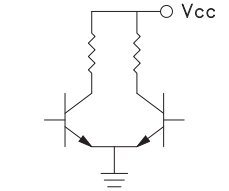
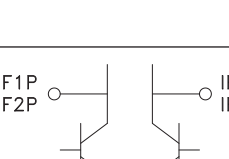
### Pin Descriptions

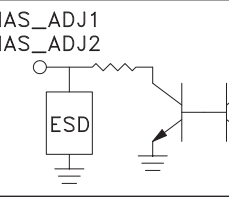
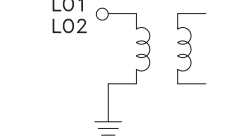
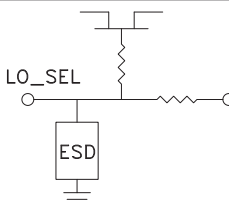
Pin Number	Function	Description	Interface Schematic
1, 10	RF1, RF2	These are the RF inputs of the mixers. See application circuit for the off-chip matching components	
2, 9	TAP1, TAP2	These are the center taps of the internal RF baluns. Connect these pins to the AC ground via external capacitors. See application circuit.	
3, 5, 8, 15, 16, 22, 23, 26 - 29, 36, 35	GND	These pins must be connected to RF ground.	
4, 7	BIAS1, BIAS2	Bias pins for mixer cores. See application circuit for the nominal value.	
6, 17, 18, 24, 33, 34	Vcc1, Vcc_BAL2, Vcc_AMP2, Vcc2, Vcc_AMP1, Vcc_BAL1	Power supply voltage pins. See application circuit for required external components.	
11, 20, 31, 40	N/C	No Connection required. These pins may be connected to RF GND without affecting performance.	
12, 39	IND1, IND2	Current source inductors for IF amplifiers.	
13, 14, 38, 37	IF2P, IF2N, IF1P, IF1N	Differential IF outputs and DC BIAS for IF Amps.	
19, 32	BIAS_ADJ1, BIAS_ADJ2	Adjusts LO buffer amplifies current via external resistor. See application circuit.	
21, 30	LO2, LO1	These are LO inputs of the mixers. See application circuit for off-chip matching components.	
25	LO_SEL	Control voltage for LO1 or LO2 selection. LO1 is selected when LO SEL is set low. LO2 is selected when LO SEL is set high. See application circuit and truth table for low and high voltage levels.	



**HIGH IP3 DUAL CHANNEL  
DOWNCONVERTER w/ LO SWITCH, 1.7 - 2.2 GHz**

**Evaluation PCB**

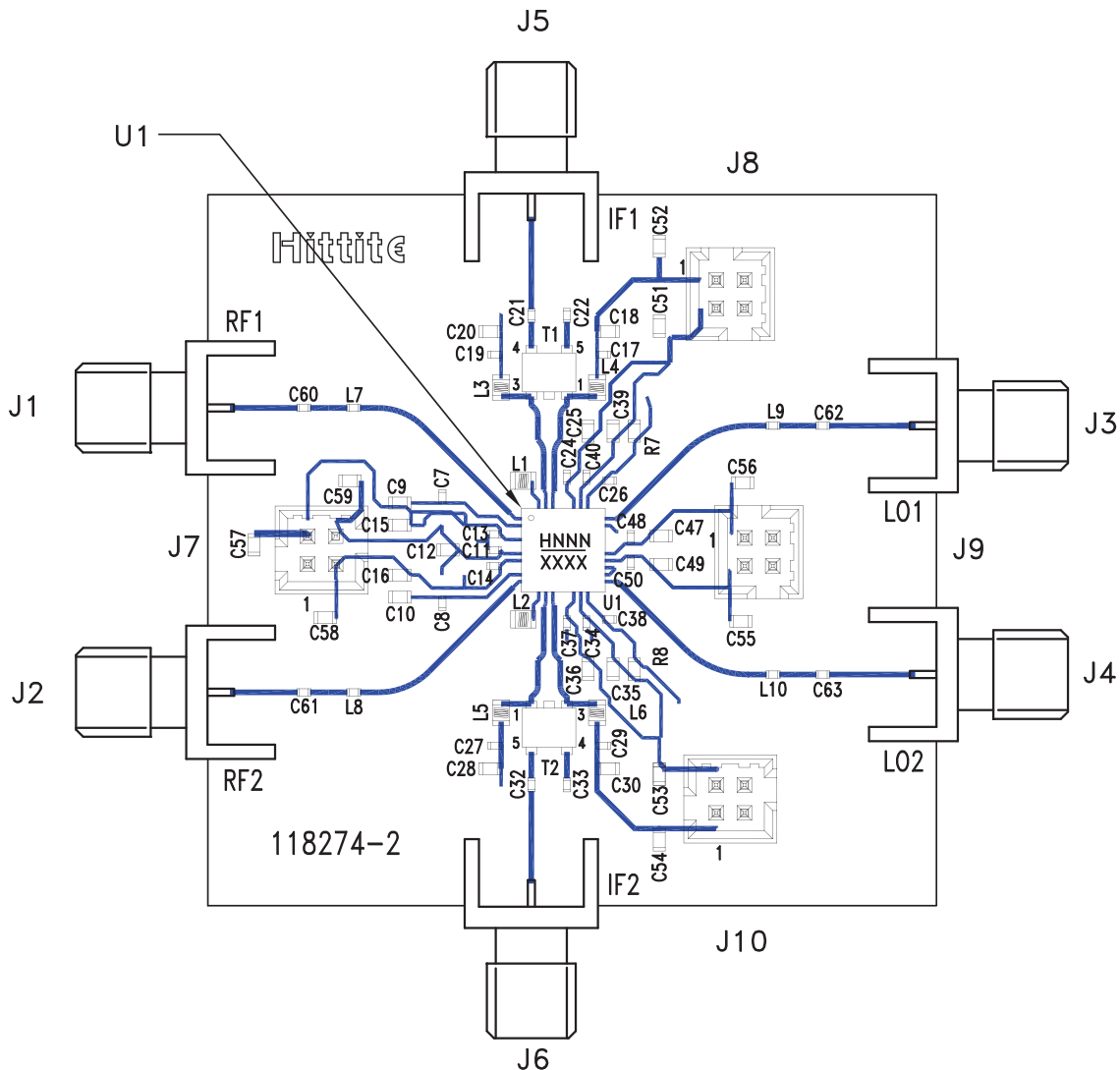

The circuit board used in the final application should use RF circuit design techniques. Signal lines should have 50 Ohm impedance while the package ground leads and exposed paddle should be connected directly to the ground plane similar to that shown. A sufficient number of via holes should be used to connect the top and bottom ground planes. The evaluation circuit board shown is available from Hittite upon request.

Information furnished by Analog Devices is believed to be accurate and reliable. However, no responsibility is assumed by Analog Devices for its use, nor for any infringements of patents or other rights of third parties that may result from its use. Specifications subject to change without notice. No license is granted by implication or otherwise under any patent or patent rights of Analog Devices. Trademarks and registered trademarks are the property of their respective owners.

For price, delivery, and to place orders: Analog Devices, Inc., One Technology Way, P.O. Box 9106, Norwood, MA 02062-9106 Phone: 781-329-4700 • Order online at [www.analog.com](http://www.analog.com) Application Support: Phone: 1-800-ANALOG-D



**HIGH IP3 DUAL CHANNEL  
DOWNCONVERTER w/ LO SWITCH, 1.7 - 2.2 GHz**
**List of Materials for Evaluation PCB 119925 [1]**

Item	Description
J1 - J6	PCB Mount SMA Connector
J7 - J10	2mm Vertical Molex 8pc Connector
L1, L2	51 nH Inductor, 0603 Pkg.
L3 - L6	390 nH Inductor, 0603 Pkg.
L7 - L10	2.2 nH Inductor, 0402 Pkg.
C7, C8, C26, C38	22 pF Capacitor, 0402 Pkg.
C9, C10	10 nF Capacitor, 0603 Pkg.
C11, C17, C19, C24, C27, C29, C34, C37, C40, C48, C50	1 nF Capacitor, 0402 Pkg.
C12, C15, C16, C18, C20, C25, C28, C30, C35, C36, C39, C47, C49	0.1 $\mu$ F Capacitor, 0603 Pkg.
C13, C14, C60 - C63	100 pF Capacitor, 0402 Pkg.
C21, C22, C32, C33	0.01 $\mu$ F Capacitor, 0402 Pkg.
C51 - C59	0.47 $\mu$ F Capacitor, 0603 Pkg.
R7, R8	330 Ohm Resistor, 0603 Pkg.
T1, T2	1:1 Transformer - Tyco ETC1-1T
U1	HMC682LP6C(E)
PCB [2]	118274 Evaluation PCB

[1] Reference this number when ordering complete evaluation PCB

[2] Circuit Board Material: Arlon-25FR and FR4



**HIGH IP3 DUAL CHANNEL  
DOWNCONVERTER w/ LO SWITCH, 1.7 - 2.2 GHz**

**Application Circuit**

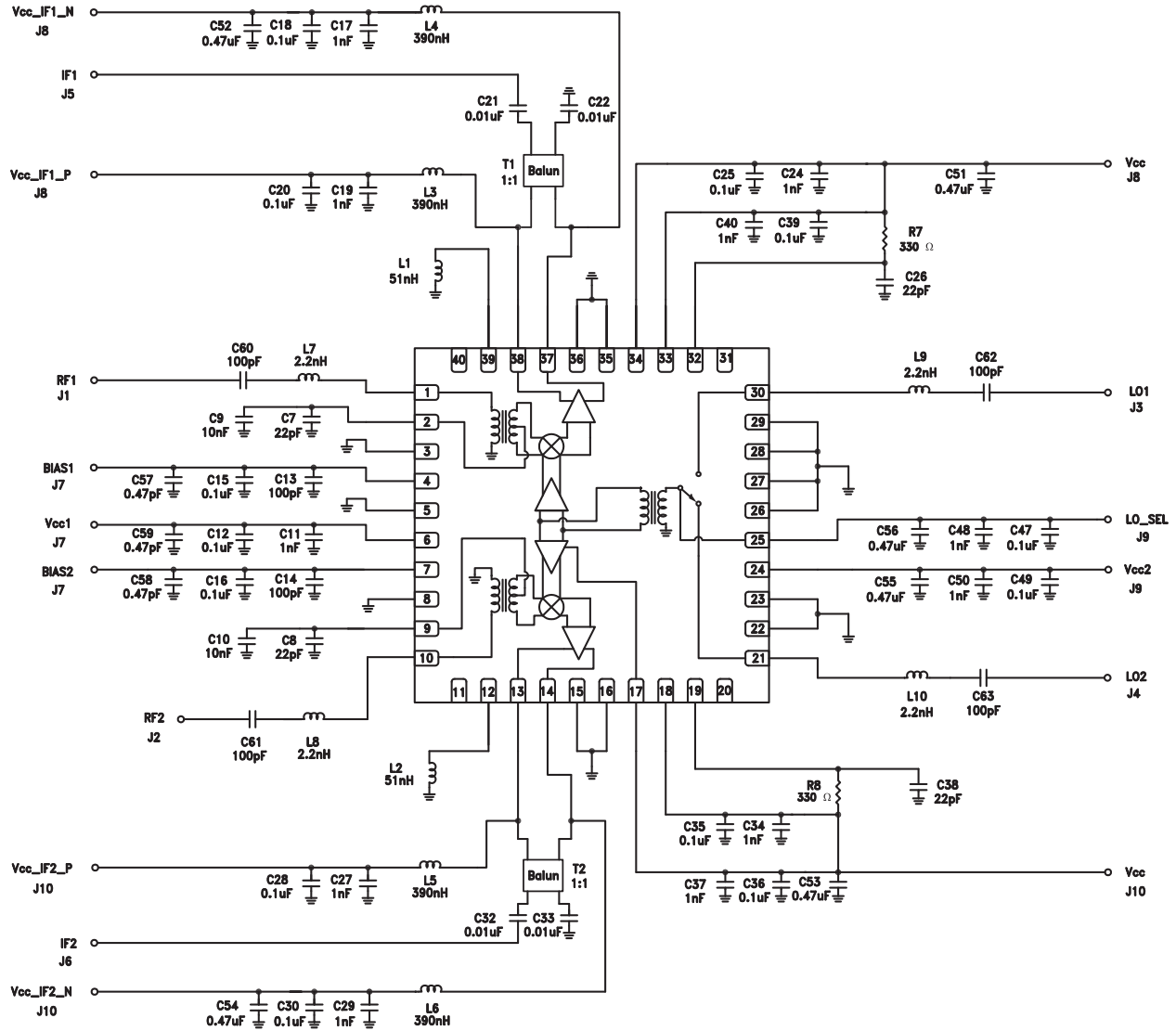

Information furnished by Analog Devices is believed to be accurate and reliable. However, no responsibility is assumed by Analog Devices for its use, nor for any infringements of patents or other rights of third parties that may result from its use. Specifications subject to change without notice. No license is granted by implication or otherwise under any patent or patent rights of Analog Devices. Trademarks and registered trademarks are the property of their respective owners.

For price, delivery, and to place orders: Analog Devices, Inc., One Technology Way, P.O. Box 9106, Norwood, MA 02062-9106 Phone: 781-329-4700 • Order online at [www.analog.com](http://www.analog.com) Application Support: Phone: 1-800-ANALOG-D



**Стандарт  
Электрон  
Связь**

Мы молодая и активно развивающаяся компания в области поставок электронных компонентов. Мы поставляем электронные компоненты отечественного и импортного производства напрямую от производителей и с крупнейших складов мира.

Благодаря сотрудничеству с мировыми поставщиками мы осуществляем комплексные и плановые поставки широчайшего спектра электронных компонентов.

Собственная эффективная логистика и склад в обеспечивает надежную поставку продукции в точно указанные сроки по всей России.

Мы осуществляем техническую поддержку нашим клиентам и предпродажную проверку качества продукции. На все поставляемые продукты мы предоставляем гарантию .

Осуществляем поставки продукции под контролем ВП МО РФ на предприятия военно-промышленного комплекса России , а также работаем в рамках 275 ФЗ с открытием отдельных счетов в уполномоченном банке. Система менеджмента качества компании соответствует требованиям ГОСТ ISO 9001.

Минимальные сроки поставки, гибкие цены, неограниченный ассортимент и индивидуальный подход к клиентам являются основой для выстраивания долгосрочного и эффективного сотрудничества с предприятиями радиоэлектронной промышленности, предприятиями ВПК и научно-исследовательскими институтами России.

С нами вы становитесь еще успешнее!

**Наши контакты:**

**Телефон:** +7 812 627 14 35

**Электронная почта:** [sales@st-electron.ru](mailto:sales@st-electron.ru)

**Адрес:** 198099, Санкт-Петербург,  
Промышленная ул, дом № 19, литера Н,  
помещение 100-Н Офис 331